

# Keysight M9420A VXT Vector Transceiver

Notice: This document contains references to Agilent. Please note that Agilent's Test and Measurement business has become Keysight Technologies. For more information, go to [www.keysight.com](http://www.keysight.com)

N9075A 802.16  
OFDMA  
(WiMAX/WiBro)  
Measurement  
Application User's &  
Programmer's  
Reference

# Notices

© Keysight Technologies, Inc. 2015

No part of this manual may be reproduced in any form or by any means (including electronic storage and retrieval or translation into a foreign language) without prior agreement and written consent from Keysight Technologies, Inc. as governed by United States and international copyright laws.

## Trademark Acknowledgments

## Manual Part Number

M9420-90012

## Edition

Edition 1, August 2015

## Published by:

### Keysight Technologies

No 116 Tianfu 4th Street  
Chengdu, China 610041

## Warranty

THE MATERIAL CONTAINED IN THIS DOCUMENT IS PROVIDED "AS IS," AND IS SUBJECT TO BEING CHANGED, WITHOUT NOTICE, IN FUTURE EDITIONS. FURTHER, TO THE MAXIMUM EXTENT PERMITTED BY APPLICABLE LAW, KEYSIGHT DISCLAIMS ALL WARRANTIES, EITHER EXPRESS OR IMPLIED WITH REGARD TO THIS MANUAL AND ANY INFORMATION CONTAINED HEREIN, INCLUDING BUT NOT LIMITED TO THE IMPLIED WARRANTIES OF MERCHANTABILITY AND FITNESS FOR A PARTICULAR PURPOSE. KEYSIGHT SHALL NOT BE LIABLE FOR ERRORS OR FOR INCIDENTAL OR CONSEQUENTIAL DAMAGES IN CONNECTION WITH THE FURNISHING, USE, OR PERFORMANCE OF THIS DOCUMENT OR ANY INFORMATION CONTAINED HEREIN. SHOULD KEYSIGHT AND THE USER HAVE A SEPARATE WRITTEN AGREEMENT WITH WARRANTY TERMS COVERING THE MATERIAL IN THIS

DOCUMENT THAT CONFLICT WITH THESE TERMS, THE WARRANTY TERMS IN THE SEPARATE AGREEMENT WILL CONTROL.

## Technology Licenses

The hardware and/or software described in this document are furnished under a license and may be used or copied only in accordance with the terms of such license.

## U.S. Government Rights

The Software is "commercial computer software," as defined by Federal Acquisition Regulation ("FAR") 2.101. Pursuant to FAR 12.212 and 27.405-3 and Department of Defense FAR Supplement ("DFARS") 227.7202, the U.S. government acquires commercial computer software under the same terms by which the software is customarily provided to the public.

Accordingly, Keysight provides the Software to U.S. government customers under its standard commercial license, which is embodied in its End User License Agreement (EULA), a copy of which can be found at

<http://www.keysight.com/find/sweula>

The license set forth in the EULA represents the exclusive authority by which the U.S. government may use, modify, distribute, or disclose the Software. The EULA and the license set forth therein, does not require or permit, among other things, that Keysight: (1) Furnish technical information related to commercial computer software or commercial computer software documentation that is not customarily provided to the public; or (2) Relinquish to, or otherwise provide, the government rights in excess of these rights customarily provided to the public to use, modify, reproduce, release, perform, display, or disclose commercial computer software or commercial computer software documentation. No additional

government requirements beyond those set forth in the EULA shall apply, except to the extent that those terms, rights, or licenses are explicitly required from all providers of commercial computer software pursuant to the FAR and the DFARS and are set forth specifically in writing elsewhere in the EULA. Keysight shall be under no obligation to update, revise or otherwise modify the Software. With respect to any technical data as defined by FAR 2.101, pursuant to FAR 12.211 and 27.404.2 and DFARS 227.7102, the U.S. government acquires no greater than Limited Rights as defined in FAR 27.401 or DFAR 227.7103-5 (c), as applicable in any technical data.

## Safety Notices

### CAUTION

A **CAUTION** notice denotes a hazard. It calls attention to an operating procedure, practice, or the like that, if not correctly performed or adhered to, could result in damage to the product or loss of important data. Do not proceed beyond a CAUTION notice until the indicated conditions are fully understood and met.

### WARNING

A **WARNING** notice denotes a hazard. It calls attention to an operating procedure, practice, or the like that, if not correctly performed or adhered to, could result in personal injury or death. Do not proceed beyond a WARNING notice until the indicated conditions are fully understood and met.

## Table of Contents

N9075A 802.16 OFDMA (WiMAX/WiBro) Measurement Application User's & Programmer's Reference	i
Table of Contents	iii
1 About the Transceiver	45
Installing Application Software	46
Viewing a License Key	46
Obtaining and Installing a License Key	46
Updating Measurement Application Software	46
M9420A Options and Accessories	48
Virtual Front-Panel Features	49
Display Annotations	50
Window Control Keys	51
Virtual Front Panel	51
Windows Control Menu	51
Multi-Window	52
Zoom	52
Next Window	52
Full Screen	53
Display Enable (Remote Command Only)	54
Mouse and Keyboard Control	56
Right-Click	56
PC Keyboard	58
2 About the 802.16 OFDMA Measurement Application	61
3 Programming the Transceiver	63
What Programming Information is Available?	64
STATus Subsystem	65
Detailed Description	67
What Are Status Registers	68
What Are Status Register SCPI Commands	68
How to Use the Status Registers	69
Using a Status Register	70
Using the Service Request (SRQ) Method	71
Generating a Service Request	71
Status Register System	72
The Status Byte Register	73
Standard Event Status Register	75
Operation and Questionable Status Registers	77
Operation Status Register	77
Questionable Status Register	77
STATus Subsystem Command Descriptions	78

Operation Register	78
Operation Condition Query	78
Operation Enable	79
Operation Event Query	79
Operation Negative Transition	79
Operation Positive Transition	80
Preset the Status Byte	80
Questionable Register	81
Questionable Condition	81
Questionable Enable	81
Questionable Event Query	82
Questionable Negative Transition	82
Questionable Positive Transition	82
Questionable Calibration Register	83
Questionable Calibration Condition	83
Questionable Calibration Enable	83
Questionable Calibration Event Query	84
Questionable Calibration Negative Transition	84
Questionable Calibration Positive Transition	85
Questionable Calibration Skipped Register	85
Questionable Calibration Skipped Condition	85
Questionable Calibration Skipped Enable	86
Questionable Calibration Skipped Event Query	86
Questionable Calibration Skipped Negative Transition	87
Questionable Calibration Skipped Positive Transition	87
Questionable Calibration Extended Failure Register	87
Questionable Calibration Extended Failure Condition	88
Questionable Calibration Extended Failure Enable	88
Questionable Calibration Extended Failure Event Query	88
Questionable Calibration Extended Failure Negative Transition	89
Questionable Calibration Extended Failure Positive Transition	89
Questionable Calibration Extended Needed Register	90
Questionable Calibration Extended Needed Condition	90
Questionable Calibration Extended Needed Enable	90
Questionable Calibration Extended Needed Event Query	91
Questionable Calibration Extended Needed Negative Transition	91
Questionable Calibration Extended Needed Positive Transition	92
Questionable Frequency Register	92
Questionable Frequency Condition	92
Questionable Frequency Enable	93
Questionable Frequency Event Query	93
Questionable Frequency Negative Transition	93
Questionable Frequency Positive Transition	94



Questionable Integrity Register	94
Questionable Integrity Condition	94
Questionable Integrity Enable	95
Questionable Integrity Event Query	95
Questionable Integrity Negative Transition	96
Questionable Integrity Positive Transition	96
Questionable Integrity Signal Register	97
Questionable Integrity Signal Condition	97
Questionable Integrity Signal Enable	97
Questionable Integrity Signal Event Query	98
Questionable Integrity Signal Negative Transition	98
Questionable Integrity Signal Positive Transition	98
Questionable Integrity Uncalibrated Register	99
Questionable Integrity Uncalibrated Condition	99
Questionable Integrity Uncalibrated Enable	99
Questionable Integrity Uncalibrated Event Query	100
Questionable Integrity Uncalibrated Negative Transition	100
Questionable Integrity Uncalibrated Positive Transition	101
Questionable Power Register	101
Questionable Power Condition	101
Questionable Power Enable	102
Questionable Power Event Query	102
Questionable Power Negative Transition	103
Questionable Power Positive Transition	103
Questionable Temperature Register	103
Questionable Temperature Condition	104
Questionable Temperature Enable	104
Questionable Temperature Event Query	104
Questionable Temperature Negative Transition	105
Questionable Temperature Positive Transition	105
IEEE 488.2 Common Commands	107
All (Daily use)	107
Clear Status	109
Standard Event Status Enable	110
Standard Event Status Register Query	110
Identification Query	111
Operation Complete	111
Query Instrument Options	112
Recall Instrument State	113
*RST (Remote Command Only)	113
Save Instrument State	114
Service Request Enable	114
Status Byte Query	114

Trigger	115
Self Test Query	115
Wait-to-Continue	115
<b>4 Input/Output Functions</b>	<b>117</b>
Input/Output	118
Input/Output variables - Preset behavior	119
RF Input	120
Input Z Correction	120
RF Input Port	121
RF Input	122
External Gain	122
Ext Preamp	123
More Information	123
MS	124
BTS	125
Restore Input/Output Defaults	126
Freq Ref In	126
External	128
Ext Ref Freq	129
RF Output & Test Set Config	129
RF Output	130
RF Output	130
Output Config	130
Trig Out	131
Polarity	131
Off	131
Sweeping (HSWP)	132
Measuring	132
Main Trigger	132
Gate Trigger	132
Gate	133
Odd/Even Trace Point	133
Trig Out	133
Off	134
Source Marker 1	134
Source Marker 2	134
Source Marker 3	134
Source Marker 4	135
Analog Out	135
More Information	135
Auto	136
Off	136
LISN Control	137

V-network (Remote Command Only)	137
Phase (Remote Command Only)	137
150 kHz Highpass (Remote Command Only)	138
Protective Earth (Remote Command Only)	138
<b>5 Mode Functions</b>	<b>139</b>
Mode	140
More Information	141
IQ Analyzer (Basic)	142
W-CDMA with HSPA+	142
GSM/EDGE/EDGE Evo	143
802.16 OFDMA (WiMAX/WiBro)	143
Vector Signal Analyzer (VXA)	143
Bluetooth	144
TD-SCDMA with HSPA/8PSK	144
cdma2000	144
1xEV-DO	145
WLAN	145
LTE-Advanced FDD	145
LTE-Advanced TDD	146
Application Mode Number Selection (Remote Command Only)	146
Application Mode Catalog Query (Remote Command Only)	147
Application Identification (Remote Commands Only)	147
Current Application Model	148
Current Application Revision	148
Current Application Options	148
Application Identification Catalog (Remote Commands Only)	149
Application Catalog Number of Entries	149
Application Catalog Model Numbers	149
Application Catalog Revision	149
Application Catalog Options	150
Detailed List of Modes	150
1xEV-DO	150
802.16 OFDMA (WiMAX/WiBro)	151
89601 VSA	151
Analog Demod	152
Bluetooth	152
cdma2000	152
GSM/EDGE/EDGE Evo	153
IQ Analyzer (Basic)	153
LTE	153
LTE TDD	154
LTE-Advanced FDD	154
LTE-Advanced TDD	154

Sequence Analyzer	155
TD-SCDMA with HSPA/8PSK	155
Vector Signal Analyzer (VXA)	155
W-CDMA with HSPA+	156
WLAN	156
Global Settings	156
Global Center Freq	157
Restore Defaults	157
Mode Setup	159
Radio Device	159
Radio Standard	159
802.16e–2005 mode	160
FFT Size	160
BW Ratio	161
Guard Interval	161
Frame Duration	162
Downlink Ratio	162
WiBro mode	163
FFT Size	163
BW Ratio	164
Guard Interval	164
Frame Duration	165
Downlink Ratio	165
Preset Profile	166
802.16e–2005 mode	166
WiBro mode	166
Restore Mode Defaults	167
Preset Type (Remote Command Only)	167
Global Settings	167
Global Center Freq	168
Restore Defaults	168
SCPI Only Commands	169
Nominal Bandwidth	169
BW Ratio – Fractional Number	170
Guard Interval – Fractional Number	170
Zone Map Data	171
Key Definition	172
Summary of Key Types	173
<b>6 System Functions</b>	<b>177</b>
File	178
File Explorer	178
Print	179
Maximize/Restore Down	179

Maximize	179
Restore Down	179
Page Setup	179
Print	180
Maximize	181
Minimize	181
Exit	182
Print	183
System	184
Show	184
Errors	184
Previous Page	185
Next Page	186
History	186
Verbose SCPI On/Off	186
Refresh	187
Clear Error Queue	187
Status	187
Input Overload Enable (Remote Command Only)	187
Power Up (Remote Command Only)	188
System	188
Show System contents (Remote Command Only)	189
Computer System description (Remote Command Only)	189
Hardware	190
System Remote Commands (Remote Commands Only)	191
System Powerdown (Remote Command Only)	192
System Log Off (Remote Command Only)	192
List installed Options (Remote Command Only)	192
Lock the Front-panel keys (Remote Command Only)	192
Front Panel activity history (Remote Command only)	193
SCPI activity history (Remote Command only)	193
Instrument start time (Remote Command only)	194
List SCPI Commands (Remote Command Only)	194
SCPI Version Query (Remote Command Only)	195
Date (Remote Command Only)	195
Time (Remote Command Only)	195
Module Name (Remote Command Only)	196
Module Index (Remote Command Only)	196
Module Mnemonic (Remote Command Only)	196
Module List (Remote Command Only)	197
Module Enable (Remote Command Only)	197
Module Default (Remote Command Only)	198
Module Model Number (Remote Command Only)	199

Module Model Serial Number (Remote Command Only)	199
Power On	199
Mode and Input/Output Defaults	200
User Preset	200
Last State	201
Power On Application	201
Configure Applications	202
Preloading Applications	203
Access to Configure Applications utility	203
Virtual memory usage	203
Select All	204
Deselect All	204
Move Up	204
Move Down	204
Select/Deselect	204
Save Changes and Exit	205
Exit Without Saving	205
Restore Power On Defaults	205
Configure Applications - Instrument boot-up	206
Configure Applications - Windows desktop	206
Configure Applications - Remote Commands	206
Configuration list (Remote Command Only)	207
Configuration Memory Available (Remote Command Only)	207
Configuration Memory Total (Remote Command Only)	207
Configuration Memory Used (Remote Command Only)	207
Configuration Application Memory (Remote Command Only)	208
Alignments	208
Align Now	208
All (Daily use)	208
All but RF	211
RF (Weekly use)	212
Source (Weekly use)	214
Show Alignment Statistics	215
Restore Align Defaults	218
Execute Expired Alignments (Remote Command Only)	219
I/O Config	220
SCPI LAN	220
SCPI Telnet	220
SCPI Socket	221
SICL Server	221
HiSLIP Server	222
SCPI Socket Control Port (Remote Command Only)	222
System IDN Response	223

Factory	223
User	224
Lock Remote I/O Session (Remote Command only)	224
Unlock Remote I/O Session (Remote Command only)	227
Remote I/O Session Lock Name (Remote Command only)	227
Remote I/O Session Lock Owner (Remote Command only)	228
Restore Defaults	228
Restore Input/Output Defaults	229
Restore Power On Defaults	229
Restore Align Defaults	230
Restore Misc Defaults	230
Restore Mode Defaults (All Modes)	231
All	232
Control Panel...	233
Licensing...	234
Security	236
USB	236
Read-Write	236
Read only	236
Diagnostics	237
Show Hardware Statistics	237
SCPI for Show Hardware Statistics ( Remote Commands Only)	238
Self test	238
All Self Test	238
FEC Self Test	238
Show Result	239
Internet Explorer...	241
<b>7 Trigger Functions</b>	<b>243</b>
Trigger	244
Trigger Source Presets	245
RF Trigger Source	248
I/Q Trigger Source	249
More Information	250
Free Run	251
Video (IF Envelope)	252
Trigger Level	252
Trig Slope	253
Trig Delay	254
External 1	255
Trigger Level	256
Trig Slope	257
Trig Delay	257
Zero Span Delay Comp On/Off	258

External 2	258
Trigger Level	259
Trig Slope	259
Trig Delay	260
Zero Span Delay Comp On/Off	261
RF Burst	261
Absolute Trigger Level	262
Relative Trigger Level	263
Trigger Slope	264
Trig Delay	264
Periodic Timer (Frame Trigger)	265
Period	267
Offset	267
Reset Offset Display	268
Sync Source	269
Off	269
External 1	270
External 2	271
RF Burst	273
Trig Delay	275
Auto/Holdoff	275
Auto Trig	276
Trig Holdoff	276
Internal	277
<b>8 Channel Power Measurement</b>	<b>279</b>
AMPTD Y Scale	283
Ref Value	283
Range	283
Range	284
Adjust Range For Min Clip	284
Pre-Adjust for Min Clip	284
Peak to Average	285
Mixer Level Offset	285
Scale/Div	286
Ref Position	286
Auto Scaling	287
Auto Couple	288
More Information	288
Auto/Man Active Function keys	288
Auto/Man 1-of-N keys	288
BW	290
Res BW	290
Video BW	291



Filter Type	293
Cont (Continuous Measurement/Sweep)	294
File	296
FREQ Channel	297
Center Freq	297
Center Frequency Presets	298
RF Center Freq	300
Ext Mix Center Freq	301
I/Q Center Freq	302
Input/Output	303
Marker	304
Select Marker	304
Marker Type	304
Properties	305
Select Marker	305
Relative To	305
All Markers Off	306
Marker X Axis Value (Remote Command Only)	306
Marker X Axis Position (Remote Command Only)	306
Marker Y Axis Value (Remote Command only)	307
Backward Compatibility SCPI Commands	307
Marker Function	309
Marker To	310
Meas	311
Remote Measurement Functions	311
Measurement Group of Commands	312
Current Measurement Query (Remote Command Only)	314
Limit Test Current Results (Remote Command Only)	314
Data Query (Remote Command Only)	314
Calculate/Compress Trace Data Query (Remote Command Only)	315
Calculate Peaks of Trace Data (Remote Command Only)	320
Hardware-Accelerated Fast Power Measurement (Remote Command Only)	321
Reset Fast Power Measurement (Remote Command Only)	321
Define Fast Power Measurement (Remote Command Only)	322
Define Fast Power Measurement Query (Remote Command Only)	331
Configure Fast Power Measurement (Remote Command Only)	332
Initiate Fast Power Measurement (Remote Command Only)	333
Fetch Fast Power Measurement (Remote Command Only)	333
Execute Fast Power Measurement (Remote Command Only)	333
Binary Read Fast Power Measurement (Remote Command Only)	334
Diagnostic Binary Read Fast Power Measurement (Remote Command Only)	334
Format Data: Numeric Data (Remote Command Only)	335
Format Data: Byte Order (Remote Command Only)	336

## Table of Contents

Meas Setup	337
Avg/Hold Num	337
Avg Mode	338
Integ BW	339
Method	340
Method	341
Filter Alpha	341
Filter BW	342
Limits	343
Power Limit	343
PSD Limit	344
Power Limit Fail (remote command only)	345
PSD Limit Fail (remote command only)	346
PSD Unit	346
Meas Preset	347
Mode	348
Mode Preset	349
How-To Preset	350
Mode Setup	352
Peak Search	353
Print	354
Quick Save	355
Recall	357
State	357
More Information	359
From File...	359
Edit Register Names	361
Register 1 thru Register 16	361
Register 1 thru Register 16	362
Sequences	363
Source Sequence	363
Open...	364
Data (Import)	364
Mask	365
File location and extension	365
Example of Preset Mask file	366
Zone Map	367
Open...	367
Restart	369
More Information	369
Save	371
State	371
To File . . .	372

Edit Register Names	374
More Information	374
Register 1 thru Register 16	375
Register 1 thru Register 16	375
Mass Storage Catalog (Remote Command Only)	376
Mass Storage Change Directory (Remote Command Only)	377
Mass Storage Copy (Remote Command Only)	377
Mass Storage Device Copy (Remote Command Only)	377
Mass Storage Delete (Remote Command Only)	378
Mass Storage Data (Remote Command Only)	378
Mass Storage Make Directory (Remote Command Only)	378
Mass Storage Move (Remote Command Only)	378
Mass Storage Remove Directory (Remote Command Only)	379
Mass Storage Determine Removable Media (Remote Command Only)	379
Mass Storage Determine Removable Media Label (Remote Command Only)	380
Mass Storage Determine Removable Media Write-protect status (Remote Command Only)	380
Mass Storage Determine Removable Media size (Remote Command Only)	380
Sequences	381
Source Sequence	381
Save As . . .	381
Data (Export)	382
Measurement Results	382
Zone Map	385
Zone Map File Contents	386
Save As . . .	388
Screen Image	388
Themes	389
3D Color	390
3D Monochrome	390
Flat Color	390
Flat Monochrome	391
Save As...	391
Single (Single Measurement/Sweep)	392
More Information	392
Source	393
RF Output	393
Amplitude	393
RF Power	394
RF Power Range	395
RF Power Range	395
Set Reference Power	395
Power Ref	396

Amptd Offset	396
Modulation	397
Frequency	398
Frequency	398
Channel	399
GSM/EDGE Channel Number Ranges	399
W-CDMA Channel Number Ranges	400
CDMA 2000 / 1xEVDO Channel Number Ranges	402
LTE FDD Channel Number Ranges	404
LTE TDD Channel Number Ranges	405
TDSCDMA Channel Number Ranges	406
Radio Setup	407
Radio Standard	407
Radio Band Link	422
Set Reference Frequency	423
Freq Reference	424
Freq Offset	424
Modulation Setup	425
ARB	425
ARB	426
Select Waveform	426
ARB Setup	431
Trigger Type	436
ARB	439
Trigger Initiate	441
Waveform Sequences	441
Waveform Utilities	449
Marker Utilities	454
Header Utilities	459
AM	460
AM	460
AM Depth	461
AM Rate	461
FM	461
FM	462
FM Deviation	462
FM Rate	462
PM	463
PM	463
PM Deviation	463
PM Rate	463
List Sequencer	464
Sequencer	464

Initiate Sequence	465
List Sequencer Setup	465
Number of Steps	465
Current Step	466
Insert Step Before	466
Delete Step	466
Clear List	467
Step Trigger	467
Transition Time	469
Radio Setup	469
Channel	484
Frequency	484
Power	485
Waveform	485
Step Duration	491
Output Trigger	493
Repetition	493
Single	493
Continuous	494
Trigger Type	494
BeginningOfStep	494
DataMarker	495
Manual Trigger Now	496
Source Preset	496
Span X Scale	497
Span	497
Full Span	498
Last Span	499
Sweep/Control	500
Sweep Time	500
Sweep Setup	501
Auto Sweep Time Rules	501
Pause	502
Gate	502
Gate On/Off	502
Gate View On/Off	503
Gate View Setup	506
Gate View Acquisition Time	506
Gate View Start Time	507
Gate Delay	507
Gate Length	508
Gate Source	508
Video (IF Envelope)	509

## Table of Contents

External 1	511
External 2	513
RF Burst	516
Periodic Timer (Frame Trigger)	519
Auto/Holdoff	530
Gate Preset (Remote Command Only)	531
Gate Level (Remote Command Only)	532
Gate Polarity (Remote Command Only)	532
Points	532
System	534
Trace/Detector	535
Trace Type	535
Detector	535
Auto	536
Detector Selection	536
Trigger	538
Free Run	538
Video	538
Trigger Level	538
Trig Slope	538
Trig Delay	538
External 1	538
Trigger Level	538
Trig Slope	538
Trig Delay	538
Zero Span Delay Comp	538
External 2	538
Trigger Level	538
Trig Slope	538
Trig Delay	539
Zero Span Delay Comp	539
RF Burst	539
Absolute Trigger	539
Relative Trigger	539
Trig Slope	539
Trig Delay	539
Periodic Timer	539
Period	539
Offset	539
Reset Offset Display	539
Sync Source	539
Off	539
External 1	539

External 2	540
RF Burst	540
Trig Delay	540
Auto/Holdoff	540
Auto Trig	540
Trig Holdoff	540
Internal	540
User Preset	541
User Preset	541
User Preset All Modes	542
Save User Preset	543
View/Display	544
Display	546
Annotation	547
Meas Bar On/Off	548
Screen	548
Active Function Values On/Off	548
Title	549
Change Title	550
Clear Title	550
Graticule	551
System Display Settings	551
Annotation Local Settings	551
Themes	552
Bar Graph	553
<b>9 ACP Measurement</b>	555
AMPTD Y Scale	567
Ref Value	567
Range	567
Range	568
Adjust Range For Min Clip	568
Pre-Adjust for Min Clip	568
Peak to Average	569
Mixer Level Offset	569
Scale/Div	570
Ref Position	570
Auto Scaling	571
Auto Couple	572
More Information	572
Auto/Man Active Function keys	572
Auto/Man 1-of-N keys	572
BW	574
Res BW	574

Video BW	575
RBW Control	577
Filter Type	577
Filter BW	578
Cont (Continuous Measurement/Sweep)	579
File	581
FREQ Channel	582
Center Freq	582
Center Frequency Presets	583
RF Center Freq	585
Ext Mix Center Freq	586
I/Q Center Freq	587
Input/Output	588
Marker	589
Select Marker	589
Marker Type	589
Properties	590
Select Marker	590
Relative To	590
Marker Trace	591
Couple Markers	592
Marker All Off	592
Marker X Axis Value (Remote Command only)	592
Marker X Axis Position (Remote Command only)	593
Marker Y Axis Value (Remote Command only)	594
Backward Compatibility Remote Commands	594
Marker Function	595
Marker To	596
Meas	597
Remote Measurement Functions	597
Measurement Group of Commands	598
Current Measurement Query (Remote Command Only)	600
Limit Test Current Results (Remote Command Only)	600
Data Query (Remote Command Only)	600
Calculate/Compress Trace Data Query (Remote Command Only)	601
Calculate Peaks of Trace Data (Remote Command Only)	606
Hardware-Accelerated Fast Power Measurement (Remote Command Only)	607
Reset Fast Power Measurement (Remote Command Only)	607
Define Fast Power Measurement (Remote Command Only)	608
Define Fast Power Measurement Query (Remote Command Only)	617
Configure Fast Power Measurement (Remote Command Only)	618
Initiate Fast Power Measurement (Remote Command Only)	619
Fetch Fast Power Measurement (Remote Command Only)	619



Execute Fast Power Measurement (Remote Command Only)	619
Binary Read Fast Power Measurement (Remote Command Only)	620
Diagnostic Binary Read Fast Power Measurement (Remote Command Only)	620
Format Data: Numeric Data (Remote Command Only)	621
Format Data: Byte Order (Remote Command Only)	622
Meas Setup	623
Average/Hold Number	623
Avg Mode	624
Carrier Setup (This menu is unavailable in MSR )	624
Carriers	624
Ref Carrier	625
Ref Car Freq	626
Power Ref	627
Total Power	628
PSD	629
Configure Carriers	630
Carrier	630
Carrier Pwr Present	630
Carrier Spacing	631
Measurement Noise Bandwidth	632
Method for Carrier	634
Carrier Coupling	635
Offset/Limits	636
Select Offset	636
Offset Freq	637
Integ BW	638
Offset BW	640
Res BW	640
Video BW	641
RBW Control	643
Limits	644
Select Offset	645
Abs Limit	645
Rel Lim (Car)	646
Rel Limit (PSD)	649
Fail Mask	650
Offset Side	651
Method for Offset	652
Method for Offset	653
Offset Frequency Define	655
Carrier Result	656
Meas Method	656
Meas Type	658

## Table of Contents

PSD Ref	658
Limit Test	659
Meas Preset	660
Offset RRC Weighting (Backward Compatibility SCPI)	660
Offset Filter Alpha (Backward Compatibility SCPI)	661
Method for Carrier (Backward Compatibility SCPI)	662
Mode	664
Mode Preset	665
How-To Preset	666
Mode Setup	668
Peak Search	669
Next Peak	669
Next Pk Right	669
Next Pk Left	670
Marker Delta	670
Pk-Pk Search	670
Min Search	670
Print	672
Quick Save	673
Recall	675
State	675
More Information	677
From File...	677
Edit Register Names	679
Register 1 thru Register 16	679
Register 1 thru Register 16	680
Sequences	681
Source Sequence	681
Open...	682
Data (Import)	682
Mask	683
File location and extension	683
Example of Preset Mask file	684
Zone Map	685
Open...	685
Restart	687
More Information	687
Save	689
State	689
To File . . .	690
Edit Register Names	692
More Information	692
Register 1 thru Register 16	693

Register 1 thru Register 16	693
Mass Storage Catalog (Remote Command Only)	694
Mass Storage Change Directory (Remote Command Only)	695
Mass Storage Copy (Remote Command Only)	695
Mass Storage Device Copy (Remote Command Only)	695
Mass Storage Delete (Remote Command Only)	696
Mass Storage Data (Remote Command Only)	696
Mass Storage Make Directory (Remote Command Only)	696
Mass Storage Move (Remote Command Only)	696
Mass Storage Remove Directory (Remote Command Only)	697
Mass Storage Determine Removable Media (Remote Command Only)	697
Mass Storage Determine Removable Media Label (Remote Command Only)	698
Mass Storage Determine Removable Media Write-protect status (Remote Command Only)	698
Mass Storage Determine Removable Media size (Remote Command Only)	698
Sequences	699
Source Sequence	699
Save As . . .	699
Data (Export)	700
Measurement Results	700
Zone Map	708
Zone Map File Contents	709
Save As . . .	711
Screen Image	712
Themes	713
3D Color	713
3D Monochrome	713
Flat Color	714
Flat Monochrome	714
Save As...	714
Single (Single Measurement/Sweep)	715
More Information	715
Source	716
RF Output	716
Amplitude	716
RF Power	717
RF Power Range	718
RF Power Range	718
Set Reference Power	718
Power Ref	719
Amptd Offset	719
Modulation	720
Frequency	721

Frequency	721
Channel	722
GSM/EDGE Channel Number Ranges	722
W-CDMA Channel Number Ranges	723
CDMA 2000 / 1xEVDO Channel Number Ranges	725
LTE FDD Channel Number Ranges	727
LTE TDD Channel Number Ranges	728
TDSCDMA Channel Number Ranges	729
Radio Setup	730
Radio Standard	730
Radio Band Link	745
Set Reference Frequency	746
Freq Reference	747
Freq Offset	747
Modulation Setup	748
ARB	748
ARB	749
Select Waveform	749
ARB Setup	754
Trigger Type	759
ARB	762
Trigger Initiate	764
Waveform Sequences	764
Waveform Utilities	772
Marker Utilities	777
Header Utilities	782
AM	783
AM	783
AM Depth	784
AM Rate	784
FM	784
FM	785
FM Deviation	785
FM Rate	785
PM	786
PM	786
PM Deviation	786
PM Rate	786
List Sequencer	787
Sequencer	787
Initiate Sequence	788
List Sequencer Setup	788
Number of Steps	788

Current Step	789
Insert Step Before	789
Delete Step	789
Clear List	790
Step Trigger	790
Transition Time	792
Radio Setup	792
Channel	807
Frequency	807
Power	808
Waveform	808
Step Duration	814
Output Trigger	816
Repetition	816
Single	816
Continuous	817
Trigger Type	817
BeginningOfStep	817
DataMarker	818
Manual Trigger Now	819
Source Preset	819
SPAN X Scale	820
Span	820
Full Span	821
Last Span	821
Sweep/Control	822
Sweep Time	822
Sweep Setup	823
Auto Sweep Time Rules	824
Pause	824
Gate	824
Gate On/Off	825
Gate View On/Off	826
Gate View Setup	828
Gate View Acquisition Time	828
Gate View Start Time	829
Gate Delay	829
Gate Length	830
Gate Source	830
Video (IF Envelope)	831
External 1	833
External 2	835
RF Burst	838

Periodic Timer (Frame Trigger)	841
Auto/Holdoff	852
Gate Preset (Remote Command Only)	853
Gate Level (Remote Command Only)	854
Gate Polarity (Remote Command Only)	854
Points	854
System	856
Trace/Detector	857
Select Trace (Front-panel Only)	857
Trace Type	857
View/Blank	858
Detector	859
Auto	860
Detector Selection	860
Trigger	862
Free Run	862
Video	862
Trigger Level	862
Trig Slope	862
Trig Delay	862
External 1	862
Trigger Level	862
Trig Slope	862
Trig Delay	862
Zero Span Delay Comp	862
External 2	862
Trigger Level	862
Trig Slope	862
Trig Delay	863
Zero Span Delay Comp	863
RF Burst	863
Absolute Trigger	863
Relative Trigger	863
Trig Slope	863
Trig Delay	863
Periodic Timer	863
Period	863
Offset	863
Reset Offset Display	863
Sync Source	863
Off	863
External 1	863
External 2	864

RF Burst	864
Trig Delay	864
Auto/Holdoff	864
Auto Trig	864
Trig Holdoff	864
Internal	864
User Preset	865
User Preset	865
User Preset All Modes	866
Save User Preset	867
View/Display	868
Spectrum Window	870
Results Window	870
Display	872
Annotation	872
Meas Bar On/Off	873
Screen	874
Active Function Values On/Off	874
Title	875
Change Title	875
Clear Title	876
Graticule	877
System Display Settings	877
Annotation Local Settings	877
Themes	878
Bar Graph	879
<b>10 Spectrum Emission Mask Measurement</b>	<b>881</b>
AMPTD Y Scale	904
Ref Value	904
Range	904
Range	905
Adjust Range For Min Clip	905
Pre-Adjust for Min Clip	905
Peak to Average	906
Mixer Level Offset	906
Scale/Div	907
Ref Position	907
Auto Scaling	908
Auto Couple	909
More Information	909
Auto/Man Active Function keys	909
Auto/Man 1-of-N keys	909
BW	911

Filter Type	911
Cont (Continuous Measurement/Sweep)	912
File	914
FREQ Channel	915
Center Freq	915
Center Frequency Presets	916
RF Center Freq	918
Ext Mix Center Freq	919
I/Q Center Freq	920
Input/Output	921
Marker	922
Select Marker	922
Marker Type	922
Couple Markers	923
All Markers Off	923
Marker X Axis Value (Remote Command Only)	923
Marker X Axis Position (Remote Command Only)	924
Marker Y Axis Value (Remote Command Only)	925
Marker Function	926
Marker To	927
Meas	928
Remote Measurement Functions	928
Measurement Group of Commands	929
Current Measurement Query (Remote Command Only)	931
Limit Test Current Results (Remote Command Only)	931
Data Query (Remote Command Only)	931
Calculate/Compress Trace Data Query (Remote Command Only)	932
Calculate Peaks of Trace Data (Remote Command Only)	937
Hardware-Accelerated Fast Power Measurement (Remote Command Only)	938
Reset Fast Power Measurement (Remote Command Only)	938
Define Fast Power Measurement (Remote Command Only)	939
Define Fast Power Measurement Query (Remote Command Only)	948
Configure Fast Power Measurement (Remote Command Only)	949
Initiate Fast Power Measurement (Remote Command Only)	950
Fetch Fast Power Measurement (Remote Command Only)	950
Execute Fast Power Measurement (Remote Command Only)	950
Binary Read Fast Power Measurement (Remote Command Only)	951
Diagnostic Binary Read Fast Power Measurement (Remote Command Only)	951
Format Data: Numeric Data (Remote Command Only)	952
Format Data: Byte Order (Remote Command Only)	953
Meas Setup	954
Avg/Hold Num	954
Meas Type	954



Ref Channel	955
Integ BW	955
Span	956
Sweep Time	958
Power Ref (for the modes except MSR and LTE-Advanced FDD/TDD)	958
Total Power	959
PSD	959
Spectrum Peak	960
Res BW	961
Video BW	962
VBW/RBW	964
Offset/Limits	965
Select Offset	965
Start Freq	965
Stop Freq	968
Sweep Time	970
Offset Side	971
Res BW	972
Meas BW	974
Video BW	975
VBW/RBW	976
Limits	978
Select Offset	978
Abs Start	978
Abs Stop	980
Rel Start	983
Rel Stop	985
Fail Mask	987
Offset Freq Define	989
Method	991
Filter Alpha	992
Meas Preset	992
Mode	994
Mode Preset	995
How-To Preset	996
Mode Setup	998
Peak Search	999
Print	1000
Quick Save	1001
Recall	1003
State	1003
More Information	1005
From File...	1005

## Table of Contents

Edit Register Names	1007
Register 1 thru Register 16	1007
Register 1 thru Register 16	1008
Sequences	1009
Source Sequence	1009
Open...	1010
Data (Import)	1010
Mask	1011
File location and extension	1011
Example of Preset Mask file	1012
Zone Map	1013
Open...	1013
Restart	1015
More Information	1015
Save	1017
State	1017
To File . . .	1018
Edit Register Names	1020
More Information	1020
Register 1 thru Register 16	1021
Register 1 thru Register 16	1021
Mass Storage Catalog (Remote Command Only)	1022
Mass Storage Change Directory (Remote Command Only)	1023
Mass Storage Copy (Remote Command Only)	1023
Mass Storage Device Copy (Remote Command Only)	1023
Mass Storage Delete (Remote Command Only)	1024
Mass Storage Data (Remote Command Only)	1024
Mass Storage Make Directory (Remote Command Only)	1024
Mass Storage Move (Remote Command Only)	1024
Mass Storage Remove Directory (Remote Command Only)	1025
Mass Storage Determine Removable Media (Remote Command Only)	1025
Mass Storage Determine Removable Media Label (Remote Command Only)	1026
Mass Storage Determine Removable Media Write-protect status (Remote Command Only)	1026
Mass Storage Determine Removable Media size (Remote Command Only)	1026
Sequences	1027
Source Sequence	1027
Save As . . .	1027
Data (Export)	1028
Measurement Results	1028
Meas Results File Contents	1029
Zone Map	1038
Zone Map File Contents	1039

Save As . . .	1041
Screen Image	1041
Themes	1042
3D Color	1043
3D Monochrome	1043
Flat Color	1043
Flat Monochrome	1044
Save As...	1044
Single (Single Measurement/Sweep)	1045
More Information	1045
Source	1046
RF Output	1046
Amplitude	1046
RF Power	1047
RF Power Range	1048
RF Power Range	1048
Set Reference Power	1048
Power Ref	1049
Amptd Offset	1049
Modulation	1050
Frequency	1051
Frequency	1051
Channel	1052
GSM/EDGE Channel Number Ranges	1052
W-CDMA Channel Number Ranges	1053
CDMA 2000 / 1xEVDO Channel Number Ranges	1055
LTE FDD Channel Number Ranges	1057
LTE TDD Channel Number Ranges	1058
TDSCDMA Channel Number Ranges	1059
Radio Setup	1060
Radio Standard	1060
Radio Band Link	1075
Set Reference Frequency	1076
Freq Reference	1077
Freq Offset	1077
Modulation Setup	1078
ARB	1078
ARB	1079
Select Waveform	1079
ARB Setup	1084
Trigger Type	1089
ARB	1092
Trigger Initiate	1094

Waveform Sequences	1094
Waveform Utilities	1102
Marker Utilities	1107
Header Utilities	1112
AM	1113
AM	1113
AM Depth	1114
AM Rate	1114
FM	1114
FM	1115
FM Deviation	1115
FM Rate	1115
PM	1116
PM	1116
PM Deviation	1116
PM Rate	1116
List Sequencer	1117
Sequencer	1117
Initiate Sequence	1118
List Sequencer Setup	1118
Number of Steps	1118
Current Step	1119
Insert Step Before	1119
Delete Step	1119
Clear List	1120
Step Trigger	1120
Transition Time	1122
Radio Setup	1122
Channel	1137
Frequency	1137
Power	1138
Waveform	1138
Step Duration	1144
Output Trigger	1146
Repetition	1146
Single	1146
Continuous	1147
Trigger Type	1147
BeginningOfStep	1147
DataMarker	1148
Manual Trigger Now	1149
Source Preset	1149
Span X Scale	1150

Ref Value	1150
Scale/Div	1150
Ref Position	1151
Auto Scaling	1151
Sweep/Control	1153
Pause	1153
Gate	1153
Gate On/Off	1153
Gate View On/Off	1154
Gate View Setup	1157
Gate View Acquisition Time	1157
Gate View Start Time	1158
Gate Delay	1158
Gate Length	1159
Gate Source	1159
Video (IF Envelope)	1160
External 1	1162
External 2	1164
RF Burst	1167
Periodic Timer (Frame Trigger)	1170
Auto/Holdoff	1181
Gate Preset (Remote Command Only)	1182
Gate Level (Remote Command Only)	1183
Gate Polarity (Remote Command Only)	1183
System	1184
Trace/Detector	1185
Trace Type	1185
Chan Detector	1185
Chan Detector Auto	1186
Chan Detector Selection	1186
Offset Detector	1187
Offset Detector Auto	1187
Offset Detector Selection	1188
Trigger	1189
Free Run	1189
Video	1189
Trigger Level	1189
Trig Slope	1189
Trig Delay	1189
External 1	1189
Trigger Level	1189
Trig Slope	1189
Trig Delay	1189

## Table of Contents

Zero Span Delay Comp	1189
External 2	1189
Trigger Level	1189
Trig Slope	1189
Trig Delay	1190
Zero Span Delay Comp	1190
RF Burst	1190
Absolute Trigger	1190
Relative Trigger	1190
Trig Slope	1190
Trig Delay	1190
Periodic Timer	1190
Period	1190
Offset	1190
Reset Offset Display	1190
Sync Source	1190
Off	1190
External 1	1190
External 2	1191
RF Burst	1191
Trig Delay	1191
Auto/Holdoff	1191
Auto Trig	1191
Trig Holdoff	1191
Internal	1191
User Preset	1192
User Preset	1192
User Preset All Modes	1193
Save User Preset	1194
View/Display	1195
View Selection by Name (Remote Command Only)	1195
Views Selection by Number (Remote Command only)	1196
Display	1196
Annotation	1197
Meas Bar On/Off	1198
Screen	1199
Active Function Values On/Off	1199
Title	1200
Change Title	1200
Clear Title	1201
Graticule	1202
System Display Settings	1202
Annotation Local Settings	1202

Themes	1203
Abs Pwr Freq	1204
Abs Peak Pwr & Freq (Total Pwr Ref)	1204
Trace Window	1206
Results Window	1206
Abs Peak Pwr & Freq (PSD Ref)	1206
Trace Window	1208
Results Window	1208
Abs Peak Pwr & Freq (Spectrum Pk Ref)	1208
Trace Window	1210
Results Window	1210
Rel Pwr Freq	1210
Rel Peak Pwr & Freq (Total Pwr Ref)	1210
Trace Window	1211
Results Window	1211
Rel Peak Pwr & Freq (PSD Ref)	1212
Trace Window	1212
Results Window	1213
Rel Peak Pwr & Freq (Spectrum Pk Ref)	1213
Trace Window	1214
Results Window	1214
Integrated Power	1215
Integrated Power (Total Pwr Ref)	1215
Trace Window	1217
Results Window	1217
Integrated Power (PSD Ref)	1218
Trace Window	1220
Results Window	1220
Integrated Power (Spectrum Pk Ref)	1221
Trace Window	1222
Results Window	1222
Limit Lines	1223
<b>11 Modulation Analysis Measurement</b>	<b>1225</b>
AMPTD Y Scale	1243
Range	1243
Range	1243
Adjust Range For Min Clip	1243
Pre-Adjust for Min Clip	1244
Peak to Average	1244
Mixer Level Offset	1245
Auto Couple	1246
More Information	1246
Auto/Man Active Function keys	1246

Auto/Man 1-of-N keys	1246
BW	1248
Info BW	1248
Cont (Continuous Measurement/Sweep)	1249
File	1251
FREQ Channel	1252
Center Freq	1252
Center Frequency Presets	1253
RF Center Freq	1255
Ext Mix Center Freq	1256
I/Q Center Freq	1257
Input/Output	1258
Marker	1259
Select Marker	1259
Marker Type	1259
Properties	1260
Select Marker	1260
Relative To	1260
Marker Trace	1260
All Markers Off	1261
Marker X Axis Value (Remote Command only)	1261
Marker X Axis Position (Remote Command only)	1262
Marker X Axis Subcarrier (Remote Command only)	1262
Marker X Axis Symbol (Remote Command only)	1263
Marker Y Axis Value (Remote Command only)	1264
Backward Compatibility SCPI Commands	1264
Marker Function	1266
Marker To	1267
Meas	1268
Remote Measurement Functions	1268
Measurement Group of Commands	1269
Current Measurement Query (Remote Command Only)	1271
Limit Test Current Results (Remote Command Only)	1271
Data Query (Remote Command Only)	1271
Calculate/Compress Trace Data Query (Remote Command Only)	1272
Calculate Peaks of Trace Data (Remote Command Only)	1277
Hardware-Accelerated Fast Power Measurement (Remote Command Only)	1278
Reset Fast Power Measurement (Remote Command Only)	1278
Define Fast Power Measurement (Remote Command Only)	1279
Define Fast Power Measurement Query (Remote Command Only)	1288
Configure Fast Power Measurement (Remote Command Only)	1289
Initiate Fast Power Measurement (Remote Command Only)	1290
Fetch Fast Power Measurement (Remote Command Only)	1290



Execute Fast Power Measurement (Remote Command Only)	1290
Binary Read Fast Power Measurement (Remote Command Only)	1291
Diagnostic Binary Read Fast Power Measurement (Remote Command Only)	1291
Format Data: Numeric Data (Remote Command Only)	1292
Format Data: Byte Order (Remote Command Only)	1293
Meas Setup	1294
Avg/Hold Num	1294
Avg Mode	1294
Limits	1295
RMS RCE	1295
Limits	1295
Composite	1296
QPSK-1/2	1296
QPSK-3/4	1297
16QAM-1/2	1297
16QAM-3/4	1298
64QAM-1/2	1298
64QAM-2/3	1299
64QAM-3/4	1299
Peak RCE	1299
Pilot RCE	1300
Frequency Error	1301
Time Offset	1301
I/Q Offset	1302
Abs Spectral Flatness	1302
Offset	1302
Start Subcarrier	1303
Stop Subcarrier	1304
Offset Side	1305
Upper Mask Start	1306
Upper Mask Stop	1307
Lower Mask Start	1308
Lower Mask Stop	1308
Zone/Data Burst Map	1309
Auto Detect Now	1310
Zone Num	1310
Data Burst Analysis	1310
Burst Map	1311
Use Defined Boosting Level	1311
Single Burst	1311
Subchan Offset	1311
Burst Region Subchannel Interval	1312
Symbol Offset	1312

## Table of Contents

Symbol Interval	1313
Burst Shape	1313
Data Mod Type	1313
Uniform Zone	1314
Data Mod Type	1314
Zone Offset	1314
Zone Interval	1315
Data Burst Select	1315
Data Burst Num	1316
All On	1316
Single	1316
Preamble Index	1316
Subchannel Group Bitmask	1317
Meas Preset	1317
Advanced	1318
Pilot in RMS/Pk RCE	1318
Spectrum	1318
Symbol Timing Adjust	1319
Pilot Tracking	1320
Track Amplitude	1320
Track Phase	1321
Track Timing	1321
Equalizer Training	1322
Equalizer Smoothing	1322
I/Q Mismatch Compensation	1322
Multi Carrier Filter	1323
Mode	1324
Mode Preset	1325
How-To Preset	1326
Mode Setup	1328
Peak Search	1329
Next Peak	1329
Next Pk Right	1329
Next Pk Left	1329
Marker Delta	1330
Pk-Pk Search	1330
Min Search	1330
Print	1331
Quick Save	1332
Recall	1334
State	1334
More Information	1336
From File...	1336

Edit Register Names	1338
Register 1 thru Register 16	1338
Register 1 thru Register 16	1339
Sequences	1340
Source Sequence	1340
Open...	1341
Data (Import)	1341
Mask	1342
File location and extension	1342
Example of Preset Mask file	1343
Zone Map	1344
Open...	1344
Restart	1346
More Information	1346
Save	1348
State	1348
To File . . .	1349
Edit Register Names	1351
More Information	1351
Register 1 thru Register 16	1352
Register 1 thru Register 16	1352
Mass Storage Catalog (Remote Command Only)	1353
Mass Storage Change Directory (Remote Command Only)	1354
Mass Storage Copy (Remote Command Only)	1354
Mass Storage Device Copy (Remote Command Only)	1354
Mass Storage Delete (Remote Command Only)	1355
Mass Storage Data (Remote Command Only)	1355
Mass Storage Make Directory (Remote Command Only)	1355
Mass Storage Move (Remote Command Only)	1355
Mass Storage Remove Directory (Remote Command Only)	1356
Mass Storage Determine Removable Media (Remote Command Only)	1356
Mass Storage Determine Removable Media Label (Remote Command Only)	1357
Mass Storage Determine Removable Media Write-protect status (Remote Command Only)	1357
Mass Storage Determine Removable Media size (Remote Command Only)	1357
Sequences	1358
Source Sequence	1358
Save As . . .	1358
Data (Export)	1359
Measurement Results	1359
Meas Results File Contents	1360
Marker Table	1360
Peak Table	1363

Spectrogram	1366
Zone Map	1370
Zone Map File Contents	1371
Save As . . .	1373
Screen Image	1374
Themes	1375
3D Color	1375
3D Monochrome	1375
Flat Color	1376
Flat Monochrome	1376
Save As...	1376
Single (Single Measurement/Sweep)	1377
More Information	1377
Source	1378
RF Output	1378
Amplitude	1378
RF Power	1379
RF Power Range	1380
RF Power Range	1380
Set Reference Power	1380
Power Ref	1381
Amptd Offset	1381
Modulation	1382
Frequency	1383
Frequency	1383
Channel	1384
GSM/EDGE Channel Number Ranges	1384
W-CDMA Channel Number Ranges	1385
CDMA 2000 / 1xEVDO Channel Number Ranges	1387
LTE FDD Channel Number Ranges	1389
LTE TDD Channel Number Ranges	1390
TDSCDMA Channel Number Ranges	1391
Radio Setup	1392
Radio Standard	1392
Radio Band Link	1407
Set Reference Frequency	1408
Freq Reference	1409
Freq Offset	1409
Modulation Setup	1410
ARB	1410
ARB	1411
Select Waveform	1411
ARB Setup	1416

Trigger Type	1421
ARB	1424
Trigger Initiate	1426
Waveform Sequences	1426
Waveform Utilities	1434
Marker Utilities	1439
Header Utilities	1444
AM	1445
AM	1445
AM Depth	1446
AM Rate	1446
FM	1446
FM	1447
FM Deviation	1447
FM Rate	1447
PM	1448
PM	1448
PM Deviation	1448
PM Rate	1448
List Sequencer	1449
Sequencer	1449
Initiate Sequence	1450
List Sequencer Setup	1450
Number of Steps	1450
Current Step	1451
Insert Step Before	1451
Delete Step	1451
Clear List	1452
Step Trigger	1452
Transition Time	1454
Radio Setup	1454
Channel	1469
Frequency	1469
Power	1470
Waveform	1470
Step Duration	1476
Output Trigger	1478
Repetition	1478
Single	1478
Continuous	1479
Trigger Type	1479
BeginningOfStep	1479
DataMarker	1480

Manual Trigger Now	1481
Source Preset	1481
SPAN X Scale	1482
Ref Value	1482
Ref Value (Error vs. Subcarrier Window)	1482
Ref Value (Symbol Power vs. Subcarrier Window)	1483
Ref Value (Absolute Flatness Window/Differential Flatness Window)	1483
Ref Value (Power vs Time Window)	1484
Ref Value (Symbol Error vs. Symbol Window)	1484
Ref Value (Symbol Power vs. Symbol Window)	1485
Scale/Div	1485
Scale/Div (Symbol Error vs. Subcarrier Window)	1485
Scale/Div (Symbol Power vs. Subcarrier Window)	1486
Scale/Div (Absolute Flatness/Differential Flatness Window)	1486
Scale/Div (Power vs Time Window)	1487
Scale/Div (Symbol Error vs. Symbol Window)	1487
Scale/Div (Symbol Power vs. Symbol Window)	1488
Ref Position	1488
Ref Position (Symbol Error vs. Subcarrier Window)	1489
Ref Position (Symbol Power vs. Subcarrier Window)	1489
Ref Position (Absolute Flatness/Differential Flatness Window)	1489
Ref Position (Power vs Time Window)	1490
Ref Position (Symbol Error vs Symbol Window)	1490
Ref Position (Symbol Power vs Symbol Window)	1491
Auto Scaling	1491
AutoScaling (Symbol Error vs. Subcarrier Window)	1491
AutoScaling (Symbol Power vs. Subcarrier Window)	1492
AutoScaling (Absolute Flatness/Differential Flatness Window)	1492
AutoScaling (Power vs Time Window)	1493
AutoScaling (Symbol Error vs Symbol Window)	1493
AutoScaling (Symbol Power vs Symbol Window)	1494
Sweep/Control	1495
Pause/Resume	1495
System	1496
Trace/Detector	1497
Trigger	1498
Free Run	1498
Video	1498
Trigger Level	1498
Trig Slope	1498
Trig Delay	1498
External 1	1498
Trigger Level	1498

Trig Slope	1498
Trig Delay	1498
Zero Span Delay Comp	1498
External 2	1498
Trigger Level	1498
Trig Slope	1498
Trig Delay	1499
Zero Span Delay Comp	1499
RF Burst	1499
Absolute Trigger	1499
Relative Trigger	1499
Trig Slope	1499
Trig Delay	1499
Periodic Timer	1499
Period	1499
Offset	1499
Offset Adjust (Remote Command Only)	1499
Reset Offset Display	1499
Sync Source	1499
Off	1499
External 1	1500
External 2	1500
RF Burst	1500
Trig Delay	1500
Auto/Holdoff	1500
Auto Trig	1500
Trig Holdoff	1500
Internal	1500
User Preset	1501
User Preset	1501
User Preset All Modes	1502
Save User Preset	1503
View/Display	1504
Understanding Front Panel Results to Use Remote Commands	1504
Front Panel Results	1504
View Selection by name (SCPI Only)	1505
View Selection by number (SCPI Only)	1505
Display	1506
Annotation	1506
Meas Bar On/Off	1507
Screen	1508
Active Function Values On/Off	1508
Title	1509

Change Title	1509
Clear Title	1510
Graticule	1511
System Display Settings	1511
Annotation Local Settings	1511
Themes	1512
IQ Symbol Measured Constin	1513
I/Q Symbol Constellation Window	1514
Numeric Results Window	1514
Inactive Subchannels	1515
Zone Data Burst Info	1515
Zone List Window	1516
Zone Definition Window	1516
Data Burst List Window	1517
Symbol Error (Quad View)	1517
Symbol Error vs Subcarrier Window	1518
Symbol Error vs Symbol Window	1518
I/Q Symbol Constellation Window	1518
Zone Definition Window	1519
Inactive Subchannels	1519
Symbol Power (Quad View)	1520
Symbol Power Vector vs Subcarrier Window	1520
Symbol Power Vector vs Symbol	1521
I/Q Symbol Constellation	1521
Zone Definition	1521
Inactive Subchannels	1521
Peak/Avg Metrics	1522
Zoomed Result Metrics	1524
Power vs. Time and Spectrum	1531
Power vs Time Window	1531
Power vs Spectrum Window	1531
OBW Line	1532



## 1 About the Transceiver

The M9420A VXT Vector Transceiver measures and monitors complex RF and microwave signals. The transceiver integrates traditional measurements with advanced vector signal analysis to optimize speed, accuracy, and dynamic range.

With a broad set of applications and demodulation capabilities, an intuitive virtual user interface, outstanding connectivity and powerful measurements, the transceiver is ideal for both R&D and manufacturing engineers working on cellular, emerging wireless communications, general purpose, aerospace and defense applications.

## Installing Application Software

If you want to install a measurement application after your initial hardware purchase, you need only to license it. When you purchase a new application, you will receive an entitlement certificate that you can use to obtain a license key for that application. To activate the new measurement application, enter the license key that you obtain into the Signal Transceiver.

### Viewing a License Key

Measurement applications that you purchased with your instrument have been installed and activated at the factory before shipment. The instrument requires a unique License Key for every measurement application purchased. The license key is a hexadecimal string that is specific to your measurement application, instrument model number and serial number. It enables you to install, or reactivate, that particular application.

Press **System, Show, System** in virtual panel to display the measurement applications that are currently licensed in your transceiver.

Go to the following location to view the license keys for the installed measurement applications:

C:\Program Files\Keysight\Licensing

You may want to keep a copy of your license key in a secure location. To do this, you can print out a copy of the display showing the license numbers. If you should lose your license key, call your nearest Keysight Technologies service or sales office for assistance.

### Obtaining and Installing a License Key

If you purchase an additional application that requires installation, you will receive an "Entitlement Certificate", which may be redeemed for a license key for one instrument. To obtain your license key, follow the instructions that accompany the certificate.

Installing a license key for the selected application can be done automatically using a USB memory device. To do this, you copy the license file to the USB memory device, at the root level. Follow the instructions that come with your software installation kit.

Installing a license key can also be done manually using the built-in license management application, which may be found via the virtual front panel keys at **System, Licensing. . .**, or on-disk at:

C:\Programming Files\Keysight\Licensing

You can also use these procedures to reinstall a license key that has been accidentally deleted, or lost due to a memory failure.

### Updating Measurement Application Software

All the software applications were loaded at the time of original instrument manufacture. It is a good idea to regularly update your software with the latest available version. This helps to ensure that you receive any improvements and expanded functionality.

Because the software was loaded at the initial purchase, further additional measurement applications may now be available. If the application you are interested in licensing is not available, you will need to do a software update. (To display a list of installed applications, press **System, Show, System** in virtual panel.)

Check the appropriate page of the Keysight web site for the latest available software versions as follows:

<http://www.keysight.com/find/m9420a>

You can load the updated software package into the analyzer from a USB drive, or directly from Internet. An automatic loading program is included with the files.

## M9420A Options and Accessories

You can view an online list of available Options and Accessories for your instrument as follows:

1. Browse to one of the following URLs, according to the product name of your analyzer:  
[www.keysight.com/find/m9420a](http://www.keysight.com/find/m9420a)
2. The home page for Keysight M9420A VXT Vector Transceiver appears (in some cases, you may see an initial splash screen containing a button named View the Webpage, which you should click to display the home page).
3. Click the Options tab, to display a list of available options and accessories for your instrument.

## Virtual Front-Panel Features

The instrument's Virtual Front-panel features are fully detailed in the section "Virtual Front-Panel Features" of the M9420A Getting Started Guide.

## Display Annotations

Display Annotations are fully detailed under the Section "Display Annotations" of the M9420A Getting Started Guide.

## Window Control Keys

The instrument provides three virtual-front-panel keys or four menu items for controlling windows.

### Virtual Front Panel

The virtual-front-panel keys are Multi Window, Zoom, and Next Window. These are all “immediate action” keys.



### Windows Control Menu

The menu items are Zoom, Split Screen, Next [Window], and Full screen. These are all “immediate action” menu selections. Zoom and Full Screen are toggle functions.

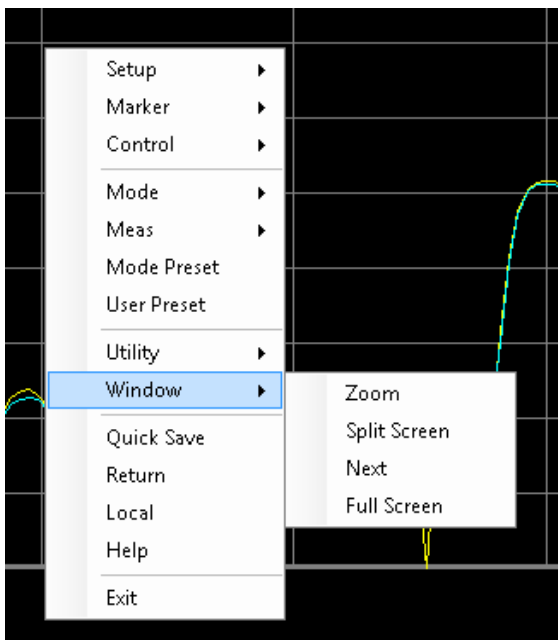

## Multi-Window

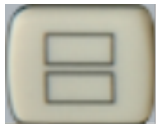

The Multi Window front-panel key will toggle you back and forth between the Normal View and the last Multi Window View (Zone Span, Trace Zoom or Spectrogram) that you were in, when using the Swept SA measurement of the Spectrum Analyzer Mode. It remembers which View you were in through a Preset. This “previous view” is set to Zone Span on a Restore Mode Defaults.

---

Key Path	Front-panel key
Initial S/W Revision	Prior to A.02.00

---

## Zoom

Zoom is a toggle function. Pressing this key once increases the size of the selected window. Pressing the key again returns the window to the original size.

When Zoom is on for a window, that window will get the entire primary display area. The zoomed window, since it is the selected window, is outlined in green.

Zoom is local to each Measurement. Each Measurement remembers its Zoom state. The Zoom state of each Measurement is part of the Mode’s state.

**NOTE**

Data acquisition and processing for the other windows continues while a window is zoomed, as does all SCPI communication with the other windows.

---

Remote Command	:DISPlay:WINDow:FORMat:ZOOM
Remote Command	:DISPlay:WINDow:FORMat:TILE
Example	:DISP:WIND:FORM:ZOOM sets zoomed :DISP:WIND:FORM:TILE sets un-zoomed
Preset	TILE
Initial S/W Revision	Prior to A.02.00

---

## Next Window

Selects the next window of the current view. When the Next Window key is pressed, the next window in the order of precedence becomes selected. If the selected window was zoomed, the next window will also be zoomed.

The window numbers are as follows. Note that these numbers also determine the order of precedence (that is, Next Window goes from 1 to 2, then 2 to 3, etc.):





**Four window display**

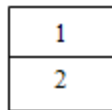

**Two window display**

### RTSA measurements:

Only two windows are available in the Spectrogram view under the Spectrum measurement and up to three windows are available in the Power vs. Time measurement, depending on the view set up.

<b>Remote Command</b>	:DISPlay:WINDow[:SElect] <number> :DISPlay:WINDow[:SElect]?
<b>Example</b>	:DISP:WIND 1
<b>Preset</b>	1
<b>Min</b>	1
<b>Max</b>	If <number> is greater than the number of windows, limit to <number of windows>
<b>Initial S/W Revision</b>	Prior to A.02.00

One and only one window is always selected. The selected window has the focus; this means that all window-specific key presses apply only to that window. You can tell which window is selected by the thick green border around it. If a window is not selected, its boundary is gray.

If a window in a multi-window display is zoomed it is still outlined in green. If there is only one window, the green outline is not used. This allows the user to distinguish between a zoomed window and a display with only one window.

The selected window is local to each Measurement. Each Measurement remembers which window is selected. The selected window for each Measurement is remembered in Mode state.

**NOTE**

When this key is pressed in Help Mode, it toggles focus between the table of contents window and the topic pane window.

### Full Screen

When Full Screen is pressed the measurement window expands horizontally over the entire instrument display. The screen graticule area expands to fill the available display area.

It turns off the display of the softkey labels, however the menus and active functions still work. (Though it would obviously be very hard to navigate without the key labels displayed.) Pressing Full Screen again while Full Screen is in effect cancels Full Screen.

Note that the banner and status lines are unaffected. You can get even more screen area for your data display by turning off the Meas Bar (in the Display menu) which also turns off the settings panel.

Full Screen is a Meas Global function. Therefore it is cancelled by the Preset key.

Key Path	Display
<b>Remote Command</b>	:DISPlay:FSCReen[:STATe] OFF ON 0 1 :DISPlay:FSCReen[:STATe]?
Preset	Unaffected by Preset but set to Off by Restore Misc Defaults or shutdown and restart
State Saved	Not saved in instrument state.
<b>Backwards Compatibility SCPI</b>	:DISPlay:MENU[:STATe] OFF ON 0 1 This emulates ESA full screen functionality, which is the same as the FSCReen command in PSA except that the sense of on/off is reversed (that is, OFF means the menus are OFF, so Fullscreen is ON) and the default is ON (meaning Fullscreen is OFF).
Backwards Compatibility Notes	In ESA/PSA, Full Screen was turned on with a softkey, so pressing any other key turned Full Screen off. In the X-Series, because a hardkey is provided to turn this function on and off, pressing any other key no longer turns off Full Screen
Initial S/W Revision	Prior to A.02.00

### Display Enable (Remote Command Only)

Turns the display on/off, including the display drive circuitry. The backlight stays lit so you can tell that the instrument is on. The display enable setting is mode global. The reasons for turning the display off are three:

- To increase speed as much as possible by freeing the instrument from having to update the display
- To reduce emissions from the display, drive circuitry
- For security purposes

If you have turned off the display:

- and you are in local operation, the display can be turned back on by pressing any key or by sending the SYSTem:DEFaults MISC command or the DISPlay:ENABle ON (neither \*RST nor SYSTem:PRESet enable the display.)
- and you are in remote operation, the display can be turned back on by pressing the Local or Esc keys or by sending the SYSTem:DEFaults MISC command or the DISPlay:ENABle ON (neither \*RST nor SYSTem:PRESet enable the display.)

and you are using either the SYSTem:KLOCK command or GPIB local lockout, then no front-panel key press will turn the display back on. You must turn it back on remotely.

<b>Remote Command</b>	:DISPlay:ENABle OFF ON 0 1 :DISPlay:ENABle?
<b>Example</b>	DISP:ENAB OFF
Couplings	DISP:ENAB OFF turns Backlight OFF and DISP:ENAB ON turns Backlight ON. However, settings of Backlight do not change the state of DISP:ENAB
Preset	On Set by SYST:DEF MISC, but Not affected by *RST or SYSTem:PRESet.

---

State Saved	Not saved in instrument state.
Backwards Compatibility Notes	SYST:PRES no longer turns on DISPlay:ENABle as it did in legacy analyzers
Initial S/W Revision	Prior to A.02.00

---

## Mouse and Keyboard Control

If you do not have access to the instrument front-panel, there are several ways that a mouse and PC Keyboard can give you access to functions normally accessed using the front-panel keys.

For instrument lacking a physical front panel display, you can watch the instrument display via external monitor or remote desktop connection

### Right-Click

If you plug in a mouse and right-click on the analyzer screen, a menu will appear as below:

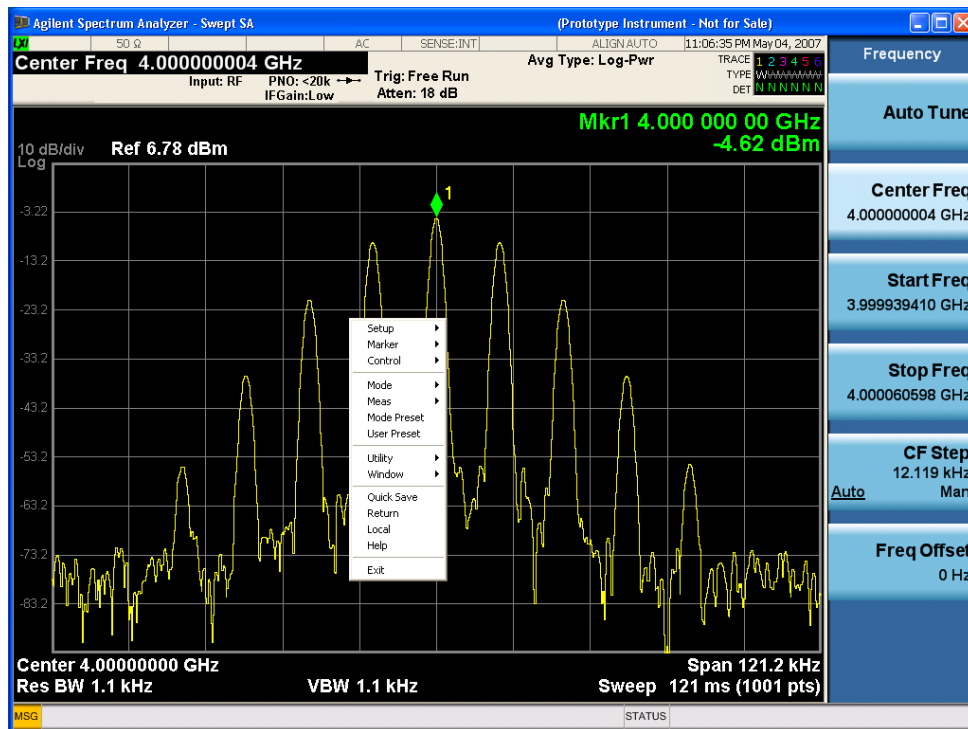

Placing the mouse on one of the rows marked with a right arrow symbol will cause that row to expand, as for example below where the mouse is hovered over the “Utility” row:

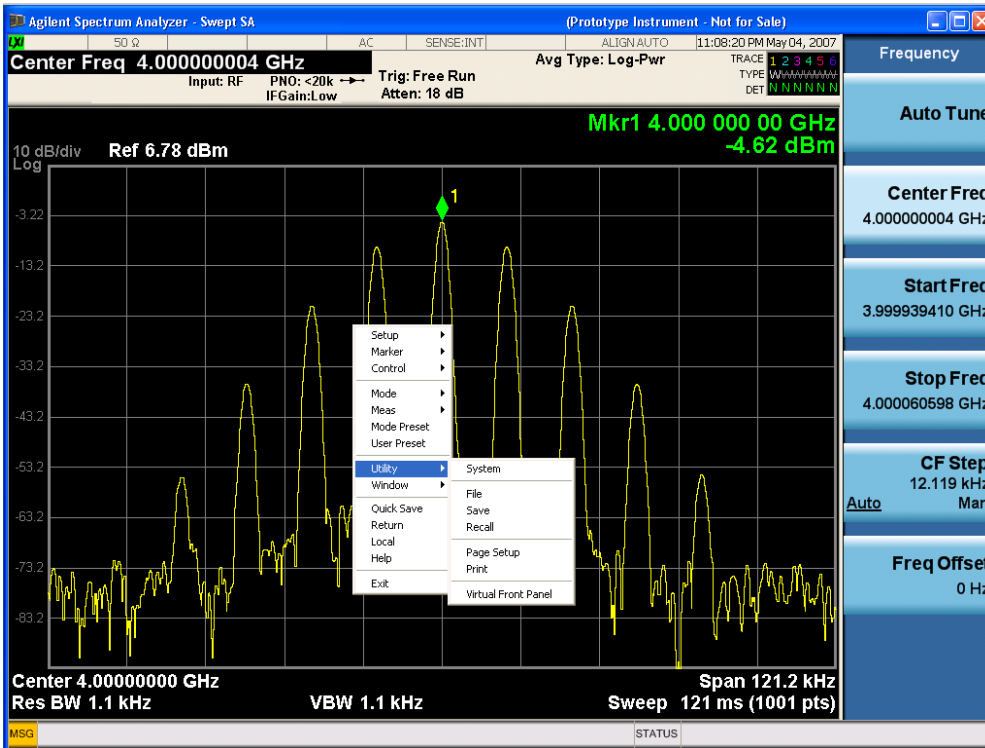

This method can be used to access any of the front-panel keys by using a mouse; as for example if you are accessing the instrument through Remote Desktop.

The array of keys thus available is shown below:

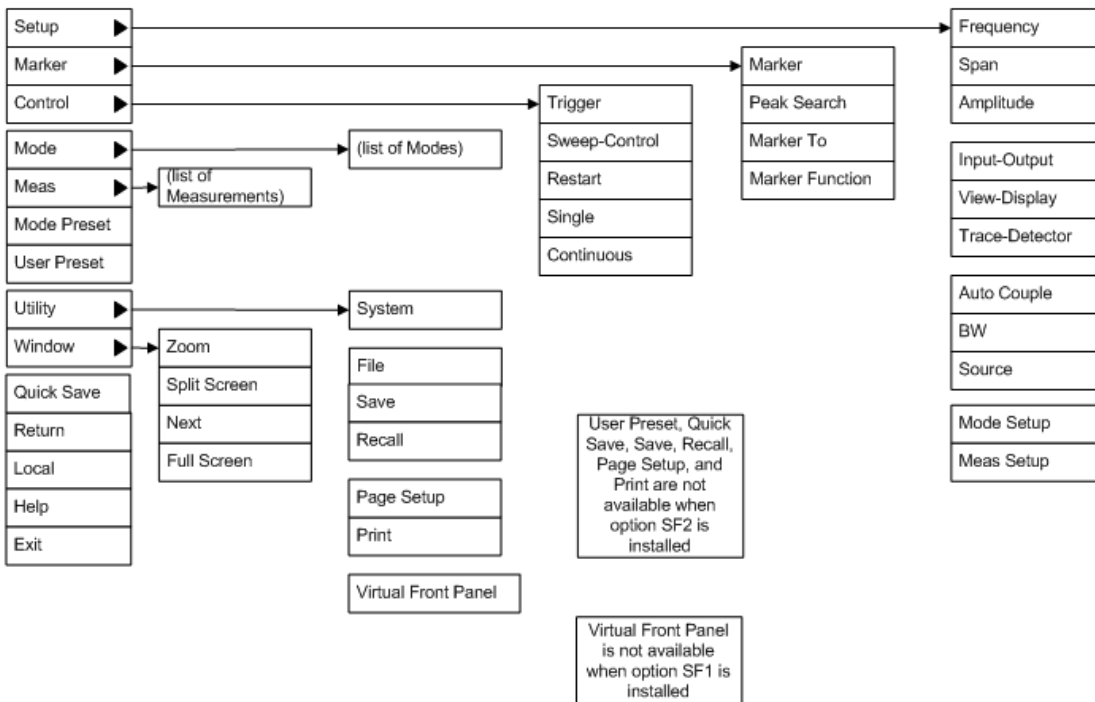

## PC Keyboard

If you have a PC keyboard plugged in (or via Remote Desktop), certain key codes on the PC keyboard map to front-panel keys on the GPSA front panel. These key codes are shown below:

Front-panel key	Key code
Frequency	CTRL+SHIFT+F
Span	CTRL+SHIFT+S
Amplitude	CTRL+SHIFT+A
Input/Output	CTRL+SHIFT+O
View/Display	CTRL+SHIFT+V
Trace/Detector	CTRL+ALT+T
Auto Couple	CTRL+SHIFT+C
Bandwidth	CTRL+ALT+B
Source	CTRL+ALT-U
Marker	CTRL+ALT+K
Peak Search	CTRL+ALT+P
Marker To	CTRL+ALT+N
Marker Function	CTRL+ALT+F
System	CTRL+SHIFT+Y
Quick Save	CTRL+Q
Save	CTRL+S
Recall	CTRL+R
Mode Preset	CTRL+M
User Preset	CTRL+U
Print	CTRL+P
File	CTRL+SHIFT+L
Mode	CTRL+SHIFT+M
Measure	CTRL+ALT+M
Mode Setup	CTRL+SHIFT+E
Meas Setup	CTRL+ALT+E
Trigger	CTRL+SHIFT+T
Sweep/Control	CTRL+SHIFT+W
Restart	CTRL+ALT+R
Single	CTRL+ALT+S
Cont	CTRL+ALT+C
Zoom	CTRL+SHIFT+Z
Next Window	CTRL+SHIFT+N
Split Screen	CTRL+L

Front-panel key	Key code
Full Screen	CTRL+SHIFT+B
Return	CTRL+SHIFT+R
Mute	Mute
Inc Audio	Volume Up
Dec Audio	Volume Down
Help	F1
Control	CTRL
Alt	ALT
Enter	Return
Cancel	Esc
Del	Delete
Backspace	Backspace
Select	Space
Up Arrow	Up
Down Arrow	Down
Left Arrow	Left
Right Arrow	Right
Menu key 1	CTRL+SHIFT+F1
Menu key 2	CTRL+SHIFT+F2
Menu key 3	CTRL+SHIFT+F3
Menu key 4	CTRL+SHIFT+F4
Menu key 5	CTRL+SHIFT+F5
Menu key 6	CTRL+SHIFT+F6
Menu key 7	CTRL+SHIFT+F7
Backspace	BACKSPACE
Enter	ENTER
Tab	Tab
1	1
2	2
3	3
4	4
5	5
6	6
7	7
8	8
9	9
0	0

1 About the Transceiver  
 Mouse and Keyboard Control

This is a pictorial view of the table:

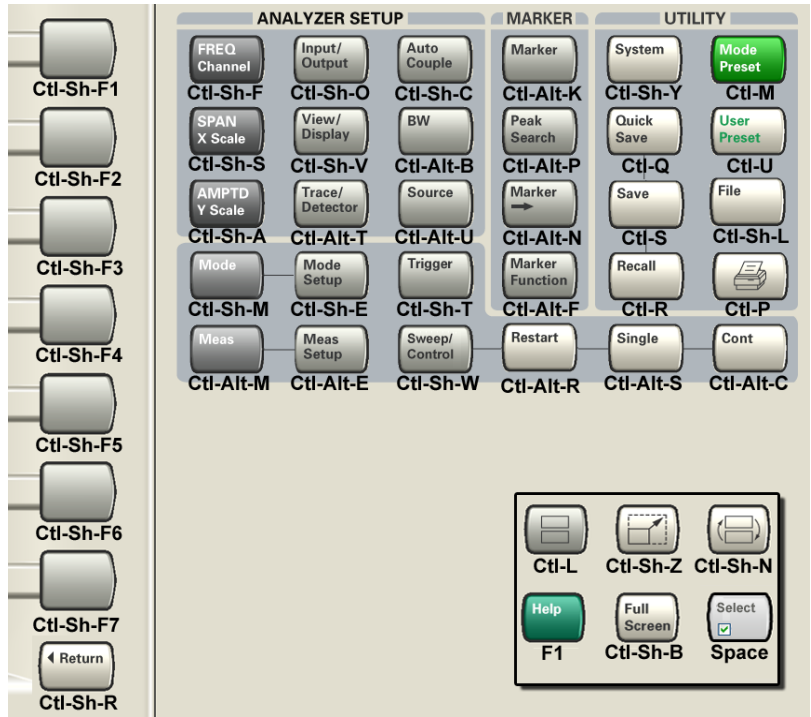



## 2 About the 802.16 OFDMA Measurement Application

This chapter provides overall information for the 802.16 OFDMA Mobile Measurement Application, which supports two similar wireless technologies: WiMAX and WiBro. To illustrate OFDMA measurements, this chapter describes only WiMAX-OFDMA examples for BTS and MS.

The IEEE 802.16 OFDMA wireless standard supports fixed and mobile wireless access (BWA) systems for metropolitan and area networks. The IEEE 802.16 standard is an OFDMA based system that supports a range of bandwidths (e.g. 1.25 MHz, 10 MHz, and 20 MHz) with fixed subcarrier spacing through use of a scalable architecture. The scalable architecture uses a scalable subchannelization structure with variable Fast Fourier Transform (FFT) sizes, where the FFT sizes scale with bandwidth to keep subcarrier spacing fixed.)

WiBro is a wireless broadband internet technology. WiBro base stations will offer an aggregate data throughput of 30 to 50 Mbits/s and cover a radius of 1 - 5 km, enabling portable internet usage within range of the base station. WiBro also offers Quality of Service (QoS). QoS enables WiBro to stream video content and other loss-sensitive data in a reliable manner.

The 802.16 OFDMA Measurement Application supports the following standards:

- IEEE 802.16e -2005
- WiBro (Korean mobile WiMAX OFDMA service)

The following measurements may be performed using the 802.16 OFDMA Measurement Application:

- Channel Power
- ACP
- Spectrum Emission Mask
- Modulation Analysis



### 3 Programming the Transceiver

This section provides introductory information about the programming documentation included with your product.

- ["What Programming Information is Available?" on page 64](#)
- ["STATus Subsystem " on page 65](#)
- ["IEEE 488.2 Common Commands" on page 107](#)

## What Programming Information is Available?

The M9420A Documentation can be accessed through the Additional Documentation page in the instrument Help system and is included on the Documentation DVD shipped with the instrument. It can also be found online at: [http://www.keysight.com/find/m9420a\\_manuals](http://www.keysight.com/find/m9420a_manuals).

The following resources are available to help you create programs for automating your unit:

Resource	Description
M9420A Programmer's Guide	Provides general SCPI programming information on the following topics: <ul style="list-style-type: none"><li>• Programming the X-Series Applications</li><li>• Programming fundamentals</li><li>• Programming with IVI driver</li></ul> Note that SCPI command descriptions for measurement applications are not in this book, but are in the User's and Programmer's Reference.
User's and Programmer's Reference manuals	Describes all virtual front panel keys, including SCPI commands for a measurement application. Note that: <ul style="list-style-type: none"><li>• Each measurement application has its own User's and Programmer's Reference.</li><li>• The content in this manual is duplicated in the instrument's Help (the Help that you see for a key is identical to what you see in this manual).</li></ul>
Embedded Help in your instrument	Describes all virtual front panel keys and softkeys, including SCPI commands, for a measurement application. Note that the content that you see in Help when you press a key is identical to what you see in the User's and Programmer's Reference.
M9420A Getting Started Guide	Provides valuable sections related to programming including: <ul style="list-style-type: none"><li>• Licensing New Measurement Application Software - After Initial Purchase</li><li>• Using the controller to connect to the transceiver</li></ul> This printed document is shipped with the instrument.

## STATus Subsystem

The following diagram provides a graphical overview of the entire X-Series Status Register System.

For readability, the diagram is split into two sections:

- ["X-Series Status Register System \(1\) " on page 66](#)
- ["X-Series Status Register System \(2\) " on page 67](#)

X-Series Status Register System (1)

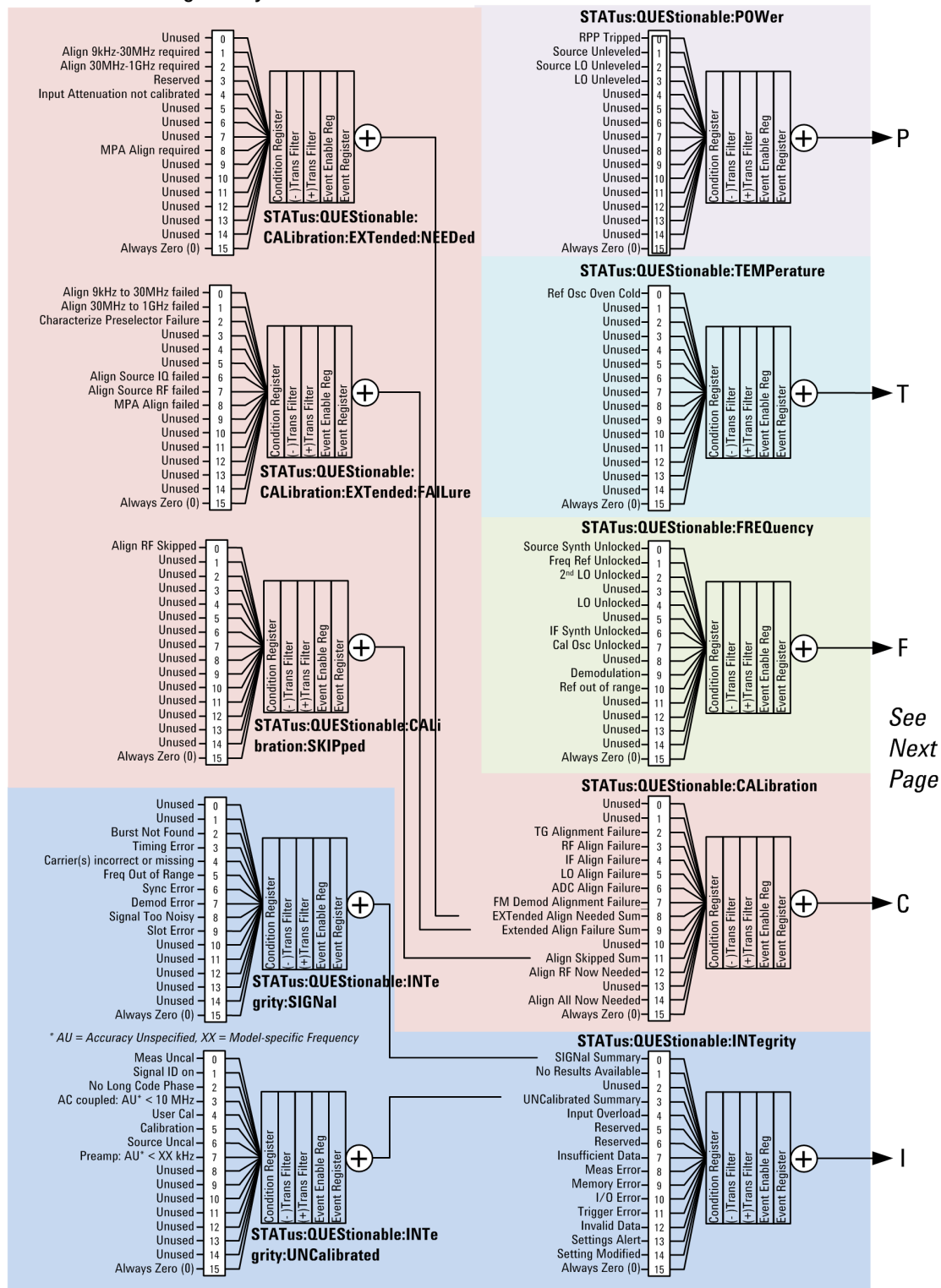

See Next Page

## X-Series Status Register System (2)

See  
 Previous  
 Page

P  
 T  
 F  
 C  
 I

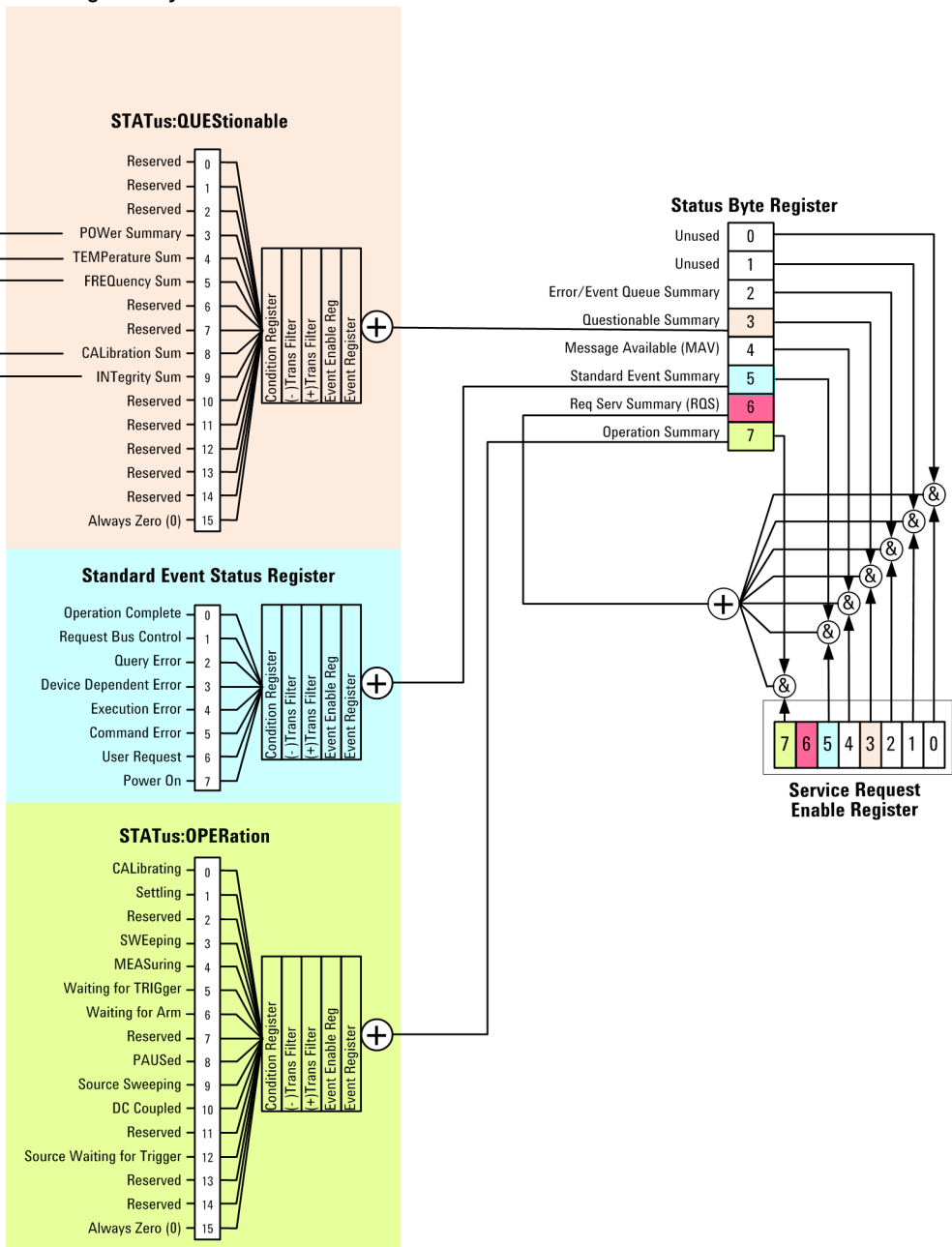

## Detailed Description

The STATus subsystem remote commands set and query the status hardware registers. This system of registers monitors various events and conditions in the instrument. Software written to control the instrument may need to monitor some of these events and conditions.

**NOTE**

All status register commands are sequential. Most commands can be started immediately and will overlap with any existing commands that are already running. This is not true of status commands. All the commands in the spectrum analyzer are assumed to be overlapped unless a command description specifically says that it is sequential.

## What Are Status Registers

The status system contains multiple registers that are arranged in a hierarchical order. The lower-level status registers propagate their data to the higher-level registers in the data structures by means of summary bits. The status byte register is at the top of the hierarchy and contains general status information for the instrument's events and conditions. All other individual registers are used to determine the specific events or conditions. For a diagram of the registers and their interconnections, see above.

The operation and questionable status registers are sets of registers that monitor the overall instrument condition. They are accessed with the STATus:OPERation and STATus:QUEStionable commands in the STATus command subsystem. Each register set is made up of five registers:

- Condition Register—It reports the real-time state of the signals monitored by this register set. There is no latching or buffering for a condition register.
- Positive Transition Register—This filter register controls which signals will set a bit in the event register when the signal makes a low to high transition (when the condition bit changes from 0 to 1).
- Negative Transition Register—This filter register controls which signals will set a bit in the event register when the signal makes a high to low transition (when the condition bit changes from 1 to 0).
- Event Register—It latches any signal state changes, in the way specified by the filter registers. Bits in the event register are never cleared by signal state changes. Event registers are cleared when read. They are also cleared by \*CLS and by presetting the instrument.
- Event Enable Register—It controls which of the bits, being set in the event register, will be summarized as a single output for the register set. Summary bits are then used by the next higher register.

The STATus:QUEStionable registers report abnormal operating conditions. The status register hierarchy is:

1. The summary outputs from the six STATus:QUEStionable:<keyword> detail registers are inputs to the STATus:QUEStionable register.
2. The summary output from the STATus:QUEStionable register is an input to the Status Byte Register. See the overall system in Figure at the beginning of this section.

The STATus:OPERation register set has no summarized inputs. The inputs to the STATus:OPERation:CONDition register indicate the real time state of the instrument. The STATus:OPERation:EVENT register summary output is an input to the Status Byte Register.

## What Are Status Register SCPI Commands

Most monitoring of the instrument conditions is done at the highest level using the IEEE common commands indicated below. Complete command descriptions are available in the IEEE commands section at the beginning of the language reference. Individual status registers can be set and queried using the commands in the STATus subsystem of the language reference.

- \*CLS (clear status) clears the status byte by emptying the error queue and clearing all the event registers.
- \*ESE, \*ESE? (event status enable) sets and queries the bits in the enable register part of the standard event status register.
- \*ESR? (event status register) queries and clears the event register part of the standard event status register.



- \*OPC, \*OPC? (operation complete) sets the standard event status register to monitor the completion of all commands. The query stops any new commands from being processed until the current processing is complete, then returns a '1'.
- \*PSC, \*PSC? (power-on state clear) sets the power-on state so that it clears the service request enable register and the event status enable register at power on.
- \*SRE, \*SRE? (service request enable) sets and queries the value of the service request enable register.
- \*STB? (status byte) queries the value of the status byte register without erasing its contents.

## How to Use the Status Registers

A program often needs to be able to detect and manage error conditions or changes in instrument status. There are two methods you can use to programmatically access the information in status registers:

- The polling method
- The service request (SRQ) method

In the polling method, the instrument has a passive role. It only tells the controller that conditions have changed when the controller asks the right question. In the SRQ method, the instrument takes a more active role. It tells the controller when there has been a condition change without the controller asking. Either method allows you to monitor one or more conditions.

The polling method works well if you do not need to know about changes the moment they occur. The SRQ method should be used if you must know immediately when a condition changes. To detect a change using the polling method, the program must repeatedly read the registers.

Use the SRQ method when:

- you need time-critical notification of changes
- you are monitoring more than one device which supports SRQs
- you need to have the controller do something else while waiting
- you can't afford the performance penalty inherent to polling

Use polling when:

- your programming language/development environment does not support SRQ interrupts
- you want to write a simple, single-purpose program and don't want the added complexity of setting up an SRQ handler
- To monitor a condition:
  - a. Determine which register contains the bit that reports the condition.
  - b. Send the unique SCPI query that reads that register.
  - c. Examine the bit to see if the condition has changed.

You can monitor conditions in different ways.

- Check the current instrument hardware and firmware status.

Do this by querying the condition registers which continuously monitor status. These registers represent the current state of the instrument. Bits in a condition register are updated in real time. When the condition monitored by a particular bit becomes true, the bit is set to 1. When the condition becomes false, the bit is reset to 0.

- Monitor a particular condition (bit).

You can enable a particular bit(s), using the event enable register. The instrument will then monitor that particular condition(s). If the bit becomes true (0 to 1 transition) in the event register, it will stay set until the event register is cleared. Querying the event register allows you to detect that this condition occurred even if the condition no longer exists. The event register can only be cleared by querying it or sending the \*CLS command.

- Monitor a particular type of change in a condition (bit).
  - The transition registers are preset to register if the condition goes from 0 to 1 (false to true, or a positive transition).
  - This can be changed so the selected condition is detected if the bit goes from 1 to 0 (true to false, or a negative transition).
  - It can also be set for both types of transitions occurring.
  - Or it can be set for neither transition. If both transition registers are set to 0 for a particular bit position, that bit will not be set in the event register for either type of change.

### Using a Status Register

Each bit in a register is represented by a numerical value based on its location. See figure below. This number is sent with the command to enable a particular bit. If you want to enable more than one bit, you would send the sum of all the bits that you want to monitor.

Figure: Status Register Bit Values

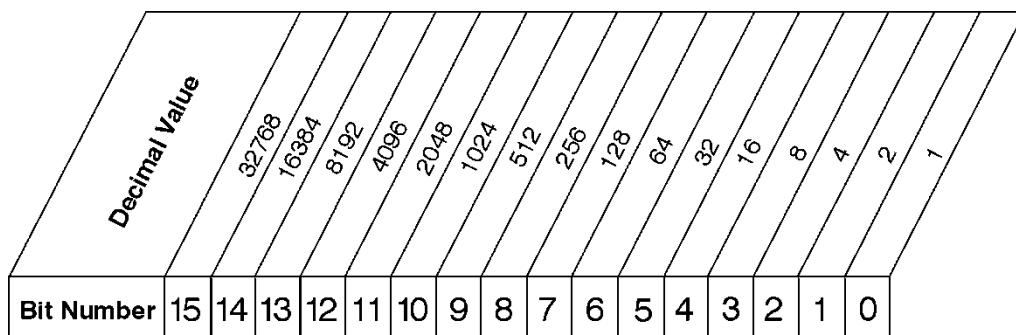

STATus:OPERation:ENABLE < num >  
 STATus:OPERation:ENABLE?

### Standard Operation Event Enable Register

ck730a

Bit 15 is not used to report status.

Example 1:

1. To enable bit 0 and bit 6 of standard event status register, you would send the command \*ESE 65 because 1 + 64 = 65.

- The results of a query are evaluated in a similar way. If the \*STB? command returns a decimal value of 140, ( $140 = 128 + 8 + 4$ ) then bit 7 is true, bit 3 is true and bit 2 is true.

Example 2:

- Suppose you want to know if an Auto-trigger Timeout occurs, but you only cared about that specific condition. So you would want to know what was happening with bit 10 in the Status Questionable Integrity register, and not about any other bits.
- It's usually a good idea to start by clearing all the status registers with \*CLS.
- Sending the STAT:QUES:INT:ENAB 1024 command lets you monitor only bit 10 events, instead of the default monitoring all the bits in the register. The register default is for positive transition events (0 to 1 transition). That is, when an auto-trigger timeout occurs. If instead, you wanted to know when the Auto-trigger timeout condition is cleared, then you would set the STAT:QUES:INT:PTR 0 and the STAT:QUES:INT:NTR 32767.
- So now the only output from the Status Questionable Integrity register will come from a bit 10 positive transition. That output goes to the Integrity Sum bit 9 of the Status Questionable register.
- You can do a similar thing with this register to only look at bit 9 using, STAT:QUES:ENAB 512.
- The Status Questionable register output goes to the "Status Questionable Summary" bit 3 of the Status Byte Register. The output from this register can be enabled using the \*SRE 8 command.
- Finally, you would use the serial polling functionality available for the particular bus/software that you are using to monitor the Status Byte Register. (You could also use \*STB? to poll the Status Byte Register.)

### Using the Service Request (SRQ) Method

Your language, bus, and programming environment must be able to support SRQ interrupts. (For example, BASIC used with VXI-11.3 (GPIB over LAN). When you monitor a condition with the SRQ method, you must:

- Determine which bit monitors the condition.
- Determine how that bit reports to the request service (RQS) bit of the status byte.
- Send SCPI commands to enable the bit that monitors the condition and to enable the summary bits that report the condition to the RQS bit.
- Enable the controller to respond to service requests.

When the condition changes, the instrument sets its RQS bit. The controller is informed of the change as soon as it occurs. As a result, the time the controller would otherwise have used to monitor the condition can be used to perform other tasks. Your program determines how the controller responds to the SRQ.

### Generating a Service Request

To use the SRQ method, you must understand how service requests are generated. Bit 6 of the status byte register is the request service (RQS) bit. The \*SRE command is used to configure the RQS bit to report changes in instrument status. When such a change occurs, the RQS bit is set. It is cleared when the status byte register is queried using \*SRE? (with a serial poll.) It can be queried without erasing the contents with \*STB?.

When a register set causes a summary bit in the status byte to change from 0 to 1, the instrument can initiate the service request (SRQ) process. However, the process is only initiated if both of the following conditions are true:

- The corresponding bit of the service request enable register is also set to 1.
- The instrument does not have a service request pending. (A service request is considered to be pending between the time the instrument's SRQ process is initiated and the time the controller reads the status byte register.)

The SRQ process sets the SRQ true. It also sets the status byte's request service (RQS) bit to 1. Both actions are necessary to inform the controller that the instrument requires service. Setting the SRQ line only informs the controller that some device on the bus requires service. Setting the RQS bit allows the controller to determine which instrument requires service.

If your program enables the controller to detect and respond to service requests, it should instruct the controller to perform a serial poll when the SRQ is set true. Each device on the bus returns the contents of its status byte register in response to this poll. The device whose RQS bit is set to 1 is the device that requested service.

When you read the instrument's status byte register with a serial poll, the RQS bit is reset to 0. Other bits in the register are not affected.

If the status register is configured to SRQ on end-of-measurement and the measurement is in continuous mode, then restarting a measurement (INIT command) can cause the measuring bit to pulse low. This causes an SRQ when you have not actually reached the "end-of-measurement" condition. To avoid this:

1. Set INITiate:CONTinuous off.
2. Set/enable the status registers.
3. Restart the measurement (send INIT).

## Status Register System

The hardware status registers are combined to form the instrument status system. Specific status bits are assigned to monitor various aspects of the instrument operation and status. See the diagram of the status system above for information about the bit assignments and status register interconnections.

### The Status Byte Register

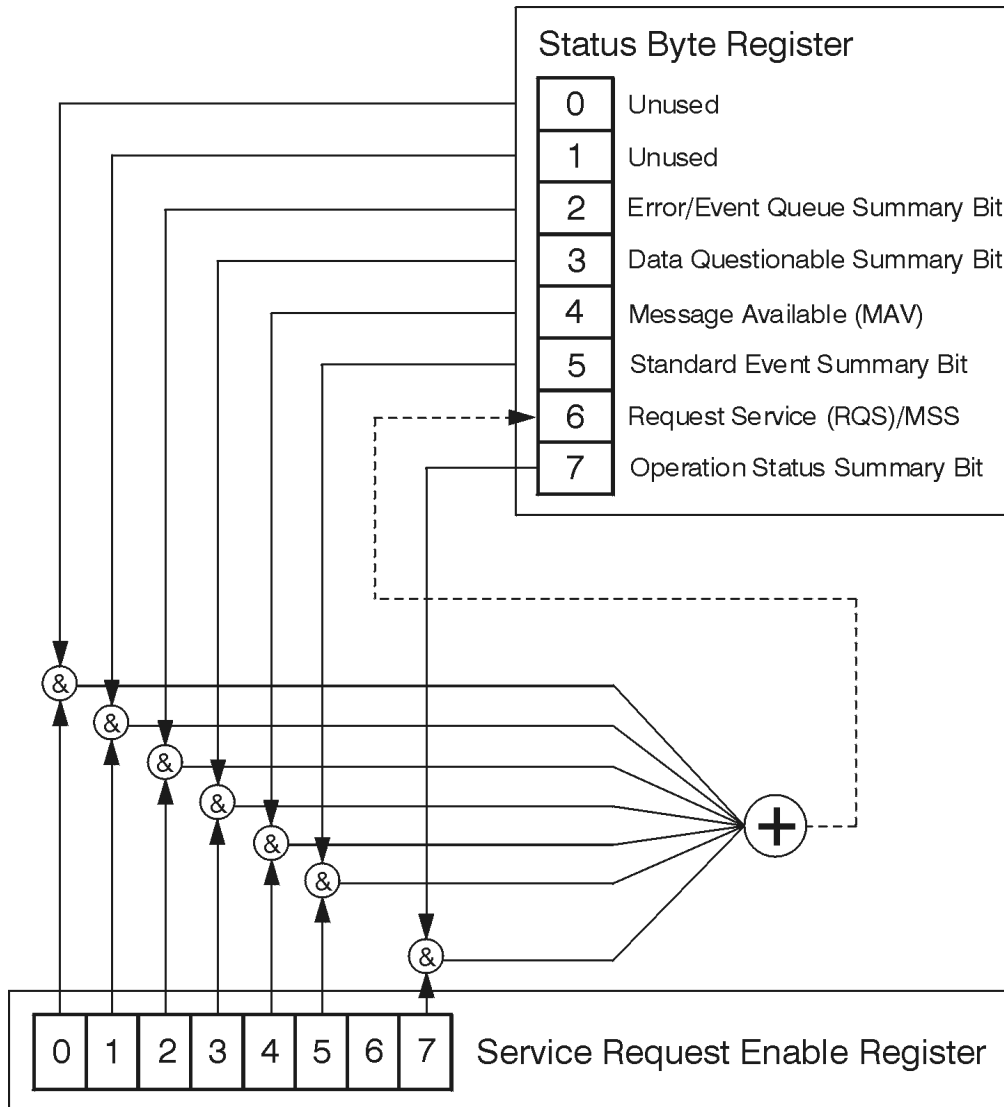

ck776a

The RQS bit is read and reset by a serial poll. The same bit position (MSS) is read, non-destructively by the \*STB? command. If you serial poll bit 6 it is read as RQS, but if you send \*STB it reads bit 6 as MSS. For more information refer to IEEE 488.2 standards, section 11.

	<b>Description</b>	Standard Operation Status Summary Bit	Request Service (RQS) Summary Bit	Standard Event Status Summary Bit	Message Available (MAV)	Data Questionable Status Summary Bit	Error/Event Queue Summary Bit	Unused	Unused
<b>Bit Number</b>	7	6	5	4	3	2	1	0	0

\*STB?

**Status Byte Register**

ck725a

Bit	Description
0, 1	These bits are always set to 0.
2	A 1 in this bit position indicates that the SCPI error queue is not empty which means that it contains at least one error message.
3	A 1 in this bit position indicates that the data questionable summary bit has been set. The data questionable event register can then be read to determine the specific condition that caused this bit to be set.
4	A 1 in this bit position indicates that the instrument has data ready in the output queue. There are no lower status groups that provide input to this bit.
5	A 1 in this bit position indicates that the standard event summary bit has been set. The standard event status register can then be read to determine the specific event that caused this bit to be set.
6	A 1 in this bit position indicates that the instrument has at least one reason to report a status change. This bit is also called the master summary status bit (MSS).
7	A 1 in this bit position indicates that the standard operation summary bit has been set. The standard operation event register can then be read to determine the specific condition that caused this bit to be set.

To query the status byte register, send the command \*STB?. The response will be the decimal sum of the bits which are set to 1. For example, if bit number 7 and bit number 3 are set to 1, the decimal sum of the 2 bits is 128 plus 8. So the decimal value 136 is returned. The \*STB command does not clear the status register.

In addition to the status byte register, the status byte group also contains the service request enable register. This register lets you choose which bits in the status byte register will trigger a service request.

Send the \*SRE <integer> command where <integer> is the sum of the decimal values of the bits you want to enable plus the decimal value of bit 6. For example, assume that you want to enable bit 7 so that whenever the standard operation status register summary bit is set to 1 it will trigger a service request. Send the command \*SRE 192 (because 192 = 128 + 64). You must always add 64 (the numeric value of RQS

bit 6) to your numeric sum when you enable any bits for a service request. The command \*SRE? returns the decimal value of the sum of the bits previously enabled with the \*SRE <integer> command.

The service request enable register presets to zeros (0).

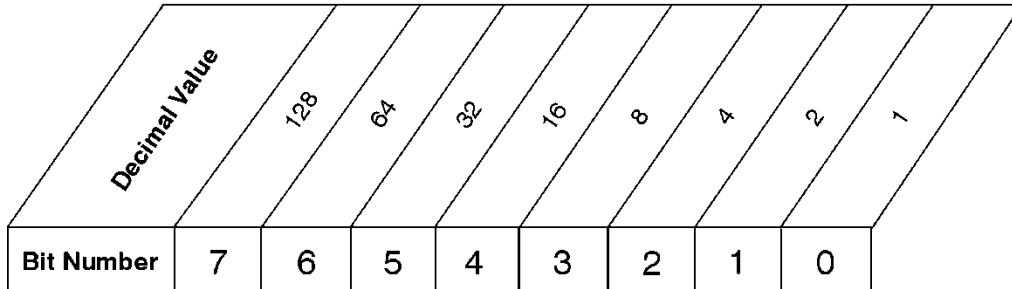

\*SRE <num>  
 \*SRE?

### Service Request Enable Register

ck726a

### Standard Event Status Register

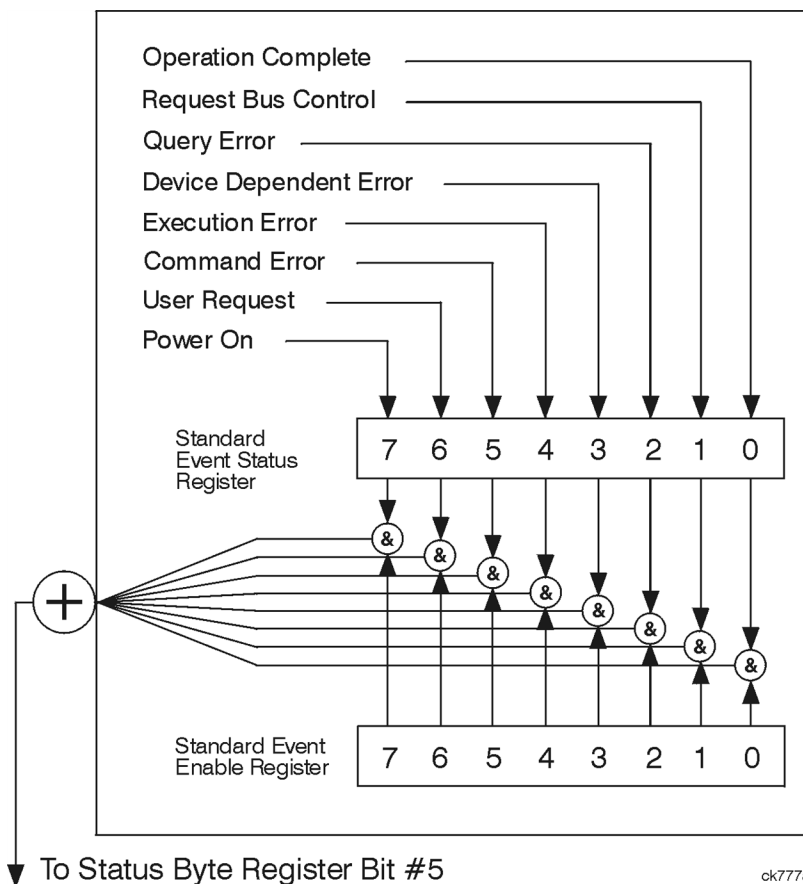

ck777a

The standard event status register contains the following bits:

<b>Bit Number</b>	<b>7</b>	<b>6</b>	<b>5</b>	<b>4</b>	<b>3</b>	<b>2</b>	<b>1</b>	<b>0</b>	

\*ESR?

**Standard Event Status Register**

ck727a

Bit	Description
0	A 1 in this bit position indicates that all pending operations were completed following execution of the *OPC command.
1	This bit is for GPIB handshaking to request control. Currently it is set to 0 because there are no implementations where the spectrum analyzer controls another instrument.
2	A 1 in this bit position indicates that a query error has occurred. Query errors have SCPI error numbers from -499 to -400.
3	A 1 in this bit position indicates that a device dependent error has occurred. Device dependent errors have SCPI error numbers from -399 to -300 and 1 to 32767.
4	A 1 in this bit position indicates that an execution error has occurred. Execution errors have SCPI error numbers from -299 to -200.
5	A 1 in this bit position indicates that a command error has occurred. Command errors have SCPI error numbers from -199 to -100.
6	A 1 in this bit position indicates that the LOCAL key has been pressed. This is true even if the instrument is in local lockout mode.
7	A 1 in this bit position indicates that the instrument has been turned off and then on.

The standard event status register is used to determine the specific event that set bit 5 in the status byte register. To query the standard event status register, send the command \*ESR?. The response will be the decimal sum of the bits which are enabled (set to 1). For example, if bit number 7 and bit number 3 are enabled, the decimal sum of the 2 bits is 128 plus 8. So the decimal value 136 is returned.

In addition to the standard event status register, the standard event status group also contains a standard event status enable register. This register lets you choose which bits in the standard event status register will set the summary bit (bit 5 of the status byte register) to 1. Send the \*ESE <integer> command where <integer> is the sum of the decimal values of the bits you want to enable. For example, to enable bit 7 and bit 6 so that whenever either of those bits is set to 1, the standard event status summary bit of the status



byte register will be set to 1, send the command \*ESE 192 (128 + 64). The command \*ESE? returns the decimal value of the sum of the bits previously enabled with the \*ESE <integer> command.

The standard event status enable register presets to zeros (0).

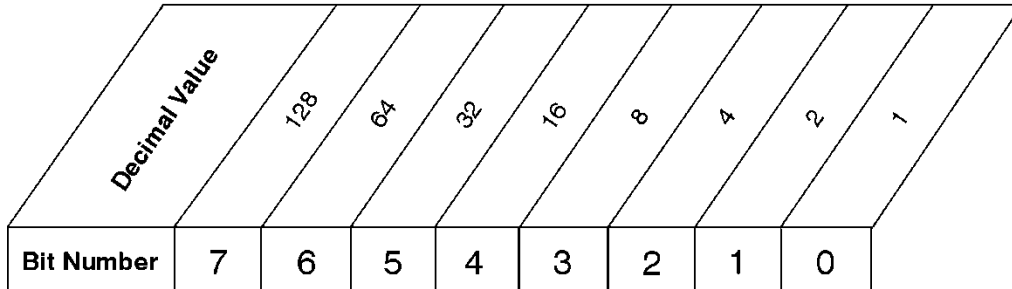

\*ESE <num>  
 \*ESE?

**Standard Event Status Enable Register**

ck728a

**Operation and Questionable Status Registers**

The operation and questionable status registers are registers that monitor the overall instrument condition. They are accessed with the STATUS:OPERation and STATUS:QUESTionable commands in the STATUS command subsystem. See the figure at the beginning of this chapter.

**Operation Status Register**

The operation status register monitors the current instrument measurement state. It checks to see if the instrument is calibrating, sweeping, or waiting for a trigger. For more information see the \*OPC? command located in the IEEE Common Commands section.

Bit	Condition	Operation
0	Calibrating	The instrument is busy executing its Align Now process
3	Sweeping	The instrument is busy taking a sweep.
4	Measuring	The instrument is busy making a measurement. Measurements often require multiple sweeps. They are initiated by keys under the MEASURE key or with the MEASure group of commands. The bit is valid for most X-Series Modes.
5	Waiting for trigger	The instrument is waiting for the trigger conditions to be met, then it will trigger a sweep or measurement.

**Questionable Status Register**

The questionable status register monitors the instrument's condition to see if anything questionable has happened to it. It is looking for anything that might cause an error or a bad measurement like a hardware problem, an out of calibration situation, or a unusual signal. All the bits are summary bits from lower-level event registers.

Bit	Condition	Operation
-----	-----------	-----------

3	Power summary	The instrument hardware has detected a power unlevelled condition.
4	Temperature summary	The instrument is still warming up.
5	Frequency summary	The instrument hardware has detected an unlocked condition or a problem with the external frequency reference.
8	Calibration summary	The instrument has detected a hardware problem while doing the automatic internal alignment process.
9	Integrity summary	The instrument has detected a questionable measurement condition such as: bad timing, bad signal/data, timeout problem, signal overload, or "meas uncal".

### STATus Subsystem Command Descriptions

The STATus subsystem controls the SCPI-defined instrument status reporting structures. Each status register has a set of five commands used for querying or masking that particular register.

Numeric values for bit patterns can be entered using decimal or hexadecimal representations. (i.e. 0 to 32767 is equivalent to #H0 to #H7FFF. It is also equal to all ones, 11111111111111) See the SCPI Basics information about using bit patterns for variable parameters.

#### Operation Register

"Operation Condition Query" on page 78

"Operation Enable" on page 79

"Operation Event Query" on page 79

"Operation Negative Transition" on page 79

"Operation Positive Transition" on page 80

#### Operation Condition Query

This query returns the decimal value of the sum of the bits in the Status Operation Condition register.

**NOTE**

The data in this register is continuously updated and reflects the current conditions.

Mode	All
<b>Remote Command</b>	:STATus:OPERation:CONDition?
<b>Example</b>	STAT:OPER:COND?
Preset	0
Status Bits/OPC dependencies	Sequential command
Initial S/W Revision	Prior to A.02.00

## Operation Enable

This command determines which bits in the Operation Event register, will set the Operation Status Summary bit (bit 7) in the Status Byte Register. The variable <integer> is the sum of the decimal values of the bits you want to enable.

**NOTE**

The preset condition is to have all bits in this enable register set to 0. To have any Operation Events reported to the Status Byte Register, one or more bits need to be set to 1.

Mode	All
<b>Remote Command</b>	:STATus:OPERation:ENABle <integer> :STATus:OPERation:ENABle?
<b>Example</b>	STAT:OPER:ENAB 1 Sets the register so that Align Now operation will be reported to the Status Byte Register.
Preset	0
Min	0
Max	32767
Status Bits/OPC dependencies	Sequential command
Initial S/W Revision	Prior to A.02.00

## Operation Event Query

This query returns the decimal value of the sum of the bits in the Operation Event register.

**NOTE**

The register requires that the associated PTR or NTR filters be set before a condition register bit can set a bit in the event register. The data in this register is latched until it is queried. Once queried, the register is cleared.

Mode	All
<b>Remote Command</b>	:STATus:OPERation[:EVENT]?
<b>Example</b>	STAT:OPER?
Preset	0
Status Bits/OPC dependencies	Sequential command
Initial S/W Revision	Prior to A.02.00

## Operation Negative Transition

This command determines which bits in the Operation Condition register will set the corresponding bit in the Operation Event register when the condition register bit has a negative transition (1 to 0). The variable <integer> is the sum of the decimal values of the bits that you want to enable.

Mode	All
<b>Remote Command</b>	:STATus:OPERation:NTRansition <integer> :STATus:OPERation:NTRansition?
<b>Example</b>	STAT:OPER:NTR 1 Align Now operation complete will be reported to the Status Byte Register.
Preset	0
Min	0
Max	32767
Status Bits/OPC dependencies	Sequential command
Initial S/W Revision	Prior to A.02.00

### Operation Positive Transition

This command determines which bits in the Operation Condition register will set the corresponding bit in the Operation Event register when the condition register bit has a positive transition (0 to 1). The variable <integer> is the sum of the decimal values of the bits that you want to enable.

Mode	All
<b>Remote Command</b>	:STATus:OPERation:PTRansition <integer> :STATus:OPERation:PTRansition?
<b>Example</b>	STAT:OPER:PTR 1 Align Now operation beginning will be reported to the Status Byte Register.
Preset	32767
Min	0
Max	32767
Status Bits/OPC dependencies	Sequential command
Initial S/W Revision	Prior to A.02.00

### Preset the Status Byte

Sets bits in most of the enable and transition registers to their default state. It presets all the Transition Filters, Enable Registers, and the Error/Event Queue Enable. It has no effect on Event Registers, Error/Event QUEUE, IEEE 488.2 ESE, and SRE Registers as described in IEEE Standard 488.2–1992, IEEE Standard Codes, Formats, Protocols, and Common Commands for Use with ANSI/IEEE Std 488.1–1987. New York, NY, 1992.

<b>Remote Command</b>	:STATus:PRESet
<b>Example</b>	STAT:PRES
Initial S/W Revision	Prior to A.02.00

## Questionable Register

"Questionable Condition " on page 81

"Questionable Enable " on page 81

"Questionable Event Query " on page 82

"Questionable Negative Transition " on page 82

"Questionable Positive Transition" on page 82

## Questionable Condition

This query returns the decimal value of the sum of the bits in the Questionable Condition register.

**NOTE**

The data in this register is continuously updated and reflects the current conditions.

Mode	All
<b>Remote Command</b>	:STATus:QUESTionable:CONDition?
<b>Example</b>	STAT:QUES:COND?
Preset	0
Status Bits/OPC dependencies	Sequential command
Initial S/W Revision	Prior to A.02.00

## Questionable Enable

This command determines which bits in the Questionable Event register will set the Questionable Status Summary bit (bit3) in the Status Byte Register. The variable <integer> is the sum of the decimal values of the bits you want to enable.

**NOTE**

The preset condition is all bits in this enable register set to 0. To have any Questionable Events reported to the Status Byte Register, one or more bits need to be set to 1. The Status Byte Event Register should be queried after each measurement to check the Questionable Status Summary (bit 3). If it is equal to 1, a condition during the test may have made the test results invalid. If it is equal to 0, this indicates that no hardware problem or measurement problem was detected by the analyzer.

Mode	All
<b>Remote Command</b>	:STATus:QUESTionable:ENABle <integer> :STATus:QUESTionable:ENABle?
<b>Example</b>	STAT:OPER:PTR 1 Align Now operation beginning will be reported to the Status Byte Register.
Preset	0
Min	0
Max	32767
Status Bits/OPC dependencies	Sequential command

---

Initial S/W Revision	Prior to A.02.00
----------------------	------------------

---

### Questionable Event Query

This query returns the decimal value of the sum of the bits in the Questionable Event register.

**NOTE** The register requires that the associated PTR or NTR filters be set before a condition register bit can set a bit in the event register. The data in this register is latched until it is queried. Once queried, the register is cleared.

---

Mode	All
<b>Remote Command</b>	:STATus:QUEStionable[:EVENT]?
<b>Example</b>	STAT:QUES?
Preset	0
Status Bits/OPC dependencies	Sequential command
Initial S/W Revision	Prior to A.02.00

---

### Questionable Negative Transition

This command determines which bits in the Questionable Condition register will set the corresponding bit in the Questionable Event register when the condition register bit has a negative transition (1 to 0). The variable <integer> is the sum of the decimal values of the bits that you want to enable.

---

Mode	All
<b>Remote Command</b>	:STATus:QUEStionable:NTRansition <integer> :STATus:QUEStionable:NTRansition?
<b>Example</b>	STAT:QUES:NTR 16 Temperature summary 'questionable cleared' will be reported to the Status Byte Register.
Preset	0
Min	0
Max	32767
Status Bits/OPC dependencies	Sequential command
Initial S/W Revision	Prior to A.02.00

---

### Questionable Positive Transition

This command determines which bits in the Questionable Condition register will set the corresponding bit in the Questionable Event register when the condition register bit has a positive transition (0 to 1). The variable <integer> is the sum of the decimal values of the bits that you want to enable.

Mode	All
<b>Remote Command</b>	:STATus:QUEStionable:PTRansition <integer> :STATus:QUEStionable:PTRansition?
<b>Example</b>	STAT:QUES:PTR 16 Temperature summary 'questionable asserted' will be reported to the Status Byte Register.
Preset	32767
Min	0
Max	32767
Status Bits/OPC dependencies	Sequential command
Initial S/W Revision	Prior to A.02.00

### Questionable Calibration Register

"Questionable Calibration Condition " on page 83

"Questionable Calibration Enable " on page 83

"Questionable Calibration Event Query " on page 84

"Questionable Calibration Negative Transition " on page 84

"Questionable Calibration Positive Transition " on page 85

### Questionable Calibration Condition

This query returns the decimal value of the sum of the bits in the Questionable Calibration Condition register.

**NOTE**

The data in this register is continuously updated and reflects the current conditions.

Mode	All
<b>Remote Command</b>	:STATus:QUEStionable:CALibration:CONDition?
<b>Example</b>	STAT:QUES:CAL:COND?
Preset	0
Status Bits/OPC dependencies	Sequential command
Initial S/W Revision	Prior to A.02.00

### Questionable Calibration Enable

This command determines which bits in the Questionable Calibration Condition Register will set bits in the Questionable Calibration Event register, which also sets the Calibration Summary bit (bit 8) in the

Questionable Register. The variable <integer> is the sum of the decimal values of the bits you want to enable.

Mode	All
<b>Remote Command</b>	:STATus:QUESTionable:CALibration:ENABle <integer> :STATus:QUESTionable:CALibration:ENABle?
<b>Example</b>	STAT:QUES:CAL:ENAB 16384 Can be used to query if an alignment is needed, if you have turned off the automatic alignment process.
Min	0
Max	32767
Status Bits/OPC dependencies	Sequential command
Initial S/W Revision	Prior to A.02.00

### Questionable Calibration Event Query

This query returns the decimal value of the sum of the bits in the Questionable Calibration Event register.

**NOTE**

The register requires that the associated PTR or NTR filters be set before a condition register bit can set a bit in the event register. The data in this register is latched until it is queried. Once queried, the register is cleared.

Mode	All
<b>Remote Command</b>	:STATus:QUESTionable:CALibration[:EVENT]?
<b>Example</b>	STAT:QUES:CAL?
Preset	0
Status Bits/OPC dependencies	Sequential command
Initial S/W Revision	Prior to A.02.00

### Questionable Calibration Negative Transition

This command determines which bits in the Questionable Calibration Condition register will set the corresponding bit in the Questionable Calibration Event register when the condition register bit has a negative transition (1 to 0). The variable <integer> is the sum of the decimal values of the bits that you want to enable.

Mode	All
<b>Remote Command</b>	:STATus:QUESTionable:CALibration:NTRansition <integer> :STATus:QUESTionable:CALibration:NTRansition?
<b>Example</b>	STAT:QUES:CAL:NTR 16384 Alignment is not required.
Preset	0



Min	0
Max	32767
Status Bits/OPC dependencies	Sequential command
Initial S/W Revision	Prior to A.02.00

### Questionable Calibration Positive Transition

This command determines which bits in the Questionable Calibration Condition register will set the corresponding bit in the Questionable Calibration Event register when the condition register bit has a positive transition (0 to 1). The variable <integer> is the sum of the decimal values of the bits that you want to enable.

Mode	All
<b>Remote Command</b>	:STATus:QUEStionable:CALibration:PTRansition <integer> :STATus:QUEStionable:CALibration:PTRansition?
<b>Example</b>	STAT:QUES:CAL:PTR 16384 Alignment is required.
Preset	32767
Min	0
Max	32767
Status Bits/OPC dependencies	Sequential command
Initial S/W Revision	Prior to A.02.00

### Questionable Calibration Skipped Register

"Questionable Calibration Skipped Condition " on page 85

"Questionable Calibration Skipped Enable " on page 86

"Questionable Calibration Skipped Event Query " on page 86

"Questionable Calibration Skipped Negative Transition " on page 87

"Questionable Calibration Skipped Positive Transition " on page 87

### Questionable Calibration Skipped Condition

This query returns the decimal value of the sum of the bits in the Questionable Calibration Skipped Condition register.

**NOTE** The data in this register is continuously updated and reflects the current conditions.

Mode	All
------	-----

<b>Remote Command</b>	:STATus:QUESTionable:CALibration:SKIpped:CONDition?
<b>Example</b>	STAT:QUES:CAL:SKIP:COND?
Preset	0
Status Bits/OPC dependencies	Sequential command
Initial S/W Revision	Prior to A.02.00

### Questionable Calibration Skipped Enable

This command determines which bits in the Questionable Calibration Skipped Condition Register will set bits in the Questionable Calibration Skipped Event register, which also sets bit 11 of the Questionable Calibration Register. The variable <integer> is the sum of the decimal values of the bits you want to enable.

Mode	All
<b>Remote Command</b>	:STATus:QUESTionable:CALibration:SKIpped:ENABle <integer> :STATus:QUESTionable:CALibration:SKIpped:ENABle?
<b>Example</b>	STAT:QUES:CAL:SKIP:ENAB 1 Can be used to query if an EMI alignment skipped condition is detected
Preset	32767
Min	0
Max	32767
Status Bits/OPC dependencies	Sequential command
Initial S/W Revision	Prior to A.02.00

### Questionable Calibration Skipped Event Query

This query returns the decimal value of the sum of the bits in the Questionable Calibration Event register.

**NOTE**

The register requires that the associated PTR or NTR filters be set before a condition register bit can set a bit in the event register. The data in this register is latched until it is queried. Once queried, the register is cleared.

Mode	All
<b>Remote Command</b>	:STATus:QUESTionable:CALibration:SKIpped[:EVENT]?
<b>Example</b>	STAT:QUES:CAL:SKIP?
Preset	0
Status Bits/OPC dependencies	Sequential command
Initial S/W Revision	Prior to A.02.00

### Questionable Calibration Skipped Negative Transition

This command determines which bits in the Questionable Calibration Skipped Condition register will set the corresponding bit in the Questionable Calibration Skipped Event register when the condition register bit has a negative transition (1 to 0). The variable <integer> is the sum of the decimal values of the bits that you want to enable.

Mode	All
<b>Remote Command</b>	:STATus:QUEStionable:CALibration:SKIPped:NTRansition <integer> :STATus:QUEStionable:CALibration:SKIPped:NTRansition?
<b>Example</b>	STAT:QUES:CAL:SKIP:NTR 1 Align RF skipped is not required.
Preset	0
Min	0
Max	32767
Status Bits/OPC dependencies	Sequential command
Initial S/W Revision	Prior to A.02.00

### Questionable Calibration Skipped Positive Transition

This command determines which bits in the Questionable Calibration Skipped Condition register will set the corresponding bit in the Questionable Calibration Skipped Event register when the condition register bit has a positive transition (0 to 1). The variable <integer> is the sum of the decimal values of the bits that you want to enable.

Mode	All
<b>Remote Command</b>	:STATus:QUEStionable:CALibration:SKIPped:PTRansition <integer> :STATus:QUEStionable:CALibration:SKIPped:PTRansition?
<b>Example</b>	STAT:QUES:CAL:SKIP:PTR 1 Align RF skipped is required.
Preset	32767
Min	0
Max	32767
Status Bits/OPC dependencies	Sequential command
Initial S/W Revision	Prior to A.02.00

### Questionable Calibration Extended Failure Register

["Questionable Calibration Extended Failure Condition " on page 88](#)

["Questionable Calibration Extended Failure Enable " on page 88](#)

["Questionable Calibration Extended Failure Event Query " on page 88](#)

["Questionable Calibration Extended Failure Negative Transition " on page 89](#)

"Questionable Calibration Extended Failure Positive Transition " on page 89

### Questionable Calibration Extended Failure Condition

This query returns the decimal value of the sum of the bits in the Questionable Calibration Extended Failure Condition register.

**NOTE** The data in this register is continuously updated and reflects the current conditions.

Mode	All
<b>Remote Command</b>	:STATus:QUESTionable:CALibration:EXTended:FAILure:CONDition?
<b>Example</b>	STAT:QUES:CAL:EXT:FAIL:COND?
Preset	0
Status Bits/OPC dependencies	Sequential command
Initial S/W Revision	Prior to A.02.00

### Questionable Calibration Extended Failure Enable

This command determines which bits in the Questionable Calibration Extended Failure Condition Register will set bits in the Questionable Calibration Extended Failure Event register, which also sets bit 9 of the Questionable Calibration Register. The variable <integer> is the sum of the decimal values of the bits you want to enable.

Mode	All
<b>Remote Command</b>	:STATus:QUESTionable:CALibration:EXTended:FAILure:ENABle <integer> :STATus:QUESTionable:CALibration:EXTended:FAILure:ENABle?
<b>Example</b>	STAT:QUES:CAL:EXT:FAIL:ENAB 1 Can be used to query if an EMI conducted alignment is needed.
Preset	32767
Min	0
Max	32767
Status Bits/OPC dependencies	Sequential command
Initial S/W Revision	Prior to A.02.00

### Questionable Calibration Extended Failure Event Query

This query returns the decimal value of the sum of the bits in the Questionable Calibration Extended Failure Event register.

**NOTE** The register requires that the associated PTR or NTR filters be set before a condition register bit can set a bit in the event register. The data in this register is latched until it is queried. Once queried, the register is cleared.

Mode	All
<b>Remote Command</b>	:STATus:QUESTionable:CALibration:EXTended:FAILure[:EVENT]?
<b>Example</b>	STAT:QUES:CAL:EXT:FAIL?
Preset	0
Status Bits/OPC dependencies	Sequential command
Initial S/W Revision	Prior to A.02.00

### Questionable Calibration Extended Failure Negative Transition

This command determines which bits in the Questionable Calibration Extended Failure Condition register will set the corresponding bit in the Questionable Calibration Extended Failure Event register when the condition register bit has a negative transition (1 to 0). The variable <integer> is the sum of the decimal values of the bits that you want to enable.

Mode	All
<b>Remote Command</b>	:STATus:QUESTionable:CALibration:EXTended:FAILure:NTRansition <integer> :STATus:QUESTionable:CALibration:EXTended:FAILure:NTRansition?
<b>Example</b>	STAT:QUES:CAL:EXT:FAIL:NTR 1 EMI conducted align failure is not required.
Preset	0
Min	0
Max	32767
Status Bits/OPC dependencies	Sequential command
Initial S/W Revision	Prior to A.02.00

### Questionable Calibration Extended Failure Positive Transition

This command determines which bits in the Questionable Calibration Extended Failure Condition register will set the corresponding bit in the Questionable Calibration Extended Failure Event register when the condition register bit has a positive transition (0 to 1). The variable <integer> is the sum of the decimal values of the bits that you want to enable.

Mode	All
<b>Remote Command</b>	:STATus:QUESTionable:CALibration:EXTended:FAILure:PTRansition <integer> :STATus:QUESTionable:CALibration:EXTended:FAILure:PTRansition?
<b>Example</b>	STAT:QUES:CAL:EXT:FAIL:PTR 1 EMI conducted align failure is required.
Preset	32767
Min	0
Max	32767

Status Bits/OPC dependencies	Sequential command
Initial S/W Revision	Prior to A.02.00

### Questionable Calibration Extended Needed Register

"Questionable Calibration Extended Needed Condition " on page 90

"Questionable Calibration Extended Needed Enable " on page 90

"Questionable Calibration Extended Needed Event Query " on page 91

"Questionable Calibration Extended Needed Negative Transition " on page 91

"Questionable Calibration Extended Needed Positive Transition " on page 92

### Questionable Calibration Extended Needed Condition

This query returns the decimal value of the sum of the bits in the Questionable Calibration Extended Needed Condition register.

**NOTE**

The data in this register is continuously updated and reflects the current conditions.

Mode	All
Remote Command	:STATus:QUESTionable:CALibration:EXTended:NEEDed:CONDition?
Example	STAT:QUES:CAL:EXT:NEED:COND?
Preset	0
Status Bits/OPC dependencies	Sequential command
Initial S/W Revision	Prior to A.02.00

### Questionable Calibration Extended Needed Enable

This command determines which bits in the Questionable Calibration Extended Needed Condition Register will set bits in the Questionable Calibration Extended Needed Event register, which also sets bit 14 of the Questionable Calibration Register. The variable <integer> is the sum of the decimal values of the bits you want to enable.

Mode	All
Remote Command	:STATus:QUESTionable:CALibration:EXTended:NEEDed:ENABle <integer> :STATus:QUESTionable:CALibration:EXTended:NEEDed:ENABle?
Example	STAT:QUES:CAL:EXT:NEED:ENAB 2 Can be used to query if an EMI conducted alignment is needed.
Preset	32767
Min	0

Max	32767
Status Bits/OPC dependencies	Sequential command
Initial S/W Revision	Prior to A.02.00

### Questionable Calibration Extended Needed Event Query

This query returns the decimal value of the sum of the bits in the Questionable Calibration Extended Needed Event register.

**NOTE**

The register requires that the associated PTR or NTR filters be set before a condition register bit can set a bit in the event register. The data in this register is latched until it is queried. Once queried, the register is cleared.

Mode	All
<b>Remote Command</b>	:STATus:QUESTionable:CALibration:EXTended:NEEDED[:EVENT]?
<b>Example</b>	STAT:QUES:CAL:EXT:NEED?
Preset	0
Status Bits/OPC dependencies	Sequential command
Initial S/W Revision	Prior to A.02.00

### Questionable Calibration Extended Needed Negative Transition

This command determines which bits in the Questionable Calibration Extended Needed Condition register will set the corresponding bit in the Questionable Calibration Extended Needed Event register when the condition register bit has a negative transition (1 to 0). The variable <integer> is the sum of the decimal values of the bits that you want to enable.

Mode	All
<b>Remote Command</b>	:STATus:QUESTionable:CALibration:EXTended:NEEDED:NTRansition <integer> :STATus:QUESTionable:CALibration:EXTended:NEEDED:NTRansition?
<b>Example</b>	STAT:QUES:CAL:EXT:NEED:NTR 2 Align EMI conducted is not required.
Preset	0
Min	0
Max	32767
Status Bits/OPC dependencies	Sequential command
Initial S/W Revision	Prior to A.02.00

### Questionable Calibration Extended Needed Positive Transition

This command determines which bits in the Questionable Calibration Extended Needed Condition register will set the corresponding bit in the Questionable Calibration Extended Needed Event register when the condition register bit has a positive transition (0 to 1). The variable <integer> is the sum of the decimal values of the bits that you want to enable.

Mode	All
<b>Remote Command</b>	:STATus:QUESTionable:CALibration:EXTended:NEEDed:PTRansition <integer> :STATus:QUESTionable:CALibration:EXTended:NEEDed:PTRansition?
<b>Example</b>	STAT:QUES:CAL:EXT:NEED:PTR 2 Align EMI conducted is required.
Preset	32767
Min	0
Max	32767
Status Bits/OPC dependencies	Sequential command
Initial S/W Revision	Prior to A.02.00

### Questionable Frequency Register

"Questionable Frequency Condition " on page 92

"Questionable Frequency Enable " on page 93

"Questionable Frequency Event Query " on page 93

"Questionable Frequency Negative Transition " on page 93

"Questionable Frequency Positive Transition " on page 94

### Questionable Frequency Condition

This query returns the decimal value of the sum of the bits in the Questionable Frequency Condition register.

**NOTE** The data in this register is continuously updated and reflects the current conditions.

Mode	All
<b>Remote Command</b>	:STATus:QUESTionable:FREQuency:CONDition?
<b>Example</b>	STAT:QUES:FREQ:COND?
Preset	0
Status Bits/OPC dependencies	Sequential command
Initial S/W Revision	Prior to A.02.00



### Questionable Frequency Enable

This command determines which bits in the Questionable Frequency Condition Register will set bits in the Questionable Frequency Event register, which also sets the Frequency Summary bit (bit 5) in the Questionable Register. The variable <integer> is the sum of the decimal values of the bits you want to enable.

Mode	All
<b>Remote Command</b>	:STATus:QUEStionable:FREQuency:ENABle <integer> :STATus:QUEStionable:FREQuency:ENABle?
<b>Example</b>	STAT:QUES:FREQ:ENAB 2 Frequency Reference Unlocked will be reported to the Frequency Summary of the Status Questionable register.
Preset	32767
Min	0
Max	32767
Status Bits/OPC dependencies	Sequential command
Initial S/W Revision	Prior to A.02.00

### Questionable Frequency Event Query

This query returns the decimal value of the sum of the bits in the Questionable Frequency Event register.

**NOTE**

The register requires that the associated PTR or NTR filters be set before a condition register bit can set a bit in the event register. The data in this register is latched until it is queried. Once queried, the register is cleared.

Mode	All
<b>Remote Command</b>	:STATus:QUEStionable:FREQuency[:EVENT]?
<b>Example</b>	STAT:QUES:FREQ?
Preset	0
Status Bits/OPC dependencies	Sequential command
Initial S/W Revision	Prior to A.02.00

### Questionable Frequency Negative Transition

This command determines which bits in the Questionable Frequency Condition register will set the corresponding bit in the Questionable Frequency Event register when the condition register bit has a negative transition (1 to 0). The variable <integer> is the sum of the decimal values of the bits that you want to enable.

Mode	All
------	-----

<b>Remote Command</b>	:STATus:QUESTionable:FREQuency:NTRansition <integer> :STATus:QUESTionable:FREQuency:NTRansition?
<b>Example</b>	STAT:QUES:FREQ:NTR 2 Frequency Reference 'regained lock' will be reported to the Frequency Summary of the Status Questionable register.
Preset	0
Min	0
Max	32767
Status Bits/OPC dependencies	Sequential command
Initial S/W Revision	Prior to A.02.00

### Questionable Frequency Positive Transition

This command determines which bits in the Questionable Frequency Condition register will set the corresponding bit in the Questionable Frequency Event register when the condition register bit has a positive transition (0 to 1). The variable <integer> is the sum of the decimal values of the bits that you want to enable.

Mode	All
<b>Remote Command</b>	:STATus:QUESTionable:FREQuency:PTRansition <integer> :STATus:QUESTionable:FREQuency:PTRansition?
<b>Example</b>	STAT:QUES:FREQ:PTR 2 Frequency Reference 'became unlocked' will be reported to the Frequency Summary of the Status Questionable register.
Preset	32767
Min	0
Max	32767
Status Bits/OPC dependencies	Sequential command
Initial S/W Revision	Prior to A.02.00

### Questionable Integrity Register

["Questionable Integrity Condition " on page 94](#)

["Questionable Integrity Enable " on page 95](#)

["Questionable Integrity Event Query " on page 95](#)

["Questionable Integrity Negative Transition " on page 96](#)

["Questionable Integrity Positive Transition " on page 96](#)

### Questionable Integrity Condition

This query returns the decimal value of the sum of the bits in the Questionable Integrity Condition register.

**NOTE**

The data in this register is continuously updated and reflects the current conditions.

Mode	All
<b>Remote Command</b>	:STATus:QUESTionable:INTEgrity:CONDition?
<b>Example</b>	STAT:QUES:INT:COND?
Preset	0
Status Bits/OPC dependencies	Sequential command
Initial S/W Revision	Prior to A.02.00

### Questionable Integrity Enable

This command determines which bits in the Questionable Integrity Condition Register will set bits in the Questionable Integrity Event register, which also sets the Integrity Summary bit (bit 9) in the Questionable Register. The variable <integer> is the sum of the decimal values of the bits you want to enable.

Mode	All
<b>Remote Command</b>	:STATus:QUESTionable:INTEgrity:ENABle <integer> :STATus:QUESTionable:INTEgrity:ENABle?
<b>Example</b>	STAT:QUES:INT:ENAB 8 Measurement Uncalibrated Summary will be reported to the Integrity Summary of the Status Questionable register.
Preset	32767
Min	0
Max	32767
Status Bits/OPC dependencies	Sequential command
Initial S/W Revision	Prior to A.02.00

### Questionable Integrity Event Query

This query returns the decimal value of the sum of the bits in the Questionable Integrity Event register.

**NOTE**

The register requires that the associated PTR or NTR filters be set before a condition register bit can set a bit in the event register. The data in this register is latched until it is queried. Once queried, the register is cleared.

Mode	All
<b>Remote Command</b>	:STATus:QUESTionable:INTEgrity[:EVENT]?
<b>Example</b>	STAT:QUES:INT?
Preset	0
Status Bits/OPC dependencies	Sequential command

---

Initial S/W Revision	Prior to A.02.00
----------------------	------------------

---

### Questionable Integrity Negative Transition

This command determines which bits in the Questionable Integrity Condition register will set the corresponding bit in the Questionable Integrity Event register when the condition register bit has a negative transition (1 to 0)

The variable <integer> is the sum of the decimal values of the bits that you want to enable.

---

Mode	All
<b>Remote Command</b>	:STATus:QUEStionable:INTEgrity:NTRansition <integer> :STATus:QUEStionable:INTEgrity:NTRansition?
<b>Example</b>	STAT:QUES:INT:NTR 8 Measurement 'regained calibration' Summary will be reported to the Integrity Summary of the Status Questionable register.
Preset	0
Min	0
Max	32767
Status Bits/OPC dependencies	Sequential command
Initial S/W Revision	Prior to A.02.00

---

### Questionable Integrity Positive Transition

This command determines which bits in the Questionable Integrity Condition register will set the corresponding bit in the Questionable Integrity Event register when the condition register bit has a positive transition (0 to 1). The variable <integer> is the sum of the decimal values of the bits that you want to enable.

---

Mode	All
<b>Remote Command</b>	:STATus:QUEStionable:INTEgrity:PTRansition <integer> :STATus:QUEStionable:INTEgrity:PTRansition?
<b>Example</b>	STAT:QUES:INT:PTR 8 Measurement 'became uncalibrated' Summary will be reported to the Integrity Summary of the Status Questionable register.
Preset	32767
Min	0
Max	32767
Status Bits/OPC dependencies	Sequential command
Initial S/W Revision	Prior to A.02.00

---

## Questionable Integrity Signal Register

"Questionable Integrity Signal Condition" on page 97

"Questionable Integrity Signal Enable" on page 97

"Questionable Integrity Signal Event Query" on page 98

"Questionable Integrity Signal Negative Transition" on page 98

"Questionable Integrity Signal Positive Transition" on page 98

### Questionable Integrity Signal Condition

This query returns the decimal value of the sum of the bits in the Questionable Integrity Signal Condition register.

**NOTE**

The data in this register is continuously updated and reflects the current conditions.

Mode	All
<b>Remote Command</b>	:STATus:QUESTionable:INTEgrity:SIGNal:CONDition?
<b>Example</b>	STAT:QUES:INT:SIGN:COND?
Preset	0
Status Bits/OPC dependencies	Sequential command
Initial S/W Revision	Prior to A.02.00

### Questionable Integrity Signal Enable

This command determines which bits in the Questionable Integrity Signal Condition Register will set bits in the Questionable Integrity Signal Event register, which also sets the Integrity Summary bit (bit 9) in the Questionable Register. The variable <integer> is the sum of the decimal values of the bits you want to enable.

Mode	All
<b>Remote Command</b>	:STATus:QUESTionable:INTEgrity:SIGNal:ENABle <integer> :STATus:QUESTionable:INTEgrity:SIGNal:ENABle?
<b>Example</b>	STAT:QUES:INT:SIGN:ENAB 4 Burst Not Found will be reported to the Integrity Summary of the Status Questionable register.
Preset	32767
Min	0
Max	32767
Status Bits/OPC dependencies	Sequential command
Initial S/W Revision	Prior to A.02.00

### Questionable Integrity Signal Event Query

This query returns the decimal value of the sum of the bits in the Questionable Integrity Signal Event register.

**NOTE**

The register requires that the associated PTR or NTR filters be set before a condition register bit can set a bit in the event register. The data in this register is latched until it is queried. Once queried, the register is cleared.

Mode	All
<b>Remote Command</b>	:STATus:QUESTionable:INTEgrity:SIGNal[:EVENT]?
<b>Example</b>	STAT:QUES:INT:SIGN?
Preset	0
Status Bits/OPC dependencies	Sequential command
Initial S/W Revision	Prior to A.02.00

### Questionable Integrity Signal Negative Transition

This command determines which bits in the Questionable Integrity Signal Condition register will set the corresponding bit in the Questionable Integrity Signal Event register when the condition register bit has a negative transition (1 to 0). The variable <integer> is the sum of the decimal values of the bits that you want to enable.

Mode	All
<b>Remote Command</b>	:STATus:QUESTionable:INTEgrity:SIGNal:NTRansition <integer> :STATus:QUESTionable:INTEgrity:SIGNal:NTRansition?
<b>Example</b>	STAT:QUES:INT:SIGN:NTR 4 Burst found will be reported to the Integrity Summary of the Status Questionable register.
Preset	0
Min	0
Max	32767
Status Bits/OPC dependencies	Sequential command
Initial S/W Revision	Prior to A.02.00

### Questionable Integrity Signal Positive Transition

This command determines which bits in the Questionable Integrity Signal Condition register will set the corresponding bit in the Questionable Integrity Signal Event register when the condition register bit has a positive transition (0 to 1). The variable <integer> is the sum of the decimal values of the bits that you want to enable.

Mode	All
<b>Remote Command</b>	:STATus:QUEStionable:INTEgrity:SIGNal:PTRansition <integer> :STATus:QUEStionable:INTEgrity:SIGNal:PTRansition?
<b>Example</b>	STAT:QUES:INT:SIGN:PTR 4 Burst not found will be reported to the Integrity Summary of the Status Questionable register.
Preset	32767
Min	0
Max	32767
Status Bits/OPC dependencies	Sequential command
Initial S/W Revision	Prior to A.02.00

### Questionable Integrity Uncalibrated Register

"Questionable Integrity Uncalibrated Condition " on page 99

"Questionable Integrity Uncalibrated Enable " on page 99

"Questionable Integrity Uncalibrated Event Query " on page 100

"Questionable Integrity Uncalibrated Negative Transition " on page 100

"Questionable Integrity Uncalibrated Positive Transition " on page 101

### Questionable Integrity Uncalibrated Condition

This query returns the decimal value of the sum of the bits in the Questionable Integrity Uncalibrated Condition register.

**NOTE** The data in this register is continuously updated and reflects the current conditions.

Mode	All
<b>Remote Command</b>	:STATus:QUEStionable:INTEgrity:UNCalibrated:CONDition?
<b>Example</b>	STAT:QUES:INT:UNC:COND?
Preset	0
Status Bits/OPC dependencies	Sequential command
Initial S/W Revision	Prior to A.02.00

### Questionable Integrity Uncalibrated Enable

This command determines which bits in the Questionable Integrity Uncalibrated Condition Register will set bits in the Questionable Integrity Uncalibrated Event register, which also sets the Data Uncalibrated Summary bit (bit 3) in the Questionable Integrity Register. The variable <integer> is the sum of the decimal values of the bits you want to enable.

Mode	All
<b>Remote Command</b>	:STATus:QUEStionable:INTEgrity:UNCalibrated:ENABle :STATus:QUEStionable:INTEgrity:UNCalibrated:ENABle?
<b>Example</b>	STAT:QUES:INT:UNC:ENAB 1 Oversweep (Meas Uncal) will be reported to the Integrity Summary of the Status Questionable register.
Preset	32767
Min	0
Max	32767
Status Bits/OPC dependencies	Sequential command
Initial S/W Revision	Prior to A.02.00

### Questionable Integrity Uncalibrated Event Query

This query returns the decimal value of the sum of the bits in the Questionable Integrity Uncalibrated Event register.

**NOTE**

The register requires that the associated PTR or NTR filters be set before a condition register bit can set a bit in the event register. The data in this register is latched until it is queried. Once queried, the register is cleared.

Mode	All
<b>Remote Command</b>	:STATus:QUEStionable:INTEgrity:UNCalibrated[:EVENT]?
<b>Example</b>	STAT:QUES:INT:UNC?
Preset	0
Status Bits/OPC dependencies	Sequential command
Initial S/W Revision	Prior to A.02.00

### Questionable Integrity Uncalibrated Negative Transition

This command determines which bits in the Questionable Integrity Uncalibrated Condition register will set the corresponding bit in the Questionable Integrity Uncalibrated Event register when the condition register bit has a negative transition (1 to 0). The variable <integer> is the sum of the decimal values of the bits that you want to enable.

Mode	All
<b>Remote Command</b>	:STATus:QUEStionable:INTEgrity:UNCalibrated:NTRansition <integer> :STATus:QUEStionable:INTEgrity:UNCalibrated:NTRansition?
<b>Example</b>	STAT:QUES:INT:UNC:NTR 1 Oversweep cleared will be reported to the Integrity Summary of the Status Questionable register.



Preset	0
Min	0
Max	32767
Status Bits/OPC dependencies	Sequential command
Initial S/W Revision	Prior to A.02.00

### Questionable Integrity Uncalibrated Positive Transition

This command determines which bits in the Questionable Integrity Uncalibrated Condition register will set the corresponding bit in the Questionable Integrity Uncalibrated Event register when the condition register bit has a positive transition (0 to 1). The variable <integer> is the sum of the decimal values of the bits that you want to enable.

Mode	All
<b>Remote Command</b>	:STATus:QUEStionable:INTEgrity:UNCalibrated:PTRansition <integer> :STATus:QUEStionable:INTEgrity:UNCalibrated:PTRansition?
<b>Example</b>	STAT:QUES:INT:UNC:PTR 1 Oversweep (Meas Uncal) occurred will be reported to the Integrity Summary of the Status Questionable register.
Preset	32767
Min	0
Max	32767
Status Bits/OPC dependencies	Sequential command
Initial S/W Revision	Prior to A.02.00

### Questionable Power Register

"Questionable Power Condition " on page 101

"Questionable Power Enable " on page 102

"Questionable Power Event Query " on page 102

"Questionable Power Negative Transition " on page 103

"Questionable Power Positive Transition " on page 103

### Questionable Power Condition

This query returns the decimal value of the sum of the bits in the Questionable Power Condition register.

#### NOTE

The data in this register is continuously updated and reflects the current conditions.

Mode	All
<b>Remote Command</b>	:STATus:QUESTionable:POWer:CONDition?
<b>Example</b>	STAT:QUES:POW:COND?
Preset	0
Status Bits/OPC dependencies	Sequential command
Initial S/W Revision	Prior to A.02.00

### Questionable Power Enable

This command determines which bits in the Questionable Power Condition Register will set bits in the Questionable Power Event register, which also sets the Power Summary bit (bit 3) in the Questionable Register. The variable <integer> is the sum of the decimal values of the bits you want to enable.

Mode	All
<b>Remote Command</b>	:STATus:QUESTionable:POWer:ENABle <integer> :STATus:QUESTionable:POWer:ENABle?
<b>Example</b>	STAT:QUES:POW:ENAB 32 50 MHz Input Pwr too High for Cal will be reported to the Power Summary of the Status Questionable register.
Preset	32767
Min	0
Max	32767
Status Bits/OPC dependencies	Sequential command
Initial S/W Revision	Prior to A.02.00

### Questionable Power Event Query

This query returns the decimal value of the sum of the bits in the Questionable Power Event register.

**NOTE**

The register requires that the associated PTR or NTR filters be set before a condition register bit can set a bit in the event register. The data in this register is latched until it is queried. Once queried, the register is cleared.

Mode	All
<b>Remote Command</b>	:STATus:QUESTionable:POWer[:EVENT]?
<b>Example</b>	STAT:QUES:POW?
Preset	0
Status Bits/OPC dependencies	Sequential command
Initial S/W Revision	Prior to A.02.00

### Questionable Power Negative Transition

This command determines which bits in the Questionable Power Condition register will set the corresponding bit in the Questionable Power Event register when the condition register bit has a negative transition (1 to 0). The variable <integer> is the sum of the decimal values of the bits that you want to enable.

Mode	All
<b>Remote Command</b>	:STATus:QUESTionable:POWer:NTRansition <integer> :STATus:QUESTionable:POWer:NTRansition?
<b>Example</b>	STAT:QUES:POW:NTR 32 50 MHz Input Power became OK for Cal will be reported to the Power Summary of the Status Questionable register.
Preset	0
Min	0
Max	32767
Status Bits/OPC dependencies	Sequential command
Initial S/W Revision	Prior to A.02.00

### Questionable Power Positive Transition

This command determines which bits in the Questionable Power Condition register will set the corresponding bit in the Questionable Power Event register when the condition register bit has a positive transition (0 to 1). The variable <integer> is the sum of the decimal values of the bits that you want to enable.

Mode	All
<b>Remote Command</b>	:STATus:QUESTionable:POWer:PTRansition <integer> :STATus:QUESTionable:POWer:PTRansition?>
<b>Example</b>	STAT:QUES:POW:PTR 32 50 MHz Input Power became too high for Cal will be reported to the Power Summary of the Status Questionable register.
Preset	32767
Min	0
Max	32767
Status Bits/OPC dependencies	Sequential command
Initial S/W Revision	Prior to A.02.00

### Questionable Temperature Register

"Questionable Temperature Condition" on page 104

"Questionable Temperature Enable" on page 104

"Questionable Temperature Event Query" on page 104

"Questionable Temperature Negative Transition" on page 105

"Questionable Temperature Positive Transition" on page 105

### Questionable Temperature Condition

This query returns the decimal value of the sum of the bits in the Questionable Temperature Condition register.

**NOTE**

The data in this register is continuously updated and reflects the current conditions.

Mode	All
<b>Remote Command</b>	:STATus:QUESTionable:TEMPerature:CONDition?
<b>Example</b>	STAT:QUES:TEMP:COND?
Preset	0
Status Bits/OPC dependencies	Sequential command
Initial S/W Revision	Prior to A.02.00

### Questionable Temperature Enable

This command determines which bits in the Questionable Temperature Condition Register will set bits in the Questionable Temperature Event register, which also sets the Temperature Summary bit (bit 4) in the Questionable Register. The variable <integer> is the sum of the decimal values of the bits you want to enable.

Mode	All
<b>Remote Command</b>	:STATus:QUESTionable:TEMPerature:ENABle <integer> :STATus:QUESTionable:TEMPerature:ENABle?
<b>Example</b>	STAT:QUES:TEMP:ENAB 1 Reference Oscillator Oven Cold will be reported to the Temperature Summary of the Status Questionable register.
Preset	32767
Min	0
Max	32767
Status Bits/OPC dependencies	Sequential command
Initial S/W Revision	Prior to A.02.00

### Questionable Temperature Event Query

This query returns the decimal value of the sum of the bits in the Questionable Temperature Event register.

**NOTE**

The register requires that the associated PTR or NTR filters be set before a condition register bit can set a bit in the event register. The data in this register is latched until it is queried. Once queried, the register is cleared

Mode	All
<b>Remote Command</b>	:STATus:QUEStionable:TEMPerature[:EVENT]?
<b>Example</b>	STAT:QUES:TEMP?
Preset	0
Status Bits/OPC dependencies	Sequential command
Initial S/W Revision	Prior to A.02.00

### Questionable Temperature Negative Transition

This command determines which bits in the Questionable Temperature Condition register will set the corresponding bit in the Questionable Temperature Event register when the condition register bit has a negative transition (1 to 0). The variable <integer> is the sum of the decimal values of the bits that you want to enable.

Mode	All
<b>Remote Command</b>	:STATus:QUEStionable:TEMPerature:NTRansition <integer> :STATus:QUEStionable:TEMPerature:NTRansition?
<b>Example</b>	STAT:QUES:TEMP:NTR 1 Reference Oscillator Oven not cold will be reported to the Temperature Summary of the Status Questionable register.
Preset	0
Min	0
Max	32767
Status Bits/OPC dependencies	Sequential command
Initial S/W Revision	Prior to A.02.00

### Questionable Temperature Positive Transition

This command determines which bits in the Questionable Temperature Condition register will set the corresponding bit in the Questionable Temperature Event register when the condition register bit has a positive transition (0 to 1). The variable <integer> is the sum of the decimal values of the bits that you want to enable.

Mode	All
<b>Remote Command</b>	:STATus:QUEStionable:TEMPerature:PTRansition <integer> :STATus:QUEStionable:TEMPerature:PTRansition?
<b>Example</b>	STAT:QUES:TEMP:PTR 1 Reference Oscillator Oven became cold will be reported to the

---

	Temperature Summary of the Status Questionable register.
Preset	32767
Min	0
Max	32767
Status Bits/OPC dependencies	Sequential command
Initial S/W Revision	Prior to A.02.00

---

## IEEE 488.2 Common Commands

The instrument supports the following subset of IEEE 488.2 Common Commands, as defined in Chapter 10 of [IEEE Standard 488.2–1992](#). As indicated in the detailed descriptions, some of these commands correspond directly to instrument front-panel key functionality, while others are available only as remote commands.

Command	Description
*CAL?	Align Now "All (Daily use)" on page 208
*CLS	"Clear Status " on page 109
*ESE	"Standard Event Status Enable " on page 110
*ESE?	
*ESR?	"Standard Event Status Register Query " on page 110
*IDN?	"Identification Query " on page 111
*OPC	"Operation Complete " on page 111
*OPC?	
*OPT?	"Query Instrument Options " on page 112
*RCL	"Recall Instrument State " on page 113
*RST	"*RST (Remote Command Only)" on page 113
*SAV	"Save Instrument State " on page 114
*SRE	"Service Request Enable " on page 114
*SRE?	
*STB?	"Status Byte Query " on page 114
*TRG	"Trigger " on page 115
*TST?	"Self Test Query " on page 115
*WAI	"Wait-to-Continue " on page 115

### All (Daily use)

Immediately executes an alignment of all subsystems which includes both the source and the analyzer in the TRX module. The "All" alignment is sufficient to maintain specified performance, provided that (1) the TRX's internal temperature has not drifted more than +/-5 degree C since the previous alignment, and (2) no more than 8 hours have elapsed since the previous "All" alignment., and (3) no more than 1 week has elapsed since these three alignments have all been run: IF, RF, and Source, and (4) a 45 minute warm-up period between power-up of the TRX and invoking the "All" alignment. The instrument stops any measurement currently underway, performs the alignment, then restarts the measurement from the beginning (similar to pressing the Restart key).

If an interfering user signal is present at the RF Input, the alignment is performed on all subsystems except the RF. After completion, the Error Condition message "Align skipped: 50 MHz interference" or "Align

skipped: 4.8 GHz interference” is generated. In addition the Error Condition message “Align Now, RF required” is generated, and bits 11 and 12 are set in the Status Questionable Calibration register.

The query form of the remote commands (:CALibration[:ALL]? or \*CAL?) invokes the alignment of all subsystems and returns a success or failure value. An interfering user signal is not grounds for failure; if the alignment was able to succeed on all portions but unable to align the RF because of an interfering signal, the resultant will be the success value.

Successful completion of Align Now, All will clear the “Align Now, All required” Error Condition, and clear bit 14 in the Status Questionable Calibration register. It will also begin the elapsed time counter for Last Align Now, All Time, and capture the Last Align Now, All Temperature.

If the Align RF subsystem succeeded in aligning (no interfering signal present), the elapsed time counter begins for Last Align Now, RF Time, and the temperature is captured for the Last Align Now, RF Temperature. In addition the Error Conditions “Align skipped: 50 MHz interference” and “Align skipped: 4.8 GHz interference” are cleared, the Error Condition “Align Now, RF required” is cleared, and bits 11 and 12 are cleared in the Status Questionable Calibration register

Align Now, All can be interrupted by pressing the Cancel (ESC) front-panel key or remotely with Device Clear followed by the :ABORt SCPI command. When this occurs the Error Condition message “Align Now, All required” is generated, and bit 14 is set in the Status Questionable Condition register. This is because new alignment data may be employed for an individual subsystem, but not a cohesive set of data for all subsystems.

In many cases, you might find it more convenient to change alignments to Normal, instead of executing Align Now, All. When the Auto Align process transitions to Normal, the analyzer will immediately start to update only the alignments that have expired, thus efficiently restoring the alignment process.

**NOTE**

In EXM/M9420A, Source ARB play will be turned off and the source states will not be restored after Align Now, All.

<b>Key Path</b>	System, Alignments, Align Now
<b>Mode</b>	All
<b>Remote Command</b>	:CALibration[:ALL] :CALibration[:ALL]?
<b>Example</b>	:CAL
<b>Notes</b>	:CALibration[:ALL]? returns 0 if successful :CALibration[:ALL]? returns 1 if failed :CALibration[:ALL]? is the same as *CAL? While Align Now, All is performing the alignment, bit 0 in the Status Operation register is set. Completion, or termination, will clear bit 0 in the Status Operation register. This command is sequential; it must complete before further SCPI commands are processed. Interrupting the alignment from remote is accomplished by invoking Device Clear followed by the :ABORt command. Successful completion will clear bit 14 in the Status Questionable Calibration register. An interfering user signal is not grounds for failure of Align Now, All. However, bits 11 and 12 are set in the Status Questionable Calibration register to indicate Align Now, RF is required.



	An interfering user supplied signal will result in the instrument requiring an Align Now, RF with the interfering signal removed.
Couplings	Initializes the time for the Last Align Now, All Time. Records the temperature for the Last Align Now, All Temperature. If Align RF component succeeded, initializes the time for the Last Align Now, RF Time. If Align RF component succeeded, records the temperature for the Last Align Now, RF Temperature.
Status Bits/OPC dependencies	Bits 11, 12, or 14 may be set in the Status Questionable Calibration register.
Initial S/W Revision	Prior to A.02.00

Mode	All
Remote Command	*CAL?
Example	*CAL?
Notes	*CAL? returns 0 if successful *CAL? returns 1 if failed :CALibration[:ALL]? is the same as *CAL? See additional remarks described with :CALibration[:ALL]? Everything about :CALibration[:ALL]? is synonymous with *CAL? including all conditions, status register bits, and couplings
Initial S/W Revision	Prior to A.02.00

Mode	All
Remote Command	:CALibration[:ALL]:NPENDING
Example	CAL:NPEN
Notes	:CALibration[:ALL]:NPENDING is the same as :CALibration[:ALL] including all conditions, status register bits, except this scpi command does not BLOCK the scpi session, so the user should use status register bits to query if the calibration is successfully completed or not. Typical usage is: 1) :CALibration:ALL:NPENDING (Start a calibration) 2) :STATUS:OPERation:CONDition? (Check if the calibration is completed or not, If bit 0 is set, then the system is doing calibration, the user should repeat this scpi query until the bit is cleared ) 3):STATUS:QUESTionable:CALibration:CONDition? (Check if there are any errors/failures in previous calibration procedure
Initial S/W Revision	X.14.20

## Clear Status

Clears the status byte register. It does this by emptying the error queue and clearing all bits in all of the event registers. The status byte register summarizes the states of the other registers. It is also responsible

for generating service requests.

Key Path	No equivalent key. Related key System, Show Errors, Clear Error Queue
Remote Command	*CLS
Example	*CLS Clears the error queue and the Status Byte Register.
Notes	For related commands, see the SYSTem:ERRor[:NEXT]? command. See also the STATus:PRESet command and all commands in the STATus subsystem.
Status Bits/OPC dependencies	Resets all bits in all event registers to 0, which resets all the status byte register bits to 0 also.
Backwards Compatibility Notes	In general the status bits used in the X-Series status system will be backwards compatible with ESA and PSA. However, note that all conditions will generate events that go into the event log, and some will also generate status bits.
Initial S/W Revision	Prior to A.02.00

### Standard Event Status Enable

Selects the desired bits from the standard event status enable register. This register monitors I/O errors and synchronization conditions such as operation complete, request control, query error, device dependent error, status execution error, command error, and power on. The selected bits are OR'd to become a summary bit (bit 5) in the byte register which can be queried.

The query returns the state of the standard event status enable register.

Key Path	No equivalent key. Related key System, Show Errors, Clear Error Queue
Remote Command	*ESE <integer> *ESE?
Example	*ESE 36 Enables the Standard Event Status Register to monitor query and command errors (bits 2 and 5). *ESE? Returns a 36 indicating that the query and command status bits are enabled.
Notes	For related commands, see the STATus subsystem and SYSTem:ERRor[:NEXT]? commands.
Preset	255
State Saved	Not saved in state.
Min	0
Max	255
Status Bits/OPC dependencies	Event Enable Register of the Standard Event Status Register.
Initial S/W Revision	Prior to A.02.00

### Standard Event Status Register Query

Queries and clears the standard event status event register. (This is a destructive read.) The value returned is a hexadecimal number that reflects the current state (0/1) of all the bits in the register.

<b>Remote Command</b>	*ESR?
<b>Example</b>	*ESR? Returns a 1 if there is either a query or command error, otherwise it returns a zero.
<b>Notes</b>	For related commands, see the STATus subsystem commands.
<b>Preset</b>	0
<b>Min</b>	0
<b>Max</b>	255
<b>Status Bits/OPC dependencies</b>	Standard Event Status Register (bits 0 – 7).
<b>Initial S/W Revision</b>	Prior to A.02.00

## Identification Query

Returns a string of instrument identification information. The string will contain the model number, serial number, and firmware revision.

The response is organized into four fields separated by commas. The field definitions are as follows:

- Manufacturer
- Model
- Serial number
- Firmware version

<b>Key Path</b>	No equivalent key. See related key System, Show System.
<b>Remote Command</b>	*IDN?
<b>Example</b>	*IDN? Returns instrument identification information, such as: Keysight Technologies, M9420A, US01020004, M.16.30
<b>Initial S/W Revision</b>	Prior to A.02.00
<b>Modified at S/W Revision</b>	x.14.50

## Operation Complete

The \*OPC command sets bit 0 in the standard event status register (SER) to “1” when pending operations have finished, that is when all overlapped commands are complete. It does not hold off subsequent operations. You can determine when the overlapped commands have completed either by polling the OPC bit in SER, or by setting up the status system such that a service request (SRQ) is asserted when the OPC bit is set.

The \*OPC? query returns a “1” after all the current overlapped commands are complete. So it holds off subsequent commands until the “1” is returned, then the program continues. This query can be used to synchronize events of other instruments on the external bus.

<b>Remote Command</b>	*OPC *OPC?
<b>Example</b>	INIT:CONT 0 Selects single sweeping. INIT:IMM Initiates a sweep. *OPC? Holds off any further commands until the sweep is complete.
<b>Status Bits/OPC dependencies</b>	Not global to all remote ports or front panel. *OPC only considers operation that was initiated on the same port as the *OPC command was issued from. *OPC is an overlapped command, but *OPC? is sequential.
<b>Backwards Compatibility Notes</b>	<ol style="list-style-type: none"> <li>1. The ESA/PSA/VSA products do not meet all the requirements for the *OPC command specified by IEEE 488.2. This is corrected for X-Series. This will sometimes cause behavior that is not backward compatible, but it will work as customers expect.</li> <li>2. Commands such as, *OPC/*OPC?/*WAI/*RST used to be global. They considered front panel operation in conjunction with the GPIB functionality. Now they are evaluated on a per channel basis. That is, the various rear panel remote ports and the front panel i/o are all considered separately. Only the functionality initiated on the port where the *OPC was sent, is considered for its operation.</li> <li>3. *OPC used to hold off until the operation bits were cleared. Now it holds off until all overlapping commands are completed. Also, earlier instruments did not wait for completion of all processes, only the ones identified here (in the STATus:OPERation register):            Calibrating: monitored by PSA, ESA, VSA (E4406A)            Sweeping: monitored by PSA, ESA, VSA (E4406A)            Waiting for Trigger: monitored by PSA, ESA, VSA (E4406A)            Measuring: monitored by PSA and ESA (but not in all Modes).            Paused: monitored by VSA (E4406A).            Printing: monitored by VSA (E4406A).            Mass memory busy: monitored by VSA (E4406A).</li> </ol>
<b>Initial S/W Revision</b>	Prior to A.02.00

## Query Instrument Options

Returns a string of all the installed instrument options. It is a comma separated list with quotes, such as: "503,P03,PFR".

To be IEEE compliant, this command should return an arbitrary ascii variable that would not begin and end with quotes. But the quotes are needed to be backward compatible with previous SA products and software. So, the actual implementation will use arbitrary ascii. But quotes will be sent as the first and last ascii characters that are sent with the comma-separated option list.

<b>Remote Command</b>	*OPT?
<b>Initial S/W Revision</b>	Prior to A.02.00

## Recall Instrument State

This command recalls the instrument state from the specified instrument memory register.

- If the state being loaded has a newer firmware revision than the revision of the instrument, no state is recalled and an error is reported
- If the state being loaded has an equal firmware revision than the revision of the instrument, the state will be loaded.
- If the state being loaded has an older firmware revision than the revision of the instrument, the instrument will only load the parts of the state that apply to the older revision.

<b>Remote Command</b>	*RCL <register #>
<b>Example</b>	*RCL 7 Recalls the instrument state that is currently stored in register 7.
Notes	Registers 0 through 6 are accessible from the front panel in menu keys for Recall Registers.
Min	0
Max	127
Status Bits/OPC dependencies	The command is sequential.
Initial S/W Revision	Prior to A.02.00

## \*RST (Remote Command Only)

\*RST is equivalent to :SYST:PRESet:INIT:CONT OFF, which is a Mode Preset in the Single measurement state. This remote command is preferred over Mode Preset remote command - :SYST:PRESet, as optimal remote programming occurs with the instrument in the single measurement state.

<b>Remote Command</b>	*RST
<b>Example</b>	*RST
Notes	Sequential Clears all pending OPC bits and the Status Byte is set to 0.
Couplings	A *RST will cause the currently running measurement to be aborted and cause the default measurement to be active. *RST gets the mode to a consistent state with all of the default couplings set.
Backwards Compatibility Notes	In legacy analyzers *RST did not set the analyzer to Single, but in the X-Series it does, for compliance with the IEEE 488.2 specification. In the X-Series, *RST does not do a *CLS (clear the status bits and the error queue). In legacy analyzers, *RST used to do the equivalent of SYSTem:PRESet, *CLS and INITiate:CONTinuous OFF. But to be 488.2 compliant, *RST in the X-Series does not do a *CLS.
Initial S/W Revision	Prior to A.02.00

## Save Instrument State

This command saves the current instrument state and mode to the specified instrument memory register.

<b>Remote Command</b>	*SAV <register #>
<b>Example</b>	*SAV 9 Saves the instrument state in register 9.
Notes	Registers 0 through 6 are accessible from the front panel in menu keys for Save Registers.
Min	0
Max	127
Status Bits/OPC dependencies	The command is sequential.
Initial S/W Revision	Prior to A.02.00

## Service Request Enable

This command enables the desired bits of the service request enable register.

The query returns the value of the register, indicating which bits are currently enabled.

<b>Remote Command</b>	*SRE <integer> *SRE?
<b>Example</b>	*SRE 22 Enables bits 1, 2, and 4 in the service request enable register.
Notes	For related commands, see the STATus subsystem and SYSTem:ERRor[:NEXT]? commands.
Preset	0
Min	0
Max	255
Status Bits/OPC dependencies	Service Request Enable Register (all bits, 0 - 7).
Initial S/W Revision	Prior to A.02.00

## Status Byte Query

Returns the value of the status byte register without erasing its contents.

<b>Remote Command</b>	*STB?
<b>Example</b>	*STB? Returns a decimal value for the bits in the status byte register. For example, if a 16 is returned, it indicates that bit 5 is set and one of the conditions monitored in the standard event status register is set.
Notes	See related command *CLS.
Status Bits/OPC dependencies	Status Byte Register (all bits, 0 - 7).
Initial S/W Revision	Prior to A.02.00

## Trigger

This command triggers the instrument. Use the :TRIGger[:SEquence]:SOURce command to select the trigger source.

Key Path	No equivalent key. See related keys Single and Restart.
<b>Remote Command</b>	*TRG
<b>Example</b>	*TRG Triggers the instrument to take a sweep or start a measurement, depending on the current instrument settings.
Notes	See related command :INITiate:IMMEDIATE.
Initial S/W Revision	Prior to A.02.00

## Self Test Query

This query performs the internal self-test routines and returns a number indicating the success of the testing. A zero is returned if the test is successful, 1 if it fails.

<b>Remote Command</b>	*TST?
<b>Example</b>	*TST? Runs the self-test routines and returns 0=passed, 1=some part failed.
Initial S/W Revision	Prior to A.02.00

## Wait-to-Continue

This command causes the instrument to wait until all overlapped commands are completed before executing any additional commands. There is no query form for the command.

<b>Remote Command</b>	*WAI
<b>Example</b>	INIT:CONT OFF; INIT;*WAI Sets the instrument to single sweep. Starts a sweep and waits for its completion.
Status Bits/OPC dependencies	Not global to all remote ports or front panel. *OPC only considers operation that was initiated on the same port as the *OPC command was issued from.
Initial S/W Revision	Prior to A.02.00





## 4 Input/Output Functions

## Input/Output

The Input/Output features are common across multiple Modes and Measurements. These common features are described in this section. See the Measurement description for information on features that are unique.

The Input/Output key accesses the keys that control the Input/Output parameters of the instrument. In general, these are functions associated with external connections to the analyzer, either to the inputs or the outputs. Since these connections tend to be fairly stable within a given setup, in general, the input/output settings do not change when you Preset the analyzer.

Other functions related to the input/output connections, but which tend to change on a measurement by measurement basis, can be found under the Trigger and AMPTD Y Scale keys. In addition, some of the digital I/O bus configurations can be found under the System key.

**NOTE**

The functions in the Input/Output menu are "global" (common) to all Modes (applications). But individual Input/Output functions only appear in a Mode if they apply to that Mode. Functions that apply to a Mode but not to all measurements in the Mode may be grayed-out in some measurements.

["Input/Output variables - Preset behavior" on page 119](#)

The Input Port selection is the first menu under the Input/Output key:

Key Path	Front-panel key
<b>Remote Command</b>	<code>[ :SENSe ] :FEED RF   AIQ   EMIXer</code> <code>[ :SENSe ] :FEED?</code>
<b>Example</b>	<code>:FEED RF</code> <code>:FEED?</code>
<b>Couplings</b>	The <code>[ :SENSe ] :FEED RF</code> command turns the calibrator OFF
<b>Preset</b>	This setting is unaffected by a Preset or power cycle. It survives a Mode Preset and mode changes. It is set to RF on a "Restore Input/Output Defaults" or "Restore System Defaults->All"
<b>State Saved</b>	Saved in instrument state
<b>Backwards Compatibility SCPI</b>	<code>[ :SENSe ] :FEED AREFERENCE</code> In the PSA the calibrator was one of the inputs and selected using the AREF parameter to the same <code>:FEED</code> command that switched the inputs. In the X-Series it is controlled in a separate menu and overrides the input selection. For code compatibility the <code>[ :SENSe ] :FEED AREFERENCE</code> command is provided, and is aliased to <code>[ :SENSe ] :FEED :AREF REF50</code> , which causes the input to be switched to the 50 MHz calibrator. The <code>[ :SENSe ] :FEED RF</code> command switches the input back to the RF port and turns the calibrator OFF, thus providing full compatibility with the PSA calibrator function. Note that after sending this, the query <code>[ :SENSe ] :FEED?</code> will NOT return "AREF" but instead the currently selected input.
<b>Backwards Compatibility SCPI</b>	<code>[ :SENSe ] :FEED IQ   IONLy   QONLy</code> <code>[ :SENSe ] :FEED?</code> The parameters <code>IQ   IONLy   QONLy</code> are supported for backwards compatibility with the E44406A. <code>[ :SENSe ] :FEED IQ</code> aliases to <code>[ :SENSe ] :FEED :IQ :TYPE IQ</code> <code>[ :SENSe ] :FEED IONLy</code> aliases to <code>[ :SENSe ] :FEED :IQ :TYPE IONLy</code>

	<p>[;SENSe]:FEED QONLy aliases to [;SENSe]:FEED:IQ:TYPE QONLy</p> <p>The query [;SENSe]:FEED? will always returns AIQ whatever the type of legacy parameters IQ   IONLy   QONLy has been used.</p>
Backwards Compatibility Notes	<p>Most of the settings in the X-Series Input/Output system, including External Gain, Amplitude Corrections settings and data, etc., are shared by all modes and are not changed by a mode switch. Furthermore, most variables in the Input/Output system key are not affected by Mode Preset. Both of these behaviors represent a departure from legacy behavior.</p> <p>In the X-Series. Input/Output settings are reset by using the "Restore Input/Output Defaults" function. They can also be reset to their default values through the System-&gt;Restore System Defaults-&gt; In/Out Config key or through the System -&gt;Restore System Defaults -&gt; All key (and corresponding SCPI).</p> <p>While this matches most use cases better, it does create some code compatibility issues. For example, Amplitude Corrections are no longer turned off by a Mode Preset, but instead by using the "Restore Input/Output Defaults" key/SCPI.</p> <p>Although Input/Output settings are not part of each Mode's State, they are saved in the Save State files, so that all of the instrument settings can be recalled with Recall State, as in legacy instruments.</p>
Initial S/W Revision	Prior to A.02.00
<b>Remote Command</b>	<p>:INPut:MIXer EXTernal INTernal</p> <p>:INPut:MIXer?</p>
<b>Example</b>	<p>INP:MIX INT</p> <p>INP:MIX?</p>
Notes	<p>In legacy analyzers you choose between the Internal mixer or an External Mixer. In the X-Series, the External Mixer is one of the choices for the Input and is selected using the FEED command (:SENSe:FEED EXTMIxer).</p> <p>For compatibility, the INPut:MIXer EXTernal INTernal legacy command is mapped as follows:</p> <ol style="list-style-type: none"> <li>1. When INPut:MIXer EXTernal is received, SENSe:FEED EMIXer is executed.</li> <li>2. When INPut:MIXer INTernal is received, SENSe:FEED RF is executed.</li> <li>3. When INPut:MIXer? is received, the response will be INT if any input other than the external mixer is selected and EXT if the external mixer is selected</li> </ol>
Preset	INT
Backwards Compatibility Notes	<p>PSA supports the following SCPI Command :</p> <p>:INPut:MIXer:TYPE PRESelected UNPReselect</p> <p>:INPut:MIXer:TYPE?</p> <p>PXA does not support the :INPut:MIXer:TYPE command.</p>
Initial S/W Revision	A.08.01

## Input/Output variables - Preset behavior

Virtually all the input/output settings are NOT a part of mode preset. They can be set to their default value

by one of the three ways:

- by using the Restore Input/Output Defaults key on the first page of the input/output menu,
- by using the System->Restore System Defaults->Input/Output Settings or,
- by using the System -> Restore System Defaults->All. Also, they survive a Preset and a Power cycle.

A very few of the Input/Output settings do respond to a Mode Preset; for example, if the Calibrator is on it turns off on a Preset, and if DC coupling is in effect it switches to AC on a Preset. These exceptions are made in the interest of reliability and usability, which overrides the need for absolute consistency. Exceptions are noted in the SCPI table for the excepted functions.

## RF Input

Selects the front-panel RF input port to be the analyzer signal input. If RF is already selected, pressing this key accesses the RF input setup functions.

<b>Key Path</b>	<b>Input/Output</b>
<b>Example</b>	[:SENSe]:FEED RF
<b>Couplings</b>	The act of connecting the U7227A USB Preamplifier to one of the analyzer's USB ports will cause the Input to automatically switch to the RF Input. If the RF Calibrator is on, it is turned off. Subsequently disconnecting the USB Preamp from USB does not change the Input selection nor restore the previous selection.
<b>Readback</b>	The RF input port, RF coupling, and current input impedance settings appear on this key as: "XX, YY, ZZ" where XX is RF, RF2, RFIO1, RFIO2, depending on what input is selected (only appears on analyzers with multiple RF inputs) YY is AC or DC ZZ is 50Ω or 75Ω
<b>Initial S/W Revision</b>	Prior to A.02.00
<b>Modified at S/W Revision</b>	A.14.00

## Input Z Correction

Sets the input impedance for unit conversions. This affects the results when the y-axis unit is voltage or current units (dBmV, dBμV, dBμA, V, A), but not when it is power units (dBm, W). The impedance you select is for computational purposes only, since the actual impedance is set by internal hardware to 50 ohms. Setting the computational input impedance to 75 ohms is useful when using a 75 ohm to 50 ohm adapter to measure a 75 ohm device on an analyzer with a 50 ohm input impedance.

There are a variety of ways to make 50 to 75 ohm transitions, such as impedance transformers or minimum loss pads. The choice of the solution that is best for your measurement situation requires balancing the amount of loss that you can tolerate with the amount of measurement frequency range that you need. If you are using one of these pads/adaptors with the Input Z Corr function, you might also want to use the Ext Gain key. This function is used to set a correction value to compensate for the gain (loss) through your pad. This correction factor is applied to the displayed measurement values.

Key Path	Input/Output, RF Input
Remote Command	<code>[ :SENSe ] :CORRection:IMPedance [ :INPut ] [ :MAGNitude ] 50   75</code> <code>[ :SENSe ] :CORRection:IMPedance [ :INPut ] [ :MAGNitude ] ?</code>
Example	CORR:IMP 75 sets the input impedance correction to 75 ohms. CORR:IMP?
Preset	This is unaffected by a Preset but is set to 50 ohms on a "Restore Input/Output Defaults" or "Restore System Defaults->All" Some instruments/options may have 75 ohms available.
State Saved	Saved in instrument state
Readback	50 Ω or 75 Ω. Current setting reads back to the RF key.
Initial S/W Revision	Prior to A.02.00

## RF Input Port

Specifies the RF input port used. The RF Input Port key only appears on units with multiple inputs, and lets you switch between the two inputs.

Switching from the RF input port to one of the RFIO ports, on units that have them, changes the receiver performance of the instrument.

Key Path	Input/Output, RF Input
Remote Command	<code>[ :SENSe ] :FEED:RF:PORT [ :INPut ] RFIN   RFIN2   RFIO1   RFIO2   RFIO3   RFIO4   RFHD   RFFD</code> <code>[ :SENSe ] :FEED:RF:PORT [ :INPut ] ?</code>
Example	:FEED:RF:PORT RFIN
Dependencies	This key only appears in models that support multiple inputs. If the SCPI command is sent with unsupported parameters in any other model, an error is generated, -221.1900, "Settings conflict;option not installed" When any input is selected in a measurement that does not support it, the "No result; Meas invalid with this input" error condition occurs, and the measurement returns invalid data when queried. RFHD and RFFD are only available on M9420A, option "HDX" is required to enable RFHD port and option "FDX" is required to enable RFFD port.
Preset	This is unaffected by Mode Preset but is set to RF on a "Restore Input/Output Defaults" or "Restore System Defaults -> All"
State Saved	Saved in instrument state
Readback	The current RF Input Port selected is read back to this key
Backwards Compatibility SCPI	<code>INPut&lt;1   2&gt;:TYPE INPUT1   INPUT2</code> <code>INPut&lt;1   2&gt;:TYPE?</code> Included for R&S ESU compatibility. In the MXE, the INPUT1 parameter is aliased to RFIN and the INPUT2 parameter is aliased to RFIN2

Initial S/W Revision	A.05.01
Modified at S/W Revision	A.14.00

### RF Input

Specifies using the main RF port for the current measurement

Key Path	Input/Output, RF Input, RF Input Port
Example	:FEED:RF:PORT RFIN
ReadBack	RF Input
Initial S/W Revision	A.05.01
Modified at S/W Revision	A.14.00

### External Gain

Compensates for gain or loss in the measurement system outside the spectrum analyzer. The External Gain is subtracted from the amplitude readout (or the loss is added to the amplitude readout). So, the displayed signal level represents the signal level at the output of the device-under-test, which can be the input of an external device that provides gain or loss.

Entering an External Gain value does not affect the Reference Level, therefore the trace position on screen changes, as do all of the values represented by the trace data. Thus, the values of exported trace data, queried trace data, marker amplitudes, trace data used in calculations such as N dB points, trace math, peak threshold, etc., are all affected by External Gain. Changing the External Gain, even on a trace that is not updating, will immediately change all of the above, without new data needing to be taken.

**NOTE**

Changing the External Gain causes the analyzer to immediately stop the current sweep and prepare to begin a new sweep. The data will not change until the trace data updates because the offset is applied to the data as it is taken. If a trace is exported with a nonzero External Gain, the exported data will contain the trace data with the offset applied.

In the Spectrum Analyzer mode, a Preamp is the common external device providing gain or loss. In a measurement application mode like GSM or W-CDMA, the gain or loss could be from a BTS (Base Transceiver Station) or an MS (Mobile Station). So in the Spectrum Analyzer mode MS and BTS would be grayed out and the only choice would be Ext Preamp. Similarly in some of the digital communications applications, Ext Preamp will be grayed out and you would have a choice of MS or BTS.

Key Path	Input/Output
Couplings	The Ext Preamp, MS, and BS keys may be grayed out depending on which measurement is currently selected. If any of the grayed out keys are pressed, or the equivalent SCPI command is sent, an advisory message is generated.
Readback	1-of-N selection   [variable]
Initial S/W Revision	Prior to A.02.00

## Ext Preamp

This function is similar to the reference level offset function. Both affect the displayed signal level. Ref Lvl Offset is a mathematical offset only, no analyzer configuration is affected. Ext Preamp gain is used when determining the auto-coupled value of the Attenuator. The External Gain value and the Maximum Mixer Level settings are both part of the automatic setting equation for the RF attenuation setting. (10 dB of Attenuation is added for every 10 dB of External Gain.)

Note that the Ref Lvl Offset and Maximum Mixer Level are described in the Amplitude section. They are reset by the instrument Preset. The External Preamp Gain is reset by the "Restore Input/Output Defaults" or "Restore System Defaults->All functions. . The External Gain is subtracted from the amplitude readout so that the displayed signal level represents the signal level at the output of the device-under-test, which is the input of the external device that is providing gain or loss.

["More Information" on page 123](#)

Key Path	Input/Output, External Gain
Remote Command	<code>[ :SENSe ] :CORRection:SA[:RF]:GAIN &lt;rel_ampl&gt;</code> <code>[ :SENSe ] :CORRection:SA[:RF]:GAIN?</code>
Example	CORR:SA:GAIN 10 sets the Ext Gain value to 10 dB CORR:SA:GAIN -10 sets the Ext Gain value to -10 dB (that is, an attenuation of 10 dB)
Notes	Does not auto return.
Dependencies	The reference level limits are determined in part by the External Gain/Atten, Max Mixer Level, and RF Atten. This key is grayed out in Modes that do not support External Gain
Preset	This is unaffected by Preset but is set to 0 dB on a "Restore Input/Output Defaults" or "Restore System Defaults->All"
State Saved	Saved in instrument state
Min	-120 dB
Max	120 dB
Readback	Preamp Gain, <Ext Gain value> dB
Backwards Compatibility SCPI	<code>[ :SENSe ] :CORRection:OFFSet[:MAGNitude]</code> The legacy "Ext Preamp Gain" key is now called "Ext Gain" and the sub-menu has choices of Ext Preamp   MS   BTS for backwards compatibility.
Initial S/W Revision	Prior to A.02.00
Modified at S/W Revision	A.14.00

## More Information

The U7227A USB Preamplifier is an accessory for the X-Series Signal Analyzer that provides gain externally, and whose gain settings are automatically loaded into the analyzer over USB whenever it is connected to one of the analyzer's USB ports.

While the USB Preamplifier is plugged into one of the analyzer's USB ports, the analyzer will consider it to be in the signal path of the RF Input and will apply the calibration data from the USB Preamp to measurements taken at the RF Input (on 2 input boxes, it will be considered to be in the signal path of RF Input 1; it is not supported for RF Input 2).

The USB Preamplifier contains its own cal data. This includes a noise trace suitable for use with NFE, for those models which support NFE. The act of connecting the Preamp to USB will cause the cal data to be downloaded from the preamp. When this happens an informational message is provided saying "Cal data loaded from USB Preamp". The analyzer will then automatically apply the calibration factors loaded from the Preamp in any measurement that supports the USB Preamp.

The External Preamp Gain setting may still be used, even though it is not required for the USB Preamp (since the USB Preamp supplies its own gain data to the analyzer which is applied automatically). Connecting the USB Preamp does not change the External Preamp Gain setting, however unless you have another gain or attenuation element in the signal path, the appropriate setting for External Preamp Gain is 0 dB.

Overload detection and reporting will apply when the USB preamplifier is connected to USB. The USB Preamplifier has its own overload detector which reports overloads to the instrument over USB. This generates an error condition, "Input Overload;USB Preamp."

If, while the USB Preamp is connected to USB, a measurement is selected that does not support the USB preamplifier, the "No result; Meas invalid with Preamp" error condition is generated.

## MS

Sets an external gain/attenuation value for MS (Mobile Station) tests.

<b>Key Path</b>	Input/Output, External Gain
<b>Remote Command</b>	<code>[ :SENSE ] :CORRection:MS[:RF]:GAIN &lt;rel_ampl&gt;</code> <code>[ :SENSe ] :CORRection:MS[:RF]:GAIN?</code>
<b>Example</b>	<code>CORR:MS:GAIN 10</code> sets the Ext Gain value to 10 dB <code>CORR:MS:GAIN -10</code> sets the Ext Gain value to -10 dB (that is, a loss of 10 dB.)
<b>Notes</b>	Does not auto return.
<b>Dependencies</b>	The reference level limits are determined in part by the External Gain, Max Mixer Level, RF Atten This key is grayed out in modes that do not support MS.
<b>Preset</b>	This is unaffected by a Preset but is set to 0 dB on a "Restore Input/Output Defaults" or "Restore System Defaults->All"
<b>State Saved</b>	Saved in instrument state.
<b>Min</b>	-100 dB
<b>Max</b>	100 dB
<b>Readback</b>	MS, <Ext Gain value> dB
<b>Initial S/W Revision</b>	Prior to A.02.00

<b>Remote Command</b>	<code>[ :SENSe ] :CORRection:MS[:RF]:LOSS &lt;rel_ampl&gt;</code>
-----------------------	-------------------------------------------------------------------



	<code>[ :SENSe ] :CORRection:MS [ :RF ] :LOSS?</code>
<b>Example</b>	<code>CORR:MS:LOSS 10</code> sets the Ext Gain value to -10 dB, and subsequently querying <code>:LOSS</code> will give 10 dB <code>CORR:MS:LOSS -10</code> sets the Ext Gain value to 10 dB, and subsequently querying <code>:LOSS</code> will give -10 dB
Notes	A positive value of <code>&lt;rel_ampl&gt;</code> in the above command means a loss and a negative value indicates a gain. Anytime <code>:LOSS</code> is set it sets <code>:GAIN</code> to the negative value of the parameter sent. Anytime <code>:LOSS</code> is queried it gives the negative of <code>:GAIN</code>
Preset	This is unaffected by a Preset but is set to 0 dB on a "Restore Input/Output Defaults" or "Restore System Defaults->All"
Min	100 dB
Max	-100 dB
Initial S/W Revision	Prior to A.02.00

## BTS

Sets an external attenuation value for BTS (Base Transceiver Station) tests.

Key Path	Input/Output, External Gain
<b>Remote Command</b>	<code>[ :SENSe ] :CORRection:BTS [ :RF ] :GAIN &lt;rel_ampl&gt;</code> <code>[ :SENSe ] :CORRection:BTS [ :RF ] :GAIN?</code>
<b>Example</b>	<code>CORR:BTS:GAIN 10</code> sets the Ext Gain value to 10 dB <code>CORR:BTS:GAIN -10</code> sets the Ext Gain value to -10 dB (that is, a loss of 10 dB.)
Notes	Does not auto return.
Dependencies	The reference level limits are determined in part by the External Gain, Max Mixer Level, RF Atten This key is grayed out in modes that do not support BTS.
Preset	This is unaffected by a Preset but is set to 0 dB on a "Restore Input/Output Defaults" or "Restore System Defaults->All"
State Saved	Saved in instrument state.
Min	-100 dB
Max	100 dB
Readback	BTS, <code>&lt;Ext Gain value&gt;</code> dB
Initial S/W Revision	Prior to A.02.00

<b>Remote Command</b>	<code>[ :SENSe ] :CORRection:BTS [ :RF ] :LOSS &lt;rel_ampl&gt;</code> <code>[ :SENSe ] :CORRection:BTS [ :RF ] :LOSS?</code>
<b>Example</b>	<code>CORR:BTS:LOSS 10</code> sets the Ext Gain value to -10 dB, and subsequently querying <code>:LOSS</code> will give 10

	dB CORR:BTS:LOSS -10 sets the Ext Gain value to 10 dB, and subsequently querying :LOSS will give -10 dB
Notes	A positive value of <rel_ampl> in the above command means a loss and a negative value indicates a gain. Anytime :LOSS is set it sets :GAIN to the negative value of the parameter sent. Anytime :LOSS is queried it gives the negative of :GAIN
Preset	This is unaffected by a Preset but is set to 0 dB on a "Restore Input/Output Defaults" or "Restore System Defaults->All"
Min	100 dB
Max	-100 dB
Initial S/W Revision	Prior to A.02.00

## Restore Input/Output Defaults

This selection causes the group of settings and data associated with the Input/Output key to be a reset to their default values. In addition, when a Source is installed, licensed and selected, Restore Input/Output defaults will initiate a Source Preset.

This level of Restore System Defaults does not affect any other system settings or mode settings and does not cause a mode switch. All the features described in this section are reset using this key, including Input Corrections and Data (described in the Corrections section).

Key Path	Input/Output
Example	:SYST:DEF INP presets all the Input/Output variables to their factory default values.
Notes	Refer to the Utility Functions for information about Restore System Defaults and the complete description of the :SYSTEM:DEfault INPut: command.
Initial S/W Revision	Prior to A.02.00

## Freq Ref In

Specifies the frequency reference as being the internal reference at the rear panel input labeled EXT REF IN, a 1 pulse per second signal at the EXT REF IN input,, external reference or sensing the presence of a signal at the EXT REF IN input.

When the frequency reference is set to internal, the internal 10 MHz reference is used even if an external reference is connected.

When the frequency reference is set to external, the instrument will use the external reference. However, if there is no external signal present, or it is not within the proper amplitude range, a condition error message is generated. When the external signal becomes valid, the error is cleared.

When the frequency reference is set to Pulse, the instrument expects a 1 pulse per second signal at the EXT REF IN input. The instrument uses this signal to adjust the frequency of the internal reference.

If Sense is selected, the instrument checks whether a signal is present at the external reference connector. If it senses a signal within 5 ppm of the External Ref Freq (as set on the External Ref Freq softkey), it will automatically switch to the external reference. If it senses a 1 pulse per second signal, it enters Pulse mode, wherein the signal is used to adjust the internal reference. When no signal is present, it automatically switches to the internal reference. No message is generated as the reference switches between pulse, external and internal. The monitoring of the external reference occurs approximately on 1 millisecond intervals, and never occurs in the middle of a measurement acquisition, only at the end of the measurement (end of the request).

If for any reason the instrument's frequency reference is not able to obtain lock, Status bit 1 in the Questionable Frequency register will be true and a condition error message is generated. When lock is regained, Status bit 1 in the Questionable Frequency register will be cleared and the condition error will be cleared.

If an external frequency reference is being used, you must enter the frequency of the external reference if it is not exactly 10 MHz. The External Ref Freq key is provided for this purpose.

**NOTE:**

A common frequency reference module serves all instrument instances, but only one instance of the software application can change the reference input type (INT or EXT or SENSE). The software application allowed to change the reference input is called the controlling instance; by default, the left most instrument instance is the controlling instance. This can be changed in the config file "E66XXModules.config" located under the folder E:\Agilent\Instrument. For the non-controlling instance (s) the reference input types (in SCPI commands, and in the Virtual Front Panel menus ) are blanked and unavailable for use.

On M9420A module, there is no internal frequency reference. To work correctly, a 100MHz external frequency reference signal is needed to connect to the front panel of the module. The default Freq Ref In setting is "External" and it cannot be set to any other types.

Key Path	Input/Output
<b>Remote Command</b>	<code>[ :SENSe ] :ROSCillator :SOURCE :TYPE INTernal   EXTernal   SENSe   PULSe</code> <code>[ :SENSe ] :ROSCillator :SOURCE :TYPE ?</code>
Dependencies	The PULSe parameter, and support of the 1 pps signal at the EXT REF IN input, are not available in firmware prior to A.13.00. They are also not available in some model numbers. If not available, the Pulse key will be blank, and sending the PULSe parameter via SCPI will generate an error. M9420A is only support EXTernal type.
Preset	This is unaffected by a Preset but is set to EXTernal for M9420A or SENSe for other models on a "Restore Input/Output Defaults" or "Restore System Defaults->All".
State Saved	Saved in instrument state.
Status Bits/OPC dependencies	STATus:QUESTionable:FREQuency bit 1 set if unlocked. Note: The status bit is not set for non-controlling instances. To determine if the frequency reference is unlocked, the controlling instance must be queried.
Backwards Compatibility Notes	Freq Ref In was not saved in state in the legacy instruments. It is a part of state in the X-Series.
Initial S/W Revision	Prior to A.02.00
Modified at S/W Revision	A.14.00

<b>Remote Command</b>	<code>[ :SENSe ] :ROSCillator :SOURce ?</code>
Notes	<p>The query <code>[SENSe]:ROSCillator:SOURce?</code> returns the current switch setting. This means:</p> <ol style="list-style-type: none"> <li>1. If it was set to <code>SENSe</code> but there is no external reference nor 1 pps signal so the instrument is actually using the internal reference, then this query returns <code>INTernal</code> and not <code>SENSe</code>.</li> <li>2. If it was set to <code>SENSe</code> and there is an external reference present, the query returns <code>EXTernal</code> and not <code>SENSe</code>.</li> <li>3. If it was set to <code>SENSe</code> and there is a 1 pps signal present, the query returns <code>PULSe</code> and not <code>SENSe</code>.</li> <li>4. If it was set to <code>EXTernal</code>, then the query returns "EXTernal"</li> <li>5. If it was set to <code>INTernal</code>, then the query returns "INTernal".</li> <li>6. If it was set to <code>PULSe</code>, then the query returns "PULSe"</li> </ol> <p>Note: The SCPI query always returns "INTernal" for non-controlling instances. M9420A is only supported <code>EXTernal</code> type.</p>
Preset	<p>All other models: <code>SENSe</code> M9420A: <code>EXTernal</code></p>
Backwards Compatibility Notes	<p>The query <code>[ :SENSe ] :ROSCillator :SOURce ?</code> was a query-only command in ESA which always returned whichever reference the instrument was using. The instrument automatically switched to the ext ref if it was present.</p> <p>In PSA (which had no sensing) the command <code>[ :SENSe ] :ROSCillator :SOURce</code> set the reference (INT or EXT), so again its query returned the actual routing.</p> <p>Thus the query form of this command is 100% backwards compatible with both instruments.</p>
Initial S/W Revision	Prior to A.02.00

<b>Remote Command</b>	<code>[ :SENSe ] :ROSCillator :SOURce INTernal   EXTernal</code>
Notes	<p>For PSA compatibility the command form is provided and is directly mapped to <code>[ :SENSe ] :ROSCillator :SOURce :TYPE</code></p> <p>Note: The SCPI command does nothing for non-controlling instances.</p>
Initial S/W Revision	Prior to A.02.00

## External

The external reference is used.

Key Path	Input/Output, Freq Ref In
<b>Example</b>	<code>:ROSC:SOUR:TYPE EXT</code>
Readback	External
Initial S/W Revision	Prior to A.02.00

## Ext Ref Freq

This key tells the analyzer the frequency of the external reference. When the external reference is in use (either because the reference has been switched to External or because the Reference has been switched to Sense and there is a valid external reference present) this information is used by the analyzer to determine the internal settings needed to lock to that particular external reference signal.

For the instrument to stay locked, the value entered must be within 5 ppm of the actual external reference frequency. So it is important to get it close, or you risk an unlock condition.

Note that this value only affects the instrument's ability to lock. It does not affect any calculations or measurement results. See "Freq Offset" in the Frequency section for information on how to offset frequency values.

Key Path	Input/Output, Freq Ref In
Remote Command	[ :SENSe ] :ROSCillator:EXTernal:FREQuency <freq> [ :SENSe ] :ROSCillator:EXTernal:FREQuency?
Example	ROSC:EXT:FREQ 20 MHz sets the external reference frequency to 20 MHz, but does not select the external reference. ROSC:SOUR:TYPE EXT selects the external reference.
Dependencies	Still available with Internal or Pulse selected, to allow setup for when External is in use. However, the setting has no effect if the Internal Reference is in use (Freq Ref In set to Internal, Pulse, or SENSE:INT or SENSE:PULSE).
Preset	This is unaffected by a Preset but is set to 10 MHz on a "Restore Input/Output Defaults" or "Restore System Defaults->All"
Min	M9420A:100 MHz
Max	M9420A:100 MHz
Default Unit	Hz
Initial S/W Revision	Prior to A.02.00
Modified at S/W Revision	A.14.00

## RF Output & Test Set Config

The RF Output & Test Set Config key allows you to set the RF Output Port and multipoint adapter unit which is connected to the instrument by USB for download of calibration data and additional control.

This menu also allows you to set Trigger Config which is used to set the input/output type of the 4 Bi-directional Trigger ports.

Key Path	Input/Output
Preset	All settings under this key are returned to their default state when Restore Input/Output Defaults is pressed.
State Saved	Saved in State
Initial S/W Revision	A.09.49

## RF Output

Specifies the RF Output Port used.

Switching from the RF Output port to one of the RFIO ports changes the transmitter performance of the instrument.

Key Path	Input/Output, RF Output & Test Set Config
Remote Command	[ :SENSe ] :FEED:RF:PORT:OUTPut RFOut   RFIO1   RFIO2   GPSout   GNSSout   RFIO3   RFIO4   RFHD   RFFD  [ :SENSe ] :FEED:RF:PORT:OUTPut?
Example	:FEED:RF:PORT:OUTP RFIO1
Dependencies	RFHD and RFFD are only available on M9420A, option "HDX" is required to enable RFHD port and option "FDX" is required to enable RFFD port.
Preset	This is unaffected by Mode Preset but is set to RFOut on a "Restore Input/Output Defaults" or "Restore System Defaults -> All"
State Saved	Saved in State
Readback	The current RF Output Port selected is read back to this key
Initial S/W Revision	A.05.01
Modified at S/W Revision	A.14.00

## RF Output

The RF port that will be used for the current output.

Key Path	Input/Output, RF Output & Test Set Config, RF Output
Example	:FEED:RF:PORT:OUTP RFO
ReadBack	RF Output
Initial S/W Revision	A.05.01
Modified at S/W Revision	A.14.00

## Output Config

Accesses keys that configure various output settings, like the frequency reference output, trigger output and analog output.

Key Path	Input/Output
Backwards Compatibility Notes	In ESA there was not a user interface to enable the Video Output (Analog Output), Trigger Output, or Gate Output. In the X-Series each of these physical connectors requires configuration, thus the user interface has been added for X-Series, along with the potential for an output you think is always on to be switched off.
Initial S/W Revision	Prior to A.02.00

## Trig Out

Select the type of output signal that will be output from the Trig 1 Out, or Trig 2 Out connectors.

Key Path	Input/Output, Output Config
<b>Remote Command</b>	:TRIGger TRIGger1 TRIGger2[:SEquence]:OUTPut HSWP   MEASuring   MAIN   GATE   GTRigger   OEven   SPOint   SSweep   SSETtled   S1Marker   S2Marker   S3Marker   S4Marker   OFF  :TRIGger TRIGger1 TRIGger2[:SEquence]:OUTPut?
<b>Example</b>	TRIG:OUTP HSWP TRIG2:OUTP GATE
<b>Dependencies</b>	The second Trigger output (Trig 2 Out) does not appear in all models; in models that do not support it, the Trig 2 Out key is blanked, and sending the SCPI command for this output generates an error, "Hardware missing; Not available for this model number" In models that do not support the Trigger 2 output, this error is returned if trying to set Trig 2 Out and a query of Trig 2 Out returns OFF.
<b>Preset</b>	Trigger 1: Sweeping (HSWP) Trigger 2: Gate  This is unaffected by a Preset but is preset to the above values on a "Restore Input/Output Defaults" or "Restore System Defaults->All"
<b>State Saved</b>	Saved in instrument state
<b>Initial S/W Revision</b>	Prior to A.02.00

## Polarity

Sets the output to the Trig 1 Out, or Trig 2 Out, connector to trigger on either the positive or negative polarity.

Key Path	Input/Output, Output Config, Trig 1/2 Output
<b>Remote Command</b>	:TRIGger TRIGger1 TRIGger2[:SEquence]:OUTPut:POLarity POSitive   NEGative  :TRIGger TRIGger1 TRIGger2[:SEquence]:OUTPut:POLarity?
<b>Example</b>	TRIG1:OUTP:POL POS
<b>Preset</b>	This is unaffected by a Preset but is set to POSitive on a "Restore Input/Output Defaults" or "Restore System Defaults->All"
<b>State Saved</b>	Saved in instrument state
<b>Initial S/W Revision</b>	Prior to A.02.00

## Off

Selects no signal to be output to the Trig 1 Out, or Trig 2 Out, connector.

Key Path	Input/Output, Output Config, Trig 1/2 Output
<b>Example</b>	TRIG1:OUTP OFF
Readback	Off
Initial S/W Revision	Prior to A.02.00

### Sweeping (HSWP)

Selects the Sweeping Trigger signal to be output to the Trig 1 Out, or Trig 2 Out, connector when a measurement is made. This signal has historically been known as "HSWP" (High = Sweeping), and is 5 V TTL level with 50 ohm output impedance.

Key Path	Input/Output, Output Config, Trig 1/2 Output
<b>Example</b>	TRIG1:OUTP HSWP
Readback	Sweeping
Initial S/W Revision	Prior to A.02.00

### Measuring

Selects the Measuring trigger signal to be output to the Trig 1 Out, or Trig 2 Out, connector. This signal is true while the Measuring status bit is true.

Key Path	Input/Output, Output Config, Trig 1/2 Output
<b>Example</b>	TRIG1:OUTP MEAS
Readback	Measuring
Initial S/W Revision	Prior to A.02.00

### Main Trigger

Selects the current instrument trigger signal to be output to the Trig 1 Out, or Trig 2 Out, connector.

Key Path	Input/Output, Output Config, Trig 1/2 Output
<b>Example</b>	TRIG1:OUTP MAIN
Readback	Main Trigger
Initial S/W Revision	Prior to A.02.00

### Gate Trigger

Selects the gate trigger signal to be output to the Trig 1 Out, or Trig 2 Out, connector. This is the source of the gate timing, not the actual gate signal.



Key Path	Input/Output, Output Config, Trig 1/2 Output
<b>Example</b>	TRIG1:OUTP GTR
Readback	Gate Trigger
Initial S/W Revision	Prior to A.02.00

## Gate

Selects the gate signal to be output to the Trig 1 Out, or Trig 2 Out, connector. The gate signal has been delayed and its length determined by delay and length settings. When the polarity is positive, a high on the Trig 1 Out, or Trig 2 Out, represents the time the gate is configured to pass the signal.

Key Path	Input/Output, Output Config, Trig 1/2 Output
<b>Example</b>	TRIG1:OUTP GATE
Readback	Gate
Initial S/W Revision	Prior to A.02.00

## Odd/Even Trace Point

Selects either the odd or even trace points as the signal to be output to the Trig 1 Out, or Trig 2 Out, connector when performing swept spectrum analysis. When the polarity is positive, this output goes high during the time the analyzer is sweeping past the first point (Point 0) and every other following trace point. The opposite is true if the polarity is negative.

Key Path	Input/Output, Output Config, Trig 1/2 Output
<b>Example</b>	TRIG1:OUTP OEV
Readback	Odd/Even
Initial S/W Revision	Prior to A.02.00

## Trig Out

Select the type of output signal that will be output from the Trig 1 Out, or Trig 2 Out connectors.

Key Path	Input/Output, Output Config
<b>Remote Command</b>	:TRIGger TRIGger1 TRIGger2[:SEquence]:OUTPut HSWP   MEASuring   MAIN   GATE   GTRigger   OEVEN   SPOint   SSWeep   SSEtTled   S1Marker   S2Marker   S3Marker   S4Marker   OFF  :TRIGger TRIGger1 TRIGger2[:SEquence]:OUTPut?
<b>Example</b>	TRIG:OUTP HSWP TRIG2:OUTP GATE
Dependencies	The second Trigger output (Trig 2 Out) does not appear in all models; in models that do not support it, the Trig 2 Out key is blanked, and sending the SCPI command for this output generates an error,

	"Hardware missing; Not available for this model number" In models that do not support the Trigger 2 output, this error is returned if trying to set Trig 2 Out and a query of Trig 2 Out returns OFF.
Preset	Trigger 1: Sweeping (HSWP) Trigger 2: Gate This is unaffected by a Preset but is preset to the above values on a "Restore Input/Output Defaults" or "Restore System Defaults->All"
State Saved	Saved in instrument state
Initial S/W Revision	Prior to A.02.00

### Off

Selects no signal to be output to the Trig 1 Out, or Trig 2 Out, connector.

Key Path	Input/Output, Output Config, Trig 1/2 Output
<b>Example</b>	TRIG1:OUTP OFF
Readback	Off
Initial S/W Revision	Prior to A.02.00

### Source Marker 1

Trigger output at marker 1 in current playing Waveform file.

Key Path	Input/Output, Output Config, Trig 1/2 Output
Example	:TRIG1:OUTP S1M
ReadBack	Marker 1
Initial S/W Revision	A.05.01

### Source Marker 2

Trigger output at marker 2 in current playing Waveform file.

Key Path	Input/Output, Output Config, Trig 1/2 Output
Example	:TRIG1:OUTP S2M
ReadBack	Marker 2
Initial S/W Revision	A.05.01

### Source Marker 3

Trigger output at marker 3 in current playing Waveform file.

Key Path	Input/Output, Output Config, Trig 1/2 Output
Example	:TRIG1:OUTP S3M
ReadBack	Marker 3
Initial S/W Revision	A.05.01

### Source Marker 4

Trigger output at marker 4 in current playing Waveform file.

Key Path	Input/Output, Output Config, Trig 1/2 Output
Example	:TRIG1:OUTP S4M
ReadBack	Marker 4
Initial S/W Revision	A.05.01

### Analog Out

This menu lets you control which signal is fed to the “Analog Out” connector on the analyzer rear panel.

See ["More Information" on page 135](#)

Key Path	Input/Output, Output Config
<b>Remote Command</b>	:OUTPut:ANALog OFF   SVIDeo   LOGVIdeo   LINVIdeo   DAUDio :OUTPut:ANALog?
Example	OUTP:ANAL SVIDeo ! causes the analog output type to be Screen Video
Preset	This is unaffected by Preset but is set to DAUDio on a "Restore Input/Output Defaults" or "Restore System Defaults->All
Preset	OFF
State Saved	Saved in Input/Output State
Readback line	1-of-N selection [variable]
Backwards Compatibility Notes	Prior to A.04.00, OFF was the default functionality except when in the Analog Demod application or with Tune and Listen, in which case it was DAUDio, and there was no selection menu. So for backwards compatibility with earlier X-Series firmware versions, Auto (:OUTP:ANAL:AUTO ON) will duplicate the prior behavior.  The DNWB and SANalyzer parameters, which were legal in PSA but perform no function in the X-Series, are accepted without error.
Initial S/W Revision	A.04.00

### More Information

The table below gives the range for each output.

<b>Analog Out</b>	<b>Nominal Range exc. (10% overrange)</b>	<b>Scale Factor</b>	<b>Notes</b>
Off	0 V		
Screen Video	0 – 1 V open circuit	10%/division	8566 compatible
Log Video	0 – 1 V terminated	1/(192.66 dB/V)	dB referenced to mixer level, 1 V out for –10 dBm at the mixer.
Linear Video	0 – 1 V terminated	100%/V	Linear referenced to Ref Level, 1 V out for RF envelope at the Ref Level.
Demod Audio	(varies with analyzer setting)		

### Auto

Selects the Auto state for the Analog Output menu. In this state, the Analog Output will automatically be set to the most sensible setting for the current mode or measurement.

If you make a selection manually from the Analog Out menu, this selection will remain in force until you change it (or re-select Auto), even if you go to a mode or measurement for which the selected output does not apply.

<b>Key Path</b>	Input/Output, Output Config, Analog Out
<b>Remote Command</b>	OUTPut:ANALog:AUTO OFF ON 0 1 OUTPut:ANALog:AUTO?
<b>Example</b>	OUTP:ANAL:AUTO ON
<b>Preset</b>	ON
<b>State Saved</b>	Saved in Input/Output State
<b>Initial S/W Revision</b>	A.04.00

### Off

Turns off the analog output.

<b>Key Path</b>	Input/Output, Output Config, Analog Out
<b>Example</b>	OUTP:ANAL OFF ! causes the analog output to be off
<b>Readback Text</b>	Off
<b>Initial S/W Revision</b>	A.04.00

## LISN Control

Enables you to access LISN related functions. LISN control is only available with option LSN indicating that the LISN IO board is installed. This is a remote query command only.

### V-network (Remote Command Only)

Enables you to select the V-network that is controlled via the AUX IO port.

<b>Remote Command</b>	INPut [1]   2:LISN[:TYPE] FOURphase ESH2Z5  ENV216   OFF INPut [1]   2:LISN[:TYPE] ?
<b>Example</b>	:INP:LISN FOUR
<b>Notes</b>	FOURPhase and ESH2-Z5 R&S ESH2-Z5 (four phases and protective earth are controllable) ENV216 R&S ENV216 (two phases and highpass are controllable) OFF Remote control deactivated This query will return :- FOUR when ESH2-Z5 is selected.
<b>Preset</b>	Set to off on a "Restore Input/Output Defaults"
<b>State Saved</b>	Saved in instrument state
<b>Initial S/W Revision</b>	A.14.50

### Phase (Remote Command Only)

This command enables you to select the phase of the V-network that is used, which is controlled via the AUX IO port. The permissible selection depends on the selected V-network.

<b>Remote Command</b>	INPut [1]   2:LISN:PHASe L1 L2 L3 N INPut [1]   2:LISN:PHASe?
<b>Example</b>	:INP:LISN:PHAS L1
<b>Couplings</b>	L2, L3 keys are grayed out when ENV216 is selected. If the grayed out key is pressed, an advisory message is generated. If the equivalent SCPI command is sent, this same message is generated as part of a "-224, Illegal parameter value; must apply ESH2Z5 to make this phase available" warning.
<b>Preset</b>	Set to N on a "Restore Input/Output Defaults"
<b>State Saved</b>	Saved in instrument state
<b>Range</b>	Phase N Phase L1 Phase L2 Phase L3 Only one phase can be selected.
<b>Initial S/W Revision</b>	A.14.50

## 150 kHz Highpass (Remote Command Only)

Controls highpass setting on the V-network.

<b>Remote Command</b>	INPut [1]   2:LISN:FILTeR:HPAS[:STATe] ON OFF INPut [1]   2:LISN:FILTeR:HPAS[:STATe] ?
<b>Example</b>	:INP:LISN:FILT:HPAS ON
<b>Dependencies</b>	Only available for ENV216 V-network . This key is grayed out when a V-network that is not ENV216 is selected. If the grayed out key is pressed, an advisory message is generated. If the equivalent SCPI command is sent, this same message is generated as part of a “-221, Settings conflicts; LISN function not available” warning.
<b>Preset</b>	Set to off on a "Restore Input/Output Defaults"
<b>State Saved</b>	Saved in instrument state
<b>Range</b>	ON OFF
<b>Initial S/W Revision</b>	A.14.50

## Protective Earth (Remote Command Only)

Enables you to set the Protective Earth setting that is controlled via the AUX IO port.

<b>Remote Command</b>	INPut [1]   2:LISN:PEARth GROunded FLOating INPut [1]   2:LISN:PEARth?
<b>Example</b>	:INP:LISN:PEAR GRO
<b>Dependencies</b>	Only available for ESH2Z5. This key is grayed out when a v-network other than ESH2Z5 is selected. If the grayed out key is pressed, an advisory message is generated. If the equivalent SCPI command is sent, this same message is generated as part of a “-221, Settings conflict; LISN function not available” warning.
<b>Preset</b>	Set to GRO on a "Restore Input/Output Defaults"
<b>State Saved</b>	Saved in instrument state
<b>Range</b>	GRO FLO
<b>Initial S/W Revision</b>	A.14.50

## 5 Mode Functions

## Mode

The Mode key allows you to select the available measurement applications or “Modes”. Modes are a collection of measurement capabilities packaged together to provide an instrument personality that is specific to your measurement needs. Each application software product is ordered separately by Model Number and must be licensed to be available. Once an instrument mode is selected, only the commands that are valid for that mode can be executed.

**NOTE**

Key operation can be different between modes. The information displayed in Help is about the current mode.

To access Help for a different Mode you must first exit Help (by pressing the Cancel (Esc) key). Then select the desired mode and re-access Help.

For more information on Modes, preloading Modes, and memory requirements for Modes,

see ["More Information" on page 141](#)

Key Path	Front-panel key
<b>Remote Command</b>	:INSTrument[:SElect] SA   RTSA   SEQAN   EMI   BASIC   WCDMA   EDGE GSM   WIMAXOFDMA   VSA   PNOISE   NFIGure   ADEMOD   BTooth   TDSCDMA   CDMA2K   CDMA1XEV   LTE   LTE TDD   LTEAFDD   LTEATDD   MSR   DVB   DTMB   DCTV   ISDBT   CMMB   WLAN   CWLAN   CWIMAXOFDM   WIMAXFIXED   IDEN   RLC   SCPI LC   VSA89601  :INSTrument[:SElect]?
<b>Example</b>	:INST SA
<b>Notes</b>	The available parameters are dependent upon installed and licensed applications resident in the instrument. Parameters given here are an example, specific parameters are in the individual Application.  A list of the valid mode choices is returned with the INST:CAT? Query.
<b>Preset</b>	This is unaffected by a Preset but is set on a “Restore System Defaults->All” to: SEQAN
<b>State Saved</b>	Saved in instrument state
<b>Backwards Compatibility SCPI</b>	:INSTrument[:SElect] GSM provided for backwards compatibility. Mapped to EDGE GSM.
<b>Backwards Compatibility SCPI</b>	:INSTrument[:SElect] SANalyzer provided for ESU compatibility. When this command is received, the analyzer aliases it to the following: INST:SEL SCPI LC  This results in the analyzer being placed in SCPI Language Compatibility Mode, in order to emulate the ESU Spectrum Analyzer Mode.
<b>Backwards Compatibility SCPI</b>	:INSTrument[:SElect] RECeiver provided for ESU compatibility. When this command is received, the analyzer aliases it to the following: :INST:SEL EMI



	:CONF FSC
	This results in the analyzer being placed in the EMI Receiver Mode, running the Frequency Scan measurement, in order to emulate the ESU Receiver Mode.
Initial S/W Revision	Prior to A.02.00
Modified at S/W Revision	A.13.00

<b>Example</b>	:INST 'SA'
Notes	The query is not a quoted string. It is an enumeration as indicated in the Instrument Select table above.  The command must be sequential: i.e. continued parsing of commands cannot proceed until the instrument select is complete and the resultant SCPI trees are available.
<b>Backwards Compatibility SCPI</b>	:INSTrument[:SElect] 'SA'   'PNOISE'   'EDGE'   'GSM'   'BASIC'
Initial S/W Revision	Prior to A.02.00

## More Information

The Mode name appears on the banner after the word “Keysight” followed by the Measurement Title. For example, for the IQ Analyzer mode with the Complex Spectrum measurement running:

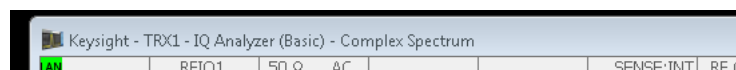

It is possible to specify the order in which the Modes appear in the Mode menu, using the Configure Applications utility (System, Power On, Configure Applications). It is also possible, using the same utility, to specify a subset of the available applications to load into memory at startup time, which can significantly decrease the startup time of the analyzer. During runtime, if an application that is not loaded into memory is selected (by either pressing that applications Mode key or sending that applications :INST:SEL command over SCPI), there will be a pause while the Application is loaded. During this pause a message box that says “Loading application, please wait...” is displayed.

Each application (Mode) that runs in the X-Series signal analyzers consumes virtual memory. The various applications consume varying amounts of virtual memory, and as more applications run, the memory consumption increases. Once an application is run, some of its memory remains allocated even when it is not running, and is not released until the analyzer program (xSA.exe) is shut down.

Keysight characterizes each Mode and assigns a memory usage quantity based on a conservative estimate. There is a limited amount of virtual memory available to applications (note that this is virtual memory and is independent of how much physical RAM is in the instrument). The instrument keeps track of how much memory is being used by all loaded applications – which includes those that preloaded at startup, and all of those that have been run since startup.

When you request a Mode that is not currently loaded, the instrument looks up the memory estimate for that Mode, and adds it to the residual total for all currently loaded Modes. If there is not enough virtual memory to load the Mode, a dialog box and menu will appear that gives you four options:

1. Close and restart the analyzer program without changing your configured preloads. This may free up enough memory to load the requested Mode, depending on your configured preloads
2. Clear out all preloads and close and restart the analyzer program with only the requested application preloaded, and with that application running. This choice is guaranteed to allow you to run the requested application; but you will lose your previously configured preloads. In addition, there may be little or no room for other applications, depending on the size of the requested application.
3. Bring up the Configure Applications utility in order to reconfigure the preloaded apps to make room for the applications you want to run (this will then require restarting the analyzer program with your new configuration). This is the recommended choice because it gives you full flexibility to select exactly what you want.
4. Exit the dialog box without doing anything, which means you will be unable to load the application you requested.

In each case except 4, this will cause the analyzer software to close, and you will lose all unsaved traces and results.

If you attempt to load a mode via SCPI that will exceed memory capacity, the Mode does not load and an error message is returned:

```
-225,"Out of memory;Insufficient resources to load Mode (mode name)"
```

where "mode name" is the SCPI parameter for the Mode in question, for example, SA for Spectrum Analyzer Mode.

### IQ Analyzer (Basic)

The IQ Analyzer Mode makes general purpose frequency domain and time domain measurements. These measurements often use alternate hardware signal paths when compared with a similar measurement in the Signal Analysis Mode using the Swept SA measurement. These frequency domain and time domain measurements can be used to output I/Q data results when measuring complex modulated digital signals.

If you are using the Help feature, this mode must be currently active to access its detailed information. If it is not active, exit the Help feature (Esc key), select the mode, and re-access Help.

Key Path	Mode
<b>Example</b>	INST:SEL BASIC INST:NSEL 8
Initial S/W Revision	Prior to A.02.00

### W-CDMA with HSPA+

Selects the W-CDMA with HSPA+ mode for general purpose measurements of signals following this standard. There are several measurements available in this mode.

If you are using the Help feature, this mode must be currently active to access its detailed information. If it is not active, exit the Help feature (Esc key), select the mode, and re-access Help.

Key Path	Mode
<b>Example</b>	INST:SEL WCDMA INST:NSEL 9
Initial S/W Revision	Prior to A.02.00

## GSM/EDGE/EDGE Evo

Selects the GSM with EDGE mode for general purpose measurements of signals following this standard. There are several measurements available in this mode.

If you are using the Help feature, this mode must be currently active to access its detailed information. If it is not active, exit the Help feature (Esc key), select the mode, and re-access Help.

Key Path	Mode
<b>Example</b>	INST:SEL EDGEGSM INST:NSEL 13
Initial S/W Revision	Prior to A.02.00
Modified at S/W Revision	A.02.00

## 802.16 OFDMA (WiMAX/WiBro)

Selects the OFDMA mode for general purpose measurements of WiMAX signals. There are several measurements available in this mode.

If you are using the Help feature, this mode must be currently active to access its detailed information. If it is not active, exit the Help feature (Esc key), select the mode, and re-access Help.

Key Path	Mode
<b>Example</b>	INST:SEL WIMAXOFDMA INST:NSEL 75
Initial S/W Revision	Prior to A.02.00

## Vector Signal Analyzer (VXA)

The N9064A (formerly 89601X) VXA Vector signal and WLAN modulation analysis application provides solutions for basic vector signal analysis, analog demodulation, and digital demodulation. The digital demodulation portion of N9064A allows you to perform measurements on standard-based formats such as cellular, wireless networking and digital video as well as general purpose flexible modulation analysis for wide range of digital formats, FSK to 1024QAM, with easy-to-use measurements and display tools such as constellation and eye diagram, EVM traces and up to four simultaneous displays. Analog baseband analysis is available using the MXA and PXA with option BBA. Option 3FP WLAN has been discontinued.

N9064A honors existing 89601X licenses with all features and functionalities found on X-Series software versions prior to A.06.00. Specifically:

N9064A-1 is equivalent to 89601X-205

N9064A-2 is equivalent to 89601X-AYA

If you are using the Help feature, this mode must be currently active to access its detailed information. If it is not active, exit the Help feature (Esc key), select the mode, and re-access Help.

Key Path	Mode
<b>Example</b>	INST:SEL VSA INST:NSEL 100
Initial S/W Revision	Prior to A.02.00

## Bluetooth

Selects the Bluetooth mode for Bluetooth specific measurements. There are several measurements available in this mode.

If you are using the Help feature, this mode must be currently active to access its detailed information. If it is not active, exit the Help feature (Esc key), select the mode, and re-access Help.

Key Path	Mode
<b>Example</b>	INST:SEL BT INST:NSEL 228
Initial S/W Revision	A.06.01

## TD-SCDMA with HSPA/8PSK

Selects the TD-SCDMA mode for general purpose measurements of signals following this standard. There are several measurements available in this mode.

If you are using the Help feature, this mode must be currently active to access its detailed information. If it is not active, exit the Help feature (Esc key), select the mode, and re-access Help.

Key Path	Mode
<b>Example</b>	INST:SEL TDSCDMA INST:NSEL 211
Initial S/W Revision	Prior to A.02.00

## cdma2000

Selects the cdma2000 mode for general purpose measurements of signals following this standard. There are several measurements available in this mode.

If you are using the Help feature, this mode must be currently active to access its detailed information. If it is not active, exit the Help feature (Esc key), select the mode, and re-access Help.

Key Path	Mode
<b>Example</b>	INST:SEL CDMA2K INST:NSEL 10
Initial S/W Revision	Prior to A.02.00

## 1xEV-DO

Selects the 1xEV-DO mode for general purpose measurements of signals following this standard. There are several measurements available in this mode.

If you are using the Help feature, this mode must be currently active to access its detailed information. If it is not active, exit the Help feature (Esc key), select the mode, and re-access Help.

Key Path	Mode
<b>Example</b>	INST:SEL CDMA1XEV INST:NSEL 15
Initial S/W Revision	Prior to A.02.00

## WLAN

Selects the WLAN mode for general purpose measurements of signals following this standard. There are several measurements available in this mode.

If you are using the Help feature, this mode must be currently active to access its detailed information. If it is not active, exit the Help feature (Esc key), select the mode, and re-access Help.

Key Path	Mode
<b>Example</b>	INST:SEL WLAN INST:NSEL 217
Initial S/W Revision	A.09.491

## LTE-Advanced FDD

If you are using the Help feature, this mode must be currently active to access its detailed information. If it is not active, exit the Help feature (Esc key), select the mode, and re-access Help.

Key Path	Mode
<b>Example</b>	INST:SEL LTEAFDD INST:NSEL 107
Initial S/W Revision	A.14.00

## LTE-Advanced TDD

If you are using the Help feature, this mode must be currently active to access its detailed information. If it is not active, exit the Help feature (Esc key), select the mode, and re-access Help.

Key Path	Mode
<b>Example</b>	INST:SEL LTEATDD INST:NSEL 108
Initial S/W Revision	A.14.00

## Application Mode Number Selection (Remote Command Only)

Select the measurement mode by its mode number. The actual available choices depend upon which applications are installed in your instrument. The modes appear in this table in the same order they appear in the Mode menu (if the order is not changed by the Configure Applications utility found in the System, Power On menu). See "[Detailed List of Modes](#)" on page 150 for Mode details.

The Mode Number is the parameter for use with the :INSTRument:NSElect command. The Mode Parameter is the parameter for use with the :INSTRument[:SElect] command.

Mode	Mode Number	Mode Parameter
Sequence Analyzer	123	SEQAN
I/Q Analyzer (Basic)	8	BASIC
WCDMA with HSPA+	9	WCDMA
GSM/EDGE/EDGE Evo	13	EDGE GSM
Analog Demod	234	ADEM0D
Bluetooth	228	BT00th
TD-SCDMA with HSPA/8PSK	211	TDSCDMA
cdma2000	10	CDMA2K
1xEV-DO	15	CDMA1XEV
LTE	102	LTE
LTE TDD	105	LTETDD
LTE-Advanced FDD	107	LTEAFDD
LTE-Advanced TDD	108	LTEATDD
WLAN	217	WLAN
802.16 OFDM (Fixed WiMAX)	104	WIMAXFIXED

<b>Remote Command</b>	:INSTrument:NSElect <integer> :INSTrument:NSElect?
<b>Example</b>	:INST:NSEL 1
<b>Notes</b>	SA mode is 1 The command must be sequential: i.e. continued parsing of commands cannot proceed until the instrument select is complete and the resultant SCPI trees are available.
<b>Preset</b>	Not affected by Preset. Set to default mode (1 for SA mode) following Restore System Defaults.
<b>State Saved</b>	Saved in instrument state
<b>Initial S/W Revision</b>	Prior to A.02.00

### Application Mode Catalog Query (Remote Command Only)

Returns a string containing a comma separated list of names of all the installed and licensed measurement modes (applications). These names can only be used with the :INSTrument[:SElect] command.

<b>Remote Command</b>	:INSTrument:CATalog?
<b>Example</b>	:INST:CAT?
<b>Notes</b>	Query returns a quoted string of the installed and licensed modes separated with a comma. Example: "SA,PNOISE,WCDMA"
<b>Backwards Compatibility Notes</b>	VSA (E4406A) :INSTrument:CATalog? returned a list of installed INSTRUMENT:SELECT items as a comma separated list of string values: "BASIC","GSM","EDGE GSM","CDMA","NADC","PDC","WCDMA","CDMA2K","CDMA1XEV","IDEN","WIDEN","WLAN","SERVICE" X-Series uses the ESA/PSA compatible query of a string contain comma separated values: "SA,PNOISE,NFIGURE,BASIC,CDMA,CDMA2K,WCDMA,CDMA1XEV,EDGE GSM,GSM,NADC,PDC,TDSCDMA,DMODULATION,WLAN"
<b>Initial S/W Revision</b>	Prior to A.02.00

### Application Identification (Remote Commands Only)

Each entry in the Mode Menu will have a Model Number and associated information: Version, and Options.

This information is displayed in the Show System screen. The corresponding SCPI remote commands are defined here.

"Current Application Model " on page 148

"Current Application Revision" on page 148

"Current Application Options" on page 148

### Current Application Model

Returns a string that is the Model Number of the currently selected application (mode).

<b>Remote Command</b>	:SYSTem:APPLication[:CURRent][:NAME]?
<b>Example</b>	:SYST:APPL?
<b>Notes</b>	Query returns a quoted string that is the Model Number of the currently selected application (Mode). Example: "N9060A" String length is 6 characters.
<b>Preset</b>	Not affected by Preset
<b>State Saved</b>	Not saved in state, the value will be the selected application when a Save is done.
<b>Initial S/W Revision</b>	Prior to A.02.00

### Current Application Revision

Returns a string that is the Revision of the currently selected application (mode).

<b>Remote Command</b>	:SYSTem:APPLication[:CURRent]:REVision?
<b>Example</b>	:SYST:APPL:REV?
<b>Notes</b>	Query returns a quoted string that is the Revision of the currently selected application (Mode). Example: "1.0.0.0" String length is a maximum of 23 characters. (each numeral can be an integer + 3 decimal points)
<b>Preset</b>	Not affected by a Preset
<b>State Saved</b>	Not saved in state, the value will be the selected application when a Save is done.
<b>Initial S/W Revision</b>	Prior to A.02.00

### Current Application Options

Returns a string that is the Options list of the currently selected application (Mode).

<b>Remote Command</b>	:SYSTem:APPLication[:CURRent]:OPTion?
<b>Example</b>	:SYST:APPL:OPT?
<b>Notes</b>	Query returns a quoted string that is the Option list of the currently selected application (Mode). The format is the name as the *OPT? or SYSTem:OPTion command: a comma separated list of option identifiers. Example: "1FP,2FP" String length is a maximum of 255 characters.
<b>Preset</b>	Not affected by a Preset



State Saved	Not saved in state per se, the value will be the selected application when a Save is invoked.
Initial S/W Revision	Prior to A.02.00

## Application Identification Catalog (Remote Commands Only)

A catalog of the installed and licensed applications (Modes) can be queried for their identification.

"Application Catalog Number of Entries" on page 149

"Application Catalog Model Numbers" on page 149

"Application Catalog Revision" on page 149

"Application Catalog Options" on page 150

### Application Catalog Number of Entries

Returns the number of installed and licensed applications (Modes).

<b>Remote Command</b>	:SYSTem:APPLication:CATalog[:NAME]:COUNt?
<b>Example</b>	:SYST:APPL:CAT:COUN?
Preset	Not affected by Preset
State Saved	Not saved in instrument state.
Initial S/W Revision	Prior to A.02.00

### Application Catalog Model Numbers

Returns a list of Model Numbers for the installed and licensed applications (Modes).

<b>Remote Command</b>	:SYSTem:APPLication:CATalog[:NAME]?
<b>Example</b>	:SYST:APPL:CAT?
Notes	Returned value is a quoted string of a comma separated list of Model Numbers. Example, if SAMS and Phase Noise are installed and licensed: "N9060A,N9068A" String length is COUNT * 7 - 1. (7 = Model Number length + 1 for comma. -1 = no comma for the 1st entry.)
Preset	Not affected by a Preset
State Saved	Not saved in instrument state.
Initial S/W Revision	Prior to A.02.00

### Application Catalog Revision

Returns the Revision of the provided Model Number.

<b>Remote Command</b>	:SYSTem:APPLication:CATalog:REVision? <model>
<b>Example</b>	:SYST:APPL:CAT:REV? 'N9060A'
<b>Notes</b>	Returned value is a quoted string of revision for the provided Model Number. The revision will be a null-string ("") if the provided Model Number is not installed and licensed. Example, if SAMS is installed and licensed: "1.0.0.0"
<b>Preset</b>	Not affected by a Preset.
<b>State Saved</b>	Not saved in instrument state.
<b>Initial S/W Revision</b>	Prior to A.02.00

### Application Catalog Options

Returns a list of Options for the provided Model Number

<b>Remote Command</b>	:SYSTem:APPLication:CATalog:OPTion? <model>
<b>Example</b>	:SYST:APPL:CAT:OPT? 'N9060A'
<b>Notes</b>	Returned value is a quoted string of a comma separated list of Options, in the same format as *OPT? or :SYSTem:OPTion?. If the provided Model Number is not installed and licensed a null-string ("") will be returned. Example, if SAMS is installed and licensed: "2FP" String length is a maximum of 255 characters.
<b>Preset</b>	Not affected by a Preset
<b>State Saved</b>	Not saved in instrument state.
<b>Initial S/W Revision</b>	Prior to A.02.00

### Detailed List of Modes

This section contains an alphabetical list of Modes available in the X-Series, along with a brief description of each Mode.

Note that with the exception of the 89601 VSA, only licensed applications appear in the Mode menu. The 89601 will always appear, because it's licensing is handled differently.

#### 1xEV-DO

Selects the 1xEV-DO mode for general purpose measurements of signals following this standard. There are several measurements available in this mode.

If you are using the Help feature, this mode must be currently active to access its detailed information. If it is not active, exit the Help feature (Esc key), select the mode, and re-access Help.

Key Path	Mode
----------	------

<b>Example</b>	INST:SEL CDMA1XEV INST:NSEL 15
Initial S/W Revision	Prior to A.02.00

### 802.16 OFDMA (WiMAX/WiBro)

Selects the OFDMA mode for general purpose measurements of WiMAX signals. There are several measurements available in this mode.

If you are using the Help feature, this mode must be currently active to access its detailed information. If it is not active, exit the Help feature (Esc key), select the mode, and re-access Help.

Key Path	Mode
<b>Example</b>	INST:SEL WIMAXOFDMA INST:NSEL 75
Initial S/W Revision	Prior to A.02.00

### 89601 VSA

Selecting the 89601 VSA mode will start the 89600 VSA software. The 89600 VSA software is powerful, PC-based software, offering the industry's most sophisticated general purpose and standards specific signal evaluation and troubleshooting tools for R&D engineers. Even for proprietary and non-standard signals in SATCOM or MILCOM applications, you can make signal quality measurements with customized IQ constellation. Reach deeper into signals, gather more data on signal problems, and gain greater insight.

- Over 35 general-purpose analog and digital demodulators ranging from 2FSK to 4096QAM
- Flexible and custom IQ and OFDM signal analysis for single carrier
- Standards specific modulation analysis including:
  - Cellular: GSM/EDGE, cdma2000, W-CDMA, TD-SCDMA, LTE(FDD/TDD),
  - LTE-Advanced and more
  - Wireless networking: 802.11a/b/g, 802.11n, 802.ac, 802.16 WiMAX (fixed/mobile), WiSUN (MR-FSK PHY)
  - RFID
  - Digital satellite video and other satellite signals, radar, LMDS
  - Up to 400K bin FFT, for the highest resolution spectrum analysis
  - A full suite of time domain analysis tools, including signal capture and playback, time gating, and CCDF measurements
  - 20 simultaneous trace displays and the industry's most complete set of marker functions
  - Easy-to-use Microsoft Windows graphical user interface

For more information see the Keysight 89600 Series VSA web site at [www.keysight.com/find/89600vsa](http://www.keysight.com/find/89600vsa)

To learn more about how to use the 89600 VSA running in the X-Series, after the 89600 VSA software is running, open the 89600 VSA Help and open the "About Keysight X-Series Signal Analyzer with 89600 VSA Software" help topic.

Key Path	Mode
<b>Example</b>	INST:SEL VSA89601 INST:NSEL 101
Initial S/W Revision	Prior to A.02.00

### Analog Demod

Selects the Analog Demod mode for making measurements of AM, FM and phase modulated signals.

If you are using the Help feature, this mode must be currently active to access its detailed information. If it is not active, exit the Help feature (Esc key), select the mode, and re-access Help.

Key Path	Mode
<b>Example</b>	INST:SEL ADEMODO INST:NSEL 234
Initial S/W Revision	Prior to A.02.00

### Bluetooth

Selects the Bluetooth mode for Bluetooth specific measurements. There are several measurements available in this mode.

If you are using the Help feature, this mode must be currently active to access its detailed information. If it is not active, exit the Help feature (Esc key), select the mode, and re-access Help.

Key Path	Mode
<b>Example</b>	INST:SEL BT INST:NSEL 228
Initial S/W Revision	A.06.01

### cdma2000

Selects the cdma2000 mode for general purpose measurements of signals following this standard. There are several measurements available in this mode.

If you are using the Help feature, this mode must be currently active to access its detailed information. If it is not active, exit the Help feature (Esc key), select the mode, and re-access Help.

Key Path	Mode
<b>Example</b>	INST:SEL CDMA2K INST:NSEL 10
Initial S/W Revision	Prior to A.02.00

### GSM/EDGE/EDGE Evo

Selects the GSM with EDGE mode for general purpose measurements of signals following this standard. There are several measurements available in this mode.

If you are using the Help feature, this mode must be currently active to access its detailed information. If it is not active, exit the Help feature (Esc key), select the mode, and re-access Help.

Key Path	Mode
<b>Example</b>	INST:SEL EDGEGSM INST:NSEL 13
Initial S/W Revision	Prior to A.02.00
Modified at S/W Revision	A.02.00

### IQ Analyzer (Basic)

The IQ Analyzer Mode makes general purpose frequency domain and time domain measurements. These measurements often use alternate hardware signal paths when compared with a similar measurement in the Signal Analysis Mode using the Swept SA measurement. These frequency domain and time domain measurements can be used to output I/Q data results when measuring complex modulated digital signals.

If you are using the Help feature, this mode must be currently active to access its detailed information. If it is not active, exit the Help feature (Esc key), select the mode, and re-access Help.

Key Path	Mode
<b>Example</b>	INST:SEL BASIC INST:NSEL 8
Initial S/W Revision	Prior to A.02.00

### LTE

Selects the LTE mode for general purpose measurements of signals following the LTE FDD standard. There are several measurements available in this mode.

If you are using the Help feature, this mode must be currently active to access its detailed information. If it is not active, exit the Help feature (Esc key), select the mode, and re-access Help.

Key Path	Mode
<b>Example</b>	INST:SEL LTE INST:NSEL 102
Initial S/W Revision	Prior to A.02.00

### LTE TDD

Selects the LTE TDD mode for general purpose measurements of signals following the LTE TDD standard. There are several measurements available in this mode.

If you are using the Help feature, this mode must be currently active to access its detailed information. If it is not active, exit the Help feature (Esc key), select the mode, and re-access Help.

Key Path	Mode
<b>Example</b>	INST:SEL LTETDD INST:NSEL 105
Initial S/W Revision	A.03.00

### LTE-Advanced FDD

If you are using the Help feature, this mode must be currently active to access its detailed information. If it is not active, exit the Help feature (Esc key), select the mode, and re-access Help.

Key Path	Mode
<b>Example</b>	INST:SEL LTEAFDD INST:NSEL 107
Initial S/W Revision	A.14.00

### LTE-Advanced TDD

If you are using the Help feature, this mode must be currently active to access its detailed information. If it is not active, exit the Help feature (Esc key), select the mode, and re-access Help.

Key Path	Mode
<b>Example</b>	INST:SEL LTEATDD INST:NSEL 108
Initial S/W Revision	A.14.00

## Sequence Analyzer

Selects the Sequence Analyzer mode for sequenced measurements. Depending on licensed applications there may be a number of different measurements available in this mode. These measurements are all done on IQ captured data and can be set up to calculated on any part of the capture.

If you are using the Help feature, this mode must be currently active to access its detailed information. If it is not active, exit the Help feature (Esc key), select the mode, and re-access Help.

Key Path	Mode
<b>Example</b>	INST:SEL SEQAN INST:NSEL 400
Initial S/W Revision	A.05.01

## TD-SCDMA with HSPA/8PSK

Selects the TD-SCDMA mode for general purpose measurements of signals following this standard. There are several measurements available in this mode.

If you are using the Help feature, this mode must be currently active to access its detailed information. If it is not active, exit the Help feature (Esc key), select the mode, and re-access Help.

Key Path	Mode
<b>Example</b>	INST:SEL TDSCDMA INST:NSEL 211
Initial S/W Revision	Prior to A.02.00

## Vector Signal Analyzer (VXA)

The N9064A (formerly 89601X) VXA Vector signal and WLAN modulation analysis application provides solutions for basic vector signal analysis, analog demodulation, and digital demodulation. The digital demodulation portion of N9064A allows you to perform measurements on standard-based formats such as cellular, wireless networking and digital video as well as general purpose flexible modulation analysis for wide range of digital formats, FSK to 1024QAM, with easy-to-use measurements and display tools such as constellation and eye diagram, EVM traces and up to four simultaneous displays. Analog baseband analysis is available using the MXA and PXA with option BBA. Option 3FP WLAN has been discontinued.

N9064A honors existing 89601X licenses with all features and functionalities found on X-Series software versions prior to A.06.00. Specifically:

N9064A-1 is equivalent to 89601X-205

N9064A-2 is equivalent to 89601X-AYA

If you are using the Help feature, this mode must be currently active to access its detailed information. If it is not active, exit the Help feature (Esc key), select the mode, and re-access Help.

Key Path	Mode
<b>Example</b>	INST:SEL VSA INST:NSEL 100
Initial S/W Revision	Prior to A.02.00

### W-CDMA with HSPA+

Selects the W-CDMA with HSPA+ mode for general purpose measurements of signals following this standard. There are several measurements available in this mode.

If you are using the Help feature, this mode must be currently active to access its detailed information. If it is not active, exit the Help feature (Esc key), select the mode, and re-access Help.

Key Path	Mode
<b>Example</b>	INST:SEL WCDMA INST:NSEL 9
Initial S/W Revision	Prior to A.02.00

### WLAN

Selects the WLAN mode for general purpose measurements of signals following this standard. There are several measurements available in this mode.

If you are using the Help feature, this mode must be currently active to access its detailed information. If it is not active, exit the Help feature (Esc key), select the mode, and re-access Help.

Key Path	Mode
<b>Example</b>	INST:SEL WLAN INST:NSEL 217
Initial S/W Revision	A.09.491

### Global Settings

Opens a menu that allows you to switch certain Meas Global parameters to a Mode Global state. These switches apply to all Modes that support global settings. No matter what Mode you are in when you set the “Global Center Frequency” switch to on, it applies to all Modes that support Global Settings.

Key Path	Mode Setup
Initial S/W Revision	Prior to A.02.00



## Global Center Freq

The software maintains a Mode Global value called “Global Center Freq”.

When the Global Center Freq key is switched to On in any mode, the current mode’s center frequency is copied into the Global Center Frequency, and from then on all modes that support global settings use the Global Center Frequency. So you can switch between any of these modes and the Center Freq will remain unchanged.

Adjusting the Center Freq of any mode which supports Global Settings, while Global Center Freq is On, will modify the Global Center Frequency.

When Global Center Freq is turned Off, the Center Freq of the current mode is unchanged, but now the Center Freq of each mode is once again independent.

When Mode Preset is pressed while Global Center Freq is On, the Global Center Freq is preset to the preset Center Freq of the current mode.

This function is reset to Off when the Restore Defaults key is pressed in the Global Settings menu, or when System, Restore Defaults, All Modes is pressed.

<b>Key Path</b>	Mode Setup, Global Settings
<b>Scope</b>	Mode Global
<b>Remote Command</b>	:INSTrument:COUPle:FREQuency:CENTer ALL NONE :INSTrument:COUPle:FREQuency:CENTer?
<b>Example</b>	INST:COUP:FREQ:CENT ALL INST:COUP:FREQ:CENT?
<b>Preset</b>	Set to Off on Global Settings, Restore Defaults and System, Restore Defaults, All Modes
<b>Range</b>	On Off
<b>Initial S/W Revision</b>	Prior to A.02.00

<b>Remote Command</b>	:GLOBal:FREQuency:CENTer[:STATe] 1 0 ON OFF :GLOBal:FREQuency:CENTer[:STATe]?
<b>Preset</b>	Off
<b>Initial S/W Revision</b>	Prior to A.02.00

## Restore Defaults

This key resets all of the functions in the Global Settings menu to Off. This also occurs when System, Restore Defaults, All Modes is pressed.

<b>Key Path</b>	Mode Setup, Global Settings
<b>Remote Command</b>	:INSTrument:COUPle:DEFault

<b>Example</b>	INST:COUP:DEF
<b>Backwards Compatibility SCPI</b>	:GLOBal:DEFault
Initial S/W Revision	Prior to A.02.00

## Mode Setup

Enables you to select mode parameters. These settings are available for all measurements in the current mode.

Key Path	Front panel
----------	-------------

### Radio Device

Allows you to specify the device to be used.

Key Path	Mode Setup
Mode	WIMAXOFDMA
Scope	Meas Global
<b>Remote Command</b>	<code>[ :SENSe ] :RADio:STANdard:DEVIce BTS   MS</code> <code>[ :SENSe ] :RADio:STANdard:DEVIce?</code>
<b>Example</b>	<code>RAD:STAN:DEV BTS</code> <code>RAD:STAN:DEV?</code>
Notes	Radio device BTS is called BS in the WiMAX-OFDMA mode. BS is used in the front panel and BTS is used for the remote command.
Preset	BTS
State Saved	Saved in instrument state.
Range	BS   MS
Initial S/W Revision	Prior to A.02.00

### Radio Standard

The following standards are supported in the WiMAX-OFDMA Measurement Application:

IEEE 802.16e-2005

WiBro (Korean mobile WiMAX-OFDMA service)

Key Path	Mode Setup, Radio
Mode	WIMAXOFDMA
Scope	Meas Global
<b>Remote Command</b>	<code>[ :SENSe ] :RADio:STANdard WM80216E05   WIBRO</code> <code>[ :SENSe ] :RADio:STANdard?</code>
<b>Example</b>	<code>RAD:STAN WIBRO</code> <code>RAD:STAN?</code>
Preset	WM80216E05

State Saved	Saved in instrument state.
Range	IEEE 802.16e-2005 WiBro
Initial S/W Revision	Prior to A.02.00

### 802.16e-2005 mode

Key Path	Mode Setup, Radio Std
Mode	WIMAXOFDMA
Scope	Meas Global
<b>Remote Command</b>	[ :SENSe]:RADio:STANdard:Y05[:PROFile] B1M25   B3M5   B5M   B7M   B8M75   B10M   B14M   B15M   B17M5   B20M   B28M  [:SENSe]:RADio:STANdard:Y05[:PROFile]?
<b>Example</b>	RAD:STAN:Y05 B10M RAD:STAN:Y05?
Preset	B10M
State Saved	Saved in instrument state.
Range	1.25MHz 3.5MHz 5MHz 7MHz 8.75MHz 10MHz 14MHz 15MHz 17.5MHz 20MHz 28MHz
Initial S/W Revision	Prior to A.02.00

### FFT Size

OFDMA supports a scalable frame structure where the FFT size scales with the bandwidth to keep the subcarrier spacing fixed. Four FFT "NFFT" sizes are specified by the OFDMA standard: 128, 512, 1024 and 2048.

Key Path	Mode Setup, Radio Std
Mode	WIMAXOFDMA
Scope	Meas Global
<b>Remote Command</b>	[ :SENSe]:RADio:STANdard:BANDwidth[:CONFigure]:NFFT <integer> [:SENSe]:RADio:STANdard:BANDwidth[:CONFigure]:NFFT?
<b>Example</b>	RAD:STAN:BAND:NFFT 1024 RAD:STAN:BAND:NFFT?
Preset	1024
State Saved	Saved in instrument state.
Range	128 512 1024 2048
Min	128
Max	2048
Initial S/W Revision	Prior to A.02.00

## BW Ratio

BW Ratio is defined as the ratio between the OFDMA FFT sample rate and the nominal channel bandwidth. The 802.16 Standard specifies that the BW Ratio be set to 8/7 or 28/25 depending on the nominal bandwidth of the test signal.

Key Path	Mode Setup, Radio, Radio Std
Mode	WIMAXOFDMA
Scope	Meas Global
<b>Remote Command</b>	[ :SENSe ] :RADio:STANdard:BANDwidth[:CONFigure]:BWRatio R8BY7   R28BY25 [ :SENSe ] :RADio:STANdard:BANDwidth[:CONFigure]:BWRatio?
<b>Example</b>	RAD:STAN:BAND:BWR R8BY7 RAD:STAN:BAND:BWR?
Notes	Force Restart is unavailable when WiBro is selected as the Radio Standard (described in " <a href="#">Radio Device</a> " on page 159).
Preset	R28BY25
State Saved	Saved in instrument state.
Range	8/7 28/25
Initial S/W Revision	Prior to A.02.00

## Guard Interval

IEEE 802.16 OFDMA supports multiple Guard Interval implementations. Each measurement changes its defaults according to the selected standard or device, if necessary.

Key Path	Mode Setup, Radio Std
Mode	WIMAXOFDMA
Scope	Meas Global
<b>Remote Command</b>	[ :SENSe ] :RADio:STANdard:GINTerval:RATio R1BY32   R1BY16   R1BY8   R1BY4 [ :SENSe ] :RADio:STANdard:GINTerval:RATio?
<b>Example</b>	RAD:STAN:GINT:RAT R1BY8 RAD:STAN:GINT:RAT?
Notes	Force Restart is unavailable when WiBro is selected as the Radio Standard (described in " <a href="#">Radio Device</a> " on page 159).
Couplings	Radio Standard or Radio Device preset this to default.
Preset	R1BY8
State Saved	Saved in instrument state.
Range	1/32 1/16 1/8 1/4
Initial S/W Revision	Prior to A.02.00

## Frame Duration

The Frame Duration parameter specifies OFDMA frame duration in units of time.

You can use the Radio Standard or Radio Device preset to set the Frame Duration to a value specified in the OFDMA standard or you can specify an arbitrary value manually in the Frame Duration parameter.

Key Path	Mode Setup, Radio Std
Mode	WIMAXOFDMA
Scope	Meas Global
<b>Remote Command</b>	<code>[ :SENSe ] :RADio:STANdard:FDURation &lt;time&gt;</code> <code>[ :SENSe ] :RADio:STANdard:FDURation</code>
<b>Example</b>	<code>RAD:STAN:FDUR 5</code> <code>RAD:STAN:FDUR?</code>
Notes	The Actual Frame Duration value is selected that is closest in value to one of the following discrete numbers: 2, 2.5, 4, 5, 8, 10, 12.5, 20 ms.
Couplings	Radio Standard or Radio Device preset this parameter to the default length value.
Preset	5.0 ms
State Saved	Saved in instrument state.
Min	2 ms
Max	20 ms
Initial S/W Revision	Prior to A.02.00

## Downlink Ratio

Downlink Ratio, expressed as a percentage, is the ratio of the downlink subframe length (including the TTG) to the frame length. Downlink Ratio defines where the uplink subframe starts relative to the start of the frame. A 30% Downlink Ratio means that 30% of the frame length is downlink subframe and 70% is uplink subframe.

Key Path	Mode Setup, Radio Std
Mode	WIMAXOFDMA
Scope	Meas Global
<b>Remote Command</b>	<code>[ :SENSe ] :RADio:STANdard:DRATio &lt;real&gt;</code> <code>[ :SENSe ] :RADio:STANdard:DRATio</code>
<b>Example</b>	<code>RAD:STAN:DRAT 50.0</code> <code>RAD:STAN:DRAT?</code>
Couplings	Radio Standard or Radio Device preset this parameter to the default length value.
Preset	61.771 %
State Saved	Saved in instrument state.
Min	0 %

Max	100 %
Initial S/W Revision	Prior to A.02.00

## WiBro mode

Key Path	Mode Setup, Radio Std, WiBro
Mode	WIMAXOFDMA
Scope	Meas Global
<b>Remote Command</b>	[ :SENSE ] :RADio:STANdard:WIBRo [ :PROFile ] B4M375   B8M75   B17M5 [ :SENSE ] :RADio:STANdard:WIBRo [ :PROFile ] ?
<b>Example</b>	RAD:STAN:WIBR B8M75 RAD:STAN:WIBR?
Preset	B8M75
State Saved	Saved in instrument state.
Range	4.375MHz 8.75MHz 17.5MHz
Initial S/W Revision	Prior to A.02.00

## FFT Size

OFDMA supports a scalable frame structure where the FFT size scales with the bandwidth to keep the subcarrier spacing fixed. Four FFT "NFFT" sizes are specified by the OFDMA standard: 128, 512, 1024 and 2048.

Key Path	Mode Setup, Radio Std
Mode	WIMAXOFDMA
Scope	Meas Global
<b>Remote Command</b>	[ :SENSE ] :RADio:STANdard:BANDwidth [ :CONFigure ] :NFFT <integer> [ :SENSE ] :RADio:STANdard:BANDwidth [ :CONFigure ] :NFFT?
<b>Example</b>	RAD:STAN:BAND:NFFT 1024 RAD:STAN:BAND:NFFT?
Preset	1024
State Saved	Saved in instrument state.
Range	128 512 1024 2048
Min	128
Max	2048
Initial S/W Revision	Prior to A.02.00

## BW Ratio

BW Ratio is defined as the ratio between the OFDMA FFT sample rate and the nominal channel bandwidth. The 802.16 Standard specifies that the BW Ratio be set to 8/7 or 28/25 depending on the nominal bandwidth of the test signal.

Key Path	Mode Setup, Radio, Radio Std
Mode	WIMAXOFDMA
Scope	Meas Global
<b>Remote Command</b>	[ :SENSe]:RADio:STANdard:BANdwidth[:CONFIgure]:BWRatio R8BY7   R28BY25 [ :SENSe]:RADio:STANdard:BANdwidth[:CONFIgure]:BWRatio?
<b>Example</b>	RAD:STAN:BAND:BWR R8BY7 RAD:STAN:BAND:BWR?
Notes	Force Restart is unavailable when WiBro is selected as the Radio Standard (described in " <a href="#">Radio Device</a> " on page 159).
Preset	R28BY25
State Saved	Saved in instrument state.
Range	8/7 28/25
Initial S/W Revision	Prior to A.02.00

## Guard Interval

IEEE 802.16 OFDMA supports multiple Guard Interval implementations. Each measurement changes its defaults according to the selected standard or device, if necessary.

Key Path	Mode Setup, Radio Std
Mode	WIMAXOFDMA
Scope	Meas Global
<b>Remote Command</b>	[ :SENSe]:RADio:STANdard:GINTErval:RATio R1BY32   R1BY16   R1BY8   R1BY4 [ :SENSe]:RADio:STANdard:GINTErval:RATio?
<b>Example</b>	RAD:STAN:GINT:RAT R1BY8 RAD:STAN:GINT:RAT?
Notes	Force Restart is unavailable when WiBro is selected as the Radio Standard (described in " <a href="#">Radio Device</a> " on page 159).
Couplings	Radio Standard or Radio Device preset this to default.
Preset	R1BY8
State Saved	Saved in instrument state.
Range	1/32 1/16 1/8 1/4
Initial S/W Revision	Prior to A.02.00



## Frame Duration

The Frame Duration parameter specifies OFDMA frame duration in units of time.

You can use the Radio Standard or Radio Device preset to set the Frame Duration to a value specified in the OFDMA standard or you can specify an arbitrary value manually in the Frame Duration parameter.

Key Path	Mode Setup, Radio Std
Mode	WIMAXOFDMA
Scope	Meas Global
<b>Remote Command</b>	<code>[ :SENSe ] :RADio:STANdard:FDURation &lt;time&gt;</code> <code>[ :SENSe ] :RADio:STANdard:FDURation</code>
<b>Example</b>	<code>RAD:STAN:FDUR 5</code> <code>RAD:STAN:FDUR?</code>
Notes	The Actual Frame Duration value is selected that is closest in value to one of the following discrete numbers: 2, 2.5, 4, 5, 8, 10, 12.5, 20 ms.
Couplings	Radio Standard or Radio Device preset this parameter to the default length value.
Preset	5.0 ms
State Saved	Saved in instrument state.
Min	2 ms
Max	20 ms
Initial S/W Revision	Prior to A.02.00

## Downlink Ratio

Downlink Ratio, expressed as a percentage, is the ratio of the downlink subframe length (including the TTG) to the frame length. Downlink Ratio defines where the uplink subframe starts relative to the start of the frame. A 30% Downlink Ratio means that 30% of the frame length is downlink subframe and 70% is uplink subframe.

Key Path	Mode Setup, Radio Std
Mode	WIMAXOFDMA
Scope	Meas Global
<b>Remote Command</b>	<code>[ :SENSe ] :RADio:STANdard:DRATio &lt;real&gt;</code> <code>[ :SENSe ] :RADio:STANdard:DRATio</code>
<b>Example</b>	<code>RAD:STAN:DRAT 50.0</code> <code>RAD:STAN:DRAT?</code>
Couplings	Radio Standard or Radio Device preset this parameter to the default length value.
Preset	61.771 %
State Saved	Saved in instrument state.
Min	0 %

Max	100 %
Initial S/W Revision	Prior to A.02.00

## Preset Profile

IEEE 802.16 OFDMA supports multiple system profile (bandwidth) implementations. This selection changes parameters in each measurement according to the selected standard if necessary.

### 802.16e–2005 mode

Key Path	Mode Setup, Radio Std
Mode	WIMAXOFDMA
Scope	Meas Global
<b>Remote Command</b>	[ :SENSe ] :RADio:STANdard:Y05 [ :PROFile ] B1M25   B3M5   B5M   B7M   B8M75   B10M   B14M   B15M   B17M5   B20M   B28M  [ :SENSe ] :RADio:STANdard:Y05 [ :PROFile ] ?
<b>Example</b>	RAD:STAN:Y05 B10M RAD:STAN:Y05?
Preset	B10M
State Saved	Saved in instrument state.
Range	1.25MHz 3.5MHz 5MHz 7MHz 8.75MHz 10MHz 14MHz 15MHz 17.5MHz 20MHz 28MHz
Initial S/W Revision	Prior to A.02.00

### WiBro mode

Key Path	Mode Setup, Radio Std, WiBro
Mode	WIMAXOFDMA
Scope	Meas Global
<b>Remote Command</b>	[ :SENSe ] :RADio:STANdard:WIBRo [ :PROFile ] B4M375 B8M75 B17M5  [ :SENSe ] :RADio:STANdard:WIBRo [ :PROFile ] ?
<b>Example</b>	RAD:STAN:WIBR B8M75 RAD:STAN:WIBR?
Preset	B8M75
State Saved	Saved in instrument state.
Range	4.375MHz 8.75MHz 17.5MHz
Initial S/W Revision	Prior to A.02.00

## Restore Mode Defaults

Resets the state for the currently active mode by resetting the mode persistent settings to their factory default values, clearing mode data and by performing a Mode Preset. This function will never cause a mode switch. This function performs a full preset for the currently active mode; whereas, Mode Preset performs a partial preset. Restore Mode Defaults does not affect any system settings. System settings are reset by the Restore System Defaults function. This function does reset mode data; as well as settings.

Key Path	Mode Setup
Remote Command	:INSTrument:DEFault
Example	:INST:DEF
Notes	Clears all pending OPC bits. The Status Byte is set to 0. A message comes up saying: "If you are sure, press key again".
Couplings	A Restore Mode Defaults will cause the currently running measurement to be aborted and causes the default measurement to be active. It gets the mode to a consistent state with all of the default couplings set.
Initial S/W Revision	Prior to A.02.00

## Preset Type (Remote Command Only)

As stated in the Backward Compatibility section, to be compatible with ESA/PSA the PRESet:TYPE command will be implemented as a no-op.

Mode	All
Remote Command	:SYSTem:PRESet:TYPE FACTory MODE USER :SYSTem:PRESet:TYPE?
Example	:SYST:PRE:TYPE FACT
Notes	This command is supported for backward compatibility only. It is a no-op which does not change the behavior of any preset operation.
Preset	This is unaffected by Preset but is set to Mode on a "Restore System Defaults->All"
State Saved	No
Initial S/W Revision	Prior to A.02.00

## Global Settings

Opens a menu that allows you to switch certain Meas Global parameters to a Mode Global state. These switches apply to all Modes that support global settings. No matter what Mode you are in when you set the "Global Center Frequency" switch to on, it applies to all Modes that support Global Settings.

Key Path	Mode Setup
Initial S/W Revision	Prior to A.02.00

## Global Center Freq

The software maintains a Mode Global value called “Global Center Freq”.

When the Global Center Freq key is switched to On in any mode, the current mode’s center frequency is copied into the Global Center Frequency, and from then on all modes that support global settings use the Global Center Frequency. So you can switch between any of these modes and the Center Freq will remain unchanged.

Adjusting the Center Freq of any mode which supports Global Settings, while Global Center Freq is On, will modify the Global Center Frequency.

When Global Center Freq is turned Off, the Center Freq of the current mode is unchanged, but now the Center Freq of each mode is once again independent.

When Mode Preset is pressed while Global Center Freq is On, the Global Center Freq is preset to the preset Center Freq of the current mode.

This function is reset to Off when the Restore Defaults key is pressed in the Global Settings menu, or when System, Restore Defaults, All Modes is pressed.

Key Path	Mode Setup, Global Settings
Scope	Mode Global
Remote Command	:INSTrument:COUPle:FREQuency:CENTer ALL NONE :INSTrument:COUPle:FREQuency:CENTer?
Example	INST:COUP:FREQ:CENT ALL INST:COUP:FREQ:CENT?
Preset	Set to Off on Global Settings, Restore Defaults and System, Restore Defaults, All Modes
Range	On Off
Initial S/W Revision	Prior to A.02.00

Remote Command	:GLOBal:FREQuency:CENTer[:STATe] 1 0 ON OFF :GLOBal:FREQuency:CENTer[:STATe]?
Preset	Off
Initial S/W Revision	Prior to A.02.00

## Restore Defaults

This key resets all of the functions in the Global Settings menu to Off. This also occurs when System, Restore Defaults, All Modes is pressed.

Key Path	Mode Setup, Global Settings
Remote Command	:INSTrument:COUPle:DEFault

<b>Example</b>	INST:COUP:DEF
<b>Backwards Compatibility SCPI</b>	:GLOBal:DEFault
Initial S/W Revision	Prior to A.02.00

## SCPI Only Commands

This mode has the following additional mode-unique commands.

### Nominal Bandwidth

The Nominal Bandwidth parameter specifies the nominal channel bandwidth. OFDMA supports a scalable frame structure where the FFT size scales according to the bandwidth to keep subcarrier spacing fixed. The OFDMA standard specifies four FFT "NFFT" sizes" (128, 512, 1024 and 2048) and, in addition, supports many nominal bandwidths. You can use the Preset to Standard to set the Nominal Bandwidth to a standard default value or you can specify an arbitrary value with this command.

#### How the analyzer determines Nominal Bandwidth:

The IEEE 802.16e-2005 standard defines the Sampling Frequency( $F_s$ ) as:

$$F_s = \text{floor}(\text{BWRatio} * \text{BW} / 8000) * 8000$$

This is the sample rate for a non-oversampled OFDMA signal. This equation restricts the sampling frequency to 8 kHz increments. To facilitate R&D development and debug-mode analysis of an OFDMA DUT, the analyzer allows arbitrary Sampling Frequency. To implement this capability, the analyzer does not use the "floor" function to compute the Sampling Frequency, but instead uses the following formula:

$$\text{Nominal BW (analyzer)} = F_s / \text{BWRatio}$$

#### NOTE

This functionality is only available with SCPI control and is recommended only for the advanced user.

<b>Mode</b>	WIMAXOFDMA
<b>Scope</b>	Meas Global
<b>Remote Command</b>	[ :SENSE ] :RADio:STANdard:BANDwidth[:CONFigure]:VALue <freq> [ :SENSe ] :RADio:STANdard:BANDwidth[:CONFigure]:VALue?
<b>Example</b>	RAD:STAN:BAND:VAL 9.996 MHz RAD:STAN:BAND:VAL?
<b>Preset</b>	10 MHz
<b>State Saved</b>	Saved in instrument state.
<b>Min</b>	31.25 kHz
<b>Max</b>	200 MHz
Initial S/W Revision	Prior to A.02.00

## BW Ratio – Fractional Number

The BW Ratio is defined as the ratio between the OFDMA FFT sample rate and the nominal channel bandwidth.

This parameter is represented as a fractional number that contains two values; the first value is the numerator and the second is the denominator value of the BW Ratio.

**NOTE** This functionality is only available with SCPI control and is recommended only for the advanced user.

Mode	WIMAXOFDMA
Scope	Meas Global
Remote Command	<code>[[:SENSE]:RADIO:STANDARD:BANDWIDTH[:CONFIGURE]:BWRATIO:FRACTION &lt;integer&gt;, &lt;integer&gt;</code> <code>[[:SENSE]:RADIO:STANDARD:BANDWIDTH[:CONFIGURE]:BWRATIO:FRACTION?</code>
Example	<code>RAD:STAN:BAND:BWR:FRAC 11,10</code> <code>RAD:STAN:BAND:BWR:FRAC?</code>
Notes	SCPI Only. No Front Panel Access. The value of this fraction should be between 1.0 to 2.0
Preset	28,25
State Saved	Saved in instrument state.
Min	1
Max	1000
Initial S/W Revision	Prior to A.02.00

## Guard Interval – Fractional Number

IEEE 802.16 OFDMA supports multiple Guard Interval implementations. Each measurement changes its defaults according to the selected standard or device, if necessary. For the advanced user, the Guard Interval can be set to a value other than the standard values (1/4, 1/8, 1/16 or 1/32).

This parameter is represented as a fractional number that contains two values; the first value is the numerator and the second is the denominator value of the Guard Interval.

**NOTE** This functionality is only available with SCPI control and is recommended only for the advanced user.

Mode	WIMAXOFDMA
Scope	Meas Global
Remote Command	<code>[[:SENSE]:RADIO:STANDARD:GINTerval:RATio:FRACTION &lt;integer&gt;, &lt;integer&gt;</code> <code>[[:SENSE]:RADIO:STANDARD:GINTerval:RATio:FRACTION?</code>
Example	<code>RAD:STAN:GINT:RAT:FRAC 3,18</code> <code>RAD:STAN:GINT:RAT:FRAC?</code>
Notes	SCPI Only. No Front Panel Access.

	The value of this fraction should be between 0.0 to 1.0
Preset	1, 8
State Saved	Saved in instrument state.
Min	0
Max	1000
Initial S/W Revision	Prior to A.02.00

## Zone Map Data

Gets and sets the downlink and uplink zone definitions for a particular 802.16 OFDMA signal. Its parameter is a comma-separated string list which contains pairs of a key and a value. The key definition is basically equivalent to “.omf” originally created by the 89600, except the leading string “DemodOfdmaMap\_” can be omitted. When only a partial change of the existent map is desired, the parameter must contain the pair of “[DemodOfdmaMap\_]RefreshMap” and “FALSE”. A query returns all key-and-value pairs which is saved as the state in your X-Series Analyzer.

Mode	WIMAXOFDMA
Scope	Meas Global
Remote Command	:CALCulate:ZMAP:DATA <string>, ... :CALCulate:ZMAP:DATA?
Example	CALC:ZMAP:DATA "RefreshMap", "FALSE", "F1_DL_Z1_Len", "3" CALC:ZMAP:DATA?
Notes	SCPI Only. No Front Access. The SCPI parameter must be pairs of a key and a value.
Preset	"DemodOfdmaMap_AutoDetect", "FALSE", "DemodOfdmaMap_Count", "1", "DemodOfdmaMap_F1_DL_Count", "1", "DemodOfdmaMap_F1_DL_Z1_Active", "TRUE", "DemodOfdmaMap_F1_DL_Z1_AmcType", "1", "DemodOfdmaMap_F1_DL_Z1_B1_Active", "TRUE", "DemodOfdmaMap_F1_DL_Z1_B1_AllocType", "0", "DemodOfdmaMap_F1_DL_Z1_B1_Boost", "0", "DemodOfdmaMap_F1_DL_Z1_B1_BurstType", "1", "DemodOfdmaMap_F1_DL_Z1_B1_ColorIndex", "80", "DemodOfdmaMap_F1_DL_Z1_B1_ModType", "4", "DemodOfdmaMap_F1_DL_Z1_B1_Name", "<FCH>", "DemodOfdmaMap_F1_DL_Z1_B1_SubchannelInterval", "4", "DemodOfdmaMap_F1_DL_Z1_B1_SubchannelOffset", "0", "DemodOfdmaMap_F1_DL_Z1_B1_SymbolInterval", "2", "DemodOfdmaMap_F1_DL_Z1_B1_SymbolOffset", "0", "DemodOfdmaMap_F1_DL_Z1_Count", "1", "DemodOfdmaMap_F1_DL_Z1_DedicPilots", "FALSE", "DemodOfdmaMap_F1_DL_Z1_IDCell", "0", "DemodOfdmaMap_F1_DL_Z1_IDCellCouple", "FALSE", "DemodOfdmaMap_F1_DL_Z1_Len", "2", "DemodOfdmaMap_F1_DL_Z1_Locked", "FALSE", "DemodOfdmaMap_F1_DL_Z1_Name", "Zone01", "DemodOfdmaMap_F1_DL_Z1_PrbsID", "0", "DemodOfdmaMap_F1_DL_Z1_StcMatrix", "0", "DemodOfdmaMap_F1_DL_Z1_StcType", "0", "DemodOfdmaMap_F1_DL_Z1_SymOffset", "1", "DemodOfdmaMap_F1_DL_Z1_UseAllSC", "FALSE", "DemodOfdmaMap_F1_DL_Z1_WrapType", "0", "DemodOfdmaMap_F1_DL_Z1_ZoneType", "0", "DemodOfdmaMap_F1_UL_Count", "1", "DemodOfdmaMap_F1_UL_Z1_Active", "TRUE", "DemodOfdmaMap_F1_UL_Z1_AmcType", "1", "DemodOfdmaMap_F1_UL_Z1_B1_Active", "TRUE", "DemodOfdmaMap_F1_UL_Z1_B1_AllocType",

---

	"1", "DemodOfdmaMap_F1_UL_Z1_B1_Boost", "0", "DemodOfdmaMap_F1_UL_Z1_B1_BurstType", "0", "DemodOfdmaMap_F1_UL_Z1_B1_ColorIndex", "1", "DemodOfdmaMap_F1_UL_Z1_B1_ModType", "4", "DemodOfdmaMap_F1_UL_Z1_B1_Name", "Burst01", "DemodOfdmaMap_F1_UL_Z1_B1_PilotPattern", "0", "DemodOfdmaMap_F1_UL_Z1_B1_StcMode", "0", "DemodOfdmaMap_F1_UL_Z1_B1_SubchannelInterval", "1", "DemodOfdmaMap_F1_UL_Z1_B1_SubchannelOffset", "0", "DemodOfdmaMap_F1_UL_Z1_B1_SymbolInterval", "3", "DemodOfdmaMap_F1_UL_Z1_B1_SymbolOffset", "0", "DemodOfdmaMap_F1_UL_Z1_Count", "1", "DemodOfdmaMap_F1_UL_Z1_Gap", "0", "DemodOfdmaMap_F1_UL_Z1_IDCell", "0", "DemodOfdmaMap_F1_UL_Z1_Len", "3", "DemodOfdmaMap_F1_UL_Z1_Locked", "FALSE", "DemodOfdmaMap_F1_UL_Z1_Name", "unnamed", "DemodOfdmaMap_F1_UL_Z1_SymOffset", "0", "DemodOfdmaMap_F1_UL_Z1_WrapType", "1", "DemodOfdmaMap_F1_UL_Z1_ZoneType", "0", "DemodOfdmaMap_Name", "DefaultMap", "DemodOfdmaMap_RefreshMap", "TRUE"
State Saved	Saved in instrument state.
Initial S/W Revision	Prior to A.02.00

---

### Key Definition

Basically a key requires the following syntax.

(1)Whole Map

(2)Optional header “DemodOfdmaMap” and keyname shown in the following table connected with an underscore.

(3)[DemodOfdmaMap\_{MAPKEY}]

(4)Example:

(5)DemodOfdmaMap\_Name

(6)RefreshMap

(7)Zone Count

(8)Optional header “DemodOfdmaMap”, a frame # preceded with “F”, “DL” or “UL” and keyname “Count” connected with an underscore.

(9)[DemodOfdmaMap\_]Ff\_DL\_{MAPKEY}

(10)Example:

(11)DemodOfdmaMap\_F1\_DL\_Count

(12)F1\_UL\_Count

(13)Zone Parameters

(14)Optional header “DemodOfdma”, a frame # preceded with “F”, “DL” or “UL”, a zone # preceded by “Z”, and a key name shown in the following table connected with underscores.

(15)[DemodOfdmaMap\_]Ff\_DL\_Zz\_{ZONEKEY}

(16)Example:

(17)DemodOfdmaMap\_F1\_DL\_Z2\_SymOffset



(18)F1\_UL\_Z1\_ZoneType

(19)Burst Parameters

(20)Optional header “DemodOfdma”, a frame # preceded with “F”, “DL” or “UL”, a zone # preceded by “Z”, a burst # preceded by “B” and a key name shown in the following table connected with underscores.

(21)[DemodOfdmaMap\_]Ff\_DL\_Zz\_Bb\_{ZONEKEY}

(22)Example:

(23)DemodOfdmaMap\_F1\_DL\_Z2\_B4\_SymbolOffset

(24)F1\_UL\_Z1\_B1\_BurstType

### Summary of Key Types

Whole Map			
Key	Type	Description	Remarks
AutoDetect	Boolean	Specifies if the map is auto detected or not. If this parameter is true, the measurement engine will demodulate each burst while detecting its modulation scheme. If false, each burst is demodulated based on the ModType value of each burst.	
Count	Integer	Number of frames.	1
DownlinkRatio	Floating Point	Downlink ratio of the TDD frame.	Downlink Ratio is set by the mode parameter.
FrameLen	Floating Point	Frame length.	Frame length is set by the mode parameter.
Name	String	Map Name.	
Downlink/Uplink Zone Count			
Count	Integer	Number of zones.	
Downlink/Uplink Zone			
Active	Boolean	Denotes if the zone is active.	
AmcType	Integer (Enum)	AMC slot type for AMC zone. This is available only when ZoneType. 0 ... (2,3) 1 ... (1,6) 2 ... (4,2) 3 ... (3,2)	(2,3)
Count	Integer	Number of bursts.	
IDCell	Integer	Cell ID of the zone. If IDCellCouple is false, Cell ID is determined by this parameter.	Z1 (Zone# 1) ignores this parameter.
IDCellCouple	Boolean	Determines if Cell ID is calculated from	Z1 (Zone#1) ignores this parameter

		Preamble Index. If false, ID Cell is determined by IDCell.	and regards this as always true.
Len	Integer	Zone length (in symbols).	
Locked	Boolean	If true, this zone is not editable in 89600.	This parameter is meaningful only on 89600. X-Series analyzers ignore this parameter.
Name	String	Zone Name.	This parameter is not used anywhere in X-Series analyzers.
PrbsID	Integer	PRBS ID.	
SymOffset	Integer	Symbol Offset from the start of the frame.	
UseAllSc	Boolean	Denotes if All Subcarrier is displayed or not. If false, inactive subcarriers' RCEs are returned as zero.	
WrapType	Integer (Enum)	Denotes Wrap Type (subchannel direction or symbol direction). 0 ... Subchannel 1 ... Symbol	
ZoneType	Integer (Enum)	Zone Type. Downlink: 0 ... PUSC 1 ... AMC 2 ... FUSC 3 ... OFUSC Uplink: 0 ... PUSC 1 ... OPUSC 2 ... AMC	
Downlink/Uplink Burst			
Active	Boolean	Denotes if this burst is a target of measurement or not.	
AllocType	Integer (Enum)	Burst allocation type. 0 ... Rectangle 1 ... Wrapped	
Boost	Floating Point	Boosting level of the burst in dB.	
BurstType	Integer (Enum)	Burst Type. Downlink 0 ... Normal 1 ... FCH 2 ... DLMAP Uplink 0 ... Normal	

		1 ... CDMA 2 ... PAPR 3 ... FFB
ColorIndex	Integer	An index for the color of the burst map view or measurement displays. 0 – 81.
ModType	Integer (Enum)	Modulation type of the burst. This is available only when DemodOfdmaMap_AutoDetected is false. 0 ... 16QAM 2 ... 64QAM 4 ... QPSK 8 ... BPSK
Name	String	Burst Name
SubchannelInterval	Integer	Subchannel Interval for the rectangular burst. This is meaningless for the wrapped burst.
SubchannelOffset	Integer	Subchannel offset from the start of the burst.
SymbolInterval	Integer	For the rectangular burst, symbol interval of the burst. For the wrapped burst, total length of the burst.
SymbolOffset	Integer	Symbol offset from the start of the burst.



## 6 System Functions

## File

Opens a menu that enables you to access various standard and custom Windows functions. Press any other front-panel key to exit

Key Path	Front-panel key
Initial S/W Revision	Prior to A.02.00

## File Explorer

Opens the standard Windows File Explorer. The File Explorer opens in the My Documents directory for the current user.

The File Explorer is a separate Windows application, so to return to the analyzer once you are in the File Explorer, you may either:

Exit the File Explorer by clicking on the red X in the upper right corner, with a mouse

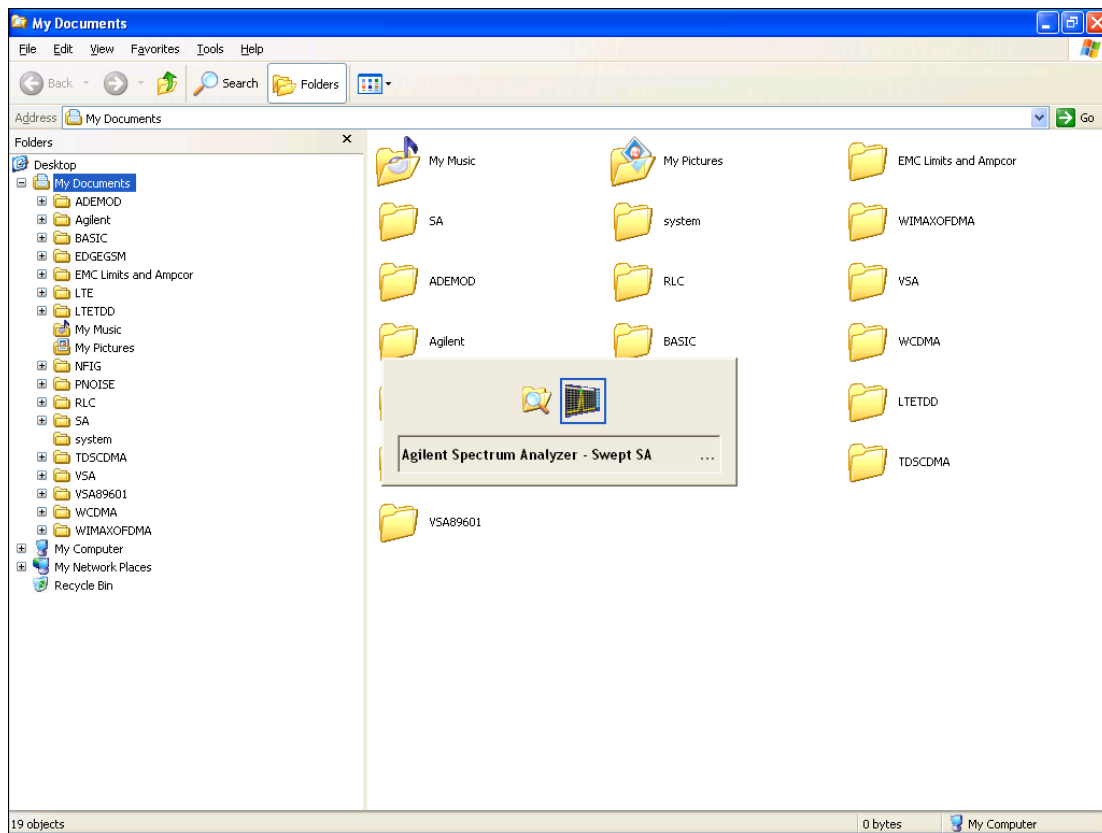

Or use Alt-Tab: press and hold the Alt key and press and release the Tab key until the Analyzer logo is showing in the window in the center of the screen, as shown above, then release the Alt key.

The ability to access File Explorer is not available if Option SF1 is installed.

Key Path	File
Initial S/W Revision	Prior to A.02.00

## Print

The Print key opens a Print dialog for configured printing (for example, to the printer of your choice). Refer to your Microsoft Windows Operating System manual for more information.

## Maximize/Restore Down

These keys allow the Instrument Application to be maximized and then restored to its prior state. Only one of the two keys is visible at a time. When not already maximized the Maximize Application key is visible, and when maximized, the Restore Down Application key is visible and replaces the Maximize Application key.

### Maximize

This key allows you to Maximize the Instrument Application, which causes the analyzer display to fill the screen. Once the application is maximized, this key is replaced by the Restore Down key.

Key Path	File
Mode	All
Notes	No equivalent remote command for this key.
State Saved	No
Initial S/W Revision	A.05.01

### Restore Down

This key allows you to Restore Down the Instrument Application and reverses the action taken by Maximize. This key is only visible when the application has been maximized, and after the Restore Down action has been completed this key is replaced by the Maximize key.

Key Path	File
Mode	All
Notes	No equivalent remote command for this key.
State Saved	No
Initial S/W Revision	A.05.01

## Page Setup

The Page Setup key brings up a Windows Page Setup dialog that allows you to control aspects of the pages sent to the printer when the PRINT hardkey is pressed.

Key Path	File
Initial S/W Revision	Prior to A.02.00

Paper size, the printer paper source, the page orientation and the margins are all settable. Just like any standard Windows dialog, you may navigate the dialog using the front-panel keys, or a mouse. There are no SCPI commands for controlling these parameters.

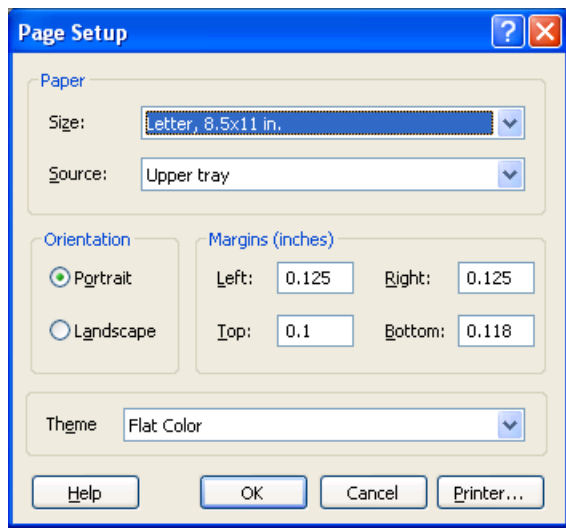

Also contained in this dialog is a drop-down control that lets you select the Theme to use when printing. For more on Themes, see information under View/Display, Display, System Display Settings, Theme. The Theme control has a corresponding SCPI command.

Parameter Name	Print Themes
Parameter Type	Enum
Mode	All
Remote Command	:SYSTem:PRINt:THEMe TDCOLOR TDMonochrome FCOLOR FMONochrome :SYSTem:PRINt:THEMe?
Example	:SYST:PRIN:THEM FCOL
Setup	:SYSTem:DEFault MISC
Preset	FCOL; not part of Preset, but is reset by Restore Misc Defaults or Restore System Defaults All and survives subsequent running of the modes.
State Saved	No
Initial S/W Revision	Prior to A.02.00

## Print

This front-panel key is equivalent to performing a File, Print, OK. It immediately performs the currently configured Print to the Default printer.



The :HCOPY command is equivalent to pressing the PRINT key. The HCOpy:ABORt command can be used to abort a print which is already in progress. Sending HCOpy:ABORt will cause the analyzer to stop sending data to the printer, although the printer may continue or even complete the print, depending on how much data was sent to the printer before the user sent the ABORt command.

Key Path	Front-panel key
<b>Remote Command</b>	:HCOPY[:IMMediate]
Initial S/W Revision	Prior to A.02.00

Key Path	SCPI command only
<b>Remote Command</b>	:HCOpy:ABORt
Initial S/W Revision	Prior to A.02.00

## Maximize

This key allows you to Maximize the Instrument Application, which causes the analyzer display to fill the screen. Once the application is maximized, this key is replaced by the Restore Down key.

Key Path	File
Mode	All
Notes	No equivalent remote command for this key.
State Saved	No
Initial S/W Revision	A.05.01

## Minimize

The Minimize key causes the analyzer display to disappear down into the task bar, allowing you to see the

Windows Desktop. You can use Alt-Tab (press and hold the Alt  key and press and release the Tab key) to restore the analyzer display.

Key Path	File
Mode	All
Notes	No equivalent remote command for this key.
State Saved	No
Initial S/W Revision	A.05.01

## Exit

This key, when pressed, will exit the Instrument Application. A dialog box is used to confirm that you intended to exit the application:

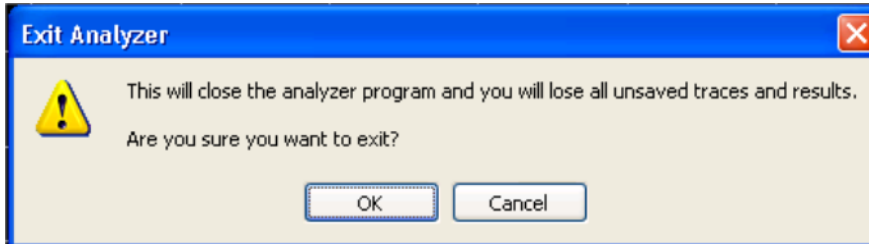

---

Key Path	File
Mode	All
Notes	The Instrument Application will close. No further SCPI commands can be sent. Use with caution!
Initial S/W Revision	Prior to A.02.00

---

## Print

This front-panel key is equivalent to performing a File, Print, OK. It immediately performs the currently configured Print to the Default printer.

The `:HCOPY` command is equivalent to pressing the PRINT key. The `HCOPY:ABORT` command can be used to abort a print which is already in progress. Sending `HCOPY:ABORT` will cause the analyzer to stop sending data to the printer, although the printer may continue or even complete the print, depending on how much data was sent to the printer before the user sent the `ABORT` command.

Key Path	Front-panel key
<b>Remote Command</b>	<code>:HCOPY[:IMMEDIATE]</code>
Initial S/W Revision	Prior to A.02.00
<hr/>	
Key Path	SCPI command only
<b>Remote Command</b>	<code>:HCOPY:ABORT</code>
Initial S/W Revision	Prior to A.02.00

## System

Opens a menu of keys that access various configuration menus and dialogs.

Key Path	Front-panel key
Notes	No remote command for this key specifically.
Initial S/W Revision	Prior to A.02.00

## Show

Accesses a menu of choices that enable you to select the information window you want to view.

Key Path	System
Mode	All
Remote Command	:SYSTem:SHOW OFF   ERRor   SYSTem   HARDware   LXI   HWSTatistics   ALIGNment   SOFTware   CAPplication  :SYSTem:SHOW?
Example	:SYST:SHOW SYST
Notes	This command displays (or exits) the various System information screens.
Preset	OFF
State Saved	No
Range	OFF  ERRor   SYSTem   HARDware   LXI   HWSTatistics   ALIGNment   SOFTware CAPplication
Initial S/W Revision	Prior to A.02.00

## Errors

There are two modes for the Errors selection, History and Status.

The list of errors displayed in the Errors screen does not automatically refresh. You must press the Refresh key or leave the screen and return to it to refresh it.

History brings up a screen displaying the event log in chronological order, with the newest event at the top. The history queue can hold up to 100 messages (if a message has a repeat count greater than 1 it only counts once against this number of 100). Note that this count bears no relation to the size of the SCPI queue. If the queue extends onto a second page, a scroll bar appears to allow scrolling with a mouse. Time is displayed to the second.

Status brings up a screen summarizing the status conditions currently in effect. Note that the time is displayed to the second.

The fields on the Errors display are:

Type (unlabeled) - Displays the icon identifying the event or condition as an error or warning.

ID - Displays the error number.

Message - Displays the message text.

Repeat (RPT) - This field shows the number of consecutive instances of the event, uninterrupted by other events. If an event occurs 5 times with no other intervening event, the value of repeat will be 5.

If the value of Repeat is 1 the field does not display. If the value of Repeat is >1, the time and date shown are those of the most recent occurrence. If the value of repeat reaches 999,999 it stops there.

Time - Shows the most recent time (including the date) at which the event occurred.

Key Path	System, Show
Mode	All
Remote Command	:SYSTem:ERRor[:NEXT]?
Example	:SYST:ERR?
Notes	The return string has the format: “<Error Number>,<Error>” Where <Error Number> and <Error> are those shown on the Show Errors screen
Backwards Compatibility Notes	In some legacy analyzers, the Repeat field shows the number of times the message has repeated since the last time the error queue was cleared. In the X-Series, the Repeat field shows the number of times the error has repeated since the last intervening error. So the count may very well be different than in the past even for identical signal conditions  Unlike previous analyzers, in the X-Series all errors are reported through the Message or Status lines and are logged to the event queue. They never appear as text in the graticule area (as they sometimes do in previous analyzers) and they are never displayed in the settings panel at the top of the screen (as they sometimes do, by changing color, in previous analyzers).  As a consequence of the above, the user can only see one status condition (the most recently generated) without looking at the queue. In the past, at least in the Spectrum Analyzer, multiple status conditions might display on the right side of the graticule.  In general, there is no backwards compatibility specified or guaranteed between the error numbers in the X-Series and those of earlier products. Error, event, and status processing code in customers' software will probably need to be rewritten to work with X-Series.  In the legacy analyzers, some conditions report as errors and others simply turn on status bits. Conditions that report as errors often report over and over as long as the condition exists. In the X-series, all conditions report as start and stop events. Consequently, software that repeatedly queries for a condition error until it stops reporting will have to be rewritten for the X-series.
Initial S/W Revision	Prior to A.02.00

## Previous Page

See ["Next Page" on page 186](#).

Key Path	System, Show, Errors
Initial S/W Revision	Prior to A.02.00

## Next Page

Next Page and Previous Page menu keys move you between pages of the log, if it fills more than one page. These keys are grayed out in some cases:

- If on the last page of the log, the Next Page key is grayed-out
- If on the first page of the log, the Previous Page key is grayed-out.
- If there is only one page, both keys are grayed out.

Key Path	System, Show, Errors
Initial S/W Revision	Prior to A.02.00

## History

The History and Status keys select the Errors view. The Status key has a second line that shows a number in [square brackets]. This is the number of currently open status items.

Key Path	System, Show, Errors
Initial S/W Revision	Prior to A.02.00

## Verbose SCPI On/Off

When you turn Verbose SCPI on, additional information is returned when you send the :SYSTem:ERRor? query. The additional information consists of the characters that stimulated the error. This can aid you in debugging your test programs by indicating where in the parsing of a SCPI command the instrument encountered an invalid command or query.

Specifically, with Verbose SCPI on, the SYSTem:ERRor? query is expanded to show the SCPI data received, with the indicator <Err> at the point in the stream that the error occurred.

Verbose SCPI has no effect on the Show Errors screen or front panel Message Line; it only changes the response to the :SYST:ERR? query.

See the example below, where the invalid command "SENS:BOGUS" is sent:

Normal response to :SYST:ERR (using the Telnet window):

```
SCPI> SENS:BOGUS
```

```
SCPI> SYST:ERR?
```

```
-113,"Undefined header"
```

Now after turning on Verbose SCPI:

```
SCPI> SYST:BOGUS
```

```
SCPI> SYST:ERR?
```

```
-113,"Undefined header;SYST:BOGUS<Err>"
```

Key Path	System, Show, Errors
Mode	All
<b>Remote Command</b>	:SYSTem:ERRor:VERBoSe OFF ON 0 1 :SYSTem:ERRor:VERBoSe?
<b>Example</b>	:SYST:ERR:VERB ON
Preset	This is unaffected by Preset but is set to OFF on a "Restore System Defaults->Misc"
State Saved	No
Range	On   Off
Initial S/W Revision	Prior to A.02.00

### Refresh

When pressed, refreshes the Show Errors display.

Key Path	System, Show, Errors
Initial S/W Revision	Prior to A.02.00

### Clear Error Queue

This clears all errors in all error queues.

Note the following:

- Clear Error Queue does not affect the current status conditions.
- Mode Preset does not clear the error queue.
- Restore System Defaults will clear all error queues.
- \*CLS only clears the queue if it is sent remotely and \*RST does not affect any error queue.
- Switching modes does not affect any error queues.

Key Path	System, Show, Errors
Initial S/W Revision	Prior to A.02.00

### Status

See "[History](#)" on page 186.

### Input Overload Enable (Remote Command Only)

Input Overload errors are reported using the Input Overload status bit (bit 12 in the Measurement Integrity status register). Input Overloads (for example, ADC Overload errors) can come and go with great frequency, generating many error events (for example, for signals just on the verge of overload), and so are

not put into the SCPI error queue by default. Normally the status bit is the only way for detecting these errors remotely.

It is possible to enable Input Overload reporting to the SCPI queue, by issuing the :SYSTem:ERRor:OVERload ON command. To return to the default state, issue the :SYSTem:ERRor:OVERload OFF command. In either case, Input Overloads always set the status bit.

**NOTE**

For versions of firmware before A.10.01, the Input Overload was only a Warning and so was never available in the SCPI queue, although it did set the status bit. For A.10.01 and later, the Input Overload is an error and can be enabled to the SCPI queue using this command.

Key Path	SCPI only
Remote Command	:SYSTem:ERRor:OVERload[:STATe] 0 1 OFF ON
Example	:SYST:ERR:OVER 1 Enable overload errors
Preset	Set to OFF by Restore Misc Defaults (no Overload errors go to SCPI)
State Saved	Saved in instrument state.
Initial S/W Revision	A.10.01

### Power Up (Remote Command Only)

This serves to show the errors encountered during the application boot-up, such as: mismatch FW-FPGA, missing Calibration data, missing hardware and construction errors.

Remote Command	:SYSTem:ERRor:PUP?
Notes	If no error occurs, the return value will be: "No Power Up Errors." Return Value: <list of error strings>. <List of error strings> is an <IEEE488 Block> format. Return Value Example: "Power up errors, see details in Windows Event Log" "Unmatched FPGA Version(s), See details in Windows Event Log"
Initial S/W Revision	E.14.30

### System

The System screen is formatted into three groupings: product descriptive information, options tied to the hardware, and software products:



<Product Name> <Product Description>	
Product Number: N9020A	
Serial Number: US46220924	
Firmware Revision: A.01.01	
Computer Name: <hostname>	
Host ID: N9020A,US44220924	
N9020A-503	Frequency Range to 3.6 GHz
N9020A-PFR	Precision Frequency Reference
N9020A-P03	Preamp 3.6 GHz
N9060A-2FP	Spectrum Analysis Measurement Suite 1.0.0.0
N9073A-1FP	WCDMA 1.0.0.0
N9073A-2FP	WCDMA with HSDPA 1.0.0.0

The Previous Page is grayed-out if the first page of information is presently displayed. The Next Page menu key is grayed-out if the last page is information is presently displayed.

Key Path	System, Show
Mode	All
<b>Example</b>	SYST:SHOW SYST
Backwards Compatibility Notes	The hardware statistics that are displayed in the PSA Show System screen have been moved to a dedicated Show Hardware Statistics screen in the Service Menu.
Initial S/W Revision	Prior to A.02.00

### Show System contents (Remote Command Only)

A remote command is available to obtain the contents of the Show System screen (the entire contents, not just the currently displayed page).

<b>Remote Command</b>	:SYSTem:CONFigure[:SYSTem]?
<b>Example</b>	:SYST:CONF?
Notes	The output is an IEEE Block format of the Show System contents. Each line is separated with a new-line character.
Initial S/W Revision	Prior to A.02.00

### Computer System description (Remote Command Only)

A remote command is available to obtain the Computer System description. The Computer System is the operating system and patch level as reported by operating system.

<b>Remote Command</b>	:SYSTem:CSYSem?
<b>Example</b>	:SYST:CSYS?
<b>Notes</b>	The return value is the Computer System name and service pack level.
<b>Initial S/W Revision</b>	Prior to A.12.00

## Hardware

The show hardware screen is used to view details of the installed hardware. This information can be used to determine versions of hardware assemblies and field programmable devices, in the advent of future upgrades or potential repair needs.

The screen is formatted into two groupings: product descriptive information and hardware information. The hardware information is listed in a table format:

<b>Hardware Information</b>									
Agilent EXM Wireless Test Set									
Product Number: E6640A									
Serial Number: US12341234									
Instrument S/W Revision: E.14.00_R0133									
Revision Date: 1/23/2014 10:33:35 AM									
Assembly Name	Part #	Serial #	Matl Rev	Rev	OF Rev	Hw Id	Cal Date	Cal Interval	Misc
Reference	M9300A	MY53000146				0165			
Reference Carrier	M9300A	W1312-63281-23-1306-00076		01	1.2.1	0166			
Reference Plugin	M9300A	W1312-63386-30-1306-00038		01	1.3.0	0167			
Wideband Digitizer	M943063005	111111111111	001	0	0	138			
Downconverter	M943063006	111111111111	001	0	A	139			
RFIO	M943063009	111111111111	001	0	A	140			
Power Supply	M943063002	111111111111	001	0	A	141			
M9430 TRX	1234567890	SN12344321	0	0	0	142	2013.10.02	2 years	
Baseband Generator	M943063007	111111111111	002	0	0	136			
ModulatorSrcOutput	M943063008	111111111111	001	0	A	137			

M9420A:

Keysight - Slot 6 - IQ Analyzer - Complex Spectrum (Prototype - Limited Sale Allowed)

RF 50 Ω AC SENSE:INT RF OFF ALIGN 02:37:24 AM Apr 20, 2015

**Reference Level 0.00 dBm** Center Freq: 1.000000000 GHz  
 Trig: Free Run Avg|Hold:>25/25  
 Range: 0 dBm

**Hardware Information**  
 Keysight CANNON\_XXXX PXIe Vector Transceiver  
 Product Number: M9420A  
 Serial Number: CN00000302  
 Instrument S/W Revision: M.16.25\_P0002  
 Revision Date: 4/2/2015 5:17:50 PM

Assembly Name	Part #	Serial #	Matl Rev	Rev	OF Rev	Hw Id	Cal Date
PXIe Controller	M9037A			0		174	
Wideband Digitizer	M943063005	0031000000	004	11	0	138	
Downconverter	M942063001	111111111111	001	11	A	139	
RFIO	M942063002	07900000000	002	0	A	175	
Power Supply	M943063002	07900000000	004	0	A	141	
(M9420A TRX)	1234567890	CN00000302	0	0	0	142	1970.01
M9420A MINID			0	0	0	0	
Baseband Generator	M943063007	0031000000	005	11	0	136	
ModulatorSrcOutput	M942063003	79144201445	001	11	A	137	

The Previous Page is grayed-out if the first page of information is presently displayed. The Next Page menu key is grayed-out if the last page of information is presently displayed.

Key Path	System, Show
Mode	All
Example	SYST:SHOW HARD
Initial S/W Revision	Prior to A.02.00

### System Remote Commands (Remote Commands Only)

The commands in this section have no front-panel key equivalent.

"System Powerdown (Remote Command Only)" on page 192

"System Log Off (Remote Command Only)" on page 192

"List installed Options (Remote Command Only)" on page 192

"Lock the Front-panel keys (Remote Command Only)" on page 192

"Front Panel activity history (Remote Command only)" on page 193

"SCPI Version Query (Remote Command Only)" on page 195

"Date (Remote Command Only)" on page 195

"Time (Remote Command Only)" on page 195

Initial S/W Revision	Prior to A.02.00
----------------------	------------------

### System Powerdown (Remote Command Only)

<b>Remote Command</b>	<code>SYSTem:PDOWn [NORMal   FORCe]</code>
<b>Notes</b>	Shuts down the instrument in the normal way (NORMal) or forced way (FORCe). In case there is another application with modified data pending for saving, the application prompt the user. The system waits until the user responds in the normal mode. It will go off after 20 seconds of wait in the force mode and all data will be lost.

### System Log Off (Remote Command Only)

This SCPI command provides a means to terminate all open Windows applications and log off the current user. This is equivalent to performing the Windows command “shutdown -l -f -t0”.

<b>Remote Command</b>	<code>SYSTem:LOFF</code>
<b>Example</b>	<code>SYST:LOFF</code>
<b>Notes</b>	Initiates an immediate log off of the current user. This exits the instrument application, thus any unsaved measurement result will be lost. You cannot use *WAI or *OPC? to synchronize operation. In addition to the instrument application, all other Windows programs will be terminated without the opportunity to save any work in progress. The instrument will require human interaction to perform a Log In to regain instrument operation.
<b>Initial S/W Revision</b>	A.14.50

### List installed Options (Remote Command Only)

Lists the installed options that pertain to the instrument (signal analyzer).

<b>Mode</b>	All
<b>Remote Command</b>	<code>:SYSTem:OPTions?</code>
<b>Example</b>	<code>:SYST:OPT?</code>
<b>Notes</b>	The return string is a comma separated list of the installed options. For example: “503,P03,PFR” <code>:SYSTem:OPTions?</code> and <code>*OPT?</code> are the same.
<b>State Saved</b>	No
<b>Initial S/W Revision</b>	Prior to A.02.00

### Lock the Front-panel keys (Remote Command Only)

Disables the instrument keyboard to prevent local input when the instrument is controlled remotely. Annunciation showing a “K” for “Klock” (keyboard lock) alerts the local user that the keyboard is locked. Klock is similar to the GPIB Local Lockout function; namely that no front-panel keys are active with the

exception of the Power Standby key. (The instrument is allowed to be turned-off if Klock is ON.) The Klock command is used in remote control situations where Local Lockout cannot be used.

Although primary intent of Klock is to lock-out the front panel, it will lock-out externally connected keyboards through USB. Klock has no effect on externally connected pointing devices (mice).

The front panel 'Local' key (Cancel/Esc) has no effect if Klock is ON.

Mode	All
<b>Remote Command</b>	:SYSTem:KLOCK OFF ON 0 1 :SYSTem:KLOCK?
<b>Example</b>	:SYST:KLOC ON
Notes	Keyboard lock remains in effect until turned-off or the instrument is power-cycled
Preset	Initialized to OFF at startup, unaffected by Preset
State Saved	No
Initial S/W Revision	Prior to A.02.00

### Front Panel activity history (Remote Command only)

Instrument front panel usage can be monitored with the query :SYSTEM:METRICS:FPANEL?. The monitoring occurs for front panel Hardkey or Softkey operation (not mouse or touch operation on instruments with Multi-Touch User Interface). The information of the usage pertains to the activity since the instrument application was started; the information does not persist after the application is terminated, or the instrument has been rebooted.

To prevent the front panel from being placed into Remote the monitoring must occur via an I/O protocol such as LAN Socket, or the remote program performing the monitoring must explicitly place the instrument into Local after the query has been performed.

<b>Remote Command</b>	:SYSTem:METRICS:FPANEL?
<b>Example</b>	SYST:METR:FPAN?
Notes	The return value is a string with the format "YYYY-MM-DD<space>HH:MM:SS", in instrument local time.  If no front panel activity has occurred since the instrument was booted (instrument application started), the return value will be the time the instrument application started. The instrument application start time can be obtained with the query SYSTem:METRICS:STIME?
Initial S/W Revision	x.16.10

### SCPI activity history (Remote Command only)

Instrument remote operation usage via SCPI can be monitored with the query :SYSTEM:METRICS:SCPI?. The monitoring occurs for SCPI control from any I/O channel (GPIB, USB, or LAN). The information of the usage pertains to the activity since the instrument application was started; the information does not persist after the application is terminated, or the instrument has been rebooted.

<b>Remote Command</b>	:SYSTem:METRics:SCPI?
<b>Example</b>	:SYST:METR:SCPI?
<b>Notes</b>	<p>The return value is a string with the format “YYYY-MM-DD&lt;space&gt;HH:MM:SS”, in instrument local time.</p> <p>The following commands are excluded from the history accounting:</p> <ul style="list-style-type: none"> <li>*IDN?</li> <li>*OPT?</li> <li>:SYSTem:DATE?</li> <li>:SYSTem:TIME?</li> <li>:SYSTem:PON:TIME?</li> </ul> <p>Queries in the :SYSTem:ERRor subsystem          Queries in the :SYSTem:LKEY subsystem          Queries in the :SYSTem:METRics subsystem          Queries in the :SYSTem:MODule subsystem</p> <p>If no SCPI activity has occurred since the instrument was booted (instrument application started), the return value will be the time the instrument application started. The instrument application start time can be obtained with the query SYSTem:METRics:STIME?</p>
<b>Initial S/W Revision</b>	x.16.10

### Instrument start time (Remote Command only)

To determine if instrument activity has occurred the SCPI query :SYSTem:METRics:STIME? can be used to determine the instrument application start time.

<b>Remote Command</b>	:SYSTem:METRics:STIME?
<b>Example</b>	:SYST:METR:STIM?
<b>Notes</b>	<p>The return value is a string with the format “YYYY-MM-DD&lt;space&gt;HH:MM:SS”, in instrument local time.</p>
<b>Initial S/W Revision</b>	x.16.10

### List SCPI Commands (Remote Command Only)

Outputs a list of the valid SCPI commands for the currently selected Mode.

<b>Remote Command</b>	:SYSTem:HELP:HEADers?
<b>Example</b>	:SYST:HELP:HEAD?
<b>Notes</b>	<p>The output is an IEEE Block format with each command separated with the New-Line character (hex 0x0A)</p>
<b>Initial S/W Revision</b>	Prior to A.02.00

### SCPI Version Query (Remote Command Only)

Returns the SCPI version number with which the instrument complies. The SCPI industry standard changes regularly. This command indicates the version used when the instrument SCPI commands were defined.

<b>Remote Command</b>	:SYSTem:VERSion?
<b>Example</b>	:SYST:VERS?
Initial S/W Revision	Prior to A.02.00

### Date (Remote Command Only)

The recommended access to the Date, Time, and Time zone of the instrument is through the Windows native control (Control Panel or accessing the Task Bar). You may also access this information remotely, as shown in this command and Time (below).

Sets or queries the date in the instrument.

Mode	All
<b>Remote Command</b>	:SYSTem:DATE "<year>,<month>,<day>" :SYSTem:DATE?
<b>Example</b>	:SYST:DATE "2006,05,26"
Notes	<year> is the four digit representation of year. (for example, 2006) <month> is the two digit representation of year. (for example. 01 to 12) <day> is the two digit representation of day. (for example, 01 to 28, 29, 30, or 31) depending on the month and year Unless the current account has Power User or Administrator privileges, an error will be generated by this command and no action will be taken.
Initial S/W Revision	Prior to A.02.00

### Time (Remote Command Only)

Sets or queries the time in the instrument.

Mode	All
<b>Remote Command</b>	:SYSTem:TIME "<hour>,<minute>,<second>" :SYSTem:TIME?
<b>Example</b>	:SYST:TIME "13,05,26"
Notes	<hour> is the two digit representation of the hour in 24 hour format <minute> is the two digit representation of minute <second> is the two digit representation of second Unless the current account has Power User or Administrator privileges, an error will be generated by this command and no action will be taken.
Initial S/W Revision	Prior to A.02.00

### Module Name (Remote Command Only)

Query only. This will return the name of the instance as displayed on the xSA main window.

Mode	All
<b>Remote Command</b>	:SYSTem:MODUle:NAME?
<b>Example</b>	:SYST:MOD:NAME?
Notes	The Display Name of the module will be returned. The Display name shows the location of the module with which the application is running. Display name uses format of "Chassis <number> - Slot <number>". If there is only one chassis is used, "Chassis <number> - " will be ignored, the display name will become "Slot <number>".
Preset	Not affected by Preset, reset to "Left" with Restore System Defaults Misc.
State Saved	No
Initial S/W Revision	A.13.80

### Module Index (Remote Command Only)

Query only. This will return the index of this xSA instance. This index is used as the device number in a VISA address ("hlsip#").

Mode	All
<b>Remote Command</b>	:SYSTem:MODUle:INDex?
<b>Example</b>	:SYST:MOD:IND?
Notes	The returned value is meaningless on M9420A.3.
Preset	Not affected by Preset, reset to 0 with Restore System Defaults Misc.
State Saved	No
Initial S/W Revision	A.13.80

### Module Mnemonic (Remote Command Only)

Query only. This will return the mnemonic of the instance as used in the command line "/Process:<mnemonic>" argument.

Mode	All
<b>Remote Command</b>	:SYSTem:MODUle:MNEMonic?
<b>Example</b>	:SYST:MOD:MNEM?
Notes	This will return the mnemonic of the instance as used in the command line "/Process:<mnemonic>" argument.



Preset	Not affected by Preset and Restore System Defaults Misc.
State Saved	No
Initial S/W Revision	A.13.80

### Module List (Remote Command Only)

Query only. This will return the list of defined mnemonics that can be used in the command line “/Process:<mnemonic>” argument with corresponding configuration information. The comma separated return values are: mnemonic, display name, Enabled/Disabled, VISA device id (instr# or hislip#), telnet port, socket port, Physics port, Physics configuration tag.

Mode	All
<b>Remote Command</b>	:SYSTem:MODule:LIST?
<b>Example</b>	:SYST:MOD:LIST?
Notes	Example: it returns: M9290A_US00000001,Slot 1,Enabled,0,5023,5025,3574 M9290A_US00000002,Slot 5,Enabled,1,5123,5125,3575 M9290A_US00000003,Slot 11,Enabled,2,5223,5225,3576 M9290A_US00000004,Slot 15,Enabled,3,5323,5325,3577
Preset	Not affected by Preset, reset to 0 with Restore System Defaults Misc.
State Saved	No
Initial S/W Revision	A.13.80

### Module Enable (Remote Command Only)

Query and command. The query SYST:MOD:ENAB? “<mnemonic>” returns “0” for disabled, “1” for enabled. The command SYST:MOD:ENAB “<mnemonic>” 0|1 will disable/enable the configuration.

Notes: Enabling a configuration that does not have a HW will result in run-time errors when trying to start that configuration. Trying to disable the default configuration will result in the error: -221, “Setting conflict:Cannot disable default process configuration ‘<mnemonic>”.

Example:

}

```
SCPI>>sys:mod:enab? "M9290A_US00000001"
```

```
<<1
```

```
SCPI>>sys:mod:enab? "M9290A_US00000002"
```

```
<<0
```

SCPI>>syst:err?

<<+0,"No error"

SCPI>>syst:mod:enab "M9290A\_US00000001",0

SCPI>>syst:err?

<<-221,"Settings conflict;Cannot disable default process configuration 'M9290A\_US00000001'"

Mode	All
<b>Remote Command</b>	:SYSTem:MODule:ENABle? "<mnemonic>" :SYSTem:MODule:ENABle "<mnemonic>","0 1
<b>Example</b>	:SYST:MOD:ENAB? "M9290A_US00000001" :SYST:MOD:ENAB "M9290A_US00000001",0
Preset	Not affected by Preset and Restore System Defaults Misc.
State Saved	No
Initial S/W Revision	A.13.80

### Module Default (Remote Command Only)

Query and command. The query SYST:MOD:DEF? returns the mnemonic of the default configuration. The command SYST:MOD:DEF "mnemonic" will set that configuration as the default. If the configuration was disabled, the module default command on it will enable this configuration.

Example:

SCPI>>syst:mod:def?

<<" M9290A\_US00000001"

SCPI>>syst:mod:enab "M9290A\_US00000002",0

SCPI>>syst:mod:enab? "M9290A\_US00000002"

<<0

SCPI>>syst:mod:def "M9290A\_US00000002"

SCPI>>syst:mod:enab? "M9290A\_US00000002"

<<1

SCPI>>syst:mod:def?

<<" M9290A\_US00000002"

Mode	All
<b>Remote Command</b>	:SYSTem:MODule:DEFault?

---

	:SYSTem:MODule:DEFault "<mnemonic>"
<b>Example</b>	:SYST:MOD:DEF? :SYST:MOD:DEF "M9290A_US0000001"
Preset	Not affected by Preset, reset to "Left" with Restore System Defaults Misc.
State Saved	No
Initial S/W Revision	A.13.80

---

### Module Model Number (Remote Command Only)

Query only. The query ":SYST:MODule:MODEl?" will return model number of the current module.

---

Mode	All
<b>Remote Command</b>	:SYSTem:MODule:MODEl?
<b>Example</b>	:SYSTem:MODule:MODEl?
Notes	This query will return model number. e.g. "M9420A"
Preset	Not affected by Preset,
State Saved	No
Initial S/W Revision	E.14.14

---

### Module Model Serial Number (Remote Command Only)

Query only. The query ":SYST: MODule:SERial?" will return model serial number of the current module.

---

Mode	All
<b>Remote Command</b>	:SYSTem:MODule:SERial?
<b>Example</b>	:SYSTem:MODule:SERial?
Notes	This query will return model serial number like "SN12344321"
Preset	Not affected by Preset
State Saved	No
Initial S/W Revision	E.14.14

---

### Power On

Enables you to select how the instrument should power on. The options are: Mode and Input/Output Defaults, User Preset and Last State.

#### NOTE

In products that run multiple instances of the X-Series Application, the same Power On type is shared between all the instances.

---

Key Path	System
Mode	All
<b>Remote Command</b>	:SYSTem:PON:TYPE MODE USER LAST :SYSTem:PON:TYPE?
<b>Example</b>	:SYST:PON:TYPE MODE
Preset	This is unaffected by a Preset but is set to Mode on a “Restore System Defaults->All”
State Saved	No
<b>Backwards Compatibility SCPI</b>	:SYSTem:PON:TYPE PRESet the “PRESet” parameter is supported for backward compatibility only and behaves the same as MODE.
Backwards Compatibility Notes	The Preset Type key in legacy analyzers has been removed, and the Power On toggle key has been replaced by this 1-of-N key in the System menu.
Initial S/W Revision	Prior to A.02.00

## Mode and Input/Output Defaults

When the analyzer is powered on in Mode and Input/Output Defaults, it performs a Restore Mode Defaults to all modes in the instrument and also performs a Restore Input/Output Defaults.

Persistent parameters (such as Amplitude Correction tables or Limit tables) are not affected at power on, even though they are normally cleared by Restore Input/Output Defaults and/or Restore Mode Defaults.

Key Path	System, Power On
Mode	All
<b>Example</b>	SYST:PON:TYPE MODE
Readback Text	Defaults
Initial S/W Revision	Prior to A.02.00

## User Preset

Sets Power On to User Preset. When the analyzer is powered on in User Preset, it will User Preset each mode and switch to the power-on mode. Power On User Preset will not affect any settings beyond what a normal User Preset affects.

**NOTE**

In products that run multiple instances of the X-Series Application, the same User Preset is shared between all the instances.

An instrument could never power up for the first time in User Preset.

Key Path	System, Power On
Mode	All

<b>Example</b>	SYST:PON:TYPE USER
Readback Text	User Preset
Backwards Compatibility Notes	Power On User Preset will cause the instrument to power up in the power-on mode, not the last mode the instrument was in prior to shut down. Also, Power On User Preset will User Preset all modes. This does not exactly match legacy behavior.
Initial S/W Revision	Prior to A.02.00

## Last State

Sets Power On to **Last**. When the analyzer is powered on, it will put all modes in the last state they were in prior to when the analyzer was put into Power Standby and it will wake up in the mode it was last in prior to powering off the instrument. The saving of the active mode prior to shutdown happens behind the scenes when a controlled shutdown is requested by using the front panel power Standby key or by using the remote command SYSTem:PDOWn. The non-active modes are saved as they are deactivated and recalled by Power On Last State.

### NOTE

In products that run multiple instances of the X-Series Application, each instance has a unique Last State. An instrument can never power up for the first time in Last.

If line power to the analyzer is interrupted, for example by pulling the line cord plug or by switching off power to a test rack, Power On Last State may not work properly. For proper operation, Power On Last State depends on you shutting down the instrument using the Standby key or the SYSTem:PDOWn SCPI command. This will ensure the last state of each mode is saved and can be recalled during a power up.

Key Path	System, Power On
Mode	All
<b>Example</b>	SYST:PON:TYPE LAST
Notes	Power on Last State only works if you have done a controlled shutdown prior to powering on in Last. If a controlled shutdown is not done when in Power On Last State, the instrument will power up in the last active mode, but it may not power up in the active mode's last state. If an invalid mode state is detected, a Mode Preset will occur. To control the shutdown under remote control use the :SYSTem:PDOWn command.
Readback Text	Last State
Backwards Compatibility Notes	It is no longer possible to power-up the analyzer in the last mode the analyzer was running with that mode in the preset state. (ESA/PSA SYST:PRESET:TYPE MODE with SYST:PON:PRESET) You can power-on the analyzer in the last mode the instrument was running in its last state (SYST:PON:TYPE LAST), or you can specify the mode to power-up in its preset state (SYST:PON:MODE <mode>).
Initial S/W Revision	Prior to A.02.00

## Power On Application

Accesses a menu that lists the available Modes and lets you select which Mode is to be the power-on application.

This application is used for Power On Type “Mode and Input/Output Defaults” and Restore System Defaults All.

**NOTE**

In products that run multiple instances of the X-Series Application, the same Power On Application is shared between all the instances.

<b>Key Path</b>	System, Power On
<b>Mode</b>	All
<b>Remote Command</b>	:SYSTem:PON:MODE SA   BASIC   ADEMOD   NFIGURE   PNOISE   CDMA2K   TDSCDMA   VSA   VSA89601   WCDMA   WIMAXOFDMA  :SYSTem:PON:MODE?
<b>Example</b>	SYST:PON:MODE SA
<b>Notes</b>	The list of possible modes (and remote parameters) to choose from is dependent on which modes are installed in the instrument.
<b>Preset</b>	This is unaffected by a Preset but is set on a “Restore System Defaults->All” to: SEQAN
<b>State Saved</b>	No
<b>Initial S/W Revision</b>	Prior to A.02.00

## Configure Applications

The Configure Applications utility can be used to:

- select applications for preload
- determine how many applications can fit in memory at one time
- specify the order of the Modes in the Mode menu.

This utility consists of a window with instructions, a set of “Select Application” checkboxes, a “fuel bar” style memory gauge, and keys that help you set up your configuration.

**NOTE**

In products that run multiple instances of the X-Series Application, the same Configure Applications Utility is shared between all the instances.

For more information, see the following topics:

["Preloading Applications" on page 203](#)

["Access to Configure Applications utility" on page 203](#)

["Virtual memory usage" on page 203](#)

<b>Key Path</b>	System, Power On
<b>Example</b>	:SYST:SHOW CAPP Displays the Config Applications screen
<b>Initial S/W Revision</b>	A.02.00

## Preloading Applications

During runtime, if a Mode that is not preloaded is selected using the Mode menu or sending SCPI commands, there will be a pause while the Application is loaded. During this pause a message that says “Loading application, please wait ...” is displayed. Once loaded, the application stays loaded, so the next time you select it during a session, there is no delay.

Preloading enables you to “preload” at startup, to eliminate the runtime delay. Preloading an application will cause it to be loaded into the analyzer’s memory when the analyzer program starts up. If you do this, the delay will increase the time it takes to start up the analyzer program, but this may be preferable to having to wait the first time you select an application. Note that, once an application is loaded into memory, it cannot be unloaded without exiting and restarting the analyzer program.

Note that there are more applications available for the X-Series than can fit into Windows Virtual Memory. By allowing you to choose which licensed applications to load at startup, the Configure Applications utility allows you to make optimal use of your memory.

### Access to Configure Applications utility

A version of the utility runs the first time you power up the analyzer after purchasing it from Keysight. The utility automatically configures preloads so that as many licensed applications as possible are preloaded while keeping the total estimated virtual memory usage below the limit. This auto-configuration only takes place at the very first run, and after analyzer software upgrades.

You may, at any time, manually call up the Configure Applications utility by pressing System, Power On, Configure Applications, to find a configuration that works best for you, and then restart the analyzer program.

The utility may also be called if, during operation of the analyzer, you attempt to load more applications than can fit in memory at once.

### Virtual memory usage

There are more applications available for the X-Series than can fit into memory at any one time, so the Configure Applications utility includes a memory tracker that serves two purposes:

1. It will not let you preload more applications than will fit into memory at once.
2. You can determine how many of your favorite applications can reside in memory at one time.

The utility provides a graphical representation of the amount of memory (note that the memory in question here is Virtual memory and is a limitation imposed by the operating system, not by the amount of physical memory you have in your analyzer). You select applications to preload by checking the boxes on the left. Checked applications preload at startup. The colored fuel bar indicates the total memory required when all the checked applications are loaded (either preloaded or selected during runtime).

Here is what the fuel bar colors mean:

RED: the applications you have selected cannot all fit into the analyzer’s memory. You must deselect applications until the fuel bar turns yellow.

YELLOW: the applications you have selected can all fit into the analyzer’s memory, but there is less than 10% of the memory left, probably not enough to load any other applications, either via preload or by selecting a Mode while the analyzer is running..

GREEN: The indicator is green when <90% of the memory limit is consumed. This means the applications you have selected can all fit into the analyzer's memory with room to spare. You will likely be able to load one or more other applications without running out of memory.

### Select All

Marks all applications in the selection list. This allows you to enable all applications licensed on the instrument for pre-loading, or is a convenience for selecting all applications in one operation and then letting you deselect individual applications.

---

Key Path	System, Power On, Configure Applications
Initial S/W Revision	A.02.00

---

### Deselect All

Clears the marks from all applications in the selection list, except the Power On application. The Power On application cannot be eliminated from the pre-load list.

---

Key Path	System, Power On, Configure Applications
Initial S/W Revision	A.02.00

---

### Move Up

The application list is the order that applications appear in the Mode Menu. This key enables you to shift the selected application up in the list, thus moving the selected application earlier in the Mode Menu.

---

Key Path	System, Power On, Configure Applications
Initial S/W Revision	A.02.00

---

### Move Down

The application list is the order that applications appear in the Mode Menu. This key enables you to shift the selected application down in the list, thus moving the selected application later in the Mode Menu.

---

Key Path	System, Power On, Configure Applications
Initial S/W Revision	A.02.00

---

### Select/Deselect

Toggles the currently highlighted application in the list.

---

Key Path	System, Power On, Configure Applications
Initial S/W Revision	A.02.00

---



## Save Changes and Exit

Applies the configuration of the applications list. The marked applications will be pre-loaded in memory the next time the instrument application is started, and the order of the applications in the list will be the order of the applications in the Mode Menu.

After saving your changes, the analyzer asks you if you would like it to restart so that your changes can take effect (see dialog box, below). If you choose not to restart, the changes will not take effect until the next time you shut down and restart the analyzer.

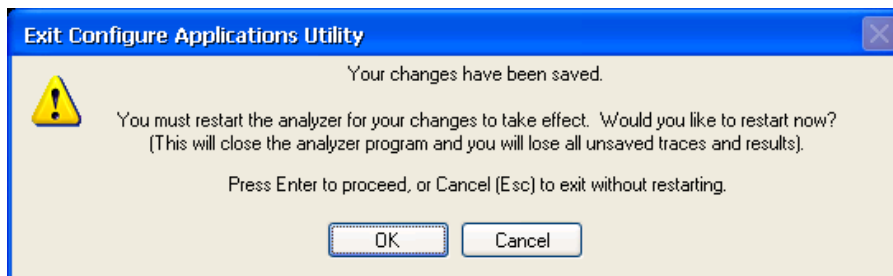

Key Path	System, Power On, Configure Applications
Remote Command	:SYSTem:PUP:PROcEss
Example	:SYST:PUP:PROc This is the SCPI command for restarting the analyzer. You must Wait after this command for the instrument application to restart
Notes	The softkey will be grayed-out when the virtual memory of the selected applications exceeds 100% of the limit.
Notes	You cannot use *WAI or *OPC? to synchronize operation after a restart. This command stops and restarts the instrument application, thus the SCPI operation is terminated and restarted. A remote program must use fixed wait time to resume sending commands to the instrument. The wait time will be dependent upon which applications are pre-loaded.
Initial S/W Revision	A.02.00
Modified at S/W Revision	A.04.00

## Exit Without Saving

Pressing this key will exit the Configure Applications utility without saving your changes.

Key Path	System, Power On, Configure Applications
Initial S/W Revision	A.02.00
Modified at S/W Revision	A.04.00

## Restore Power On Defaults

This selection causes the Power On Type and Power On Application settings to be a reset to their default values. This level of Restore System Defaults does not affect any other system settings, mode settings and

does not cause a mode switch. The Power On key, under the Restore System Defaults menu, causes the same action.

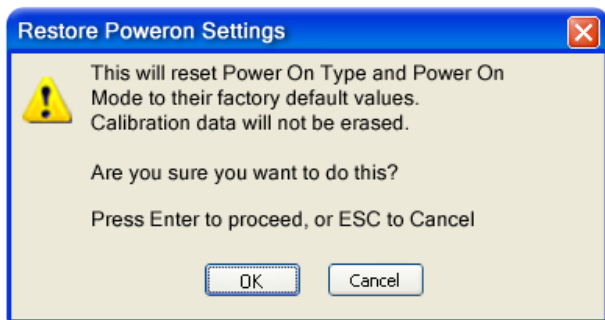

If you press any key other than OK or Enter, it is construed as a Cancel, because the only path that will actually cause the reset to be executed is through OK or Enter.

---

Key Path	System, Power On
Example	:SYST:DEF PON
Initial S/W Revision	Prior to A.02.00

---

### Configure Applications - Instrument boot-up

At start-up of the analyzer program a dialog box similar to the one under the System, Power On, Configure Applications key will be displayed allowing you to choose which licensed applications are to be loaded. This dialog will only be displayed if the memory required to pre-load all of the licensed applications exceeds the Virtual Memory available.

### Configure Applications - Windows desktop

The Configure Applications Utility may be run from the Windows Desktop. The utility is launched by double-



clicking the icon on the desktop, which brings-up a dialog box similar to the one under the System, Power On, Configure Applications key, allowing you to choose which licensed applications are to be loaded when the analyzer program starts up. This dialog box has mouse buttons on it that do the job the softkeys normally do in the System, Power On, Configure Applications menu.

**NOTE**

In products that run multiple instances of the X-Series Application, the same Configure Applications Utility launched from the Windows Desktop will apply to all the instances.

### Configure Applications - Remote Commands

The following topics provide details on using remote commands to configure the list of applications you want to load into the instrument memory or query the Virtual Memory utilization for your applications.

- "Configuration list (Remote Command Only)" on page 207
- "Configuration Memory Available (Remote Command Only)" on page 207

- "Configuration Memory Total (Remote Command Only)" on page 207
- "Configuration Memory Used (Remote Command Only)" on page 207
- "Configuration Application Memory (Remote Command Only)" on page 208

### Configuration list (Remote Command Only)

This remote command is used to set or query the list of applications to be loaded in-memory.

<b>Remote Command</b>	:SYSTem:PON:APPLication:LLISt <string of INSTRument:SElect names> :SYSTem:PON:APPLication:LLISt?
<b>Example</b>	:SYST:PON:APPL:LLIS "SA,BASIC,WCDMA"
<b>Notes</b>	<string of INSTRument:SElect names> are from the enums of the :INSTRument:SElect command. The order of the <INSTRument:SElect names> is the order that the applications are loaded into memory, and the order that they appear in the Mode Menu. Error message -225 "Out of Memory" is reported when more applications are listed than can reside in Virtual Memory. When this occurs, the existing applications load list is unchanged.
<b>Preset</b>	Not affected by Preset
<b>State Saved</b>	Not saved in instrument state
<b>Initial S/W Revision</b>	A.02.00

### Configuration Memory Available (Remote Command Only)

This remote command is used to query the amount of Virtual Memory remaining.

<b>Remote Command</b>	:SYSTem:PON:APPLication:VMEMory[:AVAIlable]?
<b>Example</b>	:SYST:PON:APPL:VMEM?
<b>Preset</b>	Not affected by Preset
<b>Initial S/W Revision</b>	A.02.00

### Configuration Memory Total (Remote Command Only)

This remote command is used to query the limit of Virtual Memory allowed for applications.

<b>Remote Command</b>	:SYSTem:PON:APPLication:VMEMory:TOTal?
<b>Example</b>	:SYST:PON:APPL:VMEM:TOT?
<b>Preset</b>	Not affected by Preset
<b>Initial S/W Revision</b>	A.02.00

### Configuration Memory Used (Remote Command Only)

This remote command is a query of the amount of Virtual Memory used by all measurement applications.

<b>Remote Command</b>	:SYSTem:PON:APPLication:VMEMory:USED?
<b>Example</b>	:SYST:PON:APPL:VMEM:USED?
<b>Preset</b>	Not affected by Preset
<b>Initial S/W Revision</b>	A.02.00

### Configuration Application Memory (Remote Command Only)

This remote command is used to query the amount of Virtual Memory a particular application consumes.

<b>Remote Command</b>	:SYSTem:PON:APPLication:VMEMory:USED:NAME? <INSTRument:SElect name>
<b>Example</b>	:SYST:PON:APPL:VMEM:USED:NAME? CDMA2K
<b>Notes</b>	<INSTRument:SElect name> is from the enums of the :INSTRument:SElect command Value returned will be 0 (zero) if the name provided is invalid.
<b>Preset</b>	Not affected by Preset
<b>Initial S/W Revision</b>	Prior to A.02.00

### Alignments

The Alignments Menu controls and displays the automatic alignment of the instrument, and provides the ability to restore the default alignment values.

The current setting of the alignment system is displayed in the system Settings Panel along the top of the display, including a warning icon for conditions that may cause specifications to be impacted.



<b>Key Path</b>	System
<b>Initial S/W Revision</b>	Prior to A.02.00

### Align Now

Accesses alignment processes that are immediate action operations. They perform complete operations and run until they are complete.

<b>Key Path</b>	System, Alignments
<b>Initial S/W Revision</b>	Prior to A.02.00

### All (Daily use)

Immediately executes an alignment of all subsystems which includes both the source and the analyzer in the TRX module. The “All” alignment is sufficient to maintain specified performance, provided that (1) the

TRX's internal temperature has not drifted more than  $\pm 5$  degree C since the previous alignment, and (2) no more than 8 hours have elapsed since the previous "All" alignment., and (3) no more than 1 week has elapsed since these three alignments have all been run: IF, RF, and Source, and (4) a 45 minute warm-up period between power-up of the TRX and invoking the "All" alignment. The instrument stops any measurement currently underway, performs the alignment, then restarts the measurement from the beginning (similar to pressing the Restart key).

If an interfering user signal is present at the RF Input, the alignment is performed on all subsystems except the RF. After completion, the Error Condition message "Align skipped: 50 MHz interference" or "Align skipped: 4.8 GHz interference" is generated. In addition the Error Condition message "Align Now, RF required" is generated, and bits 11 and 12 are set in the Status Questionable Calibration register.

The query form of the remote commands (:CALibration[:ALL]? or \*CAL?) invokes the alignment of all subsystems and returns a success or failure value. An interfering user signal is not grounds for failure; if the alignment was able to succeed on all portions but unable to align the RF because of an interfering signal, the resultant will be the success value.

Successful completion of Align Now, All will clear the "Align Now, All required" Error Condition, and clear bit 14 in the Status Questionable Calibration register. It will also begin the elapsed time counter for Last Align Now, All Time, and capture the Last Align Now, All Temperature.

If the Align RF subsystem succeeded in aligning (no interfering signal present), the elapsed time counter begins for Last Align Now, RF Time, and the temperature is captured for the Last Align Now, RF Temperature. In addition the Error Conditions "Align skipped: 50 MHz interference" and "Align skipped: 4.8 GHz interference" are cleared, the Error Condition "Align Now, RF required" is cleared, and bits 11 and 12 are cleared in the Status Questionable Calibration register

Align Now, All can be interrupted by pressing the Cancel (ESC) front-panel key or remotely with Device Clear followed by the :ABORT SCPI command. When this occurs the Error Condition message "Align Now, All required" is generated, and bit 14 is set in the Status Questionable Condition register. This is because new alignment data may be employed for an individual subsystem, but not a cohesive set of data for all subsystems.

In many cases, you might find it more convenient to change alignments to Normal, instead of executing Align Now, All. When the Auto Align process transitions to Normal, the analyzer will immediately start to update only the alignments that have expired, thus efficiently restoring the alignment process.

**NOTE**

In EXM/M9420A, Source ARB play will be turned off and the source states will not be restored after Align Now, All.

Key Path	System, Alignments, Align Now
Mode	All
Remote Command	:CALibration[:ALL] :CALibration[:ALL]?
Example	:CAL
Notes	:CALibration[:ALL]? returns 0 if successful :CALibration[:ALL]? returns 1 if failed :CALibration[:ALL]? is the same as *CAL?

---

	<p>While Align Now, All is performing the alignment, bit 0 in the Status Operation register is set. Completion, or termination, will clear bit 0 in the Status Operation register.</p> <p>This command is sequential; it must complete before further SCPI commands are processed. Interrupting the alignment from remote is accomplished by invoking Device Clear followed by the :ABORt command.</p> <p>Successful completion will clear bit 14 in the Status Questionable Calibration register.</p> <p>An interfering user signal is not grounds for failure of Align Now, All. However, bits 11 and 12 are set in the Status Questionable Calibration register to indicate Align Now, RF is required.</p> <p>An interfering user supplied signal will result in the instrument requiring an Align Now, RF with the interfering signal removed.</p>
Couplings	<p>Initializes the time for the Last Align Now, All Time.</p> <p>Records the temperature for the Last Align Now, All Temperature.</p> <p>If Align RF component succeeded, initializes the time for the Last Align Now, RF Time.</p> <p>If Align RF component succeeded, records the temperature for the Last Align Now, RF Temperature.</p>
Status Bits/OPC dependencies	<p>Bits 11, 12, or 14 may be set in the Status Questionable Calibration register.</p>
Initial S/W Revision	<p>Prior to A.02.00</p>

---

Mode	All
Remote Command	*CAL?
Example	*CAL?
Notes	<p>*CAL? returns 0 if successful</p> <p>*CAL? returns 1 if failed</p> <p>:CALibration[:ALL]? is the same as *CAL?</p> <p>See additional remarks described with :CALibration[:ALL]?</p> <p>Everything about :CALibration[:ALL]? is synonymous with *CAL? including all conditions, status register bits, and couplings</p>
Initial S/W Revision	Prior to A.02.00

---

Mode	All
Remote Command	:CALibration[:ALL]:NPENding
Example	CAL:NPEN
Notes	<p>:CALibration[:ALL]:NPENding is the same as :CALibration[:ALL] including all conditions, status register bits, except this scpi command does not BLOCK the scpi session, so the user should use status register bits to query if the calibration is successfully completed or not.</p> <p>Typical usage is:</p> <ol style="list-style-type: none"> <li>1) :CALibration:ALL:NPENding (Start a calibration)</li> <li>2) :STATus:OPERation:CONDition? (Check if the calibration is completed or not, If bit 0 is set, then the system is doing calibration, the user should repeat this scpi query until the bit is cleared )</li> </ol>

---

---

3):STATus:QUEStionable:CALibration:CONDition? (Check if there are any errors/failures in previous calibration procedure)

---

Initial S/W Revision X.14.20

---

## All but RF

Immediately executes an alignment of all subsystems except the RF subsystem which includes both the source and the analyzer in the TRX module. The instrument will stop any measurement currently underway, perform the alignment, and then restart the measurement from the beginning (similar to pressing the Restart key). This can be used to align portions of the instrument that are not impacted by an interfering user input signal.

This operation might be chosen instead of All if you do not want the device under test to experience a large change in input impedance, such as a temporary open circuit at the analyzer input.

The query form of the remote commands (:CALibration:NRF?) will invoke the alignment and return a success or failure value.

Successful completion of Align Now, All but RF will clear the “Align Now, All required” Error Condition, and clear bit 14 in the Status Questionable Calibration register. If “Align Now, All required” was in effect prior to executing the All but RF, the Error Condition message “Align Now, RF required” is generated and bit 12 in the Status Questionable Calibration register is set. It will also begin the elapsed time counter for Last Align Now, All Time, and capture the Last Align Now, All Temperature.

Align Now, All but RF can be interrupted by pressing the Cancel (ESC) front-panel key or remotely with Device Clear followed by the :ABORt SCPI command. When this occurs the Error Condition message “Align Now, All required” is generated, and bit 14 is set in the Status Questionable Condition register. This is because new alignment data may be used for an individual subsystem, but not a full new set of data for all subsystems.

### NOTE

In EXM/M9420A, Source ARB play will be turned off and the source states will not be restored after Align Now, All but RF.

---

Key Path	System, Alignments, Align Now
Mode	All
Remote Command	:CALibration:NRF :CALibration:NRF?
Example	:CAL:NRF
Notes	:CALibration:NRF? returns 0 if successful :CALibration:NRF? returns 1 if failed While Align Now, All but RF is performing the alignment, bit 0 in the Status Operation register is set. Completion, or termination, will clear bit 0 in the Status Operation register. This command is sequential; it must complete before further SCPI commands are processed. Interrupting the alignment from remote is accomplished by invoking Device Clear followed by the :ABORt command. Successful completion will clear bit 14 in the Status Questionable Calibration register and set bit 12

---

	if invoked with “Align Now, All required”.
Couplings	Initializes the time for the Last Align Now, All Time. Records the temperature for the Last Align Now, All Temperature.
Status Bits/OPC dependencies	Bits 12 or 14 may be set in the Status Questionable Calibration register.
Initial S/W Revision	Prior to A.02.00
Mode	All
Remote Command	:CALibration:NRF:NPENding
Example	CAL:NRF:NPEN
Notes	:CALibration:NRF:NPENding is the same as :CALibration:NRF including all conditions, status register bits, except that this scpi command does not BLOCK the scpi session, so the user should use status register bits to query if the calibration is successfully completed or not. Typical usage is: 1):CALibration:NRF:NPENding (start theAll but RF calibration) 2):STATus:OPERation:CONDition? (If bit 0 is set, then the system is doing calibration, the user should do re-query until this bit is cleared ) 3):STATus:QUESTionable:CALibration:CONDition? ( to check if there are any errors/failures in previous calibration procedure)
Initial S/W Revision	X.14.20

### RF (Weekly use)

Immediately executes an alignment of the RF subsystem which includes both the source and the analyzer in the TRX module . The instrument stops any measurement currently underway, performs the alignment, then restarts the measurement from the beginning (similar to pressing the Restart key).

This alignment corrects slow-rate drift which does not impair specifications for time periods shorter than one week. Thus, it is required to perform this alignment on a weekly basis to maintain specifications. This alignment typically takes >2 minutes to complete.

This operation might be desirable if the alignments had been set to not include RF alignments, or if previous RF alignments could not complete because of interference which has since been removed.

If an interfering user signal is present at the RF Input, the alignment will terminate and generate the Error Condition message “Align skipped: 50 MHz interference” or “Align skipped: 4.8 GHz interference”, and Error Condition “Align Now, RF required”. In addition, bits 11 and 12 will be set in the Status Questionable Calibration register.

The query form of the remote commands (:CALibration:RF?) will invoke the alignment of the RF subsystem and return a success or failure value. An interfering user signal is grounds for failure.



Successful completion of Align Now, RF will begin the elapsed time counter for Last Align Now, RF Time, and capture the Last Align Now, RF Temperature.

Align Now, RF can be interrupted by pressing the Cancel (ESC) front-panel key or remotely with Device Clear followed by the :ABORT SCPI command. When this occurs, the Error Condition message “Align Now, RF required” is generated, and bit 12 is set in the Status Questionable Condition register. None of the new alignment data is used.

**NOTE**

In EXM/M9420A, Source ARB play will be turned off and the source states will not be restored after Align Now, All but RF.

<b>Key Path</b>	System, Alignments, Align Now
<b>Mode</b>	All
<b>Remote Command</b>	:CALibration:RF :CALibration:RF?
<b>Example</b>	:CAL:RF
<b>Notes</b>	:CALibration:RF? returns 0 if successful :CALibration:RF? returns 1 if failed (including interfering user signal) While Align Now, RF is performing the alignment, bit 0 in the Status Operation register is set. Completion, or termination, will clear bit 0 in the Status Operation register. This command is sequential; it must complete before further SCPI commands are processed. Interrupting the alignment from remote is accomplished by invoking Device Clear followed by the :ABORT command. Successful completion clears the Error Conditions “Align skipped: 50 MHz interference” and “Align skipped: 4800 MHz interference” and the Error Conditions “Align RF failed” and “Align Now, RF required”, and clears bits 3, 11, and 12 in the Status Questionable Calibration register. A failure encountered during alignment will generate the Error Condition message “Align RF failed” and set bit 3 in the Status Questionable Calibration register. An interfering user signal will result in bits 11 and 12 to be set in the Status Questionable Calibration register to indicate Align Now, RF is required. An interfering user supplied signal will result in the instrument requiring an Align Now, RF with the interfering signal removed.
<b>Couplings</b>	Initializes the time for the Last Align Now, RF Time. Records the temperature for the Last Align Now, RF Temperature.
<b>Status Bits/OPC dependencies</b>	Bits 11, 12, or 14 may be set in the Status Questionable Calibration register.
<b>Initial S/W Revision</b>	Prior to A.02.00

<b>Mode</b>	All
<b>Remote Command</b>	:CALibration:RF:NPENding
<b>Example</b>	CAL:RF:NPEN
<b>Notes</b>	:CALibration:RF:NPENding is the same as :CALibration:RF including all conditions, status register bits, except that this scpi command does not BLOCK the scpi

session, so the user should use status register bits to query if the calibration is successfully completed or not.

Typical usage is:

- 1):CALibration:RF:NPENding (Start a RF calibration)
- 2):STATus:OPERation:CONDition? (If bit 0 is set, then the system is doing calibration, the user should do re-query until this bit is cleared )
- 3):STATus:QUEStionable:CALibration:CONDition? ( to check if there are any errors/failures in previous calibration procedure)

---

Initial S/W Revision X.14.20

---

### Source (Weekly use)

Accesses source alignment processes that are immediate action operations. They perform complete operations and run until they are complete.

Immediately executes an IQ alignment, and power level alignment. The instrument stops any sequence of the source, performs the alignment, then restarts the sequence from the beginning.

This alignment corrects slow-rate drift which does not impair specifications for time periods shorter than one week. Thus, it is required to perform this alignment on a weekly basis to maintain specifications. This alignment typically takes >2 minutes to complete.

There is no alert available for the source alignment. The operators have the responsibility to check temperature shift since last Align Now, Source to determine if the source alignment needs to be executed.

---

Key Path	System, Alignments, Align Now
Mode	All
Remote Command	:CALibration:INTernal:SOURce[:ALL] :CALibration:INTernal:SOURce[:ALL]?
Example	:CAL:INT:SOUR
Notes	:CAL:SOUR? Initiates an Alignment and returns 0 if successful :CAL:SOUR? Initiates an Alignment and returns 1 if failed
Couplings	Initializes the time for the Last Align Source Now, All Time. Records the temperature for the Last Align Source Now, All Temperature.
Initial S/W Revision	A.05.00

---

Mode	All
Remote Command	:CALibration:INTernal:SOURce[:ALL]:NPENding
Example	CAL:INT:SOUR:NPEN
Notes	:CALibration:INTernal:SOURce[:ALL]:NPENding is the same as :CALibration:INTernal:SOURce[:ALL] including all conditions, status register bits, except that this scpi command does not BLOCK the scpi session, so the user should use status register bits to query if the calibration is successfully

---

completed or not.

Typical usage is:

1):CALibration:INTernal:SOURce:NPending (start an internal source calibration)

2):STATus:OPERation:CONDition? (Check if the calibration is completed or not, If bit 0 is set, then the system is doing calibration, the user should repeat this scpi query until the bit is cleared )

3):STATus:QUESTionable:CALibration:EXTended:FAILure:CONDition? (Check if bit 14 is set or not. If this bit is set, that means there are some errors in previous internal source calibration)

Initial S/W Revision X.14.20

## Show Alignment Statistics

Shows alignment information you can use to ensure that the instrument is operating in a specific manner. The Show Alignment Statistics screen is where you can view time and temperature information.

Values which are displayed are only updated when the Show Alignment Statistics screen is invoked, they are not updated while the Show Alignment Statistics screen is being displayed. The remote commands that access this information obtain current values.

An example of the Show Alignment Statistics screen would be similar to:

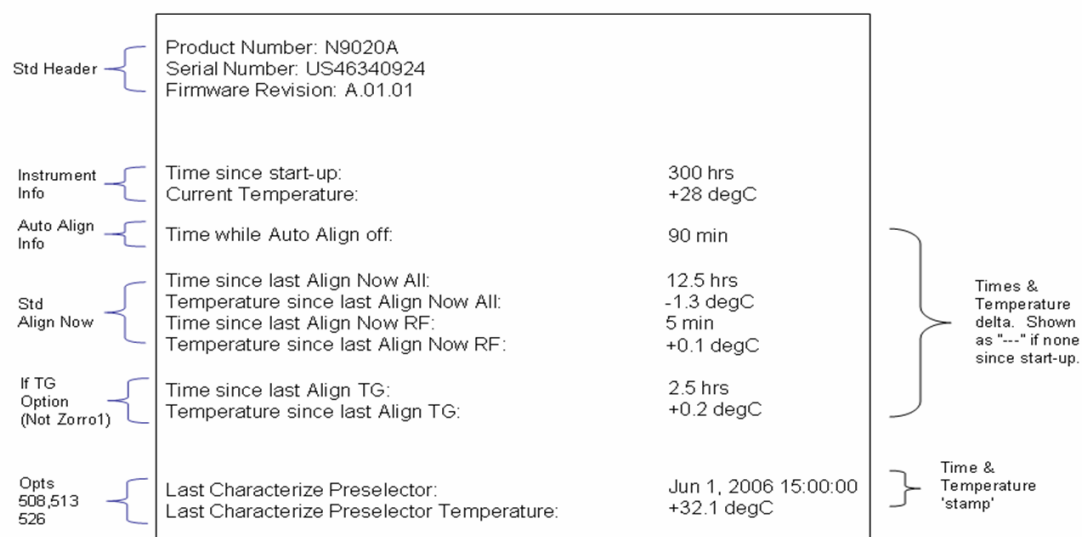

A successful Align Now, RF will set the Last Align RF temperature to the current temperature, and reset the Last Align RF time. A successful Align Now, All or Align Now, All but RF will set the Last Align Now All temperature to the current temperature, and reset the Last Align Now All time. A successful Align Now, All will also reset the Last Align RF items if the RF portion of the Align Now succeeded.

Key Path	System, Alignments
Mode	All
Notes	The values displayed on the screen are only updated upon entry to the screen and not updated while

	the screen is being displayed.
Initial S/W Revision	Prior to A.02.00

Key Path	Visual annotation in the Show Alignment Statistics screen
Mode	All
<b>Remote Command</b>	:SYSTem:PON:TIME?
<b>Example</b>	:SYST:PON:TIME?
Notes	Value is the time since the most recent start-up in seconds.
State Saved	No
Initial S/W Revision	Prior to A.02.00

Key Path	Visual annotation in the Show Alignment Statistics screen
Mode	All
<b>Remote Command</b>	:CALibration:TEMPerature:CURRent?
<b>Example</b>	:CAL:TEMP:CURR?
Notes	Value is in degrees Centigrade. Value is invalid if using default alignment data (Align Now, All required)
State Saved	No
Initial S/W Revision	Prior to A.02.00

Key Path	Visual annotation in the Show Alignment Statistics screen
Mode	All
<b>Remote Command</b>	:CALibration:TIME:LALL?
<b>Example</b>	:CAL:TIME:LALL?
Notes	Value is the elapsed time, in seconds, since the last successful Align Now, All or Align Now, All but RF was executed.
State Saved	No
Initial S/W Revision	Prior to A.02.00

Key Path	Visual annotation in the Show Alignment Statistics screen
Mode	All
<b>Remote Command</b>	:CALibration:TEMPerature:LALL?
<b>Example</b>	:CAL:TEMP:LALL?
Notes	Value is in degrees Centigrade at which the last successful Align Now, All or Align Now, All but RF

	was executed.
State Saved	No
Initial S/W Revision	Prior to A.02.00

Key Path	Visual annotation in the Show Alignment Statistics screen
Mode	All
<b>Remote Command</b>	:CALibration:TIME:LRF?
<b>Example</b>	:CAL:TIME:LRF?
Notes	Value is the elapsed time, in seconds, since the last successful Align Now, RF was executed, either individually or as a component of Align Now, All.
State Saved	No
Initial S/W Revision	Prior to A.02.00

Key Path	Visual annotation in the Show Alignment Statistics screen
Mode	All
<b>Remote Command</b>	:CALibration:TEMPerature:LRF?
<b>Example</b>	:CAL:TEMP:LRF?
Notes	Value is in degrees Centigrade at which the last successful Align Now, RF was executed, either individually or as a component of Align Now, All.
State Saved	No
Initial S/W Revision	Prior to A.02.00

Key Path	SCPI Only
Mode	All
<b>Remote Command</b>	:CALibration:TIME:LIF?
<b>Example</b>	:CAL:TIME:LIF?
Notes	Value is the elapsed time, in seconds, since the last successful Align IF was executed.
State Saved	No
Initial S/W Revision	A.14.50

Key Path	SCPI Only
Mode	All
<b>Remote Command</b>	:CALibration:TEMPerature:LIF?

<b>Example</b>	:CAL:TEMP:LIF?
Notes	Value is in degrees Centigrade at which the last successful Align IF was executed.
State Saved	No
Initial S/W Revision	A.14.50

Key Path	Visual annotation in the Show Alignment Statistics screen
Mode	All
<b>Remote Command</b>	:CALibration:TIME:SOURce:LALL?
<b>Example</b>	:CAL:TIME:SOUR:LALL?
Notes	Value is the date and time of the last successful Align Now, Source was performed on the instrument.
State Saved	No
Initial S/W Revision	A.05.00

Key Path	Visual annotation in the Show Alignment Statistics screen
Mode	All
<b>Remote Command</b>	:CALibration:TEMPerature:SOURce: LALL?
<b>Example</b>	:CAL:TEMP:SOUR:LALL?
Notes	Value is in degrees Centigrade at which the last successful Align Now, Source was performed on the instrument.
State Saved	No
Initial S/W Revision	A.05.00

## Restore Align Defaults

Initializes the alignment user interface settings, not alignment data, to the factory default values. Align Now, All must be executed if the value of the Timebase DAC results in a change.

For front panel operation, you are prompted to confirm action before setting the alignment parameters to factory defaults:

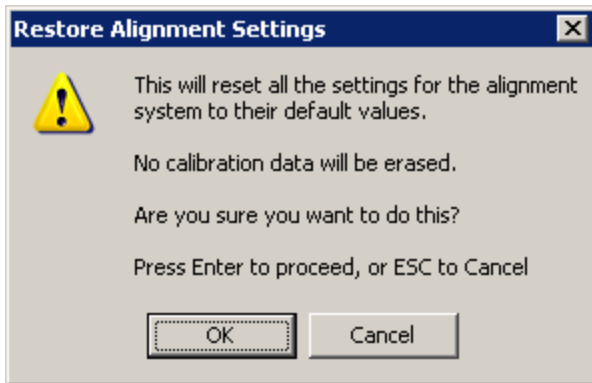

The parameters affected are:

Parameter	Setting
Timebase DAC	Calibrated
Timebase DAC setting	Calibrated value
Auto Align State	Normal (if the instrument is not operating with default alignment data, Off otherwise)
Auto Align All but RF	Off
Auto Align Alert	Time & Temperature

Key Path	System, Alignments
Mode	All
<b>Example</b>	:SYST:DEF ALIG
Notes	Alignment processing that results as the transition to Auto Alignment Normal will be executed sequentially; thus *OPC? or *WAI will wait until the alignment processing is complete.
Initial S/W Revision	Prior to A.02.00

### Execute Expired Alignments (Remote Command Only)

Alignments can be expired in the situation where Auto Align is in the state of Partial or Off. This feature runs the alignments that have expired. This is different than performing an Align All, Now operation. Align All, Now performs an alignment of all subsystems regardless of whether they are needed or not, with Execute Expired Alignments, only the individual subsystems that have become due are aligned.

Mode	All
<b>Remote Command</b>	:CALibration:EXPIred?
<b>Example</b>	:CAL:EXP?
Notes	:CALibration:EXPIred? returns 0 if successful :CALibration:EXPIred? returns 1 if failed
Initial S/W Revision	Prior to A.02.00

## I/O Config

Activates a menu for identifying and changing the I/O configuration for remote control.

Key Path	System
Initial S/W Revision	Prior to A.02.00

## SCPI LAN

Activates a menu for identifying and changing the SCPI over a LAN configuration. There are a number of different ways to send SCPI remote commands to the instrument over LAN. It can be a problem to have multiple users simultaneously accessing the instrument over the LAN. These keys limit that somewhat by disabling the telnet, socket, and/or SICL capability.

**NOTE**

By default settings: Telnet port 5023, socket port 5025, SICL server 0 and HiSLIP server 0 will be assigned to first instance; Telnet port 5123, socket port 5125, SICL server 1 and HiSLIP server 1 will be assigned to second instance; Telnet port 5223, socket port 5225, SICL server 2 and HiSLIP server 2 will be assigned to third instance; Telnet port 5323, socket port 5325, SICL server 3 and HiSLIP server 3 will be assigned to the fourth instance.

The Telnet port, socket port, physics port and HiSLIP server can also be set on the LaunchModularSA tool Setting panel.

Key Path	System, I/O Config
Initial S/W Revision	Prior to A.02.00

## SCPI Telnet

Turns the SCPI LAN telnet capability On or Off allowing you to limit SCPI access over LAN through telnet.

Key Path	System, I/O Config, SCPI LAN
Mode	All
Remote Command	:SYSTem:COMMunicate:LAN:SCPI:TELNet:ENABle OFF ON 0 1 :SYSTem:COMMunicate:LAN:SCPI:TELNet:ENABle?
Example	:SYST:COMM:LAN:SCPI:TELN:ENAB OFF
Preset	This is unaffected by Preset but is set to ON with a "Restore System Defaults->Misc"
State Saved	No
Range	On   Off
Initial S/W Revision	Prior to A.02.00



## SCPI Socket

Turns the capability of establishing Socket LAN sessions On or Off. This allows you to limit SCPI access over LAN through socket sessions.

Key Path	System, I/O Config, SCPI LAN
Mode	All
<b>Remote Command</b>	:SYSTem:COMMunicate:LAN:SCPI:SOCKet:ENABle OFF ON 0 1 :SYSTem:COMMunicate:LAN:SCPI:SOCKet:ENABle?
<b>Example</b>	:SYST:COMM:LAN:SCPI:SOCK:ENAB OFF
Preset	This is unaffected by a Preset but is set to ON with a “Restore System Defaults->Misc”
State Saved	No
Range	On   Off
Initial S/W Revision	Prior to A.02.00

## SICL Server

Turns the SICL server capability On or Off, enabling you to limit SCPI access over LAN through the SICL server. (SICL IEEE 488.2 protocol.)

Parameter	Description	Setting
Maximum Connections	The maximum number of connections that can be accessed simultaneously	5
Instrument Name	The name (same as the remote SICL address) of your analyzer	inst0
Instrument Logical Unit	The unique integer assigned to your analyzer when using SICL LAN	8
Emulated GPIB Name	The name (same as the remote SICL address) of the device used when communicating with your analyzer	gpib7
Emulated GPIB Logical Unit	The unique integer assigned to your device when it is being controlled using SICL LAN	8
Emulated GPIB Address	The emulated GPIB address assigned to your transmitter tester when it is a SICL server (the same as your GPIB address)	18

Key Path	System, I/O Config, SCPI LAN
Mode	All
<b>Remote Command</b>	:SYSTem:COMMunicate:LAN:SCPI:SICL:ENABle OFF ON 0 1 :SYSTem:COMMunicate:LAN:SCPI:SICL:ENABle?
<b>Example</b>	:SYST:COMM:LAN:SCPI:SICL:ENAB OFF
Preset	This is unaffected by Preset, but is set to ON with a “Restore System Defaults->Misc”
State Saved	No
Range	On   Off

Initial S/W Revision	Prior to A.02.00
----------------------	------------------

### HiSLIP Server

Turns the HiSLIP server capability On or Off, enabling you to limit SCPI access over LAN through the HiSLIP server.

HiSLIP stands for High Speed LAN Instrument Protocol and is part of the IVI-6.1 specification.

Here is an example of a VISA connection string used to connect to the HiSLIP Server on an X-Series Spectrum Analyzer:

```
TCPIP0::a-n9030a-93016::hislip0::INSTR
```

In the example above, hislip0 is the HiSLIP device name that VISA users must include in their HiSLIP VISA Address strings. Your HiSLIP device name may be different depending on your VISA settings.

<b>Key Path</b>	System, I/O Config, SCPI LAN
<b>Mode</b>	All
<b>Remote Command</b>	:SYSTem:COMMunicate:LAN:SCPI:HISLip:ENABle OFF ON 0 1 :SYSTem:COMMunicate:LAN:SCPI:HISLip:ENABle?
<b>Example</b>	:SYST:COMM:LAN:SCPI:HISL:ENAB OFF
<b>Preset</b>	This is unaffected by Preset, but is set to ON with a “Restore System Defaults->Misc”
<b>State Saved</b>	No
<b>Range</b>	On   Off
<b>Initial S/W Revision</b>	A.11.00

### SCPI Socket Control Port (Remote Command Only)

Returns the TCP/IP port number of the control socket associated with the SCPI socket session. This query enables you to obtain the unique port number to open when a device clear is to be sent to the instrument. Every time a connection is made to the SCPI socket, the instrument creates a peer control socket. The port number for this socket is random. The user must use this command to obtain the port number of the control socket. To force a device clear on this socket, open the port and send the string “DCL ” to the instrument.

If this SCPI command is sent to a non SCPI Socket interface, then 0 is returned.

<b>Mode</b>	All
<b>Remote Command</b>	:SYSTem:COMMunicate:LAN:SCPI:SOCKet:CONTrol?
<b>Example</b>	:SYST:COMM:LAN:SCPI:SOCK:CONT?
<b>Preset</b>	This is unaffected by Preset or “Restore System Defaults->Misc”.
<b>State Saved</b>	No
<b>Range</b>	0 to 65534

Min	0
Max	65534
Initial S/W Revision	Prior to A.02.00

## System IDN Response

This key allows you to specify a response to the \*IDN? query, or to return the analyzer to the Factory response if you have changed it.

To choose the factory-set response, press the Factory key.

To specify your own response, press the User key, and enter your desired response.

If your test software is expecting the response to indicate Agilent Technologies as the Manufacturer, you can conveniently configure the response by pressing the Agilent key.

Key Path	System, I/O Config
Mode	All
<b>Remote Command</b>	
Notes	<ul style="list-style-type: none"> <li>• This affects the response given in all Modes of the Analyzer, unless the current Mode has also specified a custom response, in which case the current Mode's custom IDN response takes precedence over the System's, but only while that Mode is the current Mode..</li> <li>• It survives shutdown and restart of the software and therefore survives a power cycle</li> </ul>
Preset	This is unaffected by Preset but is set to Factory on a "Restore System Defaults->Misc"
State Saved	No
Initial S/W Revision	A.06.00
Modified at S/W Revision	x.14.50

## Factory

This key selects the factory setting, for example:

"Keysight Technologies,M9420A,MY00012345, E.14.50"

where the fields are manufacturer, model number, serial number, firmware revision.

Note: In products that run multiple instances of the X-Series Application, all instances use the same factory System IDN response.

Key Path	System, I/O Config, IDN Response
<b>Example</b>	:SYST:IDN:CONF FACT
Initial S/W Revision	A.06.0

## User

This key allows you to specify your own response to the \*IDN? query. You may enter your desired response with the Alpha Editor or a plugin PC keyboard.

When you press this key, the active function becomes the current User string with the cursor at the end. This makes it easy to edit the existing string.

If you enter a null string (for example, by clearing the User String while editing and then pressing Done) the analyzer automatically reverts to the Factory setting.

Note: In products that run multiple instances of the X-Series Application, all instances use the same User System IDN response.

Key Path	System, I/O Config, IDN Response
Example	:SYST:IDN:CONF USER
Initial S/W Revision	A.06.00

## SYSTem:IDN Response setting (Remote command)

This SCPI command is used to set or clear the User SYSTem:IDN response.

<b>Remote Command</b>	:SYSTem:IDN <string> :SYSTem:IDN?
Notes	<ul style="list-style-type: none"> <li>• The format of the &lt;string&gt; must be four fields each separated by a comma, example: :SYST:IDN "XYZ Corp,Model 12,012345,A.01.01"</li> <li>• The four fields are &lt;manufacturer&gt;, &lt;model number&gt;, &lt;serial number&gt;, &lt;firmware revision&gt;. Thus, the text within a field cannot contain a comma.</li> <li>• This affects the response given in all Modes of the Analyzer, unless the current Mode has also specified a custom response, in which case the current Mode's custom IDN response takes precedence over the System's, but only while that Mode is the current Mode..</li> <li>• It survives shutdown and restart of the software and therefore survives a power cycle</li> <li>• Null string as parameter restores the Factory setting, example: :SYST:IDN ""</li> </ul>
Preset	This is unaffected by Preset but is set to the original factory setting on a "Restore System Defaults->Misc"
Initial S/W Revision	A.06.00

## Lock Remote I/O Session (Remote Command only)

You can lock the SCPI control of the instrument to the I/O Interface and Session by performing a SYSTem:LOCK:REQuest? Query. This permits cooperative sharing of the instrument between multiple computers, or multiple sessions from the same computer.

**NOTE**

Use of cooperative sharing (locking) must take into account the properties of an interface, interfaces are either single session or multiple session:

NOTE	I n t e r f a c e	NOTE	Sin gle Ses sion	NOTE	Multi ple Sessi on
NOTE	G P I B	NOTE	✓	NOTE	
NOTE	U S B - 4 8 8	NOTE	✓	NOTE	
NOTE	L A N V X I - 1 1 ( S I C L )	NOTE	✓	NOTE	
NOTE	L A N S o c k e t	NOTE		NOTE	✓

NOTE	L A N H i S L I P	NOTE	NOTE	✓
NOTE	L A N T e l n e t	NOTE	NOTE	✓

**NOTE** It is inappropriate to control the instrument from multiple computers (or multiple processes or threads of a single computer) when using single session interfaces. In particular, care must be taken when using LAN VXI-11 (SICL) interface that only a single computer (or single process or single thread) is controlling the instrument; if multiple computers are controlling the instrument responses may not result in expected operation.

It is not recommend to use VXI-11 with SCPI locking as multiple clients can simultaneously connect to the instrument. If VXI-11 is required then VISA locking must be used in addition to SCPI locking.

The recommended interface is LAN HiSLIP. Since HiSLIP is a multiple session interface, the controlling computer can send lock requests from multiple applications (or multiple threads of a single application) to permit cooperative sharing of the instrument.

<b>Remote Command</b>	SYSTem:LOCK:REQuest?
<b>Example</b>	SYST:LOCK:REQ?
<b>Notes</b>	<p>The command returns a 1 if the lock request is granted, 0 is returned if the request is denied.</p> <p>Single Session interfaces will always return 1 once the same interface has already received a lock request.</p> <p>Lock requests on an individual interface and session can be nested and each request will increase an internal lock count by 1. For every granted request, you will need to perform a SYSTem:LOCK:RELease to decrement the internal lock count to fully relinquish the lock.</p> <p>When the instrument is locked bit 0 is set in the Operation Instrument status register.</p> <p>Disconnecting the individual interface and session will release the lock if the lock is granted to the interface and session.</p> <p>A Device Clear over any interface and session will release the lock, regardless of the interface and session which obtained the lock.</p>

---

The following queries are permitted over any interface and session even if an interface has the instrument locked:

\*IDN?

\*OPT?

\*STB?

\*ESR?

:SYSTem:DATE?

:SYSTem:TIME?

:SYSTem:PON:TIME?

Queries in the :STATus subsystem

Queries in the :SYSTem:ERRor subsystem

Queries in the :SYSTem:LKEY subsystem

Queries in the :SYSTem:LOCK subsystem

Queries in the :SYSTem:METRics subsystem

Queries in the :SYSTem:MODule subsystem

All other commands and queries will result in the error: -203, "Command protected; Instrument locked by another I/O session"

---

State Saved	Not part of Save/Recall
-------------	-------------------------

---

Initial S/W Revision	x.16.10
----------------------	---------

---

## Unlock Remote I/O Session (Remote Command only)

You can unlock the SCPI control of an I/O Interface and Session performing a SYSTem:LOCK:RELease command. Lock requests on an individual interface and session can be nested and each request will increase an internal lock count by 1. For every granted request, you will need to perform a release. The lock is not relinquished until the internal lock count is at 0.

---

<b>Remote Command</b>	SYSTem:LOCK:RELease
-----------------------	---------------------

---

<b>Example</b>	SYST:LOCK:REL
----------------	---------------

---

Notes	When the instrument is unlocked bit 0 is cleared in the Operation Instrument status register.
-------	-----------------------------------------------------------------------------------------------

---

Initial S/W Revision	x.16.10
----------------------	---------

---

## Remote I/O Session Lock Name (Remote Command only)

You can determine the I/O Interface and Session name of the currently running program with the query SYSTem:LOCK:NAME?.

---

<b>Remote Command</b>	SYSTem:LOCK:NAME?
-----------------------	-------------------

---

<b>Example</b>	SYST:LOCK:NAME?
----------------	-----------------

---

Notes	The information returned is a string of the format:
-------	-----------------------------------------------------

"<I/O Interface>[/<IP address>/<Session ID>]"

Where IP address and Session ID are only provided for interfaces that provide multiple sessions.

---

---

	Single Session interfaces (GPIB, USB-488, and LAN VXI-11) only list interface name. The Session ID is an internally generated identifier, it is not guaranteed to be consistent across instrument software versions (the identifier is free to change when the software of the instrument is updated). The absolute value of the Session ID is not significant, the identifier will be consistent for a given software version and can be relied upon for lock owner logic comparisons.
Initial S/W Revision	x.16.10

---

### Remote I/O Session Lock Owner (Remote Command only)

You can determine which I/O Interface and Session has the SCPI locked with the query `SYSTem:LOCK:OWNer?`. If no interface and session has the SCPI locked "NONE" is returned.

---

<b>Remote Command</b>	<code>SYSTem:LOCK:OWNer?</code>
<b>Example</b>	<code>SYST:LOCK:OWN?</code>
<b>Notes</b>	The information returned is a string of the format: “<I/O Interface>[/<IP address>/<Session ID>]” Where IP address and Session ID are only provided for interfaces that provide multiple sessions. Single Session interfaces (GPIB, USB-488, and LAN VXI-11) only list interface name. The Session ID is an internally generated identifier, it is not guaranteed to be consistent across instrument software versions (the identifier is free to change when the software of the instrument is updated). The absolute value of the Session ID is not significant, the identifier will be consistent for a given software version and can be relied upon for lock owner logic comparisons. If no interface and session have the SCPI locked the return value is "NONE".
Initial S/W Revision	x.16.10

---

### Restore Defaults

Provides incremental initialization of the system setting groups along with supporting a comprehensive reset of the entire instrument back to a factory default state. The menu selections are the groups of system settings and when one is selected, that particular group of system settings is reset back to their default values.

**NOTE**

In products that run multiple instances of the X-Series Application, all instances have the same factory default states for Restore Defaults.

---

<b>Key Path</b>	System
<b>Mode</b>	All
<b>Remote Command</b>	<code>:SYSTem:DEFault [ALL]   ALIGn   INPut   MISC   MODes   PON</code>
<b>Example</b>	<code>SYST:DEF</code>
<b>State Saved</b>	No
Initial S/W Revision	Prior to A.02.00

---



## Restore Input/Output Defaults

Causes the group of settings and data associated with Input/Output front-panel key to be a reset to their default values. This level of Restore System Defaults does not affect any other system settings, mode settings and does not cause a mode switch. .

Confirmation is required to restore the Input/Output setting. The confirmation dialog is:

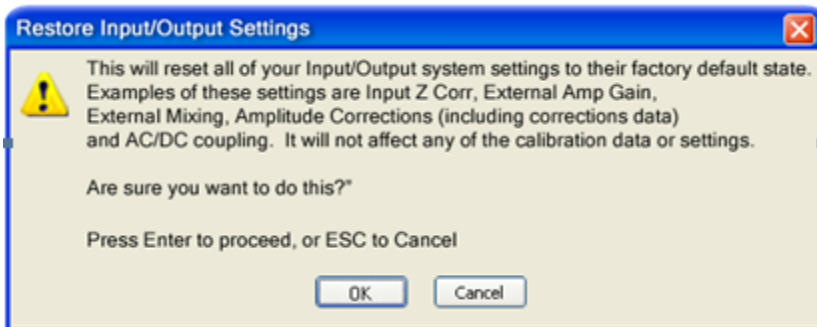

---

Key Path                      System, Restore System Defaults

---

**Example**                      :SYST:DEF INP

---

Initial S/W Revision        Prior to A.02.00

---

## Restore Power On Defaults

This selection causes the Power On settings to be a reset to their default value. This level of Restore System Defaults does not affect any other system settings, mode settings and does not cause a mode switch. The Power On settings and their default values are Power On Type reset to Mode and Input/Output Defaults and Power On Application reset to whatever the factory set as its default value.

Confirmation is required to restore the factory default values. The confirmation dialog is:

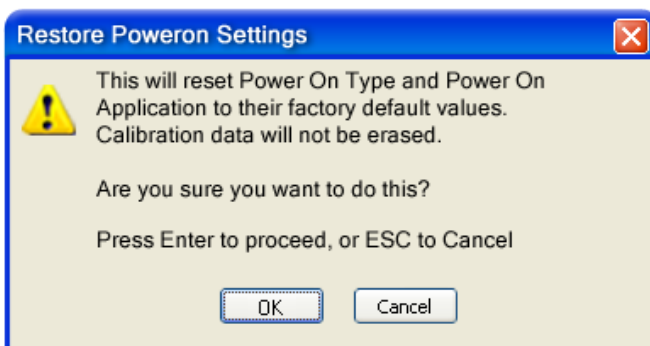

---

Key Path                      System, Restore System Defaults

---

**Example**                      :SYST:DEF PON

---

Initial S/W Revision        Prior to A.02.00

---

## Restore Align Defaults

This selection causes the Alignment system settings to be a reset to their default values. This does not affect any Alignment data stored in the system. This level of Restore System Defaults does not affect any other system settings, mode settings and does not cause a mode switch.

After performing this function, it may impact the auto-alignment time of the instrument until a new alignment baseline has been established.

Confirmation is required to restore the factory default values. The confirmation dialog is:

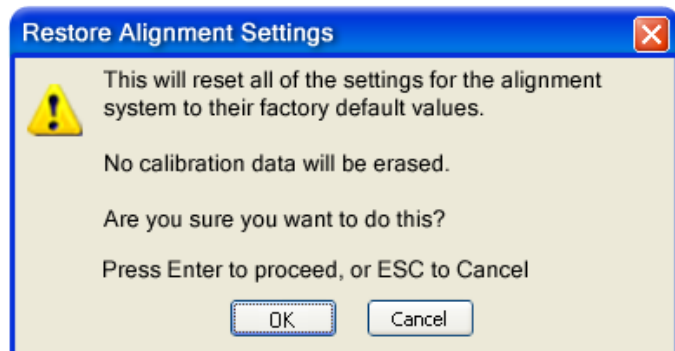

---

Key Path                      System, Restore System Defaults

---

**Example**                      :SYST:DEF ALIG

---

Initial S/W Revision        Prior to A.02.00

---

## Restore Misc Defaults

This selection causes miscellaneous system settings to be reset to their default values. With this reset, you lose the GPIB address and it is reset to 18, so this should be used with caution. This level of Restore System Defaults does not affect any other system settings, mode settings and does not cause a mode switch. This miscellaneous group contains the rest of the settings that have not been part of the other Restore System Defaults groups. The following table is a complete list of settings associated with this group:

Miscellaneous Setting	Default Value
Verbose SCPI	Off
The SYST:PRES:TYPE	MODE
Auto File Name Number	000
Save Type	State
State Save To	Register 1
Screen Save To	SCREEN000.png
DISP:ENABLe	ON
Full Screen	Off

Miscellaneous Setting	Default Value
SCPI Telnet	ON
SCPI Socket	ON
SICL Server	ON
Softkey Language	English
System Annotation	ON
Display Theme	TDColor
System IDN Response	Factory result of *IDN?
System IDN Response selection	Factory

Confirmation is required to restore the factory default values. The confirmation dialog is:

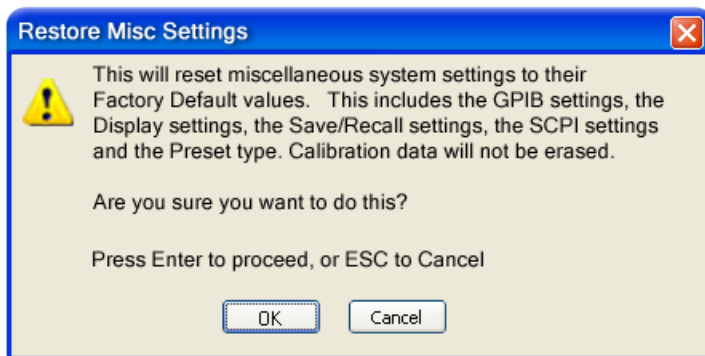

Key Path	System, Restore System Defaults
<b>Example</b>	:SYST:DEF MISC
Initial S/W Revision	Prior to A.02.00
Modified at S/W Revision	x.14.50

### Restore Mode Defaults (All Modes)

This selection resets all of the modes in the instrument back to their default state just as a Restore Mode Defaults does and it switches the instrument to the power-on mode and causes the default measurement for the power-on mode to be active. This level of Restore System Defaults does not affect any system settings, but it does affect the state of all modes and does cause a mode switch unless the instrument was already in the power-on mode.

Confirmation is required to restore the factory default values. The confirmation dialog is:

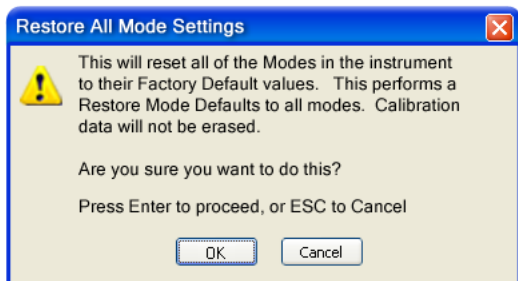

Key Path	System, Restore System Defaults
Example	:SYST:DEF MOD
Couplings	An All Mode will cause the currently running measurement to be aborted, mode switch to the power-on mode and activate the default measurement for the power-on mode.. It gets the mode to a consistent state with all of the default couplings set.
Initial S/W Revision	Prior to A.02.00

## All

This performs a comprehensive reset of ALL analyzer settings to their factory default values. It resets all of the system setting groups, causes a Restore Mode Defaults for all modes in the instrument, and switches back to the power-on mode. It does not affect the User Preset file or any user saved files.

Confirmation is required to restore the factory default values. The confirmation dialog is:

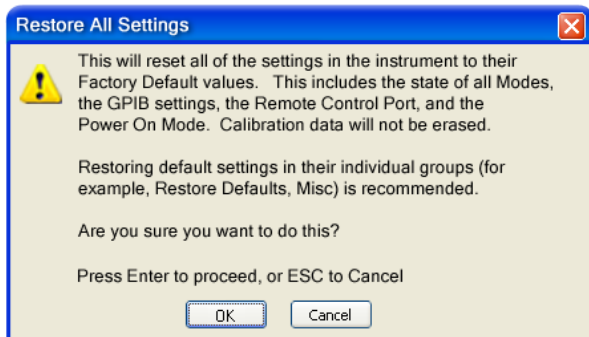

### NOTE

If you are using an Keysight USB External Mixer, then you will need to perform a Refresh USB Mixer Connection after Restoring All Defaults.

Key Path	System, Restore System Defaults
Example	:SYST:DEF ALL
Notes	If using Keysight USB External Mixer, perform a Refresh USB Mixer Connection (SCPI command :MIX:BAND USB) following a Restore All Defaults.
Couplings	An All will cause the currently running measurement to be aborted and get all modes to a consistent state, so it is unnecessary to couple any settings.
Initial S/W Revision	Prior to A.02.00
Modified at S/W Revision	A.14.00

## Control Panel...

Opens the Windows Control Panel. The Control Panel is used to configure certain elements of Windows that are not configured through the hardkey/softkey System menus.

**NOTE** This feature is not available if option SF1 is installed.

The Control Panel is a separate Windows application, so to return to the analyzer once you are in the Control Panel, you may either:

Exit the Control Panel by clicking on the red X in the upper right hand corner, with a mouse

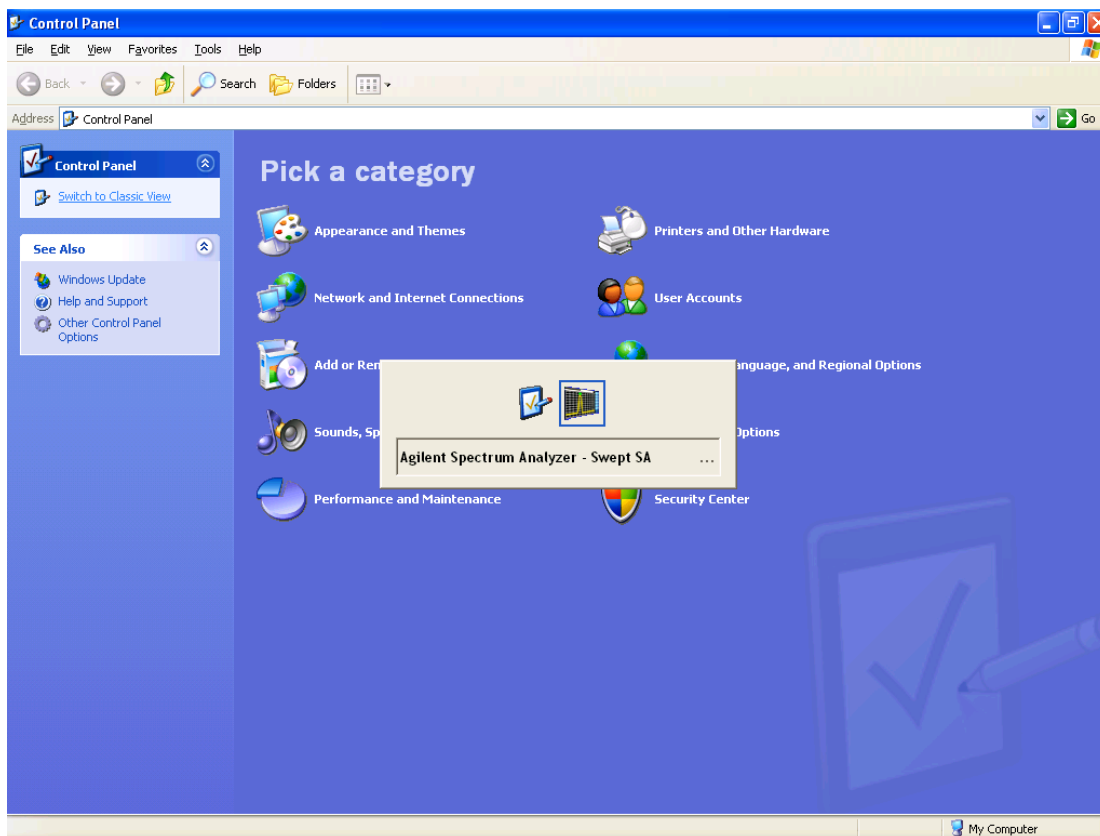

Or use Alt-Tab: press and hold the Alt key and press and release the Tab key until the Analyzer logo is showing in the window in the center of the screen, as above, then release the Alt key.

Key Path	System
Notes	No remote command for this key.
Initial S/W Revision	Prior to A.02.00

## Licensing...

Opens the license explorer.

**NOTE** This feature is not available if option SF1 is installed.

For Help on this key, select Help in the menu bar at the top of the license explorer window.

Key Path	System
Notes	No equivalent remote command for this key.
Backwards Compatibility Notes	In ESA the SCPI command for displaying the Show Licenses screen is: :SYSTem:CONFigure:LKEY:STATe OFF ON 0 1:SYSTem:CONFigure:LKEY:STATe? There are no equivalent SCPI commands in the X-Series for displaying the License Explorer.
Initial S/W Revision	Prior to A.02.00

**Remote Command** :SYSTem:LKEY <"OptionInfo">, <"LicenseInfo">

**Example** SYST:LKEY "N9073A-1FP",  
"027253AD27F83CDA5673A9BA5F427FDA5E4F25AEB1017638211AC9F60D9C639FE539735909C551DE0A91"

**Notes** The <"OptionInfo"> contains the feature and the version. You must specify the feature but can omit the version. If you omit the version, the system regards it as the latest one, since the system knows which version is supported for each feature.  
The <"LicenseInfo"> contains the signature, the expiration date, and serial number for transport if transportable. You must specify the signature, but you can omit the other information. If you omit the expiration date, the system regards it as permanent. If you omit the serial number, the system regards it as non-transportable. As a result, this supports reverse compatibility.

Initial S/W Revision Prior to A.02.00

**Remote Command** :SYSTem:LKEY:DELeTe <"OptionInfo">,<"LicenseInfo">

**Example** SYST:LKEY:DEL 'N9073A-1FP',  
"027253AD27F83CDA5673A9BA5F427FDA5E4F25AEB1017638211AC9F60D9C639FE539735909C551DE0A91"

**Notes** The <"OptionInfo"> contains the feature and the version. You must specify the feature but can omit the version. If you omit the version, the system regards it as the latest one, if more than one version is installed.  
The <"LicenseInfo"> contains the signature, the expiration date, and whether or not be transportable. You must specify the signature, but you can omit the other information. If you omit the expiration date, the system regards it as permanent. If you omit the transportability, the system regards it as non-transportable. As a result, this supports reverse compatibility.

Initial S/W Revision Prior to A.02.00

<b>Remote Command</b>	:SYSTem:LKEY:LIST?
Notes	<p>Return Value: An &lt;arbitrary block data&gt; of all the installed instrument licenses. The format of each license is as follows. &lt;Feature&gt;,&lt;Version&gt;,&lt;Signature&gt;,&lt;Expiration Date&gt;,&lt;Serial Number for Transport&gt; Return Value Example: #3136 N9073A-1FP,1.000,B043920A51CA N9060A-2FP,1.000,4D1D1164BE64 N9020A-508,1.000,389BC042F920 N9073A-1F1,1.000,5D71E9BA814C,13-aug-2005 &lt;arbitrary block data&gt; is: #NMMM&lt;data&gt; Where: N is the number of digits that describes the number of MMM characters. For example if the data was 55 bytes, N would be 2. MMM would be the ASCII representation of the number of bytes. In the previous example, N would be 55. &lt;data&gt; ASCII contents of the data</p>
Initial S/W Revision	Prior to A.02.00
<b>Remote Command</b>	:SYSTem:LKEY? <"OptionInfo">
<b>Example</b>	SYST:LKEY? "N9073A-1FP"
Notes	<p>The &lt;"OptionInfo"&gt; contains the feature and the version. You must specify the feature but can omit the version. If you omit the version, the system regards it as the latest one. Return Value: &lt;"LicenseInfo"&gt; if the license is valid, null otherwise. &lt;"LicenseInfo"&gt; contains the signature, the expiration date, and serial number if transportable. Return Value Example: "B043920A51CA"</p>
Initial S/W Revision	Prior to A.02.00
<b>Remote Command</b>	:SYSTem:HID?
Notes	Return value is the host ID as a string
Initial S/W Revision	Prior to A.02.00

## Security

Accesses capabilities for operating the instrument in a security controlled environment.

Key Path	System
Initial S/W Revision	A.04.00

## USB

The Windows operating system can be configured to disable write access to the USB ports for users who are in a secure environment where transferring data from the instrument is prohibited. This user interface is a convenient way for the customer to disable write access to USB.

Key Path	System, Security
Mode	All
Scope	Mode Global
<b>Remote Command</b>	:SYSTem:SECurity:USB:WPRotect[:ENABLE] ON OFF 0 1 :SYSTem:SECurity:USB:WPRotect[:ENABLE]?
<b>Example</b>	:SYST:SEC:USB:WPR ON Will set USB ports to Read-only
Notes	When the USB ports are in Read-only mode then no data can be stored to USB, including the internal USB memory used for a back-up location for the calibration data.
Dependencies	This key is grayed-out unless the current user has administrator privileges.
Preset	This is unaffected by Preset or any Restore System Defaults. An Agilent Recovery will set the USB to write protect OFF
State Saved	No
Range	Read-Write Read only
Initial S/W Revision	A.04.00

## Read-Write

Selection for allowing full read-write access to the USB ports.

Key Path	System, Security, USB
<b>Example</b>	:SYST:SEC:USB:WPR OFF Will set USB ports to Read-Write
Initial S/W Revision	A.04.00

## Read only

Selection for disabling write access to the USB ports.



Key Path	System, Security, USB	
Example	:SYST:SEC:USB:WPR ON	Will set USB ports to Read only
Initial S/W Revision	A.04.00	

## Diagnostics

The Diagnostics key in the System menu gives you access to basic diagnostic capabilities of the instrument.

Key Path	System	
Initial S/W Revision	Prior to A.02.00	

## Show Hardware Statistics

Provides a display of various hardware statistics. The statistics include the following:

- High and Low temperature extremes
- Elapsed time that the instrument has been powered-on (odometer)

The display should appear listing the statistics, product number, serial number, and firmware revision.

Hardware Statistical Information		
Agilent MXA Signal Analyzer Product Number: N9020A Serial Number: US00061145 Instrument S/W Revision: A.12.00 Revision Date: 7/11/2012 12:11:10 PM		
Component Name	Value	
MechAtten #1 Count Total	457304	
Calibrator Switch Cycles	105953	In some CXA models this field is called "Fixed Aten"
AC/DC Switch Cycles	114240	
2 dB #1 Mechanical Atten Cycles	112655	Some CXA models omit these fields
2 dB #2 Mechanical Atten Cycles	124456	
MechAtten #2 Count Total	472265	
6 dB Mechanical Atten Cycles	115302	
10 dB Mechanical Atten Cycles	93602	
20 dB Mechanical Atten Cycles	144781	
30 dB Mechanical Atten Cycles	118580	
Low Noise Path Switch	Only shown if LNP installed 45668	
Preselector Bypass Cycles	Only shown if MPB installed 31133	
High temperature operating extreme	45.75	
Low temperature operating extreme	-23.9375	
Elapsed Time (On-Time)(hours)	134164	

The CXA models in which the AC/DC Switch field is called Fixed Atten and that omit the mechanical attenuation fields are the N9000A–503/507 models.

Modular HWs only have time and temperature information in Show Hardware Statistics.

The data will be updated only when the Show Hardware Statistics menu key is pressed, it will not be updated while the screen is displayed.

The tabular data should be directly printable.

Key Path	System, Diagnostics
Mode	All
Notes	The values displayed on the screen are only updated upon entry to the screen and not updated while the screen is being displayed.
Initial S/W Revision	Prior to A.02.00

### SCPI for Show Hardware Statistics ( Remote Commands Only)

Each of the hardware statistic items can be queried via SCPI.

- Error! Reference source not found.
- Error! Reference source not found.
- Error! Reference source not found.

### Self test

This key gives you access to diagnostic capabilities for self tests of the instrument.

Key Path	System, Diagnostics
Initial S/W Revision	Prior to A.10.00

### All Self Test

This key invokes all the self tests defined in the Diagnostics Self Test section.

Key Path	System, Diagnostics, Self Test
Remote Command	SYSTem:TEST:WCTS:[ALL]
Example	SYST:TEST:WCTS:[ALL]
Initial S/W Revision	A.12.50

### FEC Self Test

This key invokes the EXT E6607C front end control self test. When operation is complete, the generated test summary information is appended to log file E:\Agilent\Instrument\FECTestLog.txt. This test summary

file can be retrieved from the instrument using the MMEM set of SCPI command, once you have the fully qualified the path and file name.

If the self test fails, the following error message will be generated:

All other models:

“-330, Self-test failed, see log file E:\Agilent\Instrument\FECTestLog.txt”

M9420A:

“-330, Self-test failed, see Front end self test log file under C:\ProgramData\Keysight\X-Series Instrument”

If the self test passes, an advisory message “FEC self-test completed successfully” is generated.

Key Path	System, Diagnostics, Self Test
Remote Command	SYSTem:TEST:WCTS:FEC
Example	SYST:TEST:WCTS:FEC
Notes	Access log with command : All other models: MMEM:DATA? "E:\ Agilent\Instrument\FECTestLog.txt" M9420A: MMEM:DATA? " C:\ProgramData\Keysight\X-Series Instrument\_FECSelfTestLog_M9420A_<SerialNumber>.txt "
Initial S/W Revision	A.12.50

## Show Result

This key gives you access to show results of the following self tests:

- Source self-test results
- E6607C embedded MPA or E6640A/E6650A RFIO self-test results
- E6607C FEC self-test results

Key Path	System, Diagnostics, Self Test
Initial S/W Revision	A.12.50

## FEC Self Test Results

Provides a display of last FEC test results, the display should appear listing model number, serial number and test time at the top of display, and then list test date/time, test name, measured value, valid range and pass/fail of each FEC test item, the tabular data should be directly printable.

Key Path	System, Diagnostics, Self Test,Show Results
----------	---------------------------------------------

<b>Remote Command</b>	SYSTem:TEST:WCTS:SHOW:RESult FEC
<b>Example</b>	SYST:TEST:WCTS:SHOW:RES FEC
Initial S/W Revision	A.12.50

The example of FEC self test result display is as follows:

FEC Self Test Results					
Produce Number: E6607C					
Serial Number: MY51380437					
Instrument S/W: 11/16/2012 2:51:19 PM					
FpgaVersionTest					
Date	Time(GMT)	Name	MeasValue	ValidRange	Result
11/23/2012	16:13:56	Analog_FPGA	16.000	>= 16.000	Pass
11/23/2012	16:13:56	Digital_FPGA	50.000	>= 46.000	Pass
11/23/2012	16:13:56	CRFS_FPGA	38.000	>= 38.000	Pass
PowerSupplyTest					
Date	Time(GMT)	Name	MeasValue	ValidRange	Result
11/23/2012	16:13:56	ABUS_+32CHK	31.904	30.900 - 32.900	Pass
11/23/2012	16:13:56	ABUS_+12CHK	12.296	10.800 - 13.200	Pass
11/23/2012	16:13:56	+10VA	9.935	9.600 - 10.200	Pass
11/23/2012	16:13:56	+5VA	4.995	4.900 - 5.100	Pass
11/23/2012	16:13:56	+3.3VA	3.299	3.200 - 3.400	Pass
11/23/2012	16:13:56	-3.3VA	-3.311	-3.400 - -3.200	Pass
11/23/2012	16:13:56	ACOM	0.00	-0.200 - 0.200	Pass
11/23/2012	16:13:56	-5VA	-5.036	-5.100 - -4.900	Pass
11/23/2012	16:13:56	-6.1VA	-5.880	-6.200 - -5.700	Pass
11/23/2012	16:13:56	-10VA	-10.116	-10.200 - -9.800	Pass
11/23/2012	16:13:56	ABUS_-2.5V_REF	-2.508	-2.520 - -2.470	Pass
11/23/2012	16:13:56	ABUS_+2.5V_REF	2.508	2.480 - 2.520	Pass
11/23/2012	16:13:56	ABUS_-10VPALC	-10.047	-10.200 - -9.800	Pass

11/23/2012	16:13:57	ABUS_DET_MOD_FLT	18.000	7.800 - 100.000	Pass
------------	----------	------------------	--------	--------------------	------

### Show FEC Self Test Results contents (Remote Command Only)

A remote command is available to obtain the contents of the Show FEC Self Test Results screen (the entire contents, not just the currently displayed page).

<b>Remote Command</b>	SYSTem:TEST:WCTS:FEC:RESult?
<b>Example</b>	SYST:TEST:WCTS:FEC:RES?
<b>Notes</b>	The output is an IEEE Block format of the Show FEC Self Test Results contents. Each line is separated with a new-line character.
<b>Initial S/W Revision</b>	A.12.50

	Keysight Converged	PSA
IP Address	SYSTem:COMMunicate:LAN:ADDRes <string> SYSTem:COMMunicate:LAN:ADDRes?	:SYSTem:COMMunicate:LAN[SELF]:IP <string> :SYSTem:COMMunicate:LAN[SELF]:IP?
Gateway	SYSTem:COMMunicate:LAN:DGATeway <string> SYSTem:COMMunicate:LAN:DGATeway?	:SYSTem:COMMunicate:LAN[SELF]:GATEway <string> :SYSTem:COMMunicate:LAN[SELF]:GATEway?
Subnet Mask	SYSTem:COMMunicate:LAN:SMASk <string> SYSTem:COMMunicate:LAN:SMASk?	:SYSTem:COMMunicate:LAN[SELF]:SUBNetmask <string> :SYSTem:COMMunicate:LAN[SELF]:SUBNetmask?

### Internet Explorer...

This key launches Microsoft Internet Explorer. A mouse and external keyboard are highly desired for using Internet Explorer. When Internet Explorer is running, close Internet Explorer to return focus to the Instrument Application (or use Alt-Tab).

<b>Key Path</b>	System
<b>Mode</b>	All
<b>Notes</b>	No equivalent remote command for this key.
<b>Initial S/W Revision</b>	A.05.01



## 7 Trigger Functions

## Trigger

Accesses a menu of keys to control the selection of the trigger source and the setup of each of the trigger sources. The analyzer is designed to allow triggering from a number of different sources, for example, Free Run, Video, External, RF Burst, and so forth.

The TRIG:SOURCe command (below) will specify the trigger source for the currently selected input (RF or I/Q). If you change inputs, the new input remembers the trigger source it was last programmed to for the current measurement, and uses that trigger source. You can directly set the trigger source for each input using the TRIGger:RF:SOURce and TRIGger:IQ:SOURce commands (later in this section). When in External Mixing, the analyzer uses the RF trigger source.

Note the inclusion of the <measurement> parameter in the command below. Because each measurement remembers its own Trigger Source, the command must be qualified with the measurement name. Note that for the Swept SA measurement this is not the case; for backwards compatibility, no <measurement> parameter is used when setting the Trigger Source for the Swept SA measurement.

See ["Trigger Source Presets" on page 245](#)

See ["RF Trigger Source" on page 248](#)

See ["I/Q Trigger Source" on page 249](#)

See ["More Information" on page 250](#)

Key Path	Front-panel key
<b>Remote Command</b>	<pre>:TRIGger:&lt;measurement&gt;[:SEquence]:SOURce EXTernal1   EXTernal2   IMMediate   LINE   FRAMe   RFBurst   VIDeo   IF   ALARm   LAN   IQMag   IDEMod   QDEMod   IINPut   QINPut   AIQMag   TV   INTernal  :TRIGger:&lt;measurement&gt;[:SEquence]:SOURce?</pre> <p>where &lt;measurement&gt; is the measurement for which you wish to set the Source (blank for the Swept SA measurement)</p>
<b>Example</b>	<pre>TRIG:ACP:SOUR EXT1</pre> <p>Selects the external 1 trigger input for the ACP measurement and the selected input</p> <pre>TRIG:SOUR VID</pre> <p>Selects video triggering for the Swept SA (SANalyzer) measurement in the Spectrum Analyzer mode. For SAN, do not use the &lt;measurement&gt; keyword. Only send this form in the Spectrum Analyzer mode or you will get an Undefined Header error</p>
<b>Notes</b>	<p>Not all measurements have all the trigger sources available to them. Check the trigger source documentation for your specific measurement to see what sources are available.</p> <p>Not all trigger sources are available for each input. See the <a href="#">"RF Trigger Source" on page 248</a> and <a href="#">"I/Q Trigger Source" on page 249</a> commands for detailed information on which trigger sources are available for each input.</p> <p>Other trigger-related commands are found in the INITiate and ABORt SCPI command subsystems.</p> <p>*OPC should be used after requesting data. This will hold off any subsequent changes to the selected trigger source, until after the sweep is completed and the data is returned.</p> <p>Available ranges and presets can vary from mode to mode.</p>
<b>Dependencies</b>	<p>In some models, there is no second External input. In these models, the External 2 key is blanked and</p>



	the EXTERNAL2 parameter will generate a "Hardware missing; Not available for this model number" message. INTERNAL is only available for M9420A.
Preset	See table below
Status Bits/OPC dependencies	The Status Operation Register bit 5 "Waiting for Trigger" is set at the same time as the Sweeping or Measuring bit is set. It is cleared when the trigger actually occurs (that is, after the trigger event occurs and all the applicable trigger criteria have been met). A corresponding pop-up message ("Waiting for trigger") is generated if no trigger signal appears after approximately 2 sec. This message goes away when a trigger signal appears.
<b>Backwards Compatibility SCPI</b>	:TRIGger[:SEquence]:SOURce EXTERNAL For backward compatibility, the parameter EXTERNAL is mapped to EXTERNAL1
<b>Backwards Compatibility SCPI</b>	[:SENSe]:<measurement>:TRIGger:SOURce This backwards compatibility alias command is provided for ESA/PSA compatibility This backwards compatibility command does not apply to the Swept SA measurement, for that just use :TRIGger:SOURce This backwards compatibility command does not apply to the monitor spectrum, log plot and spot frequency measurements
<b>Backwards Compatibility SCPI</b>	[:SENSe]:<measurement>:TRIGger:SOURce IF In earlier instruments, the parameter IF was used by apps for the video trigger, so using the IF parameter selects VIDEO triggering. Sending IF in the command causes VID to be returned to a query.
<b>Backwards Compatibility SCPI</b>	[:SENSe]:ACPr:TRIGger:SOURce This backwards Compatibility SCPI command is provided to support the same functionality as [:SENSe]:ACPr:TRIGger:SOURce (PSA W-CDMA, PSA cdma2000 and PSA 1xEVDO) due to the fact that the ACPr node conflicts with the ACPower node.
Initial S/W Revision	Prior to A.02.00
Modified at S/W Revision	A.03.00

## Trigger Source Presets

Here are the Trigger Source Presets for the various measurements:

Meas	Mode	Preset for RF	Preset for IQ	Notes
Swept SA	SA	IMM	IQ not supported	
CHP	SA, WCDMA, C2K, WIMAX OFDMA, 1xEVDO, DVB-T/H, DTMB, LTE, LTETDD, CMMB, ISDB-T, Digital Cable TV, MSR	IMM	IQ not supported	

OBW	SA, WCDMA, C2K, WIMAX OFDMA, TD-SCDMA, 1xEVDO, LTE, LTETDD, CMMB, ISDB-T, MSR	1xEVDO: EXT1 others: IMM	IQ not supported	For 1xEVDO mode, the trigger source is coupled with the gate state, as well as the gate source. When the trigger source changes to RFBurst, External1 or External2, the gate state is set to on, and the gate source is set identically with the trigger source. When the trigger source changes to IMMEDIATE, VIDEO, LINE, FRAME or IF, the gate state is set to off.
CCDF	SA, WCDMA, C2K, WIMAXOFDMA, TD-SCDMA, 1xEV-DO, DVB-T/H, DTMB, LTE, LTETDD, CMMB, ISDB-T, Digital Cable TV, MSR	WIMAXOFDMA: RFBurst LTETDD: BTS: External 1 MS: Periodic Timer TD-SCDMA and 1xEV-DO: BTS: External 1 MS: RFBurst SA, WCDMA, C2K, LTE, CMMB, ISDB-T, DVB-T/H, DTMB, Digital Cable TV, MSR: IMMEDIATE	TD-SCDMA and 1xEV-DO: BTS: External 1 MS: IQMag LTETDD: BTS: External 1 MS: Periodic Timer Others: IMM	For TD-SCDMA: Trigger source is coupled with radio device. When radio device changes to BTS, trigger source will be changed to EXTERNAL1. When radio device changes to MS, trigger source will be set as RFBurst for RF or IQ Mag for BBIQ. When TriggerSource is RFBurst or IQ Mag, Measure Interval is grayed out.
ACP	SA, WCDMA, C2K, WIMAX OFDMA, TD-SCDMA, 1xEVDO, DVB-T/H, DTMB, LTE, LTETDD, CMMB, ISDB-T, Digital Cable TV, MSR	IMM	IQ not supported	
Tx Power	SA, GSM, TD-SCDMA	SA, GSM: RFBurst TD-SCDMA: EXTERNAL	IMM	TD-SCDMA doesn't support the Line and Periodic Timer parameters. When the mode is TD-SCDMA, if the Radio Device is switched to BTS, the value will be changed to External 1 and if the Radio device is switched to MS, the value will be changed to RFBurst
SPUR	SA, WCDMA, C2K, WIMAX OFDMA, TD-SCDMA, 1xEV-DO, DVB-T/H, LTE, LTETDD, MSR	IMM	IQ not supported	
SEM	SA, WCDMA, C2K,	1xEVDO(BTS): EXTERNAL1	IQ not supported	

	WIMAX OFDMA, TD-SCDMA, 1xEVDO, DVB- T/H, DTMB, LTE, LTETDD, CMMB, ISDB-T, Digital Cable TV, MSR	All others: IMMEDIATE		
CDP	WCDMA	IMM	IMM	
RHO	WCDMA	IMM	IMM	
PCON	WCDMA	IMM	IMM	
QPSK	WCDMA, C2K, 1xEVDO	All except CDMA1xEVDO: IMMEDIATE CDMA1xEVDO: EXT1	IMM	
MON	All except SA and BASIC	IMM	IQ not supported	
WAV		LTETDD: BTS: External 1 MS: Periodic Timer GSM/EDGE: RFBurst All others: IMMEDIATE	LTETDD: BTS: External 1 MS: Periodic Timer GSM/EDGE: IQMag All others: IMMEDIATE	
PVT	WIMAXOFDMA	RFB	IMM	
EVM	WIMAXOFDMA, DVB-T/H, DTMB, LTE, LTETDD, CMMB, ISDB-T, Digital Cable TV	All but CMMB: IMM CMMB: Periodic Timer	All but CMMB: IMM CMMB: External 1	LTE, LTETDD supports Free Run, Video and External 1 only.
SPEC	BASIC	IMM	IMM	
LOG Plot	PN	IMM	IQ not supported	
Spot Freq	PN	IMM	IQ not supported	
GMSK PVT	EDGE/GSM	RFB	IMM	
GMSK PFER	EDGE/GSM	RFB	IQMag	
GMSK ORFS	EDGE/GSM	RF Burst	IQ not supported	

EDGE PVT	EDGE/GSM	RFB	IMM
EDGE EVM	EDGE/GSM	RFB	IQMag
EDGE ORFS	EDGE/GSM	Periodic Timer	IQ not supported
Combined WCDMA	WCDMA	IMM	IQ not supported
Combined GSM	EDGE/GSM	RFB	IQ not supported
List Power Step	WCDMA, EDGE/GSM	IMM	IQ not supported
Transmit On/Off Power	LTETDD	LTETDD: BTS: External 1 MS: Periodic Timer	LTETDD: BTS: External 1 MS: Periodic Timer
Transmit Analysis	BLUETOOTH	RFB	IQ not supported
Adjacent Channel Power	BLUETOOTH	IMM	IQ not supported
LE In-band Emissions	BLUETOOTH	IMM	IQ not supported
EDR In-band Spurious Emissions	BLUETOOTH	Periodic Timer	IQ not supported
Conformance EVM	LTE, LTETDD, MSR	IMM	IMM

## RF Trigger Source

The RF Trigger Source command selects the trigger to be used for the specified measurement when RF is the selected input. The RF trigger source can be queried and changed even while another input is selected, but it is inactive until RF becomes the selected input.

Note the inclusion of the <measurement> parameter in the command below. Because each measurement remembers its own Trigger Source, the command must be qualified with the measurement name. Note that for the Swept SA measurement this is not the case; for backwards compatibility, no <measurement> parameter is used when setting the Trigger Source for the Swept SA measurement.

<b>Remote Command</b>	<pre>:TRIGger:&lt;measurement&gt;[:SEquence]:RF:SOURce EXTernal1   EXTernal2   IMMediate   LINE   FRAME   RFBurst   VIDEo   IF   ALARm   LAN   TV   INTernal  :TRIGger:&lt;measurement&gt;[:SEquence]:RF:SOURce?</pre>
-----------------------	------------------------------------------------------------------------------------------------------------------------------------------------------------------------------------------------------------------------

<b>Example</b>	<p>TRIG:ACP:RF:SOUR EXT1</p> <p>Selects the external 1 trigger input for the ACP measurement and the RF input</p> <p>TRIG:RF:SOUR VID</p> <p>Selects video triggering for the SANalyzer measurement and the RF input. For SAN, do not use the &lt;measurement&gt; keyword.</p>
<b>Notes</b>	<p>Not all measurements have all the trigger sources available to them. Check the trigger source documentation for your specific measurement to see what sources are available.</p> <p>Not all trigger sources are available for each input. For the RF Trigger Source, the following trigger sources are available:</p> <ul style="list-style-type: none"> <li>–IMMediate - free run triggering</li> <li>–VIDeo - triggers on the video signal level</li> <li>–LINE - triggers on the power line signal</li> <li>–EXTernal1 (or EXTernal) - triggers on an externally connected trigger source marked “Trigger 1 In” on the rear panel</li> <li>–EXTernal2 - triggers on an externally connected trigger source marked “Trigger 2 In” on the front panel. In some models, there is no second External input. In these models, the External 2 key is blanked and the EXTernal2 parameter will generate a “Hardware missing; Not available for this model number” message</li> <li>–RFBurst - triggers on the bursted frame</li> <li>–FRAMe - triggers on the periodic timer</li> <li>–IF (video) - same as video, for backwards compatibility only</li> </ul> <p>M9420A:</p> <ul style="list-style-type: none"> <li>–INTernal - triggers on the internal source signal</li> </ul> <p>*OPC should be used after requesting data. This will hold off any subsequent changes to the selected trigger source, until after the sweep is completed and the data is returned.</p> <p>Available ranges, and presets can vary from mode to mode.</p>
<b>Status Bits/OPC dependencies</b>	<p>The Status Operation Register bit 5 “Waiting for Trigger” is set at the same time as the Sweeping or Measuring bit is set. It is cleared when the trigger actually occurs (that is, after the trigger event occurs and all the applicable trigger criteria have been met). A corresponding pop-up message (“Waiting for trigger”) is generated if no trigger signal appears after approximately 2 sec. This message goes away when a trigger signal appears.</p>
<b>Initial S/W Revision</b>	Prior to A.02.00

## I/Q Trigger Source

This command selects the trigger to be used for the specified measurement when I/Q (which requires option BBA) is the selected input. The I/Q trigger source can be queried and changed even while another input is selected, but it is inactive until I/Q becomes the selected input.

<b>Remote Command</b>	<pre>:TRIGger:&lt;measurement&gt;[:SEquence]:IQ:SOURce EXTernal1   EXTernal2   IMMediate   IQMag   IDEMod   QDEMod   IINPut   QINPut   AIQMag  :TRIGger:&lt;measurement&gt;[:SEquence]:IQ:SOURce?</pre>
-----------------------	---------------------------------------------------------------------------------------------------------------------------------------------------------------------------------------------------------

<b>Example</b>	TRIG:WAVeform:SOUR IQM
----------------	------------------------

	Selects I/Q magnitude triggering for the IQ Waveform measurement and the I/Q input
Notes	<p>Not all measurements have all the trigger sources available to them. Check the trigger source documentation for your specific measurement to see what sources are available.</p> <p>Not all trigger sources are available for each input. For the I/Q Trigger Source, the following trigger sources are available:</p> <ul style="list-style-type: none"> <li>–IMMediate - free run triggering</li> <li>–EXTernal1 (or EXTernal) - triggers on an externally connected trigger source on the rear panel</li> <li>–EXTernal2 - triggers on an externally connected trigger source on the front panel</li> <li>–IQMag - triggers on the magnitude of the I/Q signal</li> <li>–IDEMod - triggers on the I/Q signal's demodulated I voltage</li> <li>–QDEMod - triggers on the I/Q signal's demodulated Q voltage</li> <li>–IINPut - triggers on the I channel's ADC voltage</li> <li>–QINPut - triggers on the Q channel's ADC voltage</li> <li>–AIQMag - triggers on the magnitude of the auxiliary receiver channel I/Q signal</li> </ul> <p>*OPC should be used after requesting data. This will hold off any subsequent changes to the selected trigger source, until after the sweep is completed and the data is returned.</p> <p>Available ranges, and from mode to mode presets can vary</p>
Status Bits/OPC dependencies	The Status Operation Register bit 5 "Waiting for Trigger" is set at the same time as the Sweeping or Measuring bit is set. It is cleared when the trigger actually occurs (that is, after the trigger event occurs and all the applicable trigger criteria have been met). A corresponding pop-up message ("Waiting for trigger") is generated if no trigger signal appears after approximately 2 sec. This message goes away when a trigger signal appears.
Initial S/W Revision	Prior to A.02.00

## More Information

The trigger menus let you select the trigger source and trigger settings for a sweep or measurement. In triggered operation (basically, any trigger source other than Free Run), the analyzer will begin a sweep or measurement only with the selected trigger conditions are met, generally when your trigger source signal meets the specified trigger level and polarity requirements. (In FFT measurements, the trigger controls when the data acquisition begins for FFT conversion.)

For each of the trigger sources, you may define a set of operational parameters or settings which will be applied when that source is selected as the current trigger source. Examples of these settings are Trigger Level, Trigger Delay, and Trigger Slope. You may apply different settings for each source; so, for example, you could have a Trigger Level of 1v for External 1 trigger and –10 dBm for Video trigger.

Once you have established the settings for a given trigger source, they generally will remain unchanged for that trigger source as you go from measurement to measurement within a Mode (although the settings do change as you go from Mode to Mode). Furthermore, the trigger settings within a Mode are the same for the **Trigger** menu, the **Gate Source** menu, and the **Sync Source** menu that is part of the **Periodic Timer Trigger Setup** menu. That is, if Ext1 trigger level is set to 1v in the **Trigger** menu, it will appear as 1v in both the **Gate Source** and the **Sync Source** menus. For these reasons the trigger settings commands are not qualified with the measurement name, the way the trigger source commands are.

The settings setup menu can be accessed by pressing the key for the current trigger source a second time. For example, one press of Video selects the Video trigger as the source. The Video key becomes highlighted and the hollow arrow on the key turns black. Now a second press of the key takes you into the Video Trigger Setup menu.

Trigger Setup Parameters:

The following examples show trigger setup parameters using an external trigger source.

Example 1 illustrates the trigger conditions with negative slope and no trigger occurs during trigger Holdoff time.

Example 2 illustrates the trigger conditions with positive slope, trigger delay, and auto trigger time.

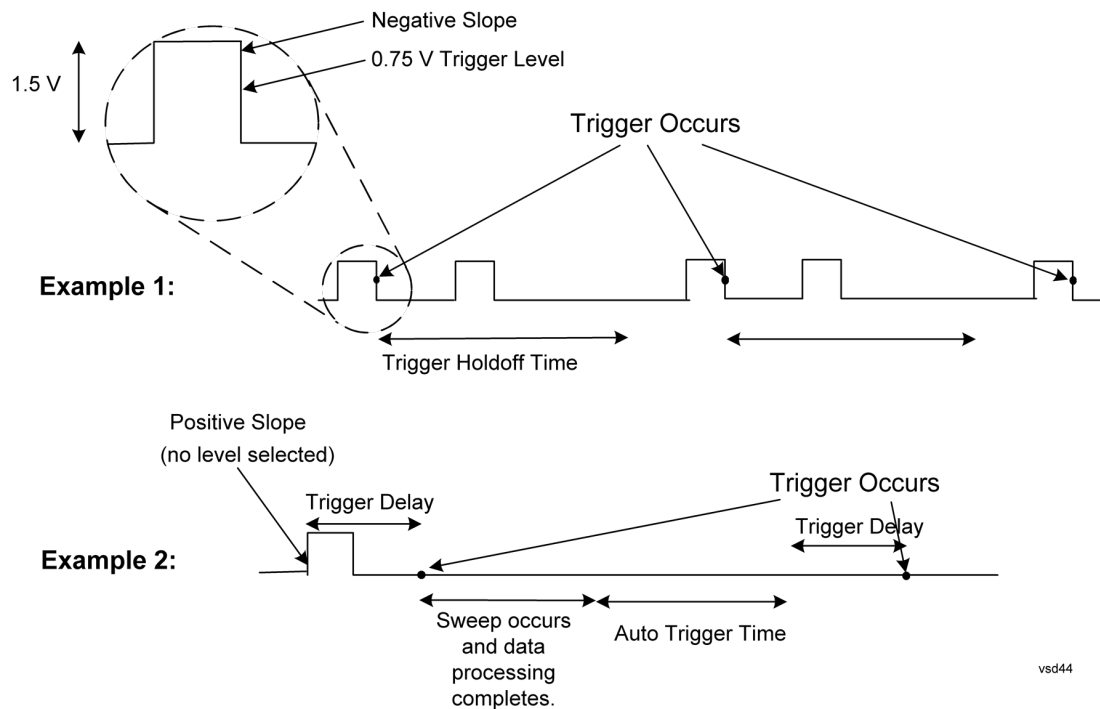

## Free Run

Pressing this key, when it is not selected, selects free-run triggering. Free run triggering occurs immediately after the sweep/measurement is initiated.

Key Path	Trigger
<b>Example</b>	TRIG:SOUR IMM Swept SA measurement TRIG:<meas>:SOUR IMM Measurements other than Swept SA
State Saved	Saved in instrument state
Status Bits/OPC dependencies	The Status Operation Register bit 5 "Waiting for Trigger" is set at the same time as the Sweeping or Measuring bit is set. It is cleared when the trigger actually occurs (that is, after the trigger event occurs and all the applicable trigger criteria have been met). A corresponding pop-up message ("Waiting for trigger") is generated if no trigger signal appears after approximately 2 sec. This

	message goes away when a trigger signal appears.
Initial S/W Revision	Prior to A.02.00

## Video (IF Envelope)

Pressing this key, when it is not selected, selects the video signal as the trigger. The Video trigger condition is met when the video signal (the filtered and detected version of the input signal, including both RBW and VBW filtering) crosses the video trigger level.

**NOTE**

When the detector selected for all active traces is the average detector, the video signal for triggering does not include any VBW filtering.

The video trigger level is shown as a labeled line on the display. The line is displayed as long as video is the selected trigger source.

Pressing this key, when it is already selected, accesses the video trigger setup functions.

Key Path	Trigger
<b>Example</b>	TRIG:SOUR VID Swept SA measurement TRIG:<meas>:SOUR VID Measurements other than Swept SA
Notes	Log Plot and Spot Frequency measurements do not support Video Trigger
Dependencies	Video trigger is allowed in average detector mode.
State Saved	Saved in instrument state
Status Bits/OPC dependencies	The Status Operation Register bit 5 "Waiting for Trigger" is set at the same time as the Sweeping or Measuring bit is set. It is cleared when the trigger actually occurs (that is, after the trigger event occurs and all the applicable trigger criteria have been met). A corresponding pop-up message ("Waiting for trigger") is generated if no trigger signal appears after approximately 2 sec. This message goes away when a trigger signal appears.
Backwards Compatibility Notes	In the past, the Average detector was not available when Video triggering was on, and consequently, functions that set the detector to average (such as Marker Noise or Band/Intvl Power) were not available when the video trigger was on. Similarly, Video triggering was not available when the detector was Average. In the X-Series, these restrictions are removed.
Initial S/W Revision	Prior to A.02.00

## Trigger Level

Sets a level for the video signal trigger. When the video signal crosses this level, with the chosen slope, the trigger occurs. This level is displayed with a horizontal line only if **Video** is the selected trigger source.

Key Path	Trigger, Video
<b>Remote Command</b>	:TRIGger[:SEquence]:VIDeo:LEVel <amp1> :TRIGger[:SEquence]:VIDeo:LEVel?



<b>Example</b>	TRIG:VID:LEV -40 dBm
Notes	<p>When sweep type = FFT, the video trigger uses the amplitude envelope in a bandwidth wider than the FFT width as a trigger source. This might often be useful, but does not have the same relationship between the displayed trace and the trigger level as in swept triggering.</p> <p>Amplitude Corrections are not taken into account by the Video Trig Level. For example, if you have given yourself effective gain with an amplitude correction factor, the Video Trigger will not fire until you have dropped the trigger line that far below the displayed signal level, rather than simply dropping it down to the displayed signal level.</p> <p>Note that other corrections, specifically External Gain and Ref Level Offset, modify the actual trace data as it is taken and therefore ARE taken into account by Trig Level.</p>
Couplings	This same level is used for the Video trigger source in the Trigger menu and for the Video selection in the Gate Source menu.
Preset	Set the Video Trigger Level -25 dBm on Preset. When the Video Trigger Level becomes the active function, if the value is off screen, set it to either the top or bottom of screen, depending on which direction off screen it was.
State Saved	Saved in instrument state
Min	-170 dBm
Max	+30 dBm
Default Unit	Depends on the current selected Y axis unit
<b>Backwards Compatibility SCPI</b>	:TRIGger[:SEquence]:IF:LEVel :TRIGger[:SEquence]:IF:LEVel?
Backwards Compatibility Notes	This alias is provided for backward compatibility with VSA/PSA comms apps.
Initial S/W Revision	Prior to A.02.00

## Trig Slope

Controls the trigger polarity. It is set positive to trigger on a rising edge and negative to trigger on a falling edge.

Key Path	Trigger, Video
<b>Remote Command</b>	:TRIGger[:SEquence]:VIDeo:SLOPe POSitive NEGative :TRIGger[:SEquence]:VIDeo:SLOPe?
<b>Example</b>	TRIG:VID:SLOP NEG
Preset	POSitive
State Saved	Saved in instrument state
<b>Backwards Compatibility SCPI</b>	:TRIGger[:SEquence]:IF:SLOPe NEGative POSitive :TRIGger[:SEquence]:IF:SLOPe?
Backwards Compatibility	For backward compatibility with VSA/PSA comms apps The legacy :TRIGger[:SEquence]:SLOPe command affects the slopes for the VID, LINE, EXT1, EXT2,

Notes	and RFB triggers.
Initial S/W Revision	Prior to A.02.00
<b>Remote Command</b>	:TRIGger[:SEquence]:SLOPe POSitive NEGative :TRIGger[:SEquence]:SLOPe?
<b>Example</b>	TRIG:SLOP NEG
Preset	POSitive
State Saved	Saved in instrument state
Backwards Compatibility Notes	In ESA/PSA, the Trigger Slope was global to all triggers. In the X-Series, the slope can be set individually for each Trigger Source. For backward compatibility, the global SLOPe command updates all instances of trigger slope (VID, LINE, EXT1, EXT2, TV, RFB). The query returns the trigger slope setting of the currently selected trigger source.
Initial S/W Revision	Prior to A.02.00

## Trig Delay

Controls a time delay during that the analyzer will wait to begin a sweep after meeting the trigger criteria. You can use negative delay to pre-trigger the instrument in the time domain or FFT, but not in swept spans.

Key Path	Trigger, Video
<b>Remote Command</b>	:TRIGger[:SEquence]:VIDeo:DELaY <time> :TRIGger[:SEquence]:VIDeo:DELaY? :TRIGger[:SEquence]:VIDeo:DELaY:STATe OFF ON 0 1 :TRIGger[:SEquence]:VIDeo:DELaY:STATe?
<b>Example</b>	TRIG:VID:DEL:STAT ON TRIG:VID:DEL 100 ms
Notes	Video trigger delay may be set to negative values, in time domain, FFT and even swept. It makes intuitive sense in time domain and works well in FFT mode where the bandwidth of the filter before the video trigger is about 1.25 span. In swept spans, negative settings of Trig Delay are treated as a zero setting within the internal hardware and the advisory message "Neg. Trig Delay unavailable in Swept Mode, zero delay used." is generated when such a delay is set.
Preset	Off, 1 us
State Saved	Saved in instrument state
Min	-150 ms
Max	+500 ms
Default Unit	s
Backwards Compatibility Notes	! For backward compatibility with VSA/PSA comms apps :TRIGger[:SEquence]:IF:DELaY :TRIGger[:SEquence]:DELaY

	The legacy :TRIGger[:SEquence]:DElay command affects the delay for the VID, LINE, EXT1, EXT2, and RFB triggers.
Initial S/W Revision	Prior to A.02.00
<b>Remote Command</b>	:TRIGger[:SEquence]:DElay <time> :TRIGger[:SEquence]:DElay? :TRIGger[:SEquence]:DElay:STATE OFF ON 0 1 :TRIGger[:SEquence]:DElay:STATE?
<b>Example</b>	TRIG:DEL 1 ms
Preset	1 us
State Saved	Saved in instrument state
Backwards Compatibility Notes	In ESA/PSA, the Trigger Delay was global to all triggers. In the X-Series, the delay can be set individually for each Trigger Source. For backward compatibility, the global DELay command updates all instances of trigger slope (VID, LINE, EXT1, EXT2) except TV and RFBurst. The query returns the trigger delay setting of the currently selected trigger source.
Initial S/W Revision	Prior to A.02.00
<b>Remote Command</b>	:TRIGger[:SEquence]:OFFSet <time> :TRIGger[:SEquence]:OFFSet? :TRIGger[:SEquence]:OFFSet:STATE OFF ON 0 1 :TRIGger[:SEquence]:OFFSet:STATE?
<b>Example</b>	TRIG:OFFS ON TRIG:OFFS -100 ms
Notes	These are ESA commands for trigger offset that allowed you to use a positive or negative delay when in zero span and in a Res BW $\geq$ 1 kHz. For ESA compatibility, X-series analyzers keep track of this offset and adds it to the Trigger Delay for VIDEo, LINE, EXTErnal1 or EXTErnal2 whenever the value is sent to the hardware, if in Zero Span and RBW $\geq$ 1 kHz.
Preset	Off, 0 s
State Saved	Saved in instrument state
Min	-11 s
Max	+11 s
Initial S/W Revision	Prior to A.02.00

## External 1

Pressing this key, when it is not selected, selects an external input signal as the trigger. A new sweep/measurement will start when the external trigger condition is met using the external 1 input connector on the rear panel.

Pressing this key, when it is already selected, accesses the external 1 trigger setup menu.

Key Path	Trigger
<b>Example</b>	TRIG:SOUR EXT1 Swept SA measurement TRIG:<meas>:SOUR EXT1 Measurements other than Swept SA
Dependencies	Grayed out if in use by Point Trigger in the Source Setup menu. Forced to Free Run if already selected and Point Trigger is set to External 1.
State Saved	Saved in instrument state
Status Bits/OPC dependencies	The Status Operation Register bit 5 "Waiting for Trigger" is set at the same time as the Sweeping or Measuring bit is set. It is cleared when the trigger actually occurs (that is, after the trigger event occurs and all the applicable trigger criteria have been met). A corresponding pop-up message ("Waiting for trigger") is generated if no trigger signal appears after approximately 2 sec. This message goes away when a trigger signal appears.
Initial S/W Revision	Prior to A.02.00

## Trigger Level

Sets the value where the external 1 trigger input will trigger a new sweep/measurement.

Key Path	Trigger, External 1
<b>Remote Command</b>	:TRIGger[:SEquence]:EXTernal1:LEVel <level> :TRIGger[:SEquence]:EXTernal1:LEVel?
<b>Example</b>	TRIG:EXT1:LEV 0.4 V
Couplings	This same level is used for the Ext1 trigger source in the Trigger menu, for the Ext1 selection in the Periodic Timer sync source (in the Trigger menu and in the Gate Source menu), and also for the Ext1 selection in the Gate Source menu.
Preset	1.2 V
State Saved	Saved in instrument state
Min	-3.5V
Max	3.5V
Default Unit	V
<b>Backwards Compatibility SCPI</b>	:TRIGger[:SEquence]:EXTernal:LEVel For backward compatibility, the parameter EXTernal is mapped to EXTernal1
<b>Backwards Compatibility SCPI</b>	:TRIGger[:SEquence]:FRAME:EXTernal1:LEVel
Initial S/W Revision	Prior to A.02.00

## Trig Slope

Controls the trigger polarity. It is set positive to trigger on a rising edge and negative to trigger on a falling edge.

Key Path	Trigger, External 1
<b>Remote Command</b>	:TRIGger[:SEquence]:EXTernal1:SLOPe POSitive NEGative :TRIGger[:SEquence]:EXTernal1:SLOPe?
<b>Example</b>	TRIG:EXT1:SLOP NEG
Couplings	This same slope is used in the Ext1 selection for the trigger source in the Trigger menu and for the period timer sync source (in the Trigger menu and in the Gate Source menu).
Preset	POSitive
State Saved	Saved in instrument state
<b>Backwards Compatibility SCPI</b>	:TRIGger[:SEquence]:EXTernal:SLOPe For backward compatibility, the parameter EXTernal is mapped to EXTernal1
<b>Backwards Compatibility SCPI</b>	:TRIGger[:SEquence]:FRAMe:EXTernal1:SLOPe
Backwards Compatibility Notes	The legacy :TRIGger[:SEquence]:SLOPe command affects the slopes for the VID, LINE, EXT1, EXT2, and RFB triggers.
Initial S/W Revision	Prior to A.02.00

## Trig Delay

Controls a time delay during which the analyzer will wait to begin a sweep after meeting the trigger criteria. You can use negative delay to pre-trigger the instrument in time domain or FFT, but not in swept spans.

Key Path	Trigger, External 1
<b>Remote Command</b>	:TRIGger[:SEquence]:EXTernal1:DELay <time> :TRIGger[:SEquence]:EXTernal1:DELay? :TRIGger[:SEquence]:EXTernal1:DELay:STATe OFF ON 0 1 :TRIGger[:SEquence]:EXTernal1:DELay:STATe?
<b>Example</b>	TRIG:EXT1:DEL:STAT ON TRIG:EXT1:DEL 100 ms
Notes	Video trigger delay may be set to negative values, in time domain, FFT and even swept. It makes intuitive sense in time domain and works well in FFT mode where the bandwidth of the filter before the video trigger is about 1.25 span. In swept spans, negative settings of Trig Delay are treated as a zero setting within the internal hardware and the advisory message "Neg. Trig Delay unavailable in Swept Mode, zero delay used." is generated when such a delay is set.
Preset	Off, 1.000 us
State Saved	Saved in instrument state
Min	-150 ms

Max	+500 ms
Default Unit	s
<b>Backwards Compatibility SCPI</b>	:TRIGger[:SEquence]:EXTernal:DELay For backward compatibility, the parameter EXTernal is mapped to EXTernal1
Backwards Compatibility Notes	The legacy :TRIGger[:SEquence]:DELay command affects the delay for the VID, LINE, EXT1, EXT2, and RFB triggers. The legacy :TRIGger[:SEquence]:OFFSet command is supported for the VIDeo, LINE, EXT1, and EXT2 triggers.
Initial S/W Revision	Prior to A.02.00

## Zero Span Delay Comp On/Off

In zero span, there is a natural delay in the signal path, which comes from the RBW filter. This is usually desirable, as it allows you to trigger on events and also see those events, because the signal is delayed from the trigger event. However, in some cases it is desirable to eliminate this delay, so that trigger events line up exactly with the zero time point in zero span. You can use the Zero Span Delay Comp On/Off feature to enable or disable zero span delay compensation.

Key Path	Trigger, External 1
<b>Remote Command</b>	:TRIGger[:SEquence]:EXTernal1:DELay:COMPensation OFF ON 0 1 :TRIGger[:SEquence]:EXTernal1:DELay:COMPensation?
<b>Example</b>	TRIG:EXT1:DEL:COMP ON
Dependencies	No effect except in zero-span, but not locked out in nonzero spans. Blanked in modes that do not support zero-span measurements. If the SCPI command is sent when the key is blanked, an error is returned: -221, "Settings conflict; Feature not supported for this measurement" In analyzers shipping N9060A, this feature requires N9060A-7FP.
Preset	OFF
State Saved	Saved in instrument state
Initial S/W Revision	A.11.00

## External 2

Pressing this key, when it is not selected, selects an external input signal as the trigger. A new sweep/measurement will start when the external trigger condition is met using the external 2 input connector. The external trigger 2 input connector is on the rear panel.

Pressing this key, when it is already selected, accesses the external 2 trigger setup menu.

Key Path	Trigger
<b>Example</b>	TRIG:SOUR EXT2      Swept SA measurement TRIG:<meas>:SOUR EXT2    Measurements other than Swept SA

Dependencies	In some models, there is no second External input. In these models, the External 2 key is blanked and the EXTernal2 parameter will generate a "Hardware missing; Not available for this model number" message. Grayed out if in use by Point Trigger in the Source Setup menu. Forced to Free Run if already selected and Point Trigger is set to External 2.
State Saved	Saved in instrument state
Status Bits/OPC dependencies	The Status Operation Register bit 5 "Waiting for Trigger" is set at the same time as the Sweeping or Measuring bit is set. It is cleared when the trigger actually occurs (that is, after the trigger event occurs and all the applicable trigger criteria have been met). A corresponding pop-up message ("Waiting for trigger") is generated if no trigger signal appears after approximately 2 sec. This message goes away when a trigger signal appears.
Initial S/W Revision	Prior to A.02.00
Modified at S/W Revision	A.03.00

## Trigger Level

Sets the value where the external 2 trigger input will trigger a new sweep/measurement.

Key Path	Trigger, External 2
<b>Remote Command</b>	:TRIGger[:SEquence]:EXTernal2:LEVel :TRIGger[:SEquence]:EXTernal2:LEVel?
<b>Example</b>	TRIG:EXT2:LEV 1.1 V
Couplings	This same level is used for the Ext2 trigger source in the Trigger menu, for the Ext2 selection in the Periodic Timer sync source (in the Trigger menu and in the Gate Source menu), and also for the Ext2 selection in the Gate Source menu.
Preset	1.2 V
State Saved	Saved in instrument state
Min	-3.5V
Max	3.5V
Default Unit	V
<b>Backwards Compatibility SCPI</b>	:TRIGger[:SEquence]:FRAMe:EXTernal2:LEVel
Initial S/W Revision	Prior to A.02.00

## Trig Slope

Controls the trigger polarity. It is set positive to trigger on a rising edge and negative to trigger on a falling edge.

Key Path	Trigger, External 2
Remote Command	:TRIGger[:SEquence]:EXTErnal2:SLOPe POSitive NEGative :TRIGger[:SEquence]:EXTErnal2:SLOPe?
Example	TRIG:EXT2:SLOP NEG
Couplings	This same slope is used in the Ext2 selection for the trigger source in the Trigger menu and for the period timer sync source (in the Trigger menu and in the Gate Source menu).
Preset	POSitive
State Saved	Saved in instrument state
Backwards Compatibility SCPI	:TRIGger[:SEquence]:FRAME:EXTErnal2:SLOPe
Backwards Compatibility Notes	The legacy :TRIGger[:SEquence]:SLOPe command affects the slopes for the VID, LINE, EXT1, EXT2, and RFB triggers.
Initial S/W Revision	Prior to A.02.00

## Trig Delay

Controls a time delay during which the analyzer will wait to begin a sweep after meeting the trigger criteria. You can use negative delay to pre-trigger the instrument in time domain or FFT, but not in swept spans.

Key Path	Trigger, External 2
Remote Command	:TRIGger[:SEquence]:EXTErnal2:DElAY <time> :TRIGger[:SEquence]:EXTErnal2:DElAY? :TRIGger[:SEquence]:EXTErnal2:DElAY:STATe OFF ON 0 1 :TRIGger[:SEquence]:EXTErnal2:DElAY:STATe?
Example	TRIG:EXT2:DEL:STAT ON TRIG:EXT2:DEL 100 ms
Notes	Video trigger delay may be set to negative values, in time domain, FFT and even swept. It makes intuitive sense in time domain and works well in FFT mode where the bandwidth of the filter before the video trigger is about 1.25 span. In swept spans, negative settings of Trig Delay are treated as a zero setting within the internal hardware and the advisory message "Neg. Trig Delay unavailable in Swept Mode, zero delay used." is generated when such a delay is set.
Preset	Off, 1.000 us
State Saved	Saved in instrument state
Min	-150 ms
Max	500 ms
Default Unit	s
Backwards Compatibility Notes	The legacy :TRIGger[:SEquence]:DElAY command affects the delay for the VID, LINE, EXT1, EXT2, and RFB triggers. The legacy :TRIGger[:SEquence]:OFFSet command is supported for the VIDEo, LINE, EXT1, and EXT2 triggers.



---

Initial S/W Revision	Prior to A.02.00
----------------------	------------------

---

## Zero Span Delay Comp On/Off

In zero span, there is a natural delay in the signal path, which comes from the RBW filter. This is usually desirable, as it allows you to trigger on events and also see those events, because the signal is delayed from the trigger event. However, in some cases it is desirable to eliminate this delay, so that trigger events line up exactly with the zero time point in zero span. You can use the Zero Span Delay Comp On/Off feature to enable or disable zero span delay compensation.

---

Key Path	Trigger, External 2
Remote Command	:TRIGger[:SEquence]:EXTernal2:DElay:COMPensation OFF ON 0 1 :TRIGger[:SEquence]:EXTernal2:DElay:COMPensation?
Example	TRIG:EXT2:DEL:COMP ON
Dependencies	No effect except in zero-span, but not locked out in nonzero spans. Blanked in modes that do not support zero-span measurements. If the SCPI command is sent when the key is blanked, an error is returned: -221, "Settings conflict; Feature not supported for this measurement" In analyzers shipping N9060A, this feature requires N9060A-7FP.
Preset	OFF
State Saved	Saved in instrument state
Initial S/W Revision	A.11.00

---

## RF Burst

Pressing this key, when it is not selected, selects the RF Burst as the trigger. A new sweep/measurement will start when an RF burst envelope signal is identified from the signal at the RF Input connector. Pressing this key, when it is already selected, accesses the RF Burst trigger setup menu.

In some models, a variety of burst trigger circuitry is available, resulting in various available burst trigger bandwidths. The analyzer automatically chooses the appropriate trigger path based on the hardware configuration and other settings of the analyzer.

---

Key Path	Trigger
Example	TRIG:SOUR RFB Swept SA measurement TRIG:<meas>:SOUR RFB Measurements other than Swept SA
State Saved	Saved in instrument state
Status Bits/OPC dependencies	The Status Operation Register bit 5 "Waiting for Trigger" is set at the same time as the Sweeping or Measuring bit is set. It is cleared when the trigger actually occurs (that is, after the trigger event occurs and all the applicable trigger criteria have been met). A corresponding pop-up message ("Waiting for trigger") is generated if no trigger signal appears after approximately 2 sec. This message goes away when a trigger signal appears.

---

Backwards Compatibility Notes	The legacy command: :TRIGger[:SEQuence]:RFBurst:FSElectivity[:STATe] OFF ON 0 1 is not supported in the X-Series, as the hardware to do Frequency Selective burst triggers does not exist in X-Series.
Initial S/W Revision	Prior to A.02.00
Modified at S/W Revision	A.04.00

## Absolute Trigger Level

Sets the absolute trigger level for the RF burst envelope.

When using the External Mixing path, the Absolute Trigger Level is uncalibrated because the factory default was set to accommodate the expected IF levels for the RF path.

Key Path	Trigger, RF Burst
Scope	Meas Global
Remote Command	:TRIGger[:SEQuence]:RFBurst:LEVel:ABSolute <ampl> :TRIGger[:SEQuence]:RFBurst:LEVel:ABSolute?
Example	TRIG:RFB:LEV:ABS 10 dBm sets the trigger level of the RF burst envelope signal to the absolute level of 10 dBm
Notes	Sending this command does not switch the setting from relative to absolute; to switch it you need to send the :TRIGger[:SEQuence]:RFBurst:LEVel:TYPE command, below. Amplitude Corrections are not taken into account by the Absolute Trigger Level. For example, if you have given yourself effective gain with an amplitude correction factor, the Absolute Trigger will not fire until you have set the trigger level that far below the displayed signal level, rather than simply to the displayed signal level. This is only true for Amplitude Corrections, not External Gain or Ref Level Offset functions. If mode is Bluetooth, the default value is -50 dBm.
Couplings	This same level is used for the RF Burst trigger source in the Trigger menu, for the RF Burst selection in the Periodic Timer sync source (in the Trigger menu and in the Gate Source menu), and also for the RF Burst selection in the Gate Source menu
Preset	-20 dBm
State Saved	Saved in instrument state
Min	-200 dBm
Max	100 dBm
Default Unit	depends on the current selected Y-Axis unit
Backwards Compatibility SCPI	:TRIGger[:SEQuence]:FRAME:RFBurst:LEVel:ABSolute
Initial S/W Revision	Prior to A.02.00
Modified at S/W Revision	A.04.00

Key Path	Trigger, RF Burst
Remote Command	:TRIGger[:SEquence]:RFBurst:LEVel:TYPE ABSolute RELative :TRIGger[:SEquence]:RFBurst:LEVel:TYPE?
Example	TRIG:RFB:LEV:TYPE REL sets the trigger level type of the RF burst trigger to Relative.
Preset	ABSolute
State Saved	Saved in instrument state
Initial S/W Revision	Prior to A.02.00
Modified at S/W Revision	A.04.00

## Relative Trigger Level

Sets the relative trigger level for the RF burst envelope.

In some models, the relative burst trigger function is implemented in hardware. In other models, without the advanced triggering hardware required, the relative burst trigger function is implemented in software in some measurements, and is unavailable in other measurements.

When implemented in software, the relative RF Burst trigger function is implemented as follows:

1. The measurement starts with the absolute RF Burst trigger setting. If it cannot get a trigger with that level, auto trigger fires and the acquisition starts anyway. After the acquisition, the measurement searches for the peak in the acquired waveform and saves it.
2. Now, in the next cycle of the measurement, the measurement determines a new absolute RF Burst level based on the peak value from the first measurement and the Relative RF Burst Trigger Level (always 0 or negative dB) set by the user. The following formula is used:
3. absolute RF Burst level = peak level of the previous acquisition + relative RF Burst level
4. If the new absolute RF Burst level differs from the previous by more than 0.5 dB, the new level is sent to the hardware; otherwise it is not updated (to avoid slowing down the acquisition)

Steps 2 and 3 repeat for subsequent measurements.

Key Path	Trigger, RF Burst
Scope	Meas Global
Remote Command	:TRIGger[:SEquence]:RFBurst:LEVel:RELative <rel_ampl> :TRIGger[:SEquence]:RFBurst:LEVel:RELative?
Example	TRIG:RFB:LEV:REL -10 dB sets the trigger level of the RF burst envelope signal to the relative level of -10 dB
Notes	Sending this command does not switch the setting from absolute to relative; to switch it you need to send the :TRIGger[:SEquence]:RFBurst:LEVel:TYPE command, above. The relative trigger level is not available in some measurements. In those measurements the RELative parameter, and the :TRIGger[:SEquence]:RFBurst:LEVel:TYPE

	command (above), will generate an error if sent.
Dependencies	This key is grayed out and Absolute Trigger Level selected if the required hardware is not present in your analyzer and the current measurement does not support Relative triggering.
Preset	-6 dB GSM: -25 dB
State Saved	Saved in instrument state
Min	-45 dB
Max	0 dB
Default Unit	dB or dBc
<b>Backwards Compatibility SCPI</b>	:TRIGger[:SEquence]:RFBurst:LEVel This legacy command is aliased to :TRIGger[:SEquence]:RFBurst:LEVel:RELative because the PSA had ONLY relative burst triggering
Initial S/W Revision	Prior to A.02.00
Modified at S/W Revision	A.04.00

## Trigger Slope

It is set positive to trigger on a rising edge and negative to trigger on a falling edge.

Key Path	Trigger, RF Burst
<b>Remote Command</b>	:TRIGger[:SEquence]:RFBurst:SLOPe POSitive NEGative :TRIGger[:SEquence]:RFBurst:SLOPe?
<b>Example</b>	TRIG:RFB:SLOP NEG
Couplings	This same slope is used in the RF Burst selection for the trigger source in the Trigger menu and for the period timer sync source (in the Trigger menu and in the Gate Source menu).
Preset	POSitive
State Saved	Saved in instrument state
<b>Backwards Compatibility SCPI</b>	:TRIGger[:SEquence]:FRAME:RFBurst:SLOPe
Backwards Compatibility Notes	The legacy :TRIGger[:SEquence]:SLOPe command affects the slopes for the VID, LINE, EXT1, EXT2, and RFB triggers.
Initial S/W Revision	Prior to A.02.00

## Trig Delay

Controls a time delay during which the analyzer will wait to begin a sweep after meeting the trigger criteria. You can use negative delay to pre-trigger the instrument in time domain or FFT, but not in swept spans.

Key Path	Trigger, RF Burst
Remote Command	:TRIGger[:SEquence]:RFBurst:DElay <time> :TRIGger[:SEquence]:RFBurst:DElay? :TRIGger[:SEquence]:RFBurst:DElay:STATE OFF ON 0 1 :TRIGger[:SEquence]:RFBurst:DElay:STATE?
Example	TRIG:RFB:DEL:STAT ON TRIG:RFB:DEL 100 ms
Notes	Video trigger delay may be set to negative values, in time domain, FFT and even swept. It makes intuitive sense in time domain and works well in FFT mode where the bandwidth of the filter before the video trigger is about 1.25 span. In swept spans, negative settings of Trig Delay are treated as a zero setting within the internal hardware and the advisory message "Neg. Trig Delay unavailable in Swept Mode, zero delay used." is generated when such a delay is set.
Preset	Off, 1.000 us
State Saved	Saved in instrument state
Min	-150 ms
Max	500 ms
Default Unit	s
Backwards Compatibility Notes	The legacy :TRIGger[:SEquence]:DElay command affects the delay for the VID, LINE, EXT1, EXT2, and RFB triggers.
Initial S/W Revision	Prior to A.02.00

## Periodic Timer (Frame Trigger)

Pressing this key, when it is not selected, selects the internal periodic timer signal as the trigger. Triggering occurrences are set by the **Period** parameter, which is modified by the **Sync Source** and **Offset**. Pressing this key, when it is already selected, accesses the periodic timer trigger setup functions.

If you do not have a sync source selected (it is Off), then the internal timer will not be synchronized with any external timing events.

Key Path	Trigger
Example	TRIG:SOUR FRAM Swept SA measurement TRIG:<meas>:SOUR FRAM Measurements other than Swept SA
State Saved	Saved in instrument state
Readback	[Sync: <value of Sync Source>], for example, [Sync: External 1]
Status Bits/OPC dependencies	The Status Operation Register bit 5 "Waiting for Trigger" is set at the same time as the Sweeping or Measuring bit is set. It is cleared when the trigger actually occurs (that is, after the trigger event occurs and all the applicable trigger criteria have been met). A corresponding pop-up message ("Waiting for trigger") is generated if no trigger signal appears after approximately 2 sec. This message goes away when a trigger signal appears.
Initial S/W Revision	Prior to A.02.00

### Periodic Timer Triggering:

This feature selects the internal periodic timer signal as the trigger. Trigger occurrences are set by the **Periodic Timer** parameter, which is modified by the **Sync Source** and **Offset**.

The figure below shows the action of the periodic timer trigger. Before reviewing the figure, we'll explain some uses for the periodic trigger.

A common application is measuring periodic burst RF signals for which a trigger signal is not easily available. For example, we might be measuring a TDMA radio which bursts every 20 ms. Let's assume that the 20 ms period is very consistent. Let's also assume that we do not have an external trigger source available that is synchronized with the period, and that the signal-to-noise ratio of the signal is not high enough to provide a clean RF burst trigger at all of the analysis frequencies. For example, we might want to measure spurious transmissions at an offset from the carrier that is larger than the bandwidth of the RF burst trigger. In this application, we can set the Periodic Timer to a 20.00 ms period and adjust the offset from that timer to position our trigger just where we want it. If we find that the 20.00 ms is not exactly right, we can adjust the period slightly to minimize the drift between the period timer and the signal to be measured.

A second way to use this feature would be to use **Sync Source** temporarily, instead of **Offset**. In this case, we might tune to the signal in a narrow span and use the RF Burst trigger to synchronize the periodic timer. Then we would turn the sync source off so that it would not miss-trigger. Miss-triggering can occur when we are tuned so far away from the RF burst trigger that it is no longer reliable.

A third example would be to synchronize to a signal that has a reference time element of much longer period than the period of interest. In some CDMA applications, it is useful to look at signals with a short periodicity, by synchronizing that periodicity to the "even-second clock" edge that happens every two seconds. Thus, we could connect the even-second clock trigger to Ext1 and use then Ext1 as the sync source for the periodic timer.

The figure below illustrates this third example. The top trace represents the even-second clock. It causes the periodic timer to synchronize with the leading edge shown. The analyzer trigger occurs at a time delayed by the accumulated offset from the period trigger event. The periodic timer continues to run, and triggers continue to occur, with a periodicity determined by the analyzer time base. The timer output (labeled "late event") will drift away from its ideal time due to imperfect matching between the time base of the signal being measured and the time base of the analyzer, and also because of imperfect setting of the period parameter. But the synchronization is restored on the next even-second clock event. ("Accumulated offset" is described in the in the **Offset** function section.)

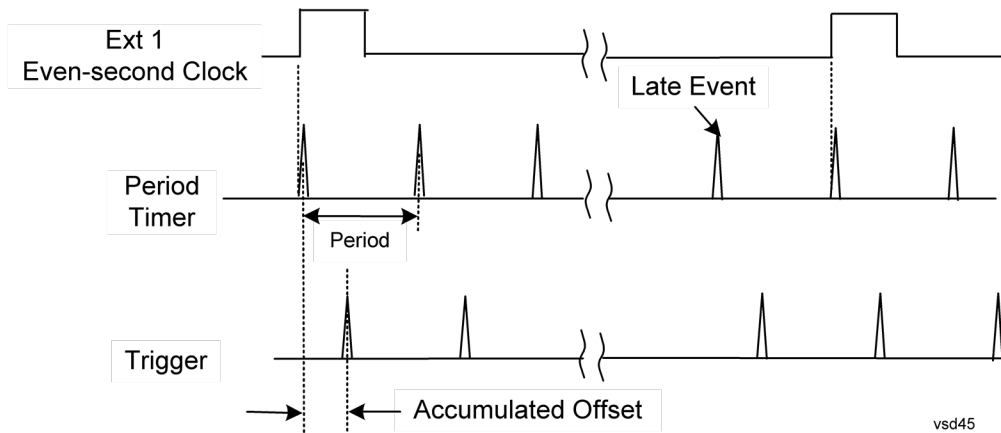

## Period

Sets the period of the internal periodic timer clock. For digital communications signals, this is usually set to the frame period of your current input signal. In the case that sync source is not set to OFF, and the external sync source rate is changed for some reason, the periodic timer is synchronized at the every external synchronization pulse by resetting the internal state of the timer circuit.

Key Path	Trigger, Periodic Timer
Remote Command	:TRIGger[:SEquence]:FRAMe:PERiod <time> :TRIGger[:SEquence]:FRAMe:PERiod?
Example	TRIG:FRAM:PER 100 ms
Dependencies	The invalid data indicator turns on when the period is changed, until the next sweep/measurement completes.
Couplings	The same period is used in the Gate Source selection of the period timer.
Preset	20 ms GSM: 4.615383
State Saved	Saved in instrument state
Min	100.000 ns
Max	559.0000 ms
Default Unit	S
Initial S/W Revision	Prior to A.02.00

## Offset

Adjusts the accumulated offset between the periodic timer events and the trigger event. Adjusting the accumulated offset is different than setting an offset, and requires explanation.

The periodic timer is usually not synchronized with any external events, so the timing of its output events has no absolute meaning. Since the timing relative to external events (RF signals) is important, you need to be able to adjust (offset) it. However, you have no direct way to see when the periodic timer events occur. All that you can see is the trigger timing. When you want to adjust the trigger timing, you will be changing

the internal offset between the periodic timer events and the trigger event. Because the absolute value of that internal offset is unknown, we will just call that the accumulated offset. Whenever the Offset parameter is changed, you are changing that accumulated offset. You can reset the displayed offset using Reset Offset Display. Changing the display does not change the value of the accumulated offset, and you can still make additional changes to accumulated offset.

To avoid ambiguity, we define that an increase in the "offset" parameter, either from the knob or the SCPI adjust command, serves to delay the timing of the trigger event.

Key Path	Trigger, Periodic Timer
Remote Command	:TRIGger[:SEquence]:FRAMe:OFFSet <time> :TRIGger[:SEquence]:FRAMe:OFFSet?
Example	TRIG:FRAM:OFFS 1.2 ms
Notes	<p>The front panel interface (for example, the knob), and this command, adjust the accumulated offset, which is shown on the active function display. However, the actual amount sent to the hardware each time the offset is updated is the delta value, that is, the current accumulated offset value minus the previous accumulated offset value. Note that the accumulated offset value is essentially arbitrary; it represents the accumulated offset from the last time the offset was zeroed (with the Reset Offset Display key).</p> <p>Note that this command does not change the period of the trigger waveform. Note also that Offset is used only when the sync source is set to OFF, otherwise delay is used, see section "<a href="#">Trig Delay</a>" on <a href="#">page 275</a>.</p> <p>An increase in the "offset" parameter, either from the knob or the SCPI adjust command, serves to delay the timing of the trigger event.</p>
Notes	<p>When the SCPI command is sent the value shown on the key (and the Active Function, if this happens to be the active function) is updated with the new value. However, the actual amount sent to the hardware is the delta value, that is, the current accumulated offset value minus the previous accumulated offset value.</p> <p>The SCPI query simply returns the value currently showing on the key.</p>
Dependencies	The invalid data indicator turns on when the offset is changed, until the next sweep/measurement completes.
Couplings	The same offset is used in the Gate Source selection of the period timer.
Preset	0 s
State Saved	Saved in instrument state
Min	-10.000 s
Max	10.000 s
Default Unit	S
Initial S/W Revision	Prior to A.02.00

## Reset Offset Display

Resets the value of the periodic trigger offset display setting to 0.0 seconds. The current displayed trigger location may include an offset value defined with the Offset key. Pressing this key redefines the currently displayed trigger location as the new trigger point that is 0.0 s offset. The Offset key can then be used to add offset relative to this new timing.



Key Path	Trigger, Periodic Timer
Remote Command	:TRIGger[:SEquence]:FRAMe:OFFSet:DISPlay:RESet
Example	TRIG:FRAM:OFFS:DISP:RES
Initial S/W Revision	Prior to A.02.00

## Sync Source

Selects a signal source for you to synchronize your periodic timer trigger to, otherwise you are triggering at some arbitrary location in the frame. Synchronization reduces the precision requirements on the setting of the period.

For convenience you may adjust the level and slope of the selected sync source in a conditional branch setup menu accessed from the Sync Source menu. Note that these settings match those in the **Trigger** and **Gate Source** menus; that is, each trigger source has only one value of level and slope, regardless of which menu it is accessed from.

Key Path	Trigger, Periodic Timer
Remote Command	:TRIGger[:SEquence]:FRAMe:SYNC EXTernal1   EXTernal2   RFBurst   OFF :TRIGger[:SEquence]:FRAMe:SYNC?
Example	TRIG:FRAM:SYNC EXT2
Dependencies	In some models, there is no second External input. In these models, the External 2 key is blanked and the EXTernal2 parameter will generate a "Hardware missing; Not available for this model number" message.
Preset	Off GSM/EDGE, MSR,LTE,LTETDD: RFBurst
State Saved	Saved in instrument state
Readback	The current setting is read back to this key and it is also Readback to the previous Periodic Timer trigger key.
Backwards Compatibility SCPI	:TRIGger[:SEquence]:FRAMe:SYNC EXTernal For backward compatibility, the parameter EXTernal is mapped to EXTernal1
Initial S/W Revision	Prior to A.02.00
Modified at S/W Revision	A.03.00, A.14.00

## Off

Turns off the sync source for your periodic trigger. With the sync source off, the timing will drift unless the signal source frequency is locked to the analyzer frequency reference.

Key Path	Trigger, Periodic Timer, Sync Source
Example	TRIG:FRAM:SYNC OFF

Readback	Off
Initial S/W Revision	Prior to A.02.00

### External 1

Pressing this key, when it is not selected, selects an external input signal as the trigger. A new sweep/measurement will start when the external trigger condition is met using the external 1 input connector on the rear panel.

Pressing this key, when it is already selected, accesses the external 1 trigger setup menu.

Key Path	Trigger
<b>Example</b>	TRIG:SOUR EXT1 Swept SA measurement TRIG:<meas>:SOUR EXT1 Measurements other than Swept SA
Dependencies	Grayed out if in use by Point Trigger in the Source Setup menu. Forced to Free Run if already selected and Point Trigger is set to External 1.
State Saved	Saved in instrument state
Status Bits/OPC dependencies	The Status Operation Register bit 5 "Waiting for Trigger" is set at the same time as the Sweeping or Measuring bit is set. It is cleared when the trigger actually occurs (that is, after the trigger event occurs and all the applicable trigger criteria have been met). A corresponding pop-up message ("Waiting for trigger") is generated if no trigger signal appears after approximately 2 sec. This message goes away when a trigger signal appears.
Initial S/W Revision	Prior to A.02.00

### Trigger Level

Sets the value where the external 1 trigger input will trigger a new sweep/measurement.

Key Path	Trigger, External 1
<b>Remote Command</b>	:TRIGger[:SEquence]:EXTernal1:LEVel <level> :TRIGger[:SEquence]:EXTernal1:LEVel?
<b>Example</b>	TRIG:EXT1:LEV 0.4 V
Couplings	This same level is used for the Ext1 trigger source in the Trigger menu, for the Ext1 selection in the Periodic Timer sync source (in the Trigger menu and in the Gate Source menu), and also for the Ext1 selection in the Gate Source menu.
Preset	1.2 V
State Saved	Saved in instrument state
Min	-3.5V
Max	3.5V

Default Unit	V
<b>Backwards Compatibility SCPI</b>	:TRIGger[:SEquence]:EXTernal:LEVel For backward compatibility, the parameter EXTernal is mapped to EXTernal1
<b>Backwards Compatibility SCPI</b>	:TRIGger[:SEquence]:FRAME:EXTernal1:LEVel
Initial S/W Revision	Prior to A.02.00

### Trig Slope

Controls the trigger polarity. It is set positive to trigger on a rising edge and negative to trigger on a falling edge.

Key Path	Trigger, External 1
<b>Remote Command</b>	:TRIGger[:SEquence]:EXTernal1:SLOPe POSitive NEGative :TRIGger[:SEquence]:EXTernal1:SLOPe?
<b>Example</b>	TRIG:EXT1:SLOP NEG
Couplings	This same slope is used in the Ext1 selection for the trigger source in the Trigger menu and for the period timer sync source (in the Trigger menu and in the Gate Source menu).
Preset	POSitive
State Saved	Saved in instrument state
<b>Backwards Compatibility SCPI</b>	:TRIGger[:SEquence]:EXTernal:SLOPe For backward compatibility, the parameter EXTernal is mapped to EXTernal1
<b>Backwards Compatibility SCPI</b>	:TRIGger[:SEquence]:FRAME:EXTernal1:SLOPe
Backwards Compatibility Notes	The legacy :TRIGger[:SEquence]:SLOPe command affects the slopes for the VID, LINE, EXT1, EXT2, and RFB triggers.
Initial S/W Revision	Prior to A.02.00

### External 2

Pressing this key, when it is not selected, selects an external input signal as the trigger. A new sweep/measurement will start when the external trigger condition is met using the external 2 input connector. The external trigger 2 input connector is on the rear panel.

Pressing this key, when it is already selected, accesses the external 2 trigger setup menu.

Key Path	Trigger
<b>Example</b>	TRIG:SOUR EXT2 Swept SA measurement TRIG:<meas>:SOUR EXT2 Measurements other than Swept SA
Dependencies	In some models, there is no second External input. In these models, the External 2 key is blanked and the EXTernal2 parameter will generate a "Hardware missing; Not available for this model number"

	message. Grayed out if in use by Point Trigger in the Source Setup menu. Forced to Free Run if already selected and Point Trigger is set to External 2.
State Saved	Saved in instrument state
Status Bits/OPC dependencies	The Status Operation Register bit 5 "Waiting for Trigger" is set at the same time as the Sweeping or Measuring bit is set. It is cleared when the trigger actually occurs (that is, after the trigger event occurs and all the applicable trigger criteria have been met). A corresponding pop-up message ("Waiting for trigger") is generated if no trigger signal appears after approximately 2 sec. This message goes away when a trigger signal appears.
Initial S/W Revision	Prior to A.02.00
Modified at S/W Revision	A.03.00

### Trigger Level

Sets the value where the external 2 trigger input will trigger a new sweep/measurement.

Key Path	Trigger, External 2
Remote Command	:TRIGger[:SEquence]:EXTernal2:LEVel :TRIGger[:SEquence]:EXTernal2:LEVel?
Example	TRIG:EXT2:LEV 1.1 V
Couplings	This same level is used for the Ext2 trigger source in the Trigger menu, for the Ext2 selection in the Periodic Timer sync source (in the Trigger menu and in the Gate Source menu), and also for the Ext2 selection in the Gate Source menu.
Preset	1.2 V
State Saved	Saved in instrument state
Min	-3.5V
Max	3.5V
Default Unit	V
Backwards Compatibility SCPI	:TRIGger[:SEquence]:FRAME:EXTernal2:LEVel
Initial S/W Revision	Prior to A.02.00

### Trig Slope

Controls the trigger polarity. It is set positive to trigger on a rising edge and negative to trigger on a falling edge.

Key Path	Trigger, External 2
----------	---------------------

<b>Remote Command</b>	:TRIGger[:SEquence]:EXTernal2:SLOPe POSitive NEGative :TRIGger[:SEquence]:EXTernal2:SLOPe?
<b>Example</b>	TRIG:EXT2:SLOP NEG
<b>Couplings</b>	This same slope is used in the Ext2 selection for the trigger source in the Trigger menu and for the period timer sync source (in the Trigger menu and in the Gate Source menu).
<b>Preset</b>	POSitive
<b>State Saved</b>	Saved in instrument state
<b>Backwards Compatibility SCPI</b>	:TRIGger[:SEquence]:FRAMe:EXTernal2:SLOPe
<b>Backwards Compatibility Notes</b>	The legacy :TRIGger[:SEquence]:SLOPe command affects the slopes for the VID, LINE, EXT1, EXT2, and RFB triggers.
<b>Initial S/W Revision</b>	Prior to A.02.00

## RF Burst

Pressing this key, when it is not selected, selects the RF Burst as the trigger. A new sweep/measurement will start when an RF burst envelope signal is identified from the signal at the RF Input connector. Pressing this key, when it is already selected, accesses the RF Burst trigger setup menu.

In some models, a variety of burst trigger circuitry is available, resulting in various available burst trigger bandwidths. The analyzer automatically chooses the appropriate trigger path based on the hardware configuration and other settings of the analyzer.

<b>Key Path</b>	Trigger
<b>Example</b>	TRIG:SOUR RFB Swept SA measurement TRIG:<meas>:SOUR RFB Measurements other than Swept SA
<b>State Saved</b>	Saved in instrument state
<b>Status Bits/OPC dependencies</b>	The Status Operation Register bit 5 "Waiting for Trigger" is set at the same time as the Sweeping or Measuring bit is set. It is cleared when the trigger actually occurs (that is, after the trigger event occurs and all the applicable trigger criteria have been met). A corresponding pop-up message ("Waiting for trigger") is generated if no trigger signal appears after approximately 2 sec. This message goes away when a trigger signal appears.
<b>Backwards Compatibility Notes</b>	The legacy command: :TRIGger[:SEquence]:RFBurst:FSElectivity[:STATe] OFF ON 0 1 is not supported in the X-Series, as the hardware to do Frequency Selective burst triggers does not exist in X-Series.
<b>Initial S/W Revision</b>	Prior to A.02.00
<b>Modified at S/W Revision</b>	A.04.00

## Absolute Trigger Level

Sets the absolute trigger level for the RF burst envelope.

When using the External Mixing path, the Absolute Trigger Level is uncalibrated because the factory default was set to accommodate the expected IF levels for the RF path.

Key Path	Trigger, RF Burst
Scope	Meas Global
<b>Remote Command</b>	:TRIGger[:SEquence]:RFBurst:LEVel:ABSolute <ampl> :TRIGger[:SEquence]:RFBurst:LEVel:ABSolute?
<b>Example</b>	TRIG:RFB:LEV:ABS 10 dBm sets the trigger level of the RF burst envelope signal to the absolute level of 10 dBm
Notes	<p>Sending this command does not switch the setting from relative to absolute; to switch it you need to send the :TRIGger[:SEquence]:RFBurst:LEVel:TYPE command, below.</p> <p>Amplitude Corrections are not taken into account by the Absolute Trigger Level. For example, if you have given yourself effective gain with an amplitude correction factor, the Absolute Trigger will not fire until you have set the trigger level that far below the displayed signal level, rather than simply to the displayed signal level. This is only true for Amplitude Corrections, not External Gain or Ref Level Offset functions.</p> <p>If mode is Bluetooth, the default value is -50 dBm.</p>
Couplings	This same level is used for the RF Burst trigger source in the Trigger menu, for the RF Burst selection in the Periodic Timer sync source (in the Trigger menu and in the Gate Source menu), and also for the RF Burst selection in the Gate Source menu
Preset	-20 dBm
State Saved	Saved in instrument state
Min	-200 dBm
Max	100 dBm
Default Unit	depends on the current selected Y-Axis unit
<b>Backwards Compatibility SCPI</b>	:TRIGger[:SEquence]:FRAME:RFBurst:LEVel:ABSolute
Initial S/W Revision	Prior to A.02.00
Modified at S/W Revision	A.04.00

Key Path	Trigger, RF Burst
<b>Remote Command</b>	:TRIGger[:SEquence]:RFBurst:LEVel:TYPE ABSolute RELative :TRIGger[:SEquence]:RFBurst:LEVel:TYPE?
<b>Example</b>	TRIG:RFB:LEV:TYPE REL sets the trigger level type of the RF burst trigger to Relative.
Preset	ABSolute
State Saved	Saved in instrument state
Initial S/W Revision	Prior to A.02.00
Modified at S/W Revision	A.04.00

## Trigger Slope

It is set positive to trigger on a rising edge and negative to trigger on a falling edge.

Key Path	Trigger, RF Burst
<b>Remote Command</b>	:TRIGger[:SEquence]:RFBurst:SLOPe POSitive NEGative :TRIGger[:SEquence]:RFBurst:SLOPe?
<b>Example</b>	TRIG:RFB:SLOP NEG
Couplings	This same slope is used in the RF Burst selection for the trigger source in the Trigger menu and for the period timer sync source (in the Trigger menu and in the Gate Source menu).
Preset	POSitive
State Saved	Saved in instrument state
<b>Backwards Compatibility SCPI</b>	:TRIGger[:SEquence]:FRAMe:RFBurst:SLOPe
Backwards Compatibility Notes	The legacy :TRIGger[:SEquence]:SLOPe command affects the slopes for the VID, LINE, EXT1, EXT2, and RFB triggers.
Initial S/W Revision	Prior to A.02.00

## Trig Delay

This setting delays the measurement timing relative to the Periodic Timer.

Key Path	Trigger, Periodic Timer
<b>Remote Command</b>	:TRIGger[:SEquence]:FRAMe:DELAy <time> :TRIGger[:SEquence]:FRAMe:DELAy? :TRIGger[:SEquence]:FRAMe:DELAy:STATe OFF ON 0 1 :TRIGger[:SEquence]:FRAMe:DELAy:STATe?
Notes	Note that delay is used when the sync source is not set to OFF. If the sync source is set to OFF, offset is used.
Preset	Off, 1.000 us
State Saved	Saved in instrument state
Min	-150 ms
Max	+500 ms
Default Unit	s
Initial S/W Revision	Prior to A.02.00

## Auto/Holdoff

Opens up a menu that lets you adjust Auto Trigger and Trigger Holdoff parameters

Key Path	Trigger
----------	---------

Readback line	<p>Displays a summary of the Auto Trig and Holdoff settings, in square brackets</p> <p>First line: Auto Off or Auto On</p> <p>Second Line: "Hldf" followed by:</p> <ul style="list-style-type: none"> <li>• If Holdoff is Off, readback Off</li> <li>• If Holdoff On and Type = Normal, readback value</li> <li>• If Holdoff On and Type = Above, readback value followed by AL</li> <li>• If Holdoff On and Type = Below, readback value followed by BL</li> <li>• If Holdoff Type selection is not supported by the current measurement, Holdoff Type is always Normal</li> </ul>
Initial S/W Revision	A.02.00

## Auto Trig

Sets the time that the analyzer will wait for the trigger conditions to be met. If they are not met after that much time, then the analyzer is triggered anyway.

Key Path	Trigger, Auto/Holdoff
Remote Command	<pre>:TRIGger[:SEquence]:ATRigger &lt;time&gt; :TRIGger[:SEquence]:ATRigger? :TRIGger[:SEquence]:ATRigger:STATe OFF ON 0 1 :TRIGger[:SEquence]:ATRigger:STATe?</pre>
Example	<pre>TRIG:ATR:STAT ON TRIG:ATR 100 ms</pre>
Notes	The "time that the analyzer will wait" starts when the analyzer is ready for a trigger, which may be hundreds of ms after the data acquisition for a sweep is done. The "time" ends when the trigger condition is satisfied, not when the delay ends.
Preset	Off, 100 ms
State Saved	Saved in instrument state
Min	1 ms
Max	100 s
Default Unit	s
Initial S/W Revision	Prior to A.02.00

## Trig Holdoff

Sets the holdoff time between triggers. When the trigger condition is satisfied, the trigger occurs, the delay begins, and the holdoff time begins. New trigger conditions will be ignored until the holdoff time expires. For a free-running trigger, the holdoff value is the minimum time between triggers.

Key Path	Trigger, Auto/Holdoff
----------	-----------------------



<b>Remote Command</b>	<pre>:TRIGger[:SEquence]:HOLDoff &lt;time&gt; :TRIGger[:SEquence]:HOLDoff? :TRIGger[:SEquence]:HOLDoff:STATe OFF ON 0 1 :TRIGger[:SEquence]:HOLDoff:STATe?</pre>
<b>Example</b>	<pre>TRIG:HOLD:STAT ON TRIG:HOLD 100 ms</pre>
<b>Dependencies</b>	Unavailable if the selected Input is BBIQ. If this is the case, the key is grayed out if it is pressed the informational message "Feature not supported for this Input" is displayed. If the SCPI command is sent, the error "Settings conflict; Feature not supported for this Input" is generated.
<b>Preset</b>	Off, 100 ms
<b>State Saved</b>	Saved in instrument state
<b>Min</b>	0 s
<b>Max</b>	0.5 s
<b>Default Unit</b>	s
<b>Initial S/W Revision</b>	Prior to A.02.00

## Internal

Pressing this key, when it is not selected, selects the signal from internal source module as the trigger. A new sweep/measurement will start when detecting the signal from internal source module.

Prerequisite of internal trigger occurring is there is trigger output from internal source. So user need configure source trigger output before selecting trigger source as internal. To enable source trigger output, output trigger should not be off if internal source works as list sequence mode and Trig 2 Out should not be off if internal source works as MXG mode. Otherwise, no trigger occurs and measurement does not start.

Note: internal trigger type is only available for M9420A.

<b>Key Path</b>	Trigger
<b>Example</b>	<pre>TRIG:SOUR INT      Swept SA measurement TRIG:&lt;meas&gt;:SOUR INT  Measurements other than Swept SA</pre>
<b>Notes</b>	See section <b>Error! Reference source not found..</b>
<b>State Saved</b>	Saved in instrument state
<b>Status Bits/OPC dependencies</b>	<p>See section <b>Error! Reference source not found..</b></p> <p>The Status Operation Register bit 5 "Waiting for Trigger" is set at the same time as the Sweeping or Measuring bit is set. It is cleared when the trigger actually occurs (that is, after the trigger event occurs and all the applicable trigger criteria have been met). A corresponding pop-up message ("Waiting for trigger") is generated if no trigger signal appears after approximately 2 sec. This message goes away when a trigger signal appears.</p>
<b>Initial S/W Revision</b>	Prior to M.16.25



## 8 Channel Power Measurement

The Channel Power measurement is used to find the total power present in a specified bandwidth. The power spectral density (the power in the signal normalized to 1 Hz) is also reported (In WLAN mode or WLAN radio standard in SA mode, the peak power spectral density for 1 MHz is reported). For measurement results and views, see ["View/Display" on page 544](#).

This topic contains the following sections:

["Measurement Commands for Channel Power" on page 280](#)

["Remote CommandResults for Channel Power Measurement" on page 281](#)

## Measurement Commands for Channel Power

These commands are used to measure the total rms power in a specified integration bandwidth.

Use `:INSTrument:SElect` to set the mode.

```
:CONFigure:CHPower
:CONFigure:CHPower:NDEFault
:INITiate:CHPower
:FETCh:CHPower[n]?
:MEASure:CHPower[n]?
:READ:CHPower[n]?
:FETCh:CHPower:CHPower?
:MEASure:CHPower:CHPower?
:READ:CHPower:CHPower?
:FETCh:CHPower:DENSity?
:MEASure:CHPower:DENSity?
:READ:CHPower:DENSity
```

For more measurement related commands, see the `SENSe` subsystem, and the section `Remote Measurement Functions@29978`.

## Remote CommandResults for Channel Power Measurement

For WLAN, see [Error! Reference source not found.](#)

Command	Return Value
FETCh:CHPower[n]?	Refer to the table below.
MEASure:CHPower[n]?	
READ:CHPower[n]?	
FETCh:CHPower:CHPower?	Returns the Channel Power (dBm) (BW compatibility functionality)
MEASure:CHPower:CHPower?	
READ:CHPower:CHPower?	
FETCh:CHPower:DENSity?	Returns the Power Spectral Density (dBm/Hz) (BW compatibility functionality)
MEASure:CHPower:DENSity?	
READ:CHPower:DENSity?	

n	Results Returned
n=1 (or not specified)	Returns scalar results: <ol style="list-style-type: none"> <li>1. Channel Power is a floating point number representing the total channel power in the specified integration bandwidth.</li> <li>2. PSD (Power Spectral Density) is the power in the specified unit bandwidth. The unit bandwidth is selected by the PSD Unit parameter in either dBm/Hz or dBm/MHz.</li> </ol>
2	Returns floating point numbers that are the captured trace data of the power (in dBm/resolution BW) of the signal. The frequency span of the captured trace data is specified by the Span key.

## Remote Command Results for WLAN Channel Power Measurement

n	Results Returned
n=1 (or not specified)	<p>Returns scalar results:</p> <p>When the radio standard is NOT WLAN 802.11ac 80 + 80 MHz:</p> <ol style="list-style-type: none"> <li>1. Channel Power is a floating point number representing the total channel power in the specified integration bandwidth.</li> <li>2. PSD (Power Spectral Density) is the power in the specified unit bandwidth. The unit bandwidth is selected by the PSD Unit parameter in either dBm/Hz or dBm/MHz.</li> </ol> <p>When the radio standard is WLAN 802.11ac 80 + 80 MHz:</p> <ol style="list-style-type: none"> <li>1. Channel Power of the carrier of which the center frequency is indicated by Freq Segment 1 is a floating point number representing the total channel power of the first segment in the specified integration bandwidth.</li> <li>2. PSD (Power Spectral Density) of the carrier of which the center frequency is indicated by Freq Segment 1 is the power in the specified unit bandwidth of the first segment. The unit bandwidth is selected by the PSD Unit parameter in either dBm/Hz or dBm/MHz.</li> <li>3. Channel Power of the carrier of which the center frequency is indicated by Freq Segment 2 is a floating point number representing the total channel power of the second segment in the specified integration bandwidth.</li> <li>4. PSD (Power Spectral Density) of the carrier of which the center frequency is indicated by Freq Segment 2 is the power in the specified unit bandwidth of the second segment. The unit bandwidth is selected by the PSD Unit parameter in either dBm/Hz or dBm/MHz.</li> </ol>
2	Returns floating point numbers that are the captured trace data of the power (in dBm/resolution BW) of the signal. The frequency span of the captured trace data is specified by the Span key.

Key Path	Meas
Mode	SA, WCDMA, C2K, WIMAX OFDMA, 1xEVDO, DVB-T/H, DTMB (CTTB), ISDB-T, CMMB, LTE, LTETDD, Digital Cable TV, WLAN, MSR, LTEAFDD, LTEATDD
Initial S/W Revision	Prior to A.02.00
Modified at S/W Revision	A.03.00

## AMPTD Y Scale

Accesses a menu of functions that enable you to set the vertical scale parameters. The parameter values are measurement independent, except all Attenuation values and the Internal Preamp selection, which are the same across all measurements.

Key Path	Front-panel key
Initial S/W Revision	Prior to A.02.00

### Ref Value

Sets the value for the absolute power reference. However, since the Auto Scaling is defaulted to On, this value is automatically determined by the measurement result. When you set a value manually, Auto Scaling automatically changes to Off.

Key Path	AMPTD Y Scale
Mode	SA, WCDMA, C2K, WIMAX OFDMA, 1xEVDO, DVB-T/H, DTMB (CTTB), ISDB-T, CMMB, LTE, LTETDD, Digital Cable TV, WLAN, MSR, LTEAFDD, LTEATDD
<b>Remote Command</b>	:DISPlay:CHPower:VIEW[1]:WINDow[1]:TRACe:Y[:SCALE]:RLEVel <real> :DISPlay:CHPower:VIEW[1]:WINDow[1]:TRACe:Y[:SCALE]:RLEVel?
<b>Example</b>	DISP:CHP:VIEW:WIND:TRAC:Y:RLEV 10 dBm DISP:CHP:VIEW:WIND:TRAC:Y:RLEV?
Notes	You must be in the Spectrum Analysis mode, W-CDMA mode, cdma2000 mode, DVB-T/H mode, DTMB (CTTB) mode, ISDB-T mode, CMMB mode, Digital Cable TV mode, LTD mode, LTE TDD mode, WLAN mode, 1xEVDO mode, MSR, LTE-Advanced FDD/TDD mode or WIMAX OFDMA mode to use this command. Use :INSTrument:SELEct to set the mode.
Couplings	When the Auto Scaling is On, this value is automatically determined by the measurement result. When you set a value manually, Auto Scaling automatically changes to Off.
Preset	10.00 dBm
State Saved	Saved in instrument state.
Min	-250.00 dBm
Max	250.00 dBm
Initial S/W Revision	Prior to A.02.00
Modified at S/W Revision	A.02.00, A.03.00

### Range

The Range menu allows setting amplitude controls of the instrument.

Key Path	AMPTD Y Scale
Scope	Meas Global
Initial S/W Revision	A.12.50

## Range

Represents the amplitude of the largest sinusoidal signal that could be present within the IF without being clipped by the ADC. For signals with high peak-to-average ratios, the range may need to exceed the rms signal power by a fair amount to avoid clipping.

Key Path	Range
Mode	BASIC
Remote Command	<code>[ :SENSe ] :POWer [ :RF ] :RANGe &lt;real&gt;</code> <code>[ :SENSe ] :POWer [ :RF ] :RANGe?</code>
Example	<code>:POW:RANG 10.0</code> <code>:POW:RANG?</code>
Notes	The MIN and MAX values are affected by the External Gain parameters, and by the Center Frequency. (The hardware compensates for frequency response and alters the Range setting.)
Preset	0
State Saved	Saved in instrument state.
Min	-100
Max	100
Initial S/W Revision	A.12.50

## Adjust Range For Min Clip

Sets the combination of attenuation and gain based on the current measured signal level so that clipping will be at a minimum.

This is an "immediate action" function, that is, it executes once, when the key is pressed.

This key is grayed out in measurements that do not support this functionality.

Key Path	AMPTD Y Scale, Attenuation
Remote Command	<code>[ :SENSe ] :POWer [ :RF ] :RANGe:OPTimize IMMEDIATE</code>
Initial S/W Revision	Prior to A.02.00
Modified at S/W Revision	A.03.00

## Pre-Adjust for Min Clip

If this function is on, it does the adjustment described under Adjust Range For Min Clip each time a measurement restarts. Therefore, in Continuous measurement mode, it only executes before the first measurement.

Key Path	AMPTD Y Scale, Attenuation
----------	----------------------------



<b>Remote Command</b>	<code>[ :SENSe ] :POWer [ :RF ] :RANGe :OPTimize :ATTenuation OFF   ON   ELECtrical   COMBined</code>  <code>[ :SENSe ] :POWer [ :RF ] :RANGe :OPTimize :ATTenuation ?</code>
Notes	This parameter is shared with old XA platform which uses AutoAtten. To keep the backward compatibility, ELECtrical and COMBined still can be used. Then, upon receiving ELECtrical and COMBined, these enums will be interpreted as aliases of ON. Then, when queried, ON will be returned.
Preset	OFF for Swept SA measurement; ON for all other measurements that support Pre-Adjust for Min Clip
State Saved	Saved in instrument state
Initial S/W Revision	Prior to A.02.00
Modified at S/W Revision	A.03.00

## Peak to Average

The Peak to Average Ratio is used with the Range setting to optimize the level control in the instrument. The value is the ratio, in dB, of the peak power to the average power of the signal to be measured. A ratio of 0 should be used for sinusoidal signals; for 802.11g OFDM signals use 9 dB.

All Applications (Modes) will show the current value of Peak to Average ratio on the softkey. However, some applications will not permit changing the value. In these situations the softkey will be grayed-out.

Key Path	AMPTD Y Scale, Range
<b>Remote Command</b>	<code>[ :SENSe ] :POWer [ :RF ] :RANGe :PARatio &lt;real&gt;</code>  <code>[ :SENSe ] :POWer [ :RF ] :RANGe :PARatio ?</code>
<b>Example</b>	POW:RANG:PAR 12 dB
Notes	In some Applications (Modes) this parameter will be read-only; meaning the value will appear on the softkey and query via SCPI, but not changeable. In such applications the softkey will be grayed-out. Attempting to change the value via SCPI will be ignored and no error message will be generated.
Preset	10 dB
State Saved	Saved in instrument state
Min	0 dB
Max	20 dB
Initial S/W Revision	A.13.00

## Mixer Level Offset

Mixer level offset is an advanced setting to adjust target Range at the input mixer which in turn affects the signal level in the instrument's IF. This setting can be used when additional optimization is needed after setting Peak to Average ratio. Positive values of offset optimize noise performance over distortion, negative values optimize distortion performance over noise.

Key Path	AMPTD Y Scale, Range
----------	----------------------

<b>Remote Command</b>	<code>[ :SENSe ] :POWer [ :RF ] :RANGe :MIXer :OFFSet &lt;real&gt;</code> <code>[ :SENSe ] :POWer [ :RF ] :RANGe :MIXer :OFFSet?</code>
<b>Example</b>	<code>POW:RANG:MIX:OFFS -5 dB</code>
<b>Preset</b>	0 dB
<b>State Saved</b>	Saved in instrument state
<b>Min</b>	-35 dB
<b>Max</b>	30 dB
<b>Initial S/W Revision</b>	A.13.00

## Scale/Div

Sets the units per division of the vertical scale in the logarithmic display. However, since the Auto Scaling is defaulted to On, this value is automatically determined by the measurement result. When you set a value manually, Auto Scaling automatically changes to Off.

<b>Key Path</b>	AMPTD Y Scale
<b>Mode</b>	SA, WCDMA, C2K, WIMAX OFDMA, 1xEVDO, DVB-T/H, DTMB (CTTB), ISDB-T, CMMB, LTE, LTETDD, Digital Cable TV, WLAN, MSR, LTEAFDD, LTEATDD
<b>Remote Command</b>	<code>:DISPlay:CHPower:VIEW[1]:WINDow[1]:TRACe:Y[:SCALe]:PDIVision &lt;rel_amp1&gt;</code> <code>:DISPlay:CHPower:VIEW[1]:WINDow[1]:TRACe:Y[:SCALe]:PDIVision?</code>
<b>Example</b>	<code>DISP:CHP:VIEW:WIND:TRAC:Y:PDIV 2</code> <code>DISP:CHP:VIEW:WIND:TRAC:Y:PDIV?</code>
<b>Notes</b>	You must be in the Spectrum Analysis mode, W-CDMA mode, cdma2000 mode, DVB-T/H mode, DTMB (CTTB) mode, ISDB-T mode, CMMB mode, Digital Cable TV mode, LTE mode, LTE TDD mode, WLAN mode, 1xEVDO mode, MSR, LTE-Advanced FDD/TDD mode or WIMAX OFDMA mode to use this command. Use <code>:INSTrument:SElect</code> to set the mode.
<b>Couplings</b>	When the Auto Scaling is On, this value is automatically determined by the measurement result. When you set a value manually, Auto Scaling automatically changes to Off.
<b>Preset</b>	10.00 dB
<b>State Saved</b>	Saved in instrument state.
<b>Min</b>	0.10 dB
<b>Max</b>	20.00 dB
<b>Initial S/W Revision</b>	Prior to A.02.00
<b>Modified at S/W Revision</b>	A.02.00, A.03.00

## Ref Position

Positions the reference level at the top, center, or bottom of the Y Scale display. Changing the reference position does not change the reference level value.

Key Path	AMPTD Y Scale
Mode	SA, WCDMA, C2K, WIMAX OFDMA, 1xEVDO, DVB-T/H, DTMB (CTTB), ISDB-T, CMMB, LTE, LTE-TDD, Digital Cable TV, WLAN, MSR, LTEAFDD, LTEATDD
<b>Remote Command</b>	:DISPlay:CHPower:VIEW[1]:WINDow[1]:TRACe:Y[:SCALe]:RPOSition TOP   CENTER   BOTTom :DISPlay:CHPower:VIEW[1]:WINDow[1]:TRACe:Y[:SCALe]:RPOSition?
<b>Example</b>	DISP:CHP:VIEW:WIND:TRAC:Y:RPOS CENT DISP:CHP:VIEW:WIND:TRAC:Y:RPOS?
Notes	You must be in the Spectrum Analysis mode, W-CDMA mode, cdma2000 mode, DVB-T/H mode, DTMB (CTTB) mode, ISDB-T mode, CMMB mode, Digital Cable TV mode, LTE mode, LTE TDD mode, WLAN mode, 1xEVDO mode, MSR, LTE-Advanced FDD/TDD mode or WIMAX OFDMA mode to use this command. Use :INSTRument:SElect to set the mode.
Preset	TOP
State Saved	Saved in instrument state.
Range	Top Ctr Bot
Initial S/W Revision	Prior to A.02.00
Modified at S/W Revision	A.02.00, A.03.00

## Auto Scaling

Toggles the Auto Scaling function between On and Off.

Key Path	AMPTD Y Scale
Mode	SA, WCDMA, C2K, WIMAX OFDMA, 1xEVDO, DVB-T/H, DTMB (CTTB), ISDB-T, CMMB, LTE, LTE-TDD, Digital Cable TV, WLAN, MSR, LTEAFDD, LTEATDD
<b>Remote Command</b>	:DISPlay:CHPower:VIEW[1]:WINDow[1]:TRACe:Y[:SCALe]:COUPle 0   1   OFF   ON :DISPlay:CHPower:VIEW[1]:WINDow[1]:TRACe:Y[:SCALe]:COUPle?
<b>Example</b>	DISP:CHP:VIEW:WIND:TRAC:Y:COUP OFF DISP:CHP:VIEW:WIND:TRAC:Y:COUP?
Couplings	When Auto Scaling is On, and the Restart front-panel key is pressed, this function automatically sets the scale per division to 10 dB and determines the reference values based on the measurement results. When you set a value to either Scale/Div or Ref Value manually, Auto Scaling automatically changes to Off.
Preset	1
State Saved	Saved in instrument state.
Range	On Off
Initial S/W Revision	Prior to A.02.00
Modified at S/W Revision	A.02.00, A.03.00

## Auto Couple

The Auto Couple feature provides a quick and convenient way to automatically couple multiple instrument settings. This helps ensure accurate measurements and optimum dynamic range. When the Auto Couple feature is activated, either from the front panel or remotely, all parameters of the current measurement that have an Auto/Manual mode are set to Auto mode and all measurement settings dependent on (or coupled to) the Auto/Man parameters are automatically adjusted for optimal performance.

However, the Auto Couple key actions are confined to the current measurement only. It does not affect other measurements in the mode, and it does not affect markers, marker functions, or trace or display attributes.

See "[More Information](#)" on page 288

<b>Key Path</b>	Front-panel key
<b>Remote Command</b>	:COUPLe ALL NONE
<b>Example</b>	:COUP ALL
<b>Notes</b>	:COUPLe ALL puts all Auto/Man parameters in Auto mode (equivalent to pressing the Auto Couple key). :COUPLE NONE puts all Auto/Man parameters in manual mode. It decouples all the coupled instrument parameters and is not recommended for making measurements.
<b>Initial S/W Revision</b>	Prior to A.02.00

### More Information

There are two types of functions that have Auto/Manual modes.

#### Auto/Man Active Function keys

An Auto/Man toggle key controls the binary state associated with an instrument parameter by toggling between Auto (where the parameter is automatically coupled to the other parameters it is dependent upon) and Man (where the parameter is controlled independent of the other parameters), as well as making the parameter the active function. The current mode is indicated on the softkey with either Auto or Man underlined as illustrated below.

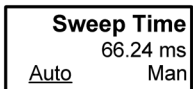

vsd07

#### Auto/Man 1-of-N keys

An Auto/Man 1-of-N key allows you to manually pick from a list of parameter values, or place the function in Auto, in which case the value is automatically selected (and indicated) as shown below. If in Auto, Auto is underlined on the calling key. If in manual operation, manual is indicated on the calling key. But the calling key does not actually toggle the function, it simply opens the menu.

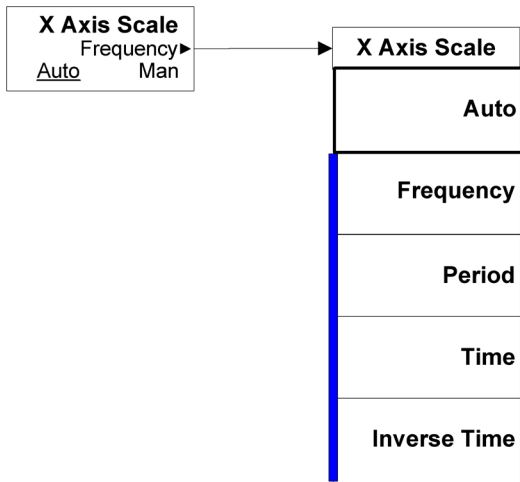

vsd08

## BW

Accesses a menu of functions that enable you to specify and control the video and resolution bandwidths. You can also select the type of filter for the measurement and set the filter bandwidth.

Key Path	Front-panel key
Initial S/W Revision	Prior to A.02.00

## Res BW

Sets the value of the resolution bandwidth (RBW). If an unavailable bandwidth is entered with the numeric keypad, the closest available bandwidth is selected.

LTE-Advanced FDD/TDD Auto RBW:

Bandwidth	RBW (KHz)
1.4MHz	20
3MHz	43
5MHz	68
10MHz	150
15MHz	220
20MHz	270

the resolution bandwidth is predefined based on the corresponding bandwidth of the single LTE carrier, which is listed above. When ResBW mode is Auto, the narrowest RBW over the active carriers is selected for Multi-carriers.

Key Path	BW
Mode	SA, WCDMA, C2K, WIMAX OFDMA, 1xEVDO, DVB-T/H, DTMB (CTTB), ISDB-T, CMMB, LTE, LTETDD, Digital Cable TV, WLAN, MSR, LTEAFDD, LTEATDD
<b>Remote Command</b>	[:SENSe]:CHPower:BANDwidth[:RESolution] <bandwidth> [:SENSe]:CHPower:BANDwidth[:RESolution]? [:SENSe]:CHPower:BANDwidth[:RESolution]:AUTO ON OFF 1 0 [:SENSe]:CHPower:BANDwidth[:RESolution]:AUTO?
<b>Example</b>	CHP:BAND 5 MHz CHP:BAND? CHP:BAND:AUTO ON CHP:BAND:AUTO?
Notes	You must be in the Spectrum Analysis mode, W-CDMA mode, cdma2000 mode, DVB-T/H mode, DTMB (CTTB) mode, ISDB-T mode, CMMB mode, Digital Cable TV mode, LTE mode, LTE TDD mode, WLAN mode, 1xEVDO mode, MSR, LTE-Advanced FDD/TDD mode or WIMAX OFDMA mode to use this command. Use :INSTrument:SElect to set the mode.

Couplings	<p>Sweep time is coupled to the RBW. As the RBW changes, the sweep time (if set to Auto) is changed to maintain amplitude calibration.</p> <p>Video bandwidth (VBW) is coupled to the RBW. As the resolution bandwidth changes, the video bandwidth (if set to Auto) changes to maintain the ratio of VBW/RBW (10:1).</p> <p>When the Res BW is set to Auto, the resolution bandwidth is auto-coupled to the span. The ratio of Span/RBW is approximately 106:1 when auto coupled. When Res BW is set to Man, and the bandwidths are entered manually, these bandwidths are used regardless of other analyzer settings.</p>
Preset	<p>SA: Auto</p> <p>WCDMA: 240 kHz</p> <p>C2K: 24 kHz</p> <p>WIMAX OFDMA: 100kHz</p> <p>1xEVDO: 30kHz</p> <p>DVB-T/H: 3.9kHz</p> <p>DTMB (CTTB): 3.9kHz</p> <p>ISDB-T: 30kHz</p> <p>CMMB: 3.9kHz</p> <p>LTE: Auto</p> <p>LTETDD: Auto</p> <p>Digital Cable TV: 3.9kHz</p> <p>WLAN: 100 kHz</p> <p>MSR: 100kHz</p> <p>LTEAFDD/LTEATDD: Auto</p> <p>WCDMA, C2K, 1xEVDO, WIMAX OFDMA, DVB-T/H, DTMB (CTTB), ISDB-T, CMMB, Digital Cable TV, WLAN, MSR: OFF</p> <p>SA, LTE, LTETDD, LTEAFDD, LTEATDD: ON</p>
State Saved	Saved in instrument state.
Min	1 Hz
Max	8 MHz
<b>Backwards Compatibility SCPI</b>	[ :SENSe ] :CHPower:BWIDth[:RESolution]
Initial S/W Revision	Prior to A.02.00
Modified at S/W Revision	A.02.00, A.03.00

## Video BW

Changes the analyzer post-detection filter (VBW).

Key Path	BW
Mode	SA, WCDMA, C2K, WIMAX OFDMA, 1xEVDO, DVB-T/H, DTMB (CTTB), ISDB-T, CMMB, LTE, LTETDD, Digital Cable TV, WLAN, MSR, LTEAFDD, LTEATDD
<b>Remote Command</b>	[ :SENSe ] :CHPower:BAWIDth:VIDeo <bandwidth>

	<pre>[ :SENSe ] :CHPower:BAWdwidth:VIDeo? [ :SENSe ] :CHPower:BAWdwidth:VIDeo:AUTO ON OFF 1 0 [ :SENSe ] :CHPower:BAWdwidth:VIDeo:AUTO?</pre>
<b>Example</b>	<pre>CHP:BAWd:VID 2.4 MHz CHP:BAWd:VID? CHP:BAWd:VID:AUTO OFF CHP:BAWd:VID:AUTO?</pre>
<b>Notes</b>	<p>You must be in the Spectrum Analysis mode, W-CDMA mode, cdma2000 mode, DVB-T/H mode, DTMB (CTTB) mode, ISDB-T mode, CMMB mode, Digital Cable TV mode, LTE mode, LTE TDD mode, WLAN mode, 1xEVDO mode, MSR,LTE-Advanced FDD/TDD mode or WIMAX OFDMA mode to use this command. Use :INSTrument:SElect to set the mode.</p>
<b>Dependencies</b>	See Couplings
<b>Couplings</b>	<p>Video bandwidth (VBW) is coupled to the RBW. As the resolution bandwidth changes, the video bandwidth (if set to Auto) changes to maintain the ratio set by VBW/RBW.</p> <p>Sweep Time is coupled to the Video Bandwidth (VBW). As the VBW is changed, the sweep time (when set to Auto) is changed to maintain amplitude calibration. This occurs because of common hardware between the two circuits, even though the Video BW filter is not actually “in-circuit” when the detector is set to Average. Because the purpose of the average detector and the VBW filter are the same, either can be used to reduce the variance of the result.</p> <p>Although the VBW filter is not “in-circuit” when using the average detector, the Video BW key can have an effect on (Auto) sweep time, and is not disabled. In this case, reducing the VBW setting increases the sweep time, which increases the averaging time, producing a lower-variance trace.</p> <p>When using the average detector with either Sweep Time set to Man, or in zero span, the VBW setting has no effect and is disabled (grayed out).</p> <p>When the video bandwidth is AUTO coupled, the video bandwidth value is set to:      Resolution Bandwidth * Video Bandwidth to Resolution Bandwidth Ratio</p>
<b>Preset</b>	<pre>SA: Auto WCDMA: 2.4MHz C2K: 240 kHz WIMAX OFDMA: Auto 1xEVDO: 300 kHz DVB-T/H: 39kHz DTMB (CTTB): 39kHz ISDB-T: 300kHz CMMB: 39kHz LTE, MSR: Auto LTETDD: Auto LTEAFDD,LTEATDD:Auto Digital Cable TV: 39kHz WLAN: Auto ON</pre>



State Saved	Saved in instrument state.
Min	1 Hz
Max	50 MHz
Initial S/W Revision	Prior to A.02.00
Modified at S/W Revision	A.02.00, A.03.00

## Filter Type

Selects the type of bandwidth filter that is used. The choices are Gaussian or Flat top.

Key Path	BW
Mode	SA, WCDMA, C2K, WIMAX OFDMA, 1xEVDO, DVB-T/H, DTMB (CTTB), ISDB-T, CMMB, LTE, LTE-TDD, Digital Cable TV, WLAN, MSR, LTEAFDD, LTEATDD
<b>Remote Command</b>	[ :SENSe ] :CHPower :BANDwidth :SHAPE GAUSSian FLATtop [ :SENSe ] :CHPower :BANDwidth :SHAPE?
<b>Example</b>	CHP:BAND:SHAP GAUS CHP:BAND:SHAP?
Preset	GAUSSian
State Saved	Saved in instrument state.
Range	Gaussian Flattop
<b>Backwards Compatibility SCPI</b>	[ :SENSe ] :CHPower :BWIDth :SHAPE
Initial S/W Revision	Prior to A.02.00
Modified at S/W Revision	A.02.00, A.03.00

## Cont (Continuous Measurement/Sweep)

Sets the analyzer for Continuous measurement operation. The single/continuous state is Meas Global so the setting will affect all measurements. If you are Paused, pressing Cont does a Resume.

<b>Key Path</b>	Front-panel key
<b>Remote Command</b>	:INITiate:CONTinuous OFF ON 0 1 :INITiate:CONTinuous?
<b>Example</b>	:INIT:CONT 0 puts analyzer in Single measurement operation. :INIT:CONT 1 puts analyzer in Continuous measurement operation
<b>Preset</b>	ON (Note that SYST:PRESet sets INIT:CONT to ON but *RST sets INIT:CONT to OFF)
<b>State Saved</b>	Saved in instrument state
<b>Backwards Compatibility Notes</b>	For Spectrum Analysis mode in ESA and PSA, there is no Cont hardkey, instead there is a Sweep Single/Cont key. In these analyzers, switching the Sweep Single/Cont key from Single to Cont restarts averages (displayed average count reset to 1), but does not restart Max Hold and Min Hold. The X-Series has Single and Cont keys in place of the SweepSingleCont key. In the X-Series, if in single measurement, the Cont key (and INIT:CONT ON ) switches to continuous measurement, but never restarts a measurement and never resets a sweep.
<b>Initial S/W Revision</b>	Prior to A.02.00

In Swept SA Measurement (Spectrum Analysis Mode):

The analyzer takes repetitive sweeps, averages, measurements, etc., when in Continuous mode. When the average count reaches the Average/Hold Number the count stops incrementing, but the analyzer keeps sweeping. See the Trace/Detector section for the averaging formula used both before and after the Average/Hold Number is reached. The trigger condition must be met prior to each sweep. The type of trace processing for multiple sweeps, is set under the Trace/Detector key, with choices of Trace Average, Max Hold, or Min Hold.

In Other Measurements/Modes:

With Avg/Hold Num (in the Meas Setup menu) set to Off or set to On with a value of 1, a sweep is taken after the trigger condition is met; and the analyzer continues to take new sweeps after the current sweep has completed and the trigger condition is again met. However, with Avg/Hold Num set to On with a value >1, multiple sweeps (data acquisitions) are taken for the measurement. The trigger condition must be met prior to each sweep. The sweep is not stopped when the average count k equals the number N set for Avg/Hold Num is reached, but the number k stops incrementing. A measurement average usually applies to all traces, marker results, and numeric results. But sometimes it only applies to the numeric results.

If the analyzer is in Single measurement, pressing the Cont key does not change k and does not cause the sweep to be reset; the only action is to put the analyzer into Continuous measurement operation.

If it is already in continuous sweep:

the INIT:CONT 1 command has no effect

the INIT:CONT 0 command will place the analyzer in Single Sweep but will have no effect on the current sequence until  $k = N$ , at which point the current sequence will stop and the instrument will go to the idle state.

8 Channel Power Measurement  
File

File

See "File" on page 178

## FREQ Channel

Accesses a menu of keys that allow you to control the Frequency and Channel parameters of the instrument.

Some features in the Frequency menu are the same for all measurements – they do not change as you change measurements. Settings like these are called “Meas Global” and are unaffected by Meas Preset. For example, the Center Freq setting is the same for all measurements – it does not change as you change measurements.

Key Path	Front-panel key
Initial S/W Revision	Prior to A.02.00

### Center Freq

Sets the frequency that corresponds to the horizontal center of the graticule (when frequency Scale Type is set to linear). While adjusting the Center Frequency the Span is held constant, which means that both Start Frequency and Stop Frequency will change.

Pressing Center Freq also sets the frequency entry mode to Center/Span. In Center/Span mode, the center frequency and span values are displayed below the graticule, and the default active function in the Frequency menu is Center Freq.

The center frequency setting is the same for all measurements within a mode, that is, it is Meas Global. Some modes are also able to share a Mode Global center frequency value. If this is the case, the Mode will have a Global Settings key in its Mode Setup menu.

The Center Freq function sets (and queries) the Center Frequency for the currently selected input. If your analyzer has multiple inputs, and you select another input, the Center Freq changes to the value for that input. SCPI commands are available to directly set the Center Freq for a specific input.

Center Freq is remembered as you go from input to input. Thus you can set a Center Freq of 10 GHz with the RF Input selected, change to BBIQ and set a Center Freq of 20 MHz, then switch to External Mixing and set a Center Freq of 60 GHz, and when you go back to the RF Input the Center Freq will go back to 10 GHz; back to BBIQ and it is 20 MHz; back to External Mixing and it is 60 GHz.

See ["RF Center Freq" on page 300](#)

See [Ext Mix Center Freq](#)

See ["I/Q Center Freq" on page 302](#)

See ["Center Frequency Presets" on page 298](#)

Key Path	FREQ Channel
Scope	Meas Global
Remote Command	[ :SENSe ] :FREQuency:CENTer <freq> [ :SENSe ] :FREQuency:CENTer?
Example	FREQ:CENT 50 MHz

	FREQ:CENT UP changes the center frequency to 150 MHz if you use FREQ:CENT:STEP 100 MHz to set the center frequency step size to 100 MHz FREQ:CENT?
Notes	This command sets either the RF or I/Q Center Frequency depending on the selected input. For RF input it is equivalent to FREQ:RF:CENT For I/Q input it is equivalent to FREQ:IQ:CENT Preset and Max values are dependent on Hardware Options (5xx) If no terminator (e.g. MHz) is sent the terminator Hz is used. If a terminator with unit other than Frequency is used, an invalid suffix error message is generated.
Dependencies	The Center Frequency can be limited by Start or Stop Freq limits, if the Span is so large that Start or Stop reach their limit.
Couplings	When operating in "swept span", any value of the Center Frequency or Span that is within the frequency range of the analyzer is allowed when the value is being set through the front panel numeric key pad or the SCPI command. The other parameter is forced to a different value if needed, to keep the Start and the Stop Frequencies within the analyzer's frequency range
Preset	Depends on instrument maximum frequency, mode, measurement, and selected input. See " <a href="#">Center Frequency Presets</a> " on page 298 and " <a href="#">RF Center Freq</a> " on page 300 and <a href="#">Ext Mix Center Freq</a> and " <a href="#">I/Q Center Freq</a> " on page 302.
State Saved	Saved in instrument state
Min	Depends on instrument maximum frequency, mode, measurement, and selected input.. See " <a href="#">Center Frequency Presets</a> " on page 298 and " <a href="#">RF Center Freq</a> " on page 300 and " <a href="#">I/Q Center Freq</a> " on page 302.
Max	Depends on instrument maximum frequency, mode, measurement, and selected input.. See " <a href="#">Center Frequency Presets</a> " on page 298 and " <a href="#">RF Center Freq</a> " on page 300 and " <a href="#">I/Q Center Freq</a> " on page 302.
Default Unit	Hz
Status Bits/OPC	Non-overlapped
Dependencies	
Initial S/W Revision	Prior to A.02.00

## Center Frequency Presets

The following table provides the Center Frequency Presets for the Spectrum Analyzer mode, and the Max Freq, for the various frequency options:

Freq Option	CF after Mode Preset	Stop Freq after Mode Preset	Max Freq (can't tune above)

503 (all but N9000A)	1.805 GHz	3.6 GHz	3.7 GHz
503 (N9000A)	1.505 GHz	3.0 GHz	3.08 GHz
504 (M9420A)	1 GHz	3.8GHz	3.88 GHz
506 (M9420A)	1 GHz	6.0GHz	6.08 GHz
507 (all but N9000A)	3.505 GHz	7.0 GHz	7.1 GHz
507 (N9000A)	3.755 GHz	7.5 GHz	7.58 GHz
508 (all but N9038A)	1.805 GHz	3.6 GHz	8.5 GHz
508 (N9038A)	4.205 GHz	8.4 GHz	8.5 GHz
513	6.805 GHz	13.6 GHz	13.8 GHz
526 (all but N9000A and N9038A)	13.255 GHz	26.5 GHz	27.0 GHz
526 (N9000A)	13.255 GHz	26.5 GHz	26.55 GHz
526 (N9038A)	1.805 GHz	3.6 GHz	27.0 GHz
532	16.005 GHz	32.0 GHz	32.5 GHz
543	21.505 GHz	43.0 GHz	TBD
544	22.005 GHz	44.0 GHz	44.5 GHz
550	25.005 GHz	50.0 GHz	51 GHz

Input 2:

Model	CF after Mode Preset	Stop Freq after Mode Preset	Max Freq (can't tune above)
N9000A opt C75	0.7505GHz	1.5 GHz	1.58 GHz
N9038A	505 MHz	1 GHz	1.000025 GHz

Tracking Generator Frequency Limits (N9000A only):

Tracking Generator Option	Min Freq (clips to this freq when turn TG on and can't tune below while TG on)	If above this Freq, Stop Freq clipped to this Freq when TG turned on	Max Freq (can't tune above) while TG on
T03	9 kHz	3.0 GHz	3.08 GHz
T06	9 kHz	6.0 GHz	6.05 GHz

The following table shows the Center Frequency Presets for modes other than Spectrum Analyzer:

Mode	CF Preset for RF
WCDMA	1 GHz
WIMAXOFDMA,	1 GHz
BASIC	1 GHz
ADEMOD	1 GHz
VSA	1 GHz
TDSCDMA	1 GHz
PNOISE	1 GHz
LTE	1 GHz
LTETDD	1 GHz
MSR	1 GHz
GSM	935.2 MHz
NFIGURE	1.505 GHz

## RF Center Freq

SCPI command for specifying the RF Center Frequency. This command will set the Center Frequency to be used when the RF input is selected, even if the RF input is not the input that is selected at the time the command is sent. Note that the Center Freq function in the Frequency menu on the front panel always applies to the currently selected input.

Scope	Meas Global
<b>Remote Command</b>	<code>[ :SENSe ] :FREQuency:RF:CENTer &lt;freq&gt;</code> <code>[ :SENSe ] :FREQuency:RF:CENTer?</code>
<b>Example</b>	FREQ:RF:CENT 30 MHz
Notes	This command is the same in all modes, but the parameter is Measurement Global. So the value is independent in each mode and common across all the measurements in the mode.
Dependencies	If the electronic/soft attenuator is enabled, any attempt to set Center Frequency such that the Stop Frequency would be >3.6 GHz fails and results in an advisory message. If the equivalent SCPI



	command is sent, this same message is generated as part of a “-221, Settings conflict” warning. If Source Mode is set to Tracking, and the Max or Min Center Freq is therefore limited by the limits of the source, a warning message is generated, “Data out of range;clipped to source max/min” if these limits are exceeded. Note that for an external source, these limits can be affected by the settings of Source Numerator, Source Denominator and Power Sweep.
Preset	See table above
State Saved	Saved in instrument state.
Min	-79.999995 MHz, unless Source Mode is set to Tracking, in which case it is limited by the minimum frequency of the Source
Max	See table above. Basically instrument maximum frequency - 5 Hz. Note that, if the Source Mode is set to Tracking, the effective instrument maximum frequency may be limited by the source maximum frequency. If the knob or step keys are being used, also depends on the value of the other three interdependent parameters Span, Start Frequency and Stop Frequency
Initial S/W Revision	Prior to A.02.00
Modified at S/W Revision	A.03.00

## Ext Mix Center Freq

SCPI command for specifying the External Mixer Center Frequency. This command will set the Center Frequency to be used when the External Mixer is selected, even if the External Mixer input is not the input which is selected at the time the command is sent. Note that the Center Freq function in the Frequency menu on the front panel always applies to the currently selected input.

Scope	Meas Global
<b>Remote Command</b>	<code>[ :SENSe ] :FREQuency:EMIXer:CENTer &lt;freq&gt;</code> <code>[ :SENSe ] :FREQuency:EMIXer:CENTer?</code>
<b>Example</b>	<code>:FREQ:EMIX:CENT 60 GHz</code> <code>:FREQ:EMIX:CENT?</code>
Notes	This command is the same in all modes, but the parameter is Measurement Global. So the value is independent in each mode and common across all the measurements in the mode.
Couplings	When returning to External Mixing after having been switched to one of the other inputs (e.g., RF), you will come back into the settings that you had when you left External Mixing. So you will come back to the band you were in with the Center Frequency that you had. However, Span is not an input-dependent parameter, therefore you will bring the span over from the other input. Therefore, the analyzer comes back with the span from the previous input, limited as necessary by the current mixer setup.
Preset	When a Mode Preset is performed while in External Mixing, the Start frequency of the current Mode is set to the nominal Min Freq of the lowest harmonic range in the Harmonic Table for the current mixer setup. Similarly, the Stop frequency of the current Mode is set to the nominal Max Freq of the highest harmonic range in the Harmonic Table. The Center Freq thus presets to the point arithmetically equidistant from these two frequencies.

	<p>If the current measurement has a limited Span available to it, and cannot achieve the Span shown in the table (Span=Stop Freq – Start Freq), the analyzer uses the maximum Span the measurement allows, and still sets the Center Freq to the midpoint of the Start and Stop Freq values in the Harmonic Table.</p> <p>When Restore Input/Output Defaults is performed, the mixer presets to the 11970A, whose Start and Stop frequencies are 26.5 and 40 GHz respectively. The center of these two frequencies is 33.25 GHz.</p> <p>Therefore, after a Restore Input/Output Defaults, if you go into External Mixing and do a Mode Preset while in the Spectrum Analyzer Mode, the resulting Center Freq is 33.25 GHz.</p>
State Saved	Saved in instrument state.
Min	The minimum frequency in the currently selected mixer band + 5 Hz
Max	The maximum frequency in the currently selected mixer band – 5 Hz If the knob or step keys are being used, also depends on the value of the other three interdependent parameters Span, Start Frequency and Stop Frequency
Initial S/W Revision	A.08.01

### I/Q Center Freq

SCPI command for specifying the I/Q Center Frequency. This command will set the Center Frequency to be used when the I/Q input is selected, even if the I/Q input is not the input which is selected at the time the command is sent. Note that the Center Freq function in the Frequency menu on the front panel always applies to the currently selected input.

Scope	Meas Global
<b>Remote Command</b>	[ :SENSe ] :FREQuency:IQ:CENTer <freq> [ :SENSe ] :FREQuency:IQ:CENTer?
<b>Example</b>	FREQ:IQ:CENt: 30 MHz
Notes	This command is the same in all modes, but the parameter is Measurement Global. So the value is independent in each mode and common across all the measurements in the mode.
Preset	0 Hz
State Saved	Saved in instrument state.
Min	-40.049995 MHz
Max	40.049995 MHz
Initial S/W Revision	Prior to A.02.00

## Input/Output

See ["Input/Output" on page 118](#)

## Marker

Accesses a menu that enables you to select, set up and control the markers for the current measurement.

Key Path	Front-panel key
Initial S/W Revision	Prior to A.02.00

### Select Marker

Displays 12 markers available for selection.

Key Path	Marker
Initial S/W Revision	Prior to A.02.00

### Marker Type

Sets the marker control mode to Normal, Delta, Fixed or Off. All interactions and dependencies detailed under the key description are enforced when the remote command is sent. If the selected marker is Off, pressing Marker sets it to Normal and places it at the center of the screen on the trace determined by the Marker Trace rules. At the same time, Marker X Axis Value appears on the Active Function area.

The default active function is the active function for the currently selected marker control mode. If the current control mode is Off, there is no active function and the active function is turned off.

Key Path	Marker
Mode	SA, WCDMA, C2K, WIMAX OFDMA, 1xEVDO, DVB-T/H, DTMB (CTTB), ISDB-T, CMMB, LTE, LTETDD, Digital Cable TV, WLAN, MSR, LTEAFDD, LTEATDD
Remote Command	:CALCulate:CHPower:MARKer[1] 2 ... 12:MODE POSITION   DELTa   OFF :CALCulate:CHPower:MARKer[1] 2 ... 12:MODE?
Example	CALC:CHP:MARK3:MODE POS CALC:CHP:MARK3:MODE?
Notes	If the selected marker is Off, pressing Marker sets it to Normal and places it at the center of the screen on the trace determined by the Marker Trace rules. At the same time, Marker X Axis Value appears on the Active Function area.  Default Active Function: the active function for the selected marker's current control mode. If the current control mode is Off, there is no active function and the active function is turned off.  Active Function Display: the marker X axis value entered in the active function area displays the marker value to its full entered precision.
Preset	OFF
State Saved	Saved in instrument state.
Range	Normal Delta Off

Initial S/W Revision	Prior to A.02.00
Modified at S/W Revision	A.02.00, A.03.00

## Properties

Accesses the marker properties menu.

Key Path	Marker
Initial S/W Revision	Prior to A.02.00

## Select Marker

Displays 12 markers available for selection.

Key Path	Marker
Initial S/W Revision	Prior to A.02.00

## Relative To

Sets the reference marker to which the selected marker is relative.

Key Path	Marker, Properties
Mode	SA, WCDMA, C2K, WIMAX OFDMA, 1xEVDO, DVB-T/H, DTMB (CTTB), ISDB-T, CMMB, LTE, LTETDD, Digital Cable TV, WLAN, MSR, LTEAFDD, LTEATDD
<b>Remote Command</b>	:CALCulate:CHPower:MARKer[1] 2 ... 12:REFerence <integer> :CALCulate:CHPower:MARKer[1] 2 ... 12:REFerence?
<b>Example</b>	CALC:CHP:MARK:REF 5 CALC:CHP:MARK:REF?
Notes	A marker cannot be relative to itself so that choice is grayed out, and if sent from SCPI generates error -221: "Settings conflict; marker cannot be relative to itself." When queried, a single value is returned (the specified marker numbers relative marker). You must be in the Spectrum Analysis or WCDMA mode to use this command. Use :INSTrument:SElect to set the mode.
Preset	2 3 4 5 6 7 8 9 10 11 12 1
State Saved	Saved in instrument state.
Min	1
Max	12
Initial S/W Revision	Prior to A.02.00
Modified at S/W Revision	A.02.00, A.03.00

## All Markers Off

Turns off all markers.

Key Path	Marker
Mode	SA, WCDMA, C2K, WIMAX OFDMA, 1xEVDO, DVB-T/H, DTMB (CTTB), ISDB-T, CMMB, LTE, LTETDD, Digital Cable TV, WLAN, MSR, LTEAFDD, LTEATDD
<b>Remote Command</b>	:CALCulate:CHPower:MARKer:AOFF
<b>Example</b>	CALC:CHP:MARK:AOFF
Initial S/W Revision	Prior to A.02.00
Modified at S/W Revision	A.02.00, A.03.00

## Marker X Axis Value (Remote Command Only)

Sets the marker X Axis value in the current marker X Axis Scale unit. It has no effect if the control mode is Off, but is the SCPI equivalent of entering an X value if the control mode is Normal, Delta, or Fixed.

Mode	SA, WCDMA, CDMA2K, WIMAXOFDMA, CDMA1XEV, DVB, DTMB, ISDBT, CMMB, LTE, LTETDD, DCATV, WLAN, MSR, LTEAFDD, LTEATDD
<b>Remote Command</b>	:CALCulate:CHPower:MARKer[1] 2 ... 12:X <real> :CALCulate:CHPower:MARKer[1] 2 ... 12:X?
<b>Example</b>	CALC:CHP:MARK3:X 0 CALC:CHP:MARK3:X?
Notes	The query returns the marker's absolute X Axis value if the control mode is Normal, or the offset from the marker's reference marker if the control mode is Delta. The query is returned in the fundamental units for the current marker X Axis scale: Hz for Frequency.
Preset	After a preset, all markers are turned OFF, so Marker X Axis Value query returns a not a number (NAN).
State Saved	Saved in instrument state.
Min	-9.9E+37
Max	9.9E+37
Initial S/W Revision	Prior to A.02.00
Modified at S/W Revision	A.02.00, A.03.00

## Marker X Axis Position (Remote Command Only)

Sets the marker X Axis Scale position in trace points. This setting has no effect if the control mode is Off, but is the SCPI equivalent of entering a value if the control mode is Normal or Delta. The entered value is immediately translated into the current X Axis Scale units for setting the value of the marker.

Mode	SA, WCDMA, CDMA2K, WIMAXOFDMA, CDMA1XEV, DVB, DTMB, ISDBT, CMMB, LTE, LTETDD, DCATV, WLAN, MSR, LTEAFDD, LTEATDD
------	------------------------------------------------------------------------------------------------------------------

<b>Remote Command</b>	:CALCulate:CHPower:MARKer[1] 2 ... 12:X:POStion <real> :CALCulate:CHPower:MARKer[1] 2 ... 12:X:POStion?
<b>Example</b>	CALC:CHP:MARK10:X:POS 0 CALC:CHP:MARK10:X:POS?
<b>Notes</b>	The query returns the marker's absolute X Axis value in trace points if the control mode is Normal, or the offset from the marker's reference marker in trace points if the control mode is Delta.
<b>Preset</b>	After a preset, all markers are turned OFF, so Marker X Axis Value query returns a not a number (NAN).
<b>State Saved</b>	Saved in instrument state.
<b>Min</b>	-9.9E+37
<b>Max</b>	9.9E+37
<b>Initial S/W Revision</b>	Prior to A.02.00
<b>Modified at S/W Revision</b>	A.02.00, A.03.00

### Marker Y Axis Value (Remote Command only)

Returns the marker Y Axis value in the current marker Y Axis unit.

<b>Mode</b>	SA, WCDMA, CDMA2K, WIMAXOFDMA, CDMA1XEV, DVB, DTMB, ISDBT, CMMB, LTE, LTETDD, DCATV, WLAN, MSR, LTEAFDD, LTEATDD
<b>Remote Command</b>	:CALCulate:CHPower:MARKer[1] 2 ... 12:Y?
<b>Example</b>	CALC:CHP:MARK11:Y?
<b>Preset</b>	Result dependent on Markers setup and signal source.
<b>State Saved</b>	Saved in instrument state.
<b>Initial S/W Revision</b>	Prior to A.02.00
<b>Modified at S/W Revision</b>	A.02.00, A.03.00

### Backward Compatibility SCPI Commands

Sets or queries the state of a marker. Setting a marker which is OFF to state ON or 1 puts it in Normal mode and places it at the center of the screen.

<b>Mode</b>	SA, WCDMA, CDMA2K, WIMAXOFDMA, CDMA1XEV, DVB, DTMB, ISDBT, CMMB, LTE, LTETDD, DCATV, WLAN, MSR, LTEAFDD, LTEATDD
<b>Remote Command</b>	:CALCulate:CHPower:MARKer[1] 2 ... 12:STATe OFF ON 0 1 :CALCulate:CHPower:MARKer[1] 2 ... 12:STATe?
<b>Example</b>	CALC:CHP:MARK3:STAT ON CALC:CHP:MARK3:STAT?
<b>Preset</b>	OFF

8 Channel Power Measurement  
Marker

State Saved	Saved in instrument state.
Range	On Off
Initial S/W Revision	Prior to A.02.00
Modified at S/W Revision	A.02.00, A.03.00



## Marker Function

There are no 'Marker Functions' supported in Channel Power, so this front-panel key displays a blank menu when pressed.

---

Key Path	Front-panel key
Initial S/W Revision	Prior to A.02.00

---

## Marker To

There is no 'Marker To' functionality supported in Channel Power measurement, so this front-panel key displays a blank key menu when pressed.

---

Key Path	Front-panel key
Initial S/W Revision	Prior to A.02.00

---

## Meas

The information in this section is common to all measurements. For key and remote command information for a specific measurement, refer to the section that describes the measurement of interest.

Measurements available under the Meas key are specific to the current Mode.

When viewing Help for measurements, note the following:

**NOTE**

Operation for some keys differs between measurements. The information displayed in Help pertains to the current measurement. To see how a key operates in a different measurement, exit Help (press the Cancel Esc key), select the measurement, then reenter Help (press the Help key) and press that key.

---

Key Path	Front-panel key
Initial S/W Revision	Prior to A.02.00

---

### Remote Measurement Functions

This section contains the following topics:

"Measurement Group of Commands" on page 1269

"Current Measurement Query (Remote Command Only)" on page 1271

"Limit Test Current Results (Remote Command Only)" on page 1271

"Data Query (Remote Command Only)" on page 1271

"Calculate/Compress Trace Data Query (Remote Command Only)" on page 1272

"Calculate Peaks of Trace Data (Remote Command Only)" on page 1277

"Hardware-Accelerated Fast Power Measurement (Remote Command Only)" on page 1278

"Format Data: Numeric Data (Remote Command Only)" on page 1292

"Format Data: Byte Order (Remote Command Only)" on page 1293

---

Initial S/W Revision	Prior to A.02.00
----------------------	------------------

---

## Measurement Group of Commands

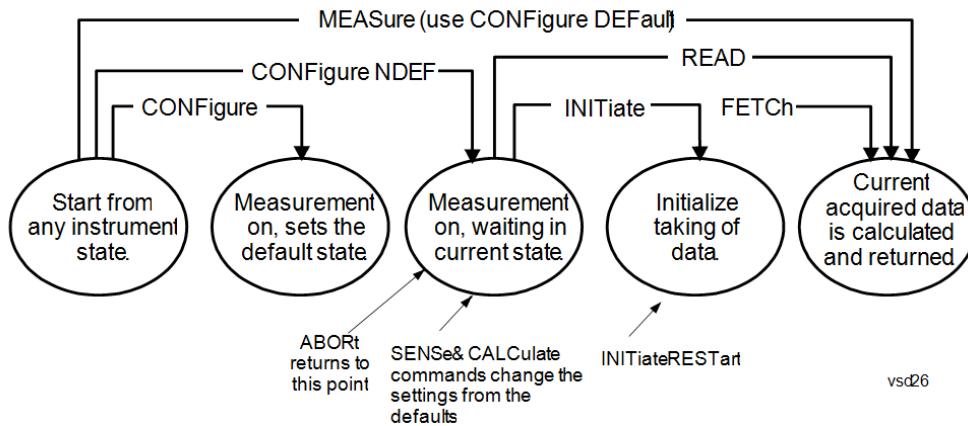

---

### Measure Commands:

:MEASure:<measurement>[n]?

This is a fast single-command way to make a measurement using the factory default instrument settings. These are the settings and units that conform to the Mode Setup settings (e.g. radio standard) that you have currently selected.

- Stops the current measurement (if any) and sets up the instrument for the specified measurement using the factory defaults
- Initiates the data acquisition for the measurement
- Blocks other SCPI communication, waiting until the measurement is complete before returning results.
- If the function does averaging, it is turned on and the number of averages is set to 10.
- After the data is valid it returns the scalar results, or the trace data, for the specified measurement. The type of data returned may be defined by an [n] value that is sent with the command.
- The scalar measurement results will be returned if the optional [n] value is not included, or is set to 1. If the [n] value is set to a value other than 1, the selected trace data results will be returned. See each command for details of what types of scalar results or trace data results are available.
- ASCII is the default format for the data output. (Older versions of Spectrum Analysis and Phase Noise mode measurements only use ASCII.) The binary data formats should be used for handling large blocks of data since they are smaller and faster than the ASCII format. Refer to the FORMat:DATA command for more information.

If you need to change some of the measurement parameters from the factory default settings you can set up the measurement with the CONFigure command. Use the commands in the SENSE:<measurement> and CALCulate:<measurement> subsystems to change the settings. Then you can use the READ? command to initiate the measurement and query the results.

If you need to repeatedly make a given measurement with settings other than the factory defaults, you can use the commands in the SENSE:<measurement> and CALCulate:<measurement> subsystems to set up the measurement. Then use the READ? command to initiate the measurement and query results.

Measurement settings persist if you initiate a different measurement and then return to a previous one. Use READ:<measurement>? if you want to use those persistent settings. If you want to go back to the default settings, use MEASure:<measurement>?.

---

### Configure Commands:

:CONFigure:<measurement>

This command stops the current measurement (if any) and sets up the instrument for the specified measurement using

---

---

the factory default instrument settings. It does not initiate the taking of measurement data unless INIT:CONTInuous is ON. If you change any measurement settings after using the CONFigure command, the READ command can be used to initiate a measurement without changing the settings back to their defaults.

In the Swept SA measurement in Spectrum Analyzer mode the CONFigure command also turns the averaging function on and sets the number of averages to 10 for all measurements.

:CONFigure: <measurement>: NDEFault stops the current measurement and changes to the specified measurement. It does not change the settings to the defaults. It does not initiate the taking of measurement data unless INIT:CONTInuous is ON.

The CONFigure? query returns the current measurement name.

The CONFigure:CATalog? query returns a quoted string of all licensed measurement names in the current mode. For example, "SAN, CHP, OBW, ACP, PST, TXP, SPUR, SEM, LIST".

---

#### Fetch Commands:

:FETCh:<measurement>[n]?

This command puts selected data from the most recent measurement into the output buffer. Use FETCh if you have already made a good measurement and you want to return several types of data (different [n] values, for example, both scalars and trace data) from a single measurement. FETCh saves you the time of re-making the measurement. You can only FETCh results from the measurement that is currently active, it will not change to a different measurement. An error message is reported if a measurement other than the current one is specified.

If you need to get new measurement data, use the READ command, which is equivalent to an INITiate followed by a FETCh.

The scalar measurement results will be returned if the optional [n] value is not included, or is set to 1. If the [n] value is set to a value other than 1, the selected trace data results will be returned. See each command for details of what types of scalar results or trace data results are available. The binary data formats should be used for handling large blocks of data since they are smaller and transfer faster than the ASCII format. (FORMat:DATA)

FETCh may be used to return results other than those specified with the original READ or MEASure command that you sent.

---

#### INITiate Commands:

:INITiate:<measurement>

This command is not available for measurements in all the instrument modes:

- Initiates a trigger cycle for the specified measurement, but does not output any data. You must then use the FETCh<meas> command to return data. If a measurement other than the current one is specified, the instrument will switch to that measurement and then initiate it.
- For example, suppose you have previously initiated the ACP measurement, but now you are running the channel power measurement. If you send INIT:ACP? it will change from channel power to ACP and will initiate an ACP measurement.
- Does not change any of the measurement settings. For example, if you have previously started the ACP measurement and you send INIT:ACP? it will initiate a new ACP measurement using the same instrument settings as the last time ACP was run.
- If your selected measurement is currently active (in the idle state) it triggers the measurement, assuming the trigger conditions are met. Then it completes one trigger cycle. Depending upon the measurement and the number of averages, there may be multiple data acquisitions, with multiple trigger events, for one full trigger cycle. It also holds off additional commands on GPIB until the acquisition is complete.

---

#### READ Commands:

:READ:<measurement>[n]?

- Does not preset the measurement to the factory default settings. For example, if you have previously initiated the ACP
-

---

measurement and you send READ:ACP? it will initiate a new measurement using the same instrument settings.

- Initiates the measurement and puts valid data into the output buffer. If a measurement other than the current one is specified, the instrument will switch to that measurement before it initiates the measurement and returns results.
  - For example, suppose you have previously initiated the ACP measurement, but now you are running the channel power measurement. Then you send READ:ACP? It will change from channel power back to ACP and, using the previous ACP settings, will initiate the measurement and return results.
  - Blocks other SCPI communication, waiting until the measurement is complete before returning the results
  - If the optional [n] value is not included, or is set to 1, the scalar measurement results will be returned. If the [n] value is set to a value other than 1, the selected trace data results will be returned. See each command for details of what types of scalar results or trace data results are available. The binary data formats should be used when handling large blocks of data since they are smaller and faster than the ASCII format. (FORMat:DATA)
- 

---

Initial S/W Revision	Prior to A.02.00
----------------------	------------------

---

### Current Measurement Query (Remote Command Only)

This command returns the name of the measurement that is currently running.

---

<b>Remote Command</b>	:CONFigure?
-----------------------	-------------

<b>Example</b>	CONF?
----------------	-------

Initial S/W Revision	Prior to A.02.00
----------------------	------------------

---

### Limit Test Current Results (Remote Command Only)

Queries the status of the current measurement limit testing. It returns a 0 if the measured results pass when compared with the current limits. It returns a 1 if the measured results fail any limit tests.

---

<b>Remote Command</b>	:CALCulate:CLIMits:FAIL?
-----------------------	--------------------------

<b>Example</b>	CALC:CLIM:FAIL? queries the current measurement to see if it fails the defined limits. Returns a 0 or 1: 0 it passes, 1 it fails.
----------------	--------------------------------------------------------------------------------------------------------------------------------------

Initial S/W Revision	Prior to A.02.00
----------------------	------------------

---

### Data Query (Remote Command Only)

Returns the designated measurement data for the currently selected measurement and subopcode.

n = any valid subopcode for the current measurement. See the measurement command results table for your current measurement, for information about what data is returned for the subopcodes.

This command uses the data setting specified by the FORMat:BORDER and FORMat:DATA commands and can return real or ASCII data. (See the format command descriptions under Input/Output in the Analyzer Setup section.)

<b>Remote Command</b>	:CALCulate:DATA[n]?
<b>Notes</b>	The return trace depends on the measurement. In CALCulate:<meas>:DATA[n], n is any valid subopcode for the current measurement. It returns the same data as the FETCH:<measurement>? query where <measurement> is the current measurement.
<b>Initial S/W Revision</b>	Prior to A.02.00

### Calculate/Compress Trace Data Query (Remote Command Only)

Returns compressed data for the currently selected measurement and sub-opcode [n].

n = any valid sub-opcode for that measurement. See the MEASure:<measurement>? command description of your specific measurement for information on the data that can be returned.

The data is returned in the current Y Axis Unit of the analyzer. The command is used with a sub-opcode <n> (default=1) to specify the trace. With trace queries, it is best if the analyzer is not sweeping during the query. Therefore, it is generally advisable to be in Single Sweep, or Update=Off.

This command is used to compress or decimate a long trace to extract and return only the desired data. A typical example would be to acquire N frames of GSM data and return the mean power of the first burst in each frame. The command can also be used to identify the best curve fit for the data.

<b>Remote Command</b>	:CALCulate:DATA<n>:COMPRESS? BLOCK   CFIT   MAXimum   MINimum   MEAN   DMEan   RMS   RMSCubed   SAMPLE   SDEVIation   PPHase [,<soffset> [,<length>[,<roffset>[,<rlimit>]]]]
<b>Example</b>	To query the mean power of a set of GSM bursts: Supply a signal that is a set of GSM bursts. Select the IQ Waveform measurement (in IQ Analyzer Mode). Set the sweep time to acquire at least one burst. Set the triggers such that acquisition happens at a known position relative to a burst. Then query the mean burst levels using, CALC:DATA2:COMP? MEAN, 24e-6, 526e-6 (These parameter values correspond to GSM signals, where 526e-6 is the length of the burst in the slot and you just want 1 burst.)
<b>Notes</b>	The command supports 5 parameters. Note that the last 4 (<soffset>, <length>, <roffset>, <rlimit>) are optional. But these optional parameters must be entered in the specified order. For example, if you want to specify <length>, then you must also specify <soffset>. See details below for a definition of each of these parameters.  This command uses the data in the format specified by FORMat:DATA, returning either binary or ASCII data.
<b>Initial S/W Revision</b>	Prior to A.02.00

- BLOCK or block data - returns all the data points from the region of the trace data that you specify. For example, it could be used to return the data points of an input signal over several timeslots, excluding the portions of the trace data that you do not want. (This is x,y pairs for trace data and I,Q pairs for complex data.)

- CFIT or curve fit - applies curve fitting routines to the data. <soffset> and <length> are required to define the data that you want. <roffset> is an optional parameter for the desired order of the curve equation. The query will return the following values: the x-offset (in seconds) and the curve coefficients ((order + 1) values).

MIN, MAX, MEAN, DME, RMS, RMSC, SAMP, SDEV and PPH return one data value for each specified region (or <length>) of trace data, for as many regions as possible until you run out of trace data (using <roffset> to specify regions). Or they return the number of regions you specify (using <rlimit>) ignoring any data beyond that.

- MINimum - returns the minimum data point (y value) for the specified region(s) of trace data. For I/Q trace data, the minimum magnitude of the I/Q pairs is returned.
- MAXimum - returns the maximum data point (y value) for the specified region(s) of trace data. For I/Q trace data, the maximum magnitude of the I/Q pairs is returned.
- MEAN - returns a single value that is the arithmetic mean of the data point values (in dB/ dBm) for the specified region(s) of trace data. For I/Q trace data, the mean of the magnitudes of the I/Q pairs is returned. See the following equations.

**NOTE** If the original trace data is in dB, this function returns the arithmetic mean of those log values, not log of the mean power which is a more useful value. The mean of the log is the better measurement technique when measuring CW signals in the presence of noise. The mean of the power, expressed in dB, is useful in power measurements such as Channel Power. To achieve the mean of the power, use the RMS option.

Equation 1

Mean Value of Data Points for Specified Region(s)

$$\text{MEAN} = \frac{1}{n} \sum_{X_i \in \text{region}(s)} X_i$$

where  $X_i$  is a data point value, and  $n$  is the number of data points in the specified region(s).

Equation 2

Mean Value of I/Q Data Pairs for Specified Region(s)

$$\text{MEAN} = \frac{1}{n} \sum_{X_i \in \text{region}(s)} |X_i|$$

where  $|X_i|$  is the magnitude of an I/Q pair, and  $n$  is the number of I/Q pairs in the specified region(s).

- DMEan - returns a single value that is the mean power (in dB/ dBm) of the data point values for the specified region(s) of trace data. See the following equation:

Equation 3

DMEan Value of Data Points for Specified Region(s)



$$\text{DME} = 10 \times \log_{10} \left( \frac{1}{n} \sum_{X_i \in \text{region}(s)} 10^{\frac{X_i}{10}} \right)$$

- RMS - returns a single value that is the average power on a root-mean-squared voltage scale (arithmetic rms) of the data point values for the specified region(s) of trace data. See the following equation.

**NOTE** For I/Q trace data, the rms of the magnitudes of the I/Q pairs is returned. See the following equation. This function is very useful for I/Q trace data. However, if the original trace data is in dB, this function returns the rms of the log values which is not usually needed.

Equation 4

RMS Value of Data Points for Specified Region(s)

$$\text{RMS} = \sqrt{\frac{1}{n} \sum_{X_i \in \text{region}(s)} X_i^2}$$

where  $X_i$  is a data point value, and  $n$  is the number of data points in the specified region(s).

Equation 5

RMS Value of I/Q Data Pairs for Specified Region(s)

$$\text{RMS} = \sqrt{\frac{1}{n} \sum_{X_i \in \text{region}(s)} X_i X_i^*}$$

where  $X_i$  is the complex value representation of an I/Q pair,  $X_i^*$  its conjugate complex number, and  $n$  is the number of I/Q pairs in the specified region(s).

Once you have the rms value for a region of trace data (linear or I/Q), you may want to calculate the mean power. You must convert this rms value (peak volts) to power in dBm:

$$10 \times \log[10 \times (\text{rms value})^2]$$

- SAMPlE - returns the first data value (x,y pair) for the specified region(s) of trace data. For I/Q trace data, the first I/Q pair is returned.
- SDEViation - returns a single value that is the arithmetic standard deviation for the data point values for the specified region(s) of trace data. See the following equation.
- For I/Q trace data, the standard deviation of the magnitudes of the I/Q pairs is returned. See the following equation.

Equation 6

Standard Deviation of Data Point Values for Specified Region(s)

$$\text{SDEV} = \sqrt{\frac{1}{n} \sum_{X_i \in \text{region}(s)} (X_i - \bar{X})^2}$$

where  $X_i$  is a data point value,  $\bar{X}$  is the arithmetic mean of the data point values for the specified region (s), and  $n$  is the number of data points in the specified region(s).

$$\text{SDEV} = \sqrt{\frac{1}{n} \sum_{X_i \in \text{region}(s)} (|X_i| - \bar{X})^2}$$

where  $|X_i|$  is the magnitude of an I/Q pair,  $\bar{X}$  is the mean of the magnitudes for the specified region(s), and  $n$  is the number of data points in the specified region(s).

- PPHase - returns the x,y pairs of both rms power (dBm) and arithmetic mean phase (radian) for every specified region and frequency offset (Hz). The number of pairs is defined by the specified number of regions. This parameter can be used for I/Q vector ( $n=0$ ) in Waveform (time domain) measurement and all parameters are specified by data point in PPHase.

The rms power of the specified region may be expressed as:

$$\text{Power} = 10 \times \log [10 \times (\text{RMS I/Q value})] + 10.$$

The RMS I/Q value (peak volts) is:

$$\sqrt{\frac{1}{n} \sum_{X_i \in \text{region}} X_i X_i^*}$$

where  $X_i$  is the complex value representation of an I/Q pair,  $X_i^*$  its conjugate complex number, and  $n$  is the number of I/Q pairs in the specified region.

The arithmetic mean phase of the specified region may be expressed as:

$$\frac{1}{n} \sum_{Y_i \in \text{region}} Y_i$$

where  $Y_i$  is the unwrapped phase of I/Q pair with applying frequency correction and  $n$  is the number of I/Q pairs in the specified region.

The frequency correction is made by the frequency offset calculated by the arithmetic mean of every specified region's frequency offset. Each frequency offset is calculated by the least square method against the unwrapped phase of I/Q pair.

Sample Trace Data - Constant Envelope

(See below for explanation of variables.)

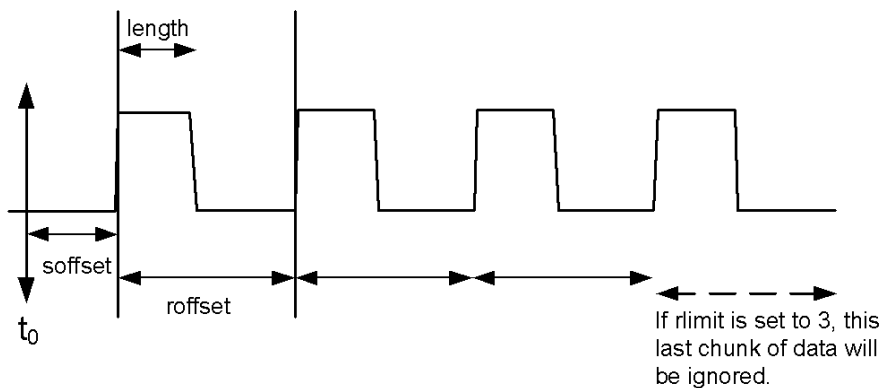

## Sample Trace Data - Not Constant Envelope

(See below for explanation of variables.)

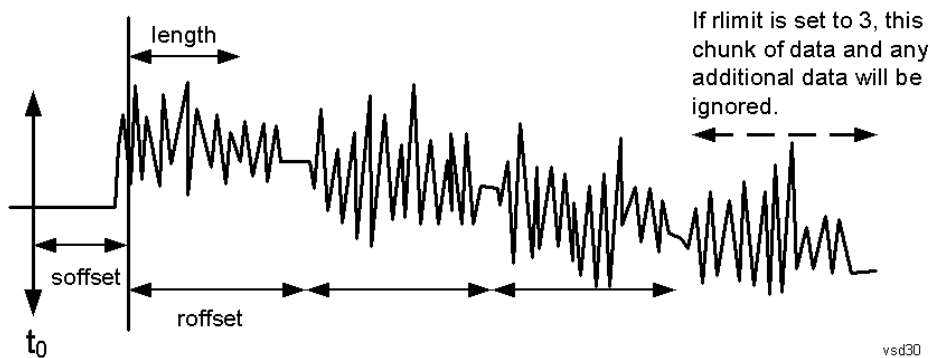

<soffset> - start offset is an optional real number. (It is in seconds for time-domain traces, and is a dimensionless index 0 to Npoints - 1, for frequency-domain traces). It specifies the amount of data at the beginning of the trace that will be ignored before the decimation process starts. It is the time or frequency change from the start of the trace to the point where you want to start using the data. The default value is zero.

<length> - is an optional real number. (It is in seconds for time-domain traces, and is a dimensionless index 0 to Npoints - 1, for frequency-domain traces). It defines how much data will be compressed into one value. This parameter has a default value equal to the current trace length.

<roffset> - repeat offset is an optional real number. (It is in seconds for time-domain traces, and is a dimensionless index 0 to Npoints - 1, for frequency-domain traces). It defines the beginning of the next field of trace elements to be compressed. This is relative to the beginning of the previous field. This parameter has a default value equal to the <length> variable. Note that this parameter is used for a completely different purpose when curve fitting (see CFIT above).

<rlimit> - repeat limit is an optional integer. It specifies the number of data items that you want returned. It will ignore any additional items beyond that number. You can use the Start offset and the Repeat limit to pick out exactly what part of the data you want to use. The default value is all the data.

## Calculate Peaks of Trace Data (Remote Command Only)

Returns a list of all the peaks for the currently selected measurement and sub-opcode [n]. The peaks must meet the requirements of the peak threshold and excursion values.

n = any valid sub-opcode for the current measurement. See the MEASure:<measurement> command description of your specific measurement for information on the data that can be returned.

The command can only be used with specific sub-opcodes with measurement results that are trace data. Both real and complex traces can be searched, but complex traces are converted to magnitude in dBm. In many measurements the sub-opcode n=0, is the raw trace data which cannot be searched for peaks. And Sub-opcode n=1, is often calculated results values which also cannot be searched for peaks.

This command uses the data setting specified by the FORMat:BORDER and FORMat:DATA commands and can return real or ASCII data. If the format is set to INT,32, it returns REAL,32 data.

The command has four types of parameters:

- Threshold (in dBm)
- Excursion (in dB)
- Sorting order (amplitude, frequency, time)
- Optional in some measurements: Display line use (all, > display line, < display line)

---

<b>Remote Command</b>	<p>For Swept SA measurement:</p> <pre>:CALCulate:DATA[1] 2 ... 6:PEAKs? &lt;threshold&gt;,&lt;excursion&gt;[,AMPLitude   FREQuency   TIME[,ALL   GTDLine   LTDLine]]</pre> <p>For most other measurements:</p> <pre>:CALCulate:DATA[1] 2 ... 6:PEAKs? &lt;threshold&gt;,&lt;excursion&gt;[,AMPLitude   FREQuency   TIME]</pre>
-----------------------	--------------------------------------------------------------------------------------------------------------------------------------------------------------------------------------------------------------------------------------------------------------------------------------------------------------------------------

---

<b>Example</b>	<p>Example for Swept SA measurement in Spectrum Analyzer Mode:</p> <p>CALC:DATA4:PEAK? -40, 10, FREQ, GTDL This will identify the peaks of trace 4 that are above -40 dBm, with excursions of at least 10 dB. The peaks are returned in order of increasing frequency, starting with the lowest frequency. Only the peaks that are above the display line are returned.</p> <p>Query Results 1:</p> <p>With FORMat:DATA REAL, 32 selected, it returns a list of floating-point numbers. The first value in the list is the number of peak points that are in the following list. A peak point consists of two values: a peak amplitude followed by its corresponding frequency (or time).</p> <p>If no peaks are found the peak list will consist of only the number of peaks, (0).</p>
----------------	-----------------------------------------------------------------------------------------------------------------------------------------------------------------------------------------------------------------------------------------------------------------------------------------------------------------------------------------------------------------------------------------------------------------------------------------------------------------------------------------------------------------------------------------------------------------------------------------------------------------------------------------------------------------------------------------------------------------------------------------------------------------------------------------

---

<b>Notes</b>	<p>&lt;n&gt; - is the trace that will be used</p> <p>&lt;threshold&gt; - is the level below which trace data peaks are ignored. Note that the threshold value is required and is always used as a peak criterion. To effectively disable the threshold criterion for this command, provide a substantially low threshold value such as -200 dBm. Also note that the threshold value used in this command is independent of and has no effect on the threshold value stored under the Peak Criteria menu.</p> <p>&lt;excursion&gt; - is the minimum amplitude variation (rise and fall) required for a signal to be identified as peak. Note that the excursion value is required and is always used as a peak criterion. To effectively disable the excursion criterion for this command, provide the minimum value of 0.0 dB. Also note that the excursion value used in this command is independent of and has no effect on the</p>
--------------	---------------------------------------------------------------------------------------------------------------------------------------------------------------------------------------------------------------------------------------------------------------------------------------------------------------------------------------------------------------------------------------------------------------------------------------------------------------------------------------------------------------------------------------------------------------------------------------------------------------------------------------------------------------------------------------------------------------------------------------------------------------------------------------------------------------------------------------------------------------------------------------------------------------------------------------

---

---

excursion value stored under the Peak Criteria menu.

Values must be provided for threshold and excursion. The sorting and display line parameters are optional (defaults are AMPLitude and ALL).

Note that there is always a Y-axis value for the display line, regardless of whether the display line state is on or off. It is the current Y-axis value of the display line which is used by this command to determine whether a peak should be reported. Sorting order:

AMPLitude - lists the peaks in order of descending amplitude, with the highest peak first (default if optional parameter not sent)

FREQUENCY - lists the peaks in order of occurrence, left to right across the x-axis.

TIME - lists the peaks in order of occurrence, left to right across the x-axis.

Peaks vs. Display Line:

ALL - lists all of the peaks found (default if optional parameter not sent).

GTDLine (greater than display line) - lists all of the peaks found above the display line.

LTDLine (less than display line) - lists all of the peaks found below the display line.

---

Initial S/W Revision	Prior to A.02.00
----------------------	------------------

---

### Hardware-Accelerated Fast Power Measurement (Remote Command Only)

The Fast Power option (FP2) enables very fast channel power measurements for instruments with the prerequisite hardware (DP2 and/or B40). It accomplishes this by performing real-time overlapped FFTs at the hardware layer, using software for basic post-processing before returning the result to the user. The upshot of this approach is improved throughput for user applications that require many sequential power measurements.

The analysis bandwidth of FP2 is limited by the licenses in the instrument, but its maximum overall analysis bandwidth per acquisition is 40 MHz.

FP2 is remote-only, which means the instrument does not switch to any particular mode or measurement. FP2 commands can be sent while another application is in use on the front panel.

Each Fast Power measurement can be predefined using an array index, and up to 1,000 measurements can be stored. In the following documentation, instances of [1,2,...,999] can be substituted with a particular measurement index, e.g. CALC:FPOW:POW1?, CALC:FPOW:POW2?, CALC:FPOW:POW134?. In this way, power measurements can be defined one time in a batch, and then executed multiple times without having to redefine them, similar to “list mode” on other measurements.

In addition to basic channel power measurements, there are a number of other measurement “functions” for each channel, including peak power, peak frequency, and power spectral density. See the Function parameter for more information.

### Reset Fast Power Measurement (Remote Command Only)

Resets the measurement configuration to the defaults.

---

Mode	All
Remote Command	:CALCulate:FPOWer:POWer[1,2,...,999]:RESet
Example	:CALC:FPOW:POW1:RES

---

Notes	Option FP2 is required.
Initial S/W Revision	A.14.00

### Define Fast Power Measurement (Remote Command Only)

Fast Power acquisitions are configured using the DEFine command. This command accepts a comma-delimited string of configuration parameters and their appropriate values, which are all specified in the subsection below.

Mode	All
<b>Remote Command</b>	:CALCulate:FPOWER:POWer[1,2,...,999]:DEFine "configuration string"
<b>Example</b>	:CALC:FPOW:POW1:DEF "CenterFrequency=2e9, AcquisitionTime=0.005"
Notes	See below for a list of measurement variables that can be defined in the configuration string.
Initial S/W Revision	A.14.00

### Acquisition Time

Example	CALC:FPOW:POW1:DEF "AcquisitionTime=0.002"
Notes	The acquisition time parameter sets the time in which the entire spectrum is measured. An increase in the acquisition time yields an improvement in measurement repeatability.
Preset	0.001 s
Range	0 s to 1 s
Default Unit	Time (s)
Initial S/W Revision	A.14.00

### Center Frequency

Example	CALC:FPOW:POW1:DEF "CenterFrequency=2e9"
Notes	The center frequency parameter sets the frequency in which the measurement is centered around. The OffsetFrequency parameter is calculated relative to the center frequency.
Preset	1 GHz
Range	0 Hz to maximum instrument frequency
Default Unit	Frequency (Hz)
Initial S/W Revision	A.14.00

## DC Coupled

Example	CALC:FPOW:POW1:DEF "DCCoupled=True"
Notes	The DC coupled parameter allows the user to specify whether the DC blocking capacitor is utilized. Set parameter to true when measuring frequencies below 10 MHz.
Preset	False
Range	True (DC Coupled) or False (AC Coupled)
Default Unit	Boolean
Initial S/W Revision	A.14.00

## DetectorType

Example	CALC:FPOW:POW1:DEF "DetectorType=Peak"
Notes	Option FP2 is required. The detector type parameter allows the user to choose whether a RMS average or peak value is used during the measurement.
Preset	RmsAverage
Range	RmsAverage, Peak
Initial S/W Revision	A.14.00

## Do Noise Correction

Example	CALC:FPOW:POW1:DEF "DoNoiseCorrection=True"
Notes	When noise correction is enabled, the linear noise power contributed by the analyzer is subtracted from all measurements. This effectively lowers the noise floor of the analyzer. When noise correction is enabled, the first measurement for a given set of input parameters will take extra time. This is because the analyzer takes an extra acquisition with the RF input disconnected from the analyzer's front end to measure the noise of just the analyzer. The measured noise floor is stored in a cache so the noise acquisition will occur only once for the same state settings. In other words, if noise correction was turned on and the analyzer made an acquisition at frequency A, then frequency B, and back again to frequency A, the hidden initial noise floor acquisition would only occur for the first acquisition at frequency A and the cached noise floor would be used the second time frequency A was measured.
Preset	False
Range	True (enable noise correction) or False (disable noise correction)
Default Unit	Boolean
Initial S/W Revision	A.14.00

### Do Spur Suppression

Example	CALC:FPOW:POW1:DEF "DoSpurSuppression=True"
Notes	<p>When measuring very low level signals, or when large out-of-band inputs are input into the analyzer, sometimes unwanted spurs and residuals can appear in the measured spectrum. Spur suppression is a method to help minimize the levels of these internally generated spurs and residuals.</p> <p>When spur suppression is enabled, the analyzer will automatically take two acquisitions using two different internal analog LO frequencies. The FFT spectrums from both acquisitions are combined by taking the minimum power between both traces on a per FFT bin basis. External signals will have the same amplitude for both traces and therefore will return the expected amplitudes. However, low level spurs and residuals generated internally to the analyzer tend to move to different FFT bins depending on the internal analog LO frequency used, and therefore tend to be suppressed using this spur suppression method.</p> <p>Because two acquisitions, rather than a single acquisition, are made when spur suppression is enabled, the measurement time will always be slower when spur suppression is enabled.</p>
Preset	False
Range	True (enable spur suppression) or False (disable spur suppression)
Default Unit	Boolean
Initial S/W Revision	A.14.00

### Electronic Attenuator Bypass

Example	CALC:FPOW:POW1:DEF "ElecAttBypass =False"
Notes	The electronic attenuation bypass parameter allows the user to either utilize or bypass the electronic attenuator. The electronic attenuator is only available for frequencies up to 3.6 GHz. Set parameter to true when using frequencies above 3.6 GHz and set the parameter to false when using the preamp.
Preset	True
Range	True (bypass electronic attenuator) or False (use electronic attenuator)
Default Unit	Boolean
Initial S/W Revision	A.14.00

### Electronic Attenuation

Example	CALC:FPOW:POW1:DEF "ElecAttenuation=10"
Notes	<p>Option EA3 is required.</p> <p>The electronic attenuation value parameter sets the amount of electrical attenuation from 0 to 24 dB (1 dB steps).</p> <p>Set "ElecAttBypass=False" to make sure the electronic attenuator path is enabled.</p>
Preset	0 dB
Range	0 – 24 dB (1 dB steps)



Default Unit	dB
Initial S/W Revision	A.14.00

#### IF Gain

Example	CALC:FPOW:POW1:DEF "IFGain=10"
Notes	The IF gain parameter allows the user to specify the gain at the IF stage anywhere from -6 to 16 dB (1 dB steps). This is an advanced feature, and for most cases this should remain at its default value of 0 dB.
Preset	0 dB
Range	-6 - 16 dB (1 dB steps)
Default Unit	dB
Initial S/W Revision	A.14.00

#### IF Type

Example	CALC:FPOW:POW1:DEF "IFType=B25M"
Notes	The IF type parameter allows the user to select between different IF paths. For example, if the signal is less than 25 MHz wide, then the user can select the B25M path to take advantage of additional filtering on this analog IF path.
Preset	B40M
Range	B10M, B25M, B40M
Initial S/W Revision	A.14.00

#### Include Power Spectrum

Example	CALC:FPOW:POW1:DEF "IncludePowerSpectrum=True"
Notes	The power spectrum parameter allows the user to read data on the entire spectrum for diagnostic purposes. It is not recommended for production use. See CALC:FPOW:POW[n]:READ2? for details on the binary format of the response.
Preset	False
Range	True (return both channel power and full power spectrum) or False (returns only channel power)
Default Unit	Boolean
Initial S/W Revision	A.14.00

### Mechanical Attenuation

Example	CALC:FPOW:POW1:DEF "MechAttenuation=10"
Notes	The mechanical attenuation value parameter sets the amount of mechanical attenuation anywhere from 0 to 70 dB (2 dB steps).
Preset	0 dB
Range	0 – 70 dB (2 dB steps)
Default Unit	dB
Initial S/W Revision	A.14.00

### Preamp Mode

Example	CALC:FPOW:POW1:DEF "PreAmpMode=Low"
Notes	The license for the appropriate preamp is required. The preamp mode parameter specifies whether the preamps are being utilized. Low allows any preamps up to 3.6 GHz, and Full allows all licensed preamps. Set "ElecAttBypass=True" in order to utilize any preamps.
Preset	Off
Range	Off, Low, Full
Initial S/W Revision	A.14.00

### Resolution Bandwidth Mode

Example	CALC:FPOW:POW1:DEF "PreAmpMode=Low"
Notes	The resolution bandwidth mode parameter allows the user to choose whether the RBW filter is automatically or manually set. The BestSpeed value minimizes measurement time, while the Narrowest value minimizes RBW size (minimum of two FFT bins per RBW). To manually specify an RBW, set this parameter to Explicit, and set the ResolutionBW parameter to the desired value.
Preset	BestSpeed
Range	BestSpeed, Narrowest, Explicit
Initial S/W Revision	A.14.00

### Resolution Bandwidth

Example	CALC:FPOW:POW1:DEF "ResolutionBW=25e3"
Notes	The resolution bandwidth parameter sets the 3-dB bandwidth of the RBW filter. The ResolutionBWMode parameter must be set to Explicit in order to manually set the RBW.

Preset	0 Hz
Default Unit	Hz
Initial S/W Revision	A.14.00

#### Trigger Delay

Example	CALC:FPOW:POW1:DEF "TriggerDelay=0.025"
Notes	The trigger delay parameter sets the time after an external trigger is detected until the measurement is performed.
Preset	0 s
Range	0 – 1 s
Default Unit	Seconds
Initial S/W Revision	A.14.00

#### Trigger Level

Example	CALC:FPOW:POW1:DEF "TriggerLevel=2"
Notes	The trigger level parameter sets the voltage value at which an external trigger is detected.
Preset	1.2 V
Range	-5 to 5 V
Default Unit	Volts
Initial S/W Revision	A.14.00

#### Trigger Slope

Example	CALC:FPOW:POW1:DEF "TriggerSlope=Negative"
Notes	The trigger slope parameter indicates the direction of the edge trigger voltage for detection.
Preset	Positive
Range	Positive, Negative
Initial S/W Revision	A.14.00

### Trigger Source

Example	CALC:FPOW:POW1:DEF "TriggerSource=Ext1"
Notes	The trigger source parameter allows the user to choose between measurement's triggering freely or controlled by an external input. Ext1 and Ext2 correspond to Trigger 1 In and Trigger 2 In, respectively.
Preset	Free
Range	Free, Ext1, Ext2
Initial S/W Revision	A.14.00

### Trigger Timeout

Example	CALC:FPOW:POW1:DEF "TriggerTimeout=0.1"
Notes	The trigger timeout parameter sets the time in which the analyzer will wait for a trigger before automatically performing the measurement.
Preset	1 s
Range	0 - 1 s
Default Unit	Seconds
Initial S/W Revision	A.14.00

### Signal Input

Example	CALC:FPOW:POW1:DEF "SignalInput=Fp50MHzCW"
Notes	The signal input parameter allows the user to select between using the main RF input or the internal analyzer reference CW signal of 50 MHz.
Preset	FpMainRf
Range	FpMainRf, Fp50MHzCW
Initial S/W Revision	A.14.00

### Use Preselector

Example	CALC:FPOW:POW1:DEF "UsePreSelector=True"
Notes	The preselector parameter allows the user to either utilize or bypass the front end tunable filter at frequencies above 3.6 GHz. For frequencies below 3.6 GHz, the preselector is automatically bypassed, so you do not need to set this parameter to False in those cases.
Preset	False
Range	True (use preselector above 3.6 GHz), or False (preselector bypassed)

Default Unit	Boolean
Initial S/W Revision	A.14.00

### Channel Bandwidth Array

Example	CALC:FPOW:POW1:DEF "Bandwidth=[3.84e6, 5e6, 3.84e6]"
Notes	The bandwidth parameter array defines the bandwidth of each channel that will be measured. All array parameters should have the same number of elements. Alternatively, if all the elements are the same value, a single number with no square brackets can be used to define the parameter.
Preset	[1 e6]
Range	0 to 40 MHz
Default Unit	Hz
Initial S/W Revision	A.14.00

### Channel Filter Type Array

Example	CALC:FPOW:POW1:DEF "FilterType=[RRC, IBW, RRC]"
Notes	The filter type parameter allows the user to choose between an integration bandwidth (IBW) filter or a root-raised-cosine (RRC) filter. The integration bandwidth filter weighs all frequencies within the bandwidth equally. The root-raised-cosine filter has an associated shape parameter, defined by the FilterAlpha parameter. All array parameters should have the same number of elements. Alternatively, if all the elements are the same value, a single value with no square brackets can be used to define the parameter.
Preset	[IBW]
Range	IBW, RRC
Initial S/W Revision	A.14.00

### Channel Filter Alpha Array

Example	CALC:FPOW:POW1:DEF "FilterAlpha=[0.5, 0.0, 0.5]"
Notes	The filter alpha parameter allows the user to adjust the alpha value associated with the root-raised-cosine (RRC) filter type. Set FilterType to RRC in order to utilize this parameter. All array parameters should have the same number of elements. Alternatively, if all the elements are the same value, a single number with no square brackets can be used to define the parameter.
Preset	[0.22]
Range	0.0 – 1.0

Initial S/W Revision	A.14.00
-------------------------	---------

#### Channel Measurement Function Array

Example	CALC:FPOW:POW1:DEF "Function=[BandPower, PeakPower, BandPower]"
Notes	<p>This parameter array defines what measurement is being made for each individually-specified channel:</p> <p>BandPower: Total power within the specified bandwidth of the channel (dBm)</p> <p>BandDensity: Total power density within the specified bandwidth of the channel (dBm/Hz)</p> <p>PeakPower: The peak power value within the specified bandwidth of the channel (dBm)</p> <p>PeakFrequency: The frequency which corresponds to the peak power value within the specified bandwidth of the channel. This frequency is relative to the center frequency (Hz)</p> <p>XdBBandwidth: The half power (-3.01 dB) bandwidth of the highest amplitude signal that resides within the channel (Hz), dB is configurable using XdBBandwidth parameter</p> <p>OccupiedBandwidth: The bandwidth at which 99% of the total power resides within the channel (Hz), percentage configurable using OccupiedBandwidthPercent parameter</p> <p>All array parameters should have the same number of elements. Alternatively, if all the elements are the same value, a single value with no square brackets can be used to define the parameter.</p>
Preset	[BandPower]
Range	BandPower, BandDensity, PeakPower, PeakFrequency, XdBBandwidth, OccupiedBandwidth
Initial S/W Revision	A.14.00

#### Channel Offset Frequency Array

Example	CALC:FPOW:POW1:DEF "OffsetFrequency=[-5e6, 0, 5e6]"
Notes	<p>The offset frequency parameter array defines the difference between the center frequency to the center frequency of each channel.</p> <p>All array parameters should have the same number of elements.</p>
Preset	[0]
Range	0 to 20 MHz
Default Unit	Hz
Initial S/W Revision	A.14.00

#### Channel Occupied Bandwidth Percent Array

Example	CALC:FPOW:POW1:DEF "OccupiedBandwidthPercent =[0.95, 0.95, 0.95]"
Notes	This parameter only applies for channels whose Function is set to OccupiedBandwidth. The occupied

bandwidth percent parameter specifies the percent of total power in these channels. The valid range for this parameter is 0.0 to 1.0, where 1.0 represents 100%. The default for this parameter is 0.99, which will return the bandwidth that contains 99% of the total channel power.

Preset	[0.99]
Range	0 – 1.0
Initial S/W Revision	A.14.00

#### Channel x-dB Bandwidth Array

Example	CALC:FPOW:POW1:DEF " XdBBandwidth =[-6.02, -3.01, -1.0]"
Notes	This parameter only applies for channels whose Function is set to XdBBandwidth. The X dB bandwidth parameter is used to specify the power relative to the peak channel power over which the bandwidth is calculated. The parameter value must be a negative number.
Preset	[-3.01]
Range	-200 to 0 dB
Default Unit	dB
Initial S/W Revision	A.14.00

#### Define Fast Power Measurement Query (Remote Command Only)

The DEFine? command is used to retrieve a list of all defined parameters in an ASCII string format

```

M All
o
d
e
R :CALCulate:FPOWER:POWer [1,2,...,999]:DEFine?
e
m
o
t
e
C
o
m
m
a
n
d
E :CALC:FPOW:POW1:DEF?

```

```
x
a
m
p
l
e
-----
N This command query is used to retrieve a list of all defined parameters in an ASCII format.
o The following is an example of the returned results:
t "DCCoupled=False,ElecAttBypass=True,ElecAttenuation=0,IFGain=0,MechAttenuation=0,PreAmpMode=Off,PreSelectorOffset
e =0,UsePreSelector=False,ExternalReferenceFrequency=10000000,FrequencyReferenceSource=AutoExternalFrequencyRefer
s ence,IFType=B40M,LOMode=SLW,SignalInput=FpMainRf,AcquisitionTime=0.001,CenterFrequency=1000000000,Resolution
BW=0,ResolutionBWMode=BestSpeed,DetectorType=RmsAverage,Bandwidth=[1000000],OffsetFrequency=[0],Function=
[BandPower],FilterType=[IBW],FilterAlpha=[0.22],OccupiedBandwidthPercent=[0.99],XdBBandwidth=[-
3.01],DoNoiseCorrection=False,DoSpurSuppression=False,MeasurementMethod=HardwareFFT,IncludePowerSpectrum=False,
e,TriggerDelay=0,TriggerLevel=1.2,TriggerSlope=Positive,TriggerSource=Free,TriggerTimeout=1 "
-----
I A.14.00
n
i
t
i
a
l

S
/
W

R
e
v
i
s
i
o
n
```

### Configure Fast Power Measurement (Remote Command Only)

The configure command begins hardware setup and returns immediately, with no acquisition made. This can be used in parallel with other hardware operations to effectively hide the hardware setup time.

Mode	All
<b>Remote Command</b>	:CALCulate:FPOWer:POWer[1,2,...,999]:CONFigure
<b>Example</b>	:CALC:FPOW:POW1:CONF
Notes	Option FP2 is required.
Initial S/W Revision	A.14.00



### Initiate Fast Power Measurement (Remote Command Only)

The INITiate command begins an acquisition and returns immediately. The results of the measurement can be retrieved using FETCh.

Mode	All
<b>Remote Command</b>	:CALCulate:FPOWer:POWer[1,2,...,999]:INITiate
<b>Example</b>	:CALC:FPOW:POW1:INIT
Notes	Option FP2 is required.
Initial S/W Revision	A.14.00

### Fetch Fast Power Measurement (Remote Command Only)

The FETCh command query is used to retrieve the results of an acquisition initiated by the INIT command. The returned results are in ASCII string format. The string begins and ends with quotation marks.

Mode	All
<b>Remote Command</b>	:CALCulate:FPOWer:POWer[1,2,...,999]:FETCh?
<b>Example</b>	:CALC:FPOW:POW1:FETC?
Notes	Option FP2 is required. Returns m comma-separated ASCII values, where m corresponds to the number of bandwidths defined. 1. Declared function return in the 1st specified channel 2. Declared function return in the 2nd specified channel ... m. Declared function return in the last specified channel The INIT and FETC? command sequence performs the same functionality of a single CALC:FPOW:POW[n]? query. Units of the returned values are dependent on the Function parameter for each channel.
Initial S/W Revision	A.14.00

### Execute Fast Power Measurement (Remote Command Only)

This command query is used as shorthand for an INIT command immediately followed by a FETC? command. The returned results are in ASCII string format. The string begins and ends with quotation marks.

Mode	All
<b>Remote Command</b>	:CALCulate:FPOWer:POWer[1,2,...,999]?
<b>Example</b>	:CALC:FPOW:POW1?

Notes	Option FP2 is required. See notes for Fast Power Fetch for return format.
Initial S/W Revision	A.14.00

### Binary Read Fast Power Measurement (Remote Command Only)

This command query is used as shorthand for an INIT command immediately followed by a FETC? command. The returned results are in a binary format.

Mode	All
<b>Remote Command</b>	:CALCulate:FPOWER:POWER[1,2,...,999]:READ? :CALCulate:FPOWER:POWER[1,2,...,999]:READ1?
<b>Example</b>	:CALC:FPOW:POW1:READ? :CALC:FPOW:POW1:READ1?
Notes	Option FP2 is required. Returns m 4 byte floating point binary values (Little-Endian), where m corresponds to the number of bandwidths defined.
Initial S/W Revision	A.14.00

### Diagnostic Binary Read Fast Power Measurement (Remote Command Only)

This command query is used as shorthand for an INIT command immediately followed by a FETC? command. The returned results are in a binary format. This command is used primarily for diagnostic purposes to test for ADC overloads and to visibly inspect the spectrum.

Mode	All
<b>Remote Command</b>	:CALCulate:FPOWER:POWER[1,2,...,999]:READ2?
<b>Example</b>	:CALC:FPOW:POW1:READ2?
Notes	Option FP2 is required. Note: Spectrum data is only returned if the IncludePowerSpectrum parameter is set to True. If IncludePowerSpectrum is False, the number of spectrum points will be zero (0). Units of the returned values are dependent on the Function parameter per channel (e.g. dBm for BandPower, Hz for PeakFrequency). Returns binary data (Little-Endian) that contains information on m amount of channels, along with ADC over range and full spectrum data. The following is the binary format of the response. Bandwidth Return Value 1. Number of channels specified, m [4 byte int] 2. Declared function result for the 1st specified channel [4 byte float]

- 
- 3. Declared function result for the 2nd specified channel [4 byte float]
  - ...
  - (m + 1). Declared function result for the last (mth) specified channel [4 byte float]
  - ADC Over Range
    - 1. ADC over-range occurred (1: true, 0: false) [2 byte short]
  - Spectrum Data
    - 1. Number of points in the spectrum data, k [4 byte int]
    - 2. Start frequency of spectrum data (Hz) [8 byte double]
    - 3. Step frequency of spectrum data (Hz) [8 byte double]
    - 4. FFT bin at 1st point (dBm) [4 byte float]
    - 5. FFT bin at 2nd point (dBm) [4 byte float]
    - ...
    - (k + 3). FFT bin at last (kth) point (dBm) [4 byte float]
- 

Initial S/W Revision	A.14.00
-------------------------	---------

---

### Format Data: Numeric Data (Remote Command Only)

This command specifies the format of the trace data input and output. It specifies the formats used for trace data during data transfer across any remote port. It affects only the data format for setting and querying trace data for the :TRACe[:DATA], TRACe[:DATA]?, :CALCulate:DATA[n]? and FETCh:SANalyzer [n]? commands and queries.

<b>Remote Command</b>	:FORMat[:TRACe][:DATA] ASCii INTEger,32 REAL,32  REAL,64 :FORMat[:TRACe][:DATA]?
<b>Notes</b>	<p>The query response is:</p> <p>ASCii: ASC,8 REAL,32: REAL,32 REAL,64: REAL,64 INTEger,32: INT,32</p> <p>When the numeric data format is REAL or ASCii, data is output in the current Y Axis unit. When the data format is INTEger, data is output in units of m dBm (.001 dBm).</p> <p>The INT,32 format returns binary 32-bit integer values in internal units (m dBm), in a definite length block.</p>
<b>Dependencies</b>	<p>Sending a data format spec with an invalid number (for example, INT,48) generates no error. The analyzer simply uses the default (8 for ASCii, 32 for INTEger, 32 for REAL).</p> <p>Sending data to the analyzer which does not conform to the current FORMat specified, results in an error. Sending ASCII data when a definite block is expected generates message -161 "Invalid Block Data" and sending a definite block when ASCII data is expected generates message -121 "Invalid Character in Number".</p>
<b>Preset</b>	ASCii
<b>Backwards Compatibility</b>	Note that the INT,32 format is only applicable to the command, TRACe:DATA. This preserves

Notes	backwards compatibility for the Swept SA measurement. For all other commands/queries which honor FORMat:DATA, if INT,32 is sent the analyzer will behave as though it were set to REAL,32.
Initial S/W Revision	Prior to A.02.00

The specs for each output type follow:

ASCIi - Amplitude values are in ASCII, in the current Y Axis Unit, one ASCII character per digit, values separated by commas, each value in the form:

SX.YYYYYEsZZ

Where:

S = sign (+ or -)

X = one digit to left of decimal point

Y = 5 digits to right of decimal point

E = E, exponent header

s = sign of exponent (+ or -)

ZZ = two digit exponent

REAL,32 - Binary 32-bit real values in the current Y Axis Unit, in a definite length block.

REAL,64 - Binary 64-bit real values in the current Y Axis Unit, in a definite length block.

### Format Data: Byte Order (Remote Command Only)

This command selects the binary data byte order for data transfer and other queries. It controls whether binary data is transferred in normal or swapped mode. This command affects only the byte order for setting and querying trace data for the :TRACe[:DATA], TRACe[:DATA]? , :CALCulate:DATA[n]? and FETCh:SANalyzer[n]? commands and queries.

By definition any command that says it uses FORMat:DATA uses any format supported by FORMat:DATA.

The NORMal order is a byte sequence that begins with the most significant byte (MSB) first, and ends with the least significant byte (LSB) last in the sequence: 1|2|3|4. SWAPped order is when the byte sequence begins with the LSB first, and ends with the MSB last in the sequence: 4|3|2|1.

<b>Remote Command</b>	:FORMat:BORDer NORMal   SWAPped :FORMat:BORDer?
Preset	NORMal
Initial S/W Revision	Prior to A.02.00

## Meas Setup

Displays the setup menu for the currently selected measurement. The parameters included in this menu are as follows.

Averaging

IF Gain

Channel Power Span

Integrated Bandwidth

Filter Bandwidth

Root Raised Cosine (RRC) Filter

Key Path	Front-panel key
Initial S/W Revision	Prior to A.02.00

## Avg/Hold Num

Specifies the number of measurement averages used to calculate the measurement result. The average is displayed at the end of each sweep. After the specified number of average counts, the averaging mode (terminal control) setting determines the averaging action.

Key Path	Meas Setup
Mode	SA, WCDMA, C2K, WIMAX OFDMA, 1xEVDO, DVB-T/H, DTMB (CTTB), ISDB-T, CMMB, LTE, LTETDD, Digital Cable TV, WLAN, MSR, LTEAFDD, LTEATDD
<b>Remote Command</b>	[:SENSe]:CHPower:AVERage:COUNT <integer> [:SENSe]:CHPower:AVERage:COUNT? [:SENSe]:CHPower:AVERage[:STATe] ON OFF 1 0 [:SENSe]:CHPower:AVERage[:STATe]?
<b>Example</b>	CHP:AVER:COUN 15 CHP:AVER:COUN? CHP:AVER ON CHP:AVER?
Notes	You must be in the Spectrum Analysis mode, W-CDMA mode, cdma2000 mode, DVB-T/H mode, DTMB (CTTB) mode, ISDB-T mode, CMMB mode, Digital Cable TV mode, LTE mode, LTE TDD mode 1xEVDO mode or WIMAX OFDMA mode to use this command. Use :INSTRument:SElect to set the mode.
Preset	SA: 10 WCDMA: 200 WIMAX OFDMA, LTE, LTETDD, MSR: 200 CDMA2K: 20 1xEVDO: 20

	DVB-T/H: 20 DTMB (CTTB): 20 ISDB-T: 10 CMMB: 10 Digital Cable TV: 10 WLAN: 10 LTEAFDD, LTEATDD:200 ON
State Saved	Saved in instrument state.
Min	1
Max	10000
Initial S/W Revision	Prior to A.02.00
Modified at S/W Revision	A.02.00, A.03.00

## Avg Mode

Allows you to select the type of termination control used for the averaging function. This determines the averaging action after the specified number of data acquisitions (average count) is reached.

When set to Exponential (Exp) the measurement averaging continues using the specified number of averages to compute each exponentially-weighted averaged value. The average is displayed at the end of each sweep.

When set to Repeat, the measurement resets the average counter each time the specified number of averages is reached.

Key Path	Meas Setup
Mode	SA, WCDMA, C2K, WIMAX OFDMA, 1xEVDO, DVB-T/H, DTMB (CTTB), ISDB-T, CMMB, LTE, LTEATDD, Digital Cable TV, WLAN, MSR, LTEAFDD, LTEATDD
Remote Command	[ :SENSe ] :CHPower:AVERage:TCONtrol EXPonential REPeat [ :SENSe ] :CHPower:AVERage:TCONtrol?
Example	CHP:AVER:TCON EXP CHP:AVER:TCON?
Notes	You must be in the Spectrum Analysis mode, W-CDMA mode, cdma2000 mode, DVB-T/H mode, DTMB (CTTB) mode, ISDB-T mode, CMMB mode, Digital Cable TV mode, LTE mode, LTE TDD mode, WLAN mode, 1xEVDO mode or WIMAX OFDMA mode to use this command. Use :INSTrument:SElect to set the mode.
Preset	EXP
State Saved	Saved in instrument state.
Range	Exp Repeat
Initial S/W Revision	Prior to A.02.00
Modified at S/W Revision	A.02.00, A.03.00

## Integ BW

Specifies the range of integration used in calculating the power in the channel. The integration bandwidth (IBW) is displayed on the trace as two markers connected by an arrow.

Key Path	Meas Setup
Mode	SA, WCDMA, C2K, WIMAX OFDMA, 1xEVDO, DVB-T/H, DTMB (CTTB), ISDB-T, CMMB, LTE, LTETDD, Digital Cable TV, WLAN, LTEAFDD, LTEATDD
Remote Command	<code>[ :SENSe ] :CHPower:BANDwidth:INTEgration &lt;bandwidth&gt;</code> <code>[ :SENSe ] :CHPower:BANDwidth:INTEgration?</code>
Example	CHP:BAND:INT 10MHz CHP:BAND:INT?
Notes	You must be in the Spectrum Analysis mode, W-CDMA mode, cdma2000 mode, DVB-T/H mode, DTMB (CTTB) mode, ISDB-T mode, CMMB mode, Digital Cable TV mode, LTE mode, LTE TDD mode, WLAN mode, 1xEVDO mode or WIMAX OFDMA mode to use this command. Use <code>:INSTrument:SElect</code> to set the mode.
Dependencies	For MSR/LTE-Advanced FDD/TDD mode, this key is blank. In order to keep backwards compatible with the legacy LTE FDD/TDD, the <code>scpi</code> command is supported in LTE & LTE-A converged application.
Couplings	The minimum value of the span is coupled with the integration bandwidth.
Preset	SA: 2 MHz WCDMA: 5 MHz C2K: 1.23 MHz WIMAX OFDMA: 10 MHz 1xEVDO: 1.23 MHz DVB-T/H: 7.61MHz DTMB (CTTB): 8MHz ISDB-T: 5.6MHz CMMB: 8MHz LTE: 5 MHz LTETDD: 5 MHz Digital Cable TV: 8MHz WLAN: if Radio Std is 802.11a/g(OFDM/DSSS-OFDM): 20 MHz if Radio Std is 802.11b: 25 MHz if Radio Std is 802.11n(20MHz): 20 MHz if Radio Std is 802.11n(40MHz): 40 MHz if Radio Std is 802.11ac (20 MHz): 20 MHz if Radio Std is 802.11ac (40 MHz): 40 MHz if Radio Std is 802.11ac (80 MHz): 80 MHz if Radio Std is 802.11ac (160 MHz): 160 MHz

	if Radio Std is 802.11ac (80 MHz + 80 MHz): 80 MHz
State Saved	Saved in instrument state.
Min	100 Hz
Max	Hardware Maximum Span
Initial S/W Revision	Prior to A.02.00
Modified at S/W Revision	A.02.00, A.03.00, A.14.50

## Method

Turns the Root Raised Cosine (RRC) filter On or Off. The  $\alpha$  value (roll off) for the filter is set to the value of the Filter Alpha parameter, and the RRC filter bandwidth is set to the Filter BW parameter.

Key Path	Meas Setup
Mode	SA, WCDMA,WIMAX OFDMA, DVB-T/H, DTMB (CTTB), ISDB-T, CMMB, LTE, LTETDD, Digital Cable TV, WLAN, LTEAFDD, LTEATDD
Remote Command	[ :SENSe ] :CHPower:FILTer [ :RRC ] [ :STATe ] OFF ON 0 1 [ :SENSe ] :CHPower:FILTer [ :RRC ] [ :STATe ] ?
Example	CHP:FILT OFF CHP:FILT?
Notes	This parameter is normally used when TETRA is selected as the Radio Std. You must be in the Spectrum Analysis mode, DVB-T/H mode, DTMB (CTTB) mode, ISDB-T mode, CMMB mode, LTE mode, LTE TDD mode, WLAN mode,WIMAX OFDMA mode or W-CDMA mode to use this command. Use :INSTrument:SElect to set the mode.
Dependencies	For CDMA2K mode, this key is blank. For 1xEVDO mode, this key is blank. For MSR mode, this key is blank. For LTE-Advanced FDD/TDD mode, this key is blank. In order to keep backwards compatible with the legacy LTE FDD/TDD, the scpi command is supported in LTE & LTE-A converged application For WLAN 802.11 ac (80 + 80 MHz ), RRC Weighted is not supported .
Preset	OFF
State Saved	Saved in instrument state.
Range	Integ BW RRC Weighted
Initial S/W Revision	Prior to A.02.00
Modified at S/W Revision	A.02.00, A.03.00, A.10.00



## Method

Turns the Root Raised Cosine (RRC) filter On or Off. The  $\alpha$  value (roll off) for the filter is set to the value of the Filter Alpha parameter, and the RRC filter bandwidth is set to the Filter BW parameter.

Key Path	Meas Setup
Mode	SA, WCDMA,WIMAX OFDMA, DVB-T/H, DTMB (CTTB), ISDB-T, CMMB, LTE, LTETDD, Digital Cable TV, WLAN, LTEAFDD, LTEATDD
Remote Command	[ :SENSe ] :CHPower:FILTer [:RRC] [:STATe] OFF ON 0 1 [ :SENSe ] :CHPower:FILTer [:RRC] [:STATe] ?
Example	CHP:FILT OFF CHP:FILT?
Notes	This parameter is normally used when TETRA is selected as the Radio Std. You must be in the Spectrum Analysis mode, DVB-T/H mode, DTMB (CTTB) mode, ISDB-T mode, CMMB mode, LTE mode, LTE TDD mode, WLAN mode,WIMAX OFMDA mode or W-CDMA mode to use this command. Use :INSTrument:SElect to set the mode.
Dependencies	For CDMA2K mode, this key is blank. For 1xEVDO mode, this key is blank. For MSR mode, this key is blank. For LTE-Advanced FDD/TDD mode, this key is blank. In order to keep backwards compatible with the legacy LTE FDD/TDD, the scpi command is supported in LTE & LTE-A converged application For WLAN 802.11 ac (80 + 80 MHz ), RRC Weighted is not supported .
Preset	OFF
State Saved	Saved in instrument state.
Range	Integ BW RRC Weighted
Initial S/W Revision	Prior to A.02.00
Modified at S/W Revision	A.02.00, A.03.00, A.10.00

## Filter Alpha

Inputs the alpha value for the Root Raised Cosine (RRC) filter.

Key Path	Meas Setup, Method
Mode	SA, WCDMA,WIMAX OFDMA, DVB-T/H, DTMB (CTTB), ISDB-T, CMMB, LTE, LTETDD, Digital Cable TV, WLAN, LTEAFDD, LTEATDD
Remote Command	[ :SENSe ] :CHPower:FILTer [:RRC] :ALPHa <real> [ :SENSe ] :CHPower:FILTer [:RRC] :ALPHa?
Example	CHP:FILT:ALPH 0.5 CHP:FILT:ALPH?
Notes	This parameter is normally used when TETRA is selected as the Radio Std. You must be in the Spectrum Analysis mode, DVB-T/H mode, DTMB (CTTB) mode, ISDB-T mode, CMMB mode, LTE

	mode, LTE TDD mode, WLAN mode, WIMAX OFDMA mode or W-CDMA mode to use this command. Use :INSTRument:SElect to set the mode.
Dependencies	For CDMA2K mode, this key is blank. For 1xEVDO mode, this key is blank. For MSR mode, this key is blank. For LTE-Advanced FDD/TDD mode, this key is blank In order to keep backwards compatible with the legacy LTE FDD/TDD, the scpi command is supported in LTE & LTE-A converged application
Preset	SA, WCDMA, , WIMAX OFDMA, DVB-T/H, ISDB-T, CMMB, LTE, LTETDD, WLAN: 0.22 DTMB (CTTB): 0.05 Digital Cable TV: 0.15
State Saved	Saved in instrument state.
Min	0.01
Max	1.00
Initial S/W Revision	Prior to A.02.00
Modified at S/W Revision	A.02.00, A.03.00, A.10.00

### Filter BW

Inputs the Root Raised Cosine (RRC) filter bandwidth. Normally, the filter bandwidth is the same as the symbol rate of the signal.

Key Path	Meas Setup, Method, RRC Weighted
Mode	SA, WCDMA, WIMAX OFDMA, DVB-T/H, DTMB (CTTB), ISDB-T, CMMB, LTE, LTETDD, Digital Cable TV, WLAN, LTEAFDD, LTEATDD
Remote Command	[ :SENSe ] :CHPower:FILTer [ :RRC ] :BANDwidth <real> [ :SENSe ] :CHPower:FILTer [ :RRC ] :BANDwidth?
Example	CHP:FILT:BAND 10MHz CHP:FILT:BAND?
Notes	This parameter is normally used when TETRA is selected as the Radio Std. You must be in the Spectrum Analysis mode, DVB-T/H mode, DTMB (CTTB) mode, ISDB-T mode, CMMB mode, LTE mode, LTE TDD mode, WLAN mode, WIMAX OFDMA mode or W-CDMA mode to use this command. Use :INSTRument:SElect to set the mode.
Dependencies	For CDMA2K mode, this key is blank. For 1xEVDO mode, this key is blank. For MSR mode, this key is blank. For LTE-Advanced FDD/TDD, this key is blank. In order to keep backwards compatible with the legacy LTE FDD/TDD, the scpi command is supported in LTE & LTE-A converged application
Preset	SA, LTE, LTETDD: 3.84MHz WCDMA: 3.84MHz

	WIMAX OFDMA: 10MHz DVB-T/H: 8MHz DTMB (CTTB): 7.56MHz ISDB-T: 5.6MHz CMMB: 7.512MHz Digital Cable TV: 6.9MHz WLAN: if Radio Std is 802.11a/g(OFDM/DSSS-OFDM): 16.6 MHz if Radio Std is 802.11b: 22 MHz if Radio Std is 802.11n(20MHz): 17.8 MHz if Radio Std is 802.11n(40MHz): 36.6 MHz
State Saved	Saved in instrument state.
Min	100 Hz
Max	100 MHz
<b>Backwards Compatibility SCPI</b>	[ :SENSe ] :CHPower :FILTer [ :RRC ] :BWIDth
Initial S/W Revision	Prior to A.02.00
Modified at S/W Revision	A.02.00, A.03.00, A.10.00

## Limits

Accesses the Limits menu that allows you to set up the test limit for channel power or power spectral density.

Key Path	Meas Setup
Initial S/W Revision	A.10.00

## Power Limit

If Power Limit is on, Power Limit is used as threshold which can judge whether the real measured channel power can be passed or not. If real measured channel power exceeds Power Limit, channel power test fails, otherwise, it passes. If Power Limit is off, channel power test is always passed.

Key Path	Meas Setup, Limits
Mode	SA, WCDMA, C2K, WIMAX OFDMA, 1xEVDO, LTE, LTETDD, Digital Cable TV, WLAN, LTEAFDD, LTEATDD
<b>Remote Command</b>	<pre> :CALCulate:CHPower:LIMit:POWer &lt;ampl&gt; :CALCulate:CHPower:LIMit:POWer? :CALCulate:CHPower:LIMit:POWer:STATe OFF ON 0 1 :CALCulate:CHPower:LIMit:POWer:STATe? </pre>

<b>Example</b>	CALC:CHP:LIM:POW 16.00 CALC:CHP:LIM:POW? CALC:CHP:LIM:POW:STAT ON CALC:CHP:LIM:POW:STAT?
<b>Notes</b>	This parameter and PSD Limit can determine Pass/Fail criteria. If (( power limit = On) and (PSD limit= Off) ) Pass if (power test passes) Fail if (power test fails) If (( power limit = On) and (PSD limit= On) ) Pass if ( both power test and PSD test pass) Fail if ( either of power test or PSD test fails) If (( power limit = Off) and (PSD limit= On) ) Pass if (PSD test passes) Fail if (PSD test fails) If (( power limit = Off) and (PSD limit= Off) ) Always Pass For MSR mode, this key is blank. For LTE-Advanced FDD/TDD mode, this key is blank. In order to keep backwards compatible with the legacy LTE FDD/TDD, the scpi command is supported in LTE & LTE-A converged application For WLAN 802.11 ac (80 MHz + 80 MHz), the power test and the PSD test are performed to both carriers. Which means the power (or PSD) readouts of both carriers should be compared with the power (or PSD) limit individually, and the test passes only when both values are lower than the limit.
<b>Preset</b>	16.00 SA, WCDMA, C2K, WIMAX OFDMA, 1xEVDO, DVB-T/H, DTMB (CTTB), LTE, LTETDD, Digital Cable TV: OFF WLAN: ON
<b>State Saved</b>	Saved in instrument state.
<b>Min</b>	-200.0
<b>Max</b>	200.0
<b>Initial S/W Revision</b>	A.10.00

## PSD Limit

If PSD (power spectral density) Limit is ON, PSD Limit is used as threshold which can judge whether the real measured PSD can be passed or not. If real measured PSD exceeds PSD Limit, PSD test fails, otherwise, it passes. If PSD is off, PSD test is always passed.

<b>Key Path</b>	Meas Setup, Limits
<b>Mode</b>	SA, WCDMA, C2K, WIMAX OFDMA, 1xEVDO, LTE, LTETDD, Digital Cable TV, WLAN
<b>Remote Command</b>	:CALCulate:CHPower:LIMit:PSDdensity <real>

	:CALCulate:CHPower:LIMit:PSDensity?
	:CALCulate:CHPower:LIMit:PSDensity:STATe OFF ON 0 1
	:CALCulate:CHPower:LIMit:PSDensity:STATe?
<b>Example</b>	CALC:CHP:LIM:PSD 4.00 CALC:CHP:LIM:PSD? CALC:CHP:LIM:POW:STAT ON CALC:CHP:LIM:POW:STAT?
<b>Notes</b>	This parameter and Power Limit can determine Pass/Fail criteria. If (( power limit = On) and (PSD limit= Off) ) Pass if (power test passes) Fail if (power test fails) If (( power limit = On) and (PSD limit= On) ) Pass if ( both power test and PSD test pass) Fail if ( either of power test or PSD test fails) If (( power limit = Off) and (PSD limit= On) ) Pass if (PSD test passes) Fail if (PSD test fails) If (( power limit = Off) and (PSD limit= Off) ) Always Pass For MSR mode, this key is blank. For LTE-Advanced FDD/TDD mode, this key is blank. For WLAN 802.11ac (80 MHz + 80 MHz), the power test and the PSD test are performed to both carriers. Which means the PSD (or power) readouts of both carriers should be compared with the PSD (or power) limit individually, and the test passes only when both values are lower than the limit.
<b>Couplings</b>	The value is automatically converted when PSD Unit is changed.
<b>Preset</b>	4.00 SA, WCDMA, C2K, WIMAX OFDMA, 1Xevdo, LTE, LTETDD, Digital Cable TV: OFF WLAN: ON
<b>State Saved</b>	Saved in instrument state.
<b>Min</b>	-200.0
<b>Max</b>	200.0
<b>Initial S/W Revision</b>	A.10.00

### Power Limit Fail (remote command only)

The command is query only and used to query if power test passes or fails.

<b>Remote Command</b>	:CALCulate:CHPower:LIMit:POWer:FAIL?
<b>Example</b>	CALC:CHP:LIM:POW:FAIL?

Notes	<p>This command is query only.</p> <p>When Power Limit is off, the returned value is always 0 (pass).</p> <p>When Power Limit is on, the returned value is 0(pass) while power test passes and 1(fail) while power test fails.</p> <p>In MSR, LTE-Advanced FDD/TDD mode, this feature is not supported.</p> <p>In order to keep backwards compatible with the legacy LTE FDD/TDD, the scpi command is supported in LTE &amp; LTE-A converged application.</p>
Initial S/W Revision	A.10.00

### PSD Limit Fail (remote command only)

The command is query only and used to query if PSD test passes or fails.

<b>Remote Command</b>	:CALCulate:CHPower:LIMit:PSD:FAIL?
<b>Example</b>	CALC:CHP:LIM:PSD:FAIL?
Notes	<p>This command is query only.</p> <p>When PSD Limit is off, the returned value is always 0 (pass).</p> <p>When PSD Limit is on, the returned value is 0(pass) while PSD test passes and 1(fail) while PSD test fails.</p>
Initial S/W Revision	A.10.00

### PSD Unit

Sets the unit bandwidth for Power Spectral Density. The available units are dBm/Hz and dBm/MHz.

Key Path	Meas Setup
Mode	SA, WCDMA, WIMAX OFDMA, 1xEVDO, DVB-T/H, DTMB (CTTB), LTE, LTETDD, Digital Cable TV, WLAN, MSR, LTEAFDD, LTEATDD
<b>Remote Command</b>	:UNIT:CHPower:POWer:PSD DBMHZ DBMMHZ :UNIT:CHPower:POWer:PSD?
<b>Example</b>	UNIT:CHP:POW:PSD DBMMHZ UNIT:CHP:POW:PSD?
Couplings	When the PSD unit is changed, the PSD result of the "MEAS READ FETCH:CHP1?" is also changed by the PSD unit basis (in either dBm/Hz or dBm/MHz).
Preset	DBMHZ WLAN: DBMMHZ
State Saved	Saved in instrument state.
Range	dBm/Hz dBm/MHz
Initial S/W Revision	Prior to A.02.00
Modified at S/W Revision	A.02.00, A.03.00

## Meas Preset

Restores all the measurement parameters to their default values.

Key Path	Meas Setup
Mode	SA, WCDMA, C2K, WIMAX OFDMA, 1xEVDO, DVB-T/H, DTMB (CTTB), ISDB-T, CMMB, LTE, LTETDD, Digital Cable TV, WLAN, MSR, LTEAFDD, LTEATDD
<b>Remote Command</b>	:CONFigure:CHPower
<b>Example</b>	CONF:CHP
Initial S/W Revision	Prior to A.02.00
Modified at S/W Revision	A.02.00, A.03.00

8 Channel Power Measurement  
Mode

Mode

See "[Mode](#)" on page 140



## Mode Preset

Returns the active mode to a known state.

Mode Preset does the following for the currently active mode:

- Aborts the currently running measurement.
- Brings up the default menu for the mode, with no active function.
- Sets measurement Global settings to their preset values for the active mode only.
- Activates the default measurement.
- Brings up the default menu for the mode.
- Clears the input and output buffers.
- Sets Status Byte to 0.

Mode Preset does not:

- Cause a mode switch
- Affect mode persistent settings
- Affect system settings
- See "[How-To Preset](#)" on page 350 for more information.

Key Path	Front-panel key
<b>Remote Command</b>	:SYSTem:PRESet
<b>Example</b>	:SYST:PRES
Notes	*RST is preferred over :SYST:PRES for remote operation. *RST does a Mode Preset, as done by the :SYST:PRES command, and it sets the measurement mode to Single measurement rather than Continuous for optimal remote control throughput. Clears all pending OPC bits. The Status Byte is set to 0.
Couplings	A Mode Preset aborts the currently running measurement, activates the default measurement, and gets the mode to a consistent state with all of the default couplings set.
Backwards Compatibility Notes	In the X-Series, the legacy "Factory Preset" has been replaced with Mode Preset, which only presets the currently active mode, not the entire instrument. In the X-Series, the way to preset the entire instrument is by using System, Restore System Defaults All, which behaves essentially the same way as restore System Defaults does on ESA and PSA. There is also no "Preset Type" as there is on the PSA. There is a green Mode Preset front-panel key that does a Mode Preset and a white-with-green-letters User Preset front-panel key that does a User Preset. The old PRESet:TYPE command is ignored (without generating an error), and SYST:PRES without a parameter does a Mode Preset, which should cover most backward code compatibility issues. The settings and correction data under the Input/Output front-panel key (examples: Input Z Corr, Ext Amp Gain, etc.) are no longer part of any Mode, so they will not be preset by a Mode Preset. They are preset using Restore Input/Output Defaults, Restore System Defaults All. Note that because User Preset does a Recall State, and all of these settings are saved in State, they ARE recalled when using

	User Preset.
Initial S/W Revision	Prior to A.02.00

## How-To Preset

The table below shows all possible presets, their corresponding SCPI commands and front-panel access (key paths). Instrument settings depend on the current measurement context. Some settings are local to the current measurement, some are global (common) across all the measurements in the current mode, and some are global to all the available modes. In a similar way, restoring the settings to their preset state can be done within the different contexts.

Auto Couple - is a measurement local key. It sets all Auto/Man parameter couplings in the measurement to Auto. Any Auto/Man selection that is local to other measurements in the mode will not be affected.

Meas Preset - is a measurement local key. Meas Preset resets all the variables local to the current measurement except the persistent ones.

Mode Preset - resets all the current mode's measurement local and measurement global variables except the persistent ones.

Restore Mode Defaults - resets ALL the Mode variables (and all the Meas global and Meas local variables), including the persistent ones.

Type Of Preset	SCPI Command	Front Panel Access
Auto Couple	:COUPle ALL	Auto Couple front-panel key
Meas Preset	:CONFigure:<Measurement>	Meas Setup Menu
Mode Preset	:SYSTem:PRESet	Mode Preset (green key)
Restore Mode Defaults	:INSTrument:DEFault	Mode Setup Menu
Restore All Mode Defaults	:SYSTem:DEFault MODes	System Menu; Restore System Default Menu
*RST	*RST	not possible (Mode Preset with Single)
Restore Input/Output Defaults	:SYSTem:DEFault INPUt	System Menu; Restore System Default Menu
Restore Power On Defaults	:SYSTem:DEFault PON	System Menu; Restore System Default Menu
Restore Alignment Defaults	:SYSTem:DEFault ALIGN	System Menu; Restore System Default Menu
Restore Miscellaneous Defaults	:SYSTem:DEFault MISC	System Menu; Restore System Default Menu
Restore All System Defaults	:SYSTem:DEFault [ALL] :SYSTem:PRESet:PERsistent	System Menu; Restore System Default Menu
User Preset	:SYSTem:PRESet:USER	User Preset Menu
User Preset All Modes	:SYSTem:PRESet:USER:ALL	User Preset Menu

Power On Mode Preset	:SYSTem:PON:TYPE MODE	System Menu
Power On User Preset	:SYSTem:PON:TYPE USER	System Menu
Power On Last State	:SYSTem:PON:TYPE LAST	System Menu

## Mode Setup

See "[Mode Setup](#)" on page 159

## Peak Search

Places the selected marker on the trace point with the maximum y-axis value. Pressing Peak Search with the selected marker Off causes the selected marker to be set to Normal, then a peak search is immediately performed.

<b>Key Path</b>	Front panel key
<b>Mode</b>	SA, WCDMA, C2K, WIMAX OFDMA, 1xEVDO, DVB-T/H, DTMB (CTTB), ISDB-T, CMMB, LTE, LTETDD, Digital Cable TV, WLAN, MSR, LTEAFDD, LTEATDD
<b>Remote Command</b>	:CALCulate:CHPower:MARKer[1] 2 ... 12:MAXimum
<b>Example</b>	CALC:CHP:MARK2:MAX
<b>Initial S/W Revision</b>	Prior to A.02.00
<b>Modified at S/W Revision</b>	A.02.00, A.03.00

8 Channel Power Measurement  
Print

Print

See "[Print](#) " on page 183

## Quick Save

The Quick Save front-panel key repeats the most recent save that was performed from the Save menu, with the following exceptions:

- Register saves are not remembered as Saves for the purpose of the Quick Save function
- If the current measurement does not support the last non-register save that was performed, an informational message is generated, “File type not supported for this measurement”

Quick Save repeats the last type of qualified save (that is, a save qualified by the above criteria) in the last save directory by creating a unique filename using the Auto File Naming algorithm described below.

If Quick Save is pressed after startup and before any qualified Save has been performed, the Quick Save function performs a Screen Image save using the current settings for Screen Image saves (current theme, current directory), which then becomes the “last save” for the purpose of subsequent Quick Saves.

The Auto File Naming feature automatically generates a file name for use when saving a file. The filename consists of a prefix and suffix separated by a dot, as is standard for the Windows® file system. A default prefix exists for each of the available file types:

Type	Default Prefix	Menu
State	State_	(Save/Recall)
Trace + State	State_	(Save/Recall)
Screen	Screen_	(Save/Recall)
Amplitude Corrections	Ampcor_	(Import/Export)
Traces	Trace_	(Import/Export)
Limit Lines	LLine_	(Import/Export)
Measurement Result	MeasR_	(Import/Export)
Capture Buffer	CapBuf_	(Import/Export)

A four digit number is appended to the prefix to create a unique file name. The numbering sequence starts at 0000 within each Mode for each file type and updates incrementally to 9999, then wraps to 0000 again. It remembers where it was through a Mode Preset and when leaving and returning to the Mode. It is reset by Restore Misc Defaults and Restore System Defaults and subsequent running of the instrument application. So, for example, the first auto file name generated for State files is State\_0000.state. The next is State\_0001, and so forth.

One of the key features of Auto File Name is that we guarantee that the Auto File Name will never conflict with an existing file. The algorithm looks for the next available number. If it gets to 9999, then it looks for holes. If it find no holes, that is no more numbers are available, it gives an error.

For example, if when we get to State\_0010.state there is already a State\_0010.state file in the current directory, it advances the counter to State\_0011.state to ensure that no conflict will exist (and then it verifies that State\_0011.state also does not exist in the current directory and advances again if it does, and so forth).

If you enter a file name for a given file type, then the prefix becomes the filename you entered instead of the default prefix, followed by an underscore. The last four letters (the suffix) are the 4-digit number.

For example, if you save a measurement results file as “fred.csv”, then the next auto file name chosen for a measurement results save will be fred\_0000.csv.

**NOTE**

Although 0000 is used in the example above, the number that is used is actually the current number in the Meas Results sequence, that is, the number that would have been used if you had not entered your own file name.

---

**NOTE**

If the filename you entered ends with \_dddd, where d=any number, making it look just like an auto file name, then the next auto file name picks up where you left off with the suffix being dddd + 1.

---

Key Path	Front-panel key
Notes	No remote command for this key specifically.
Initial S/W Revision	Prior to A.02.00



## Recall

The Recall menu lets you choose what you want to recall, and where you want to recall it from. Among the types of files you can recall are **States and Traces**. In addition, an Import (Data) option lets you recall a number of data types stored in CSV files (as used by Excel and other spreadsheet programs).

**NOTE**

In products that run multiple instances of the X-Series Application, all instances share the same register and file location where you want to recall from.

The default paths for Recall are data type dependent and are the same as for the Save key.

Key Path	Front-panel key
Notes	<p>No remote command for this key specifically, but the :MMEM:LOAD command is available for specific file types. An example is :MMEM:LOAD:STATE &lt;filename&gt;.</p> <p>If you try to recall a State file for a mode that is not licensed or not available in the instrument, an error message will occur and the state will not change.</p>
Backwards Compatibility Notes	<p>In legacy analyzers, it was possible to load a state without affecting the trace data, limit lines or correction data. Similarly (since User Preset is actually loading a state), it was possible to do a User Preset without affecting the trace data, limit lines or correction data.</p> <p>In the X-Series, “state” always includes all of this data; so whenever state is loaded, all of the traces, limit lines and corrections are affected. Although this differs from previous behavior, it is desirable behavior, and should not cause adverse issues for users.</p>
Backwards Compatibility Notes	<p>Recall for the X-Series supports backward compatibility in the sense that you can recall a state file from any X-Series model number and any version of X-Series software. This is only possible if part of the recalling process goes through a limiting step after recalling the mode settings, at least for settings that may vary with version number, model number, option and license differences. If you try to recall a state file onto an instrument with less capability than what was available on the instrument during the save, the recall will ignore the state it doesn't support and it will limit the recalled setting to what it allows.</p> <p>Example: if the saved state includes preamp ON, but the recalling instrument does not have a preamp; the preamp is limited to OFF. Conversely, if you save a state without a preamp, the preamp is OFF in the state file. When this saved file is recalled on an instrument with a licensed preamp, the preamp is changed to OFF. Another example is if the saved state has center frequency set to 20 GHz, but the instrument recalling the saved state is a different model and only supports 13.5 GHz. In this case, the center frequency is limited along with any other frequency based settings. Since the center frequency can't be preserved in this case, the recall limiting tries to at least preserve span to keep the measurement setup as intact as possible.</p> <p>It may be appropriate to issue a warning if the state is limited on the recall; warnings do not go out to SCPI so this would only affect the manual user.</p> <p>Note that there is no state file compatibility outside of the X-Series. For example, you cannot recall a state file from ESA or PSA.</p>
Initial S/W Revision	Prior to A.02.00

## State

The Recall State menu lets you choose a register or file from which to recall the state.

The content of a state file includes all of the settings and data required to return the analyzer as closely as possible to the Mode it was in, with the exact settings that were in place, when the save occurred. The Mode settings in each state file include the settings that are affected by Mode Preset, as well as the additional settings affected by Restore Mode Defaults; all of the Mode's settings. In addition, all of the settings of the Input/Output system are included, even though they are outside of the Mode's state, because they are needed to restore the complete setup. Persistent System settings (for example, GPIB address) are not affected by either a Mode Preset or Restore Mode Defaults, nor are they included in a saved State file.

Since each state file is only for one Mode, the settings for other Modes are unaffected when it is loaded. Recall State will cause a mode switch if the state being recalled is not from the current active mode.

After the recall completes, the message "File <filename> recalled" or "Recalled State Register <register number>" is displayed.

For rapid recalls, the State menu lists 16 registers that you can choose from to recall. Pressing a Register key initiates the recall. You can also select a file from which to recall.

The default path for all State Files is:

My Documents\<mode name>\state

where <mode name> is the parameter used to select the mode with the INST:SEL command (for example, SA for the Spectrum Analyzer).

See ["More Information" on page 359](#).

<b>Key Path</b>	Recall
<b>Mode</b>	All
<b>Remote Command</b>	:MMEMory:LOAD:STATe <filename>
<b>Example</b>	:MMEM:LOAD:STAT "myState.state" This recalls the file myState.state on the default path
<b>Example</b>	MMEM:LOAD:STAT "MyStateFile.state" This loads the state file data (on the default file directory path) into the instrument state.
<b>Notes</b>	<p>When you pick a file to recall, the analyzer first verifies that the file is recallable in the current instrument by checking the software version and model number of the instrument. If everything matches, a full recall proceeds by aborting the currently running measurement, clearing any pending operations, and then loading the State from the saved state file. You can open state files from any mode, so recalling a State file switches to the mode that was active when the save occurred. After switching to the mode of the saved state file, mode settings and data (if any for the mode) are loaded with values from the saved file. The saved measurement of the mode becomes the newly active measurement and the data relevant to the measurement (if there is any) is recalled.</p> <ul style="list-style-type: none"> <li>• If there is a mismatch between file version or model number or instrument version or model number, the recall function tries to recall as much as possible and returns a warning message. It may limit settings that differ based on model number, licensing or version number.</li> </ul> <p>After recalling the state, the Recall State function does the following:</p> <ul style="list-style-type: none"> <li>• Makes the saved measurement for the mode the active measurement.</li> <li>• Clears the input and output buffers.</li> <li>• Status Byte is set to 0.</li> </ul>

---

	<ul style="list-style-type: none"> <li>• Executes a *CLS</li> </ul> <p>If the file specified is empty an error is generated. If the specified file does not exist, another error is generated. If there is a mismatch between the file and the proper file type, an error is generated. If there is a mismatch between file version or model number or instrument version or model number, a warning is displayed. Then it returns to the State menu and File Open dialog goes away.</p> <p>After the Recall, the analyzer exits the Recall menu and returns to the previous menu.</p>
<b>Backwards Compatibility SCPI</b>	:MMEMory:LOAD:STATe 1,<filename>
Initial S/W Revision	Prior to A.02.00

---

### More Information

In measurements that support saving Traces, for example, Swept SA, the Trace data is saved along with the State in the State file. When recalling the State, the Trace data is recalled as well. Traces are recalled exactly as they were stored, including the writing mode and update and display modes. If a Trace was updating and visible when the State was saved, it will come back updating and visible, and its data will be rewritten right away. When you use State to save and recall traces, any trace whose data must be preserved should be placed in View or Blank mode before saving.

The following table describes the Trace Save and Recall possibilities:

---

You want to recall state and one trace's data, leaving other traces unaffected.	Save Trace+State from 1 trace. Make sure that no other traces are updating (they should all be in View or Blank mode) when the save is performed.	On Recall, specify the trace you want to load the one trace's data into. This trace will load in View. All other traces' data will be unaffected, although their trace mode will be as it was when the state save was performed.
You want to recall all traces	Save Trace+State from ALL traces.	On Recall, all traces will come back in View (or Blank if they were in Blank or Background when saved)
You want all traces to load exactly as they were when saved.	Save State	On recall, all traces' mode and data will be exactly as they were when saved. Any traces that were updating will have their data immediately overwritten.

---

### From File...

When you press "From File", the analyzer brings up a Windows dialog and a menu entitled "File Open." This menu allows you to navigate to the various fields in the Windows dialog without using a keyboard or mouse. The Tab and Arrow keys can also be used for dialog navigation.

## 8 Channel Power Measurement Recall

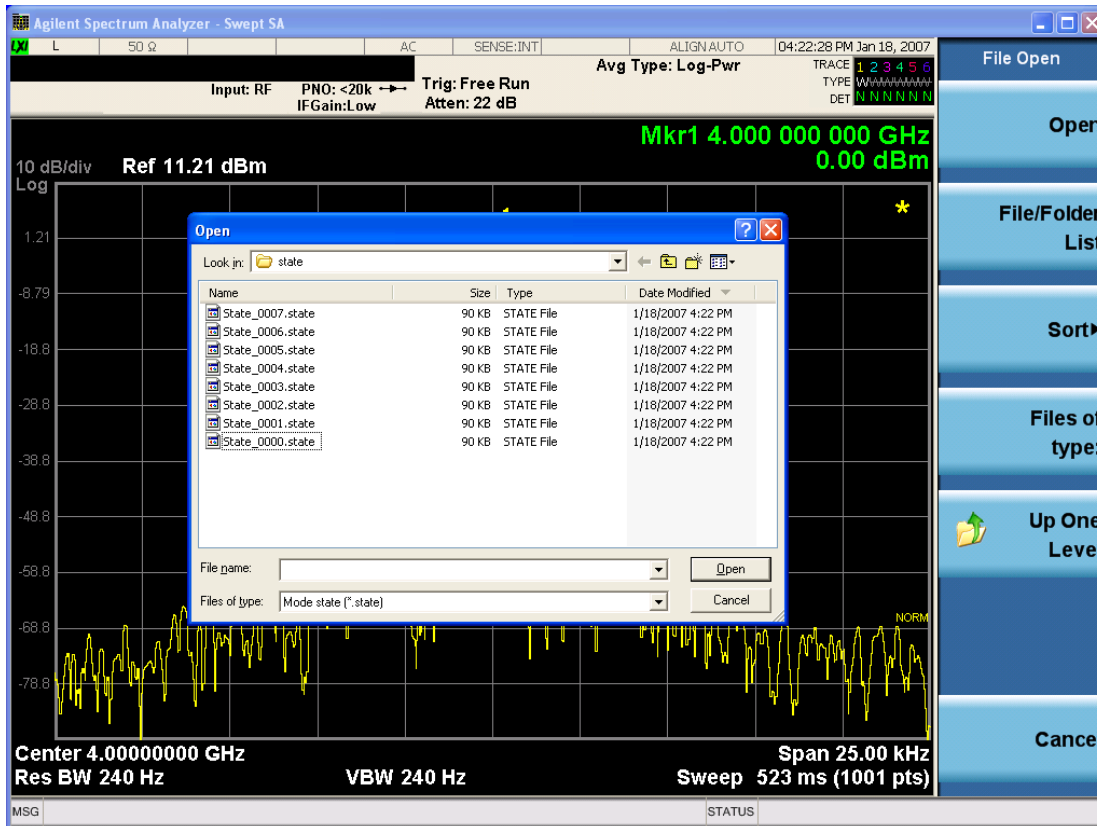

Listed below are the functions of the various fields in the dialog, and the corresponding softkeys:

### Open

Performs the recall of the specified file. While the recall is being performed, the floppy icon appears briefly in the Meas bar.

### File/Folder List

Enables you to navigate to the center of the dialog that contains the list of files and folders. Once here you can get information about the file and use the tab keys to navigate to the other fields in the dialog, such as Look In.

### Look In

The Look In field shows the path from which the file will be recalled and allows you to change the path using the up and down arrow keys to navigate to other paths; the Enter key to open a directory; and the Backspace key to go back one directory. The **Look In field** first uses the last path from the Save As dialog **Save In:** path for that same file type. There is no softkey for directly navigating to the Look In field, but you can use the left tab to get here from the File/Folder List.

User specified paths are remembered when you leave and return to a Mode and are reset back to the default using Restore Mode Defaults.

### Sort

Accesses a menu that enables you to sort the files within the File Open dialog. Only one sorting type can be selected at a time and the sorting happens immediately. The sorting types are By Date, By Name, By extension, and By Size.

#### Files of Type

This field shows the file suffix for the type of file you have selected to recall. For example, if you navigated here while recalling State, "Mode state (\*.state)" is in the field. If you navigated here while recalling Trace, ""Mode state (\*.trace)" is in the field. If you navigated here while importing a trace data file, "Trace Data (\*.csv)" is in the field. For some file types, there is more than one choice in the dropdown menu, which you can select by using the up and down arrow keys and Enter.

#### Up One Level

This key corresponds to the icon of a folder with the up arrow that is in the tool bar of the dialog. When pressed, it causes the file and folder list to navigate up one level in the directory structure. The Backspace key does the same thing.

#### Cancel

This key corresponds to the Cancel selection in the dialog. It causes the current **Open** request to be cancelled. The ESC key does the same thing.

Key Path	Recall, State
Notes	Brings up the Open dialog for recalling a State Save Type
Initial S/W Revision	Prior to A.02.00

## Edit Register Names

You may enter a custom name on any of the Register keys, to help you remember what you are using that state to save. To do this, press the Edit Register Names key, choose the register whose name you wish to edit, and then enter the desired label using the Alpha Editor or an external PC keyboard.

The maximum number of characters that can be added is 30. In most cases, 30 characters will fit on two lines of the key.

For more information and the SCPI command, see Edit Register Names under the Save, State function.

Key Path	Recall, State
Mode	All
Dependencies	N9060A-7FP or N9060B-2FP license required to edit the register names. When the feature is not licensed, sending the SCPI command generates an error, -221, "Settings conflict;Option not available"
Initial S/W Revision	A.11.00

## Register 1 thru Register 16

Selecting any one of these register keys causes the State of the mode from the specified Register to be recalled. Each of the register keys annotates whether it is empty or at what date and time it was last

modified. In addition, you can use the Edit Register Names key under Save, State to enter custom names for each register.

**NOTE**

In products that run multiple instances of the X-Series Application, recalling the same register name on each instance is a way to share setups between the instances.

Registers are shared by all modes, so recalling from any one of the registers will cause a mode switch to the mode that was active when the save to the Register occurred.

Although these 16 registers are the only registers available from the front panel, there are 128 state registers available in the instrument. Registers 17–128 are only available from the SCPI interface, using the \*RCL command.

After the recall completes, the message "Register <register number> recalled" appears in the message bar. If you are in the Spectrum Analyzer Mode, and you are recalling a register that was saved in the Spectrum Analyzer Mode, then after the recall, you will still be in the Recall Register menu. If the Recall causes you to switch modes, then after the Recall, you will be in the Frequency menu.

If a requested register is empty an error is generated.

Key Path	Recall, State
Example	*RCL 1
Range	1–16 from front panel, 1–128 from SCPI
Readback	Date and time with seconds resolution are displayed on the key OR A custom name of up to 30 characters entered using the Save, State, Edit Register Names key OR “(empty)” if no prior save operation has been performed to this register.
Initial S/W Revision	Prior to A.02.00
Modified at S/W Revision	Prior to A.11.00

## Register 1 thru Register 16

Selecting any one of these register keys causes the State of the mode from the specified Register to be recalled. Each of the register keys annotates whether it is empty or at what date and time it was last modified. In addition, you can use the Edit Register Names key under Save, State to enter custom names for each register.

**NOTE**

In products that run multiple instances of the X-Series Application, recalling the same register name on each instance is a way to share setups between the instances.

Registers are shared by all modes, so recalling from any one of the registers will cause a mode switch to the mode that was active when the save to the Register occurred.

Although these 16 registers are the only registers available from the front panel, there are 128 state registers available in the instrument. Registers 17–128 are only available from the SCPI interface, using the \*RCL command.

After the recall completes, the message "Register <register number> recalled" appears in the message bar. If you are in the Spectrum Analyzer Mode, and you are recalling a register that was saved in the Spectrum Analyzer Mode, then after the recall, you will still be in the Recall Register menu. If the Recall causes you to switch modes, then after the Recall, you will be in the Frequency menu.

If a requested register is empty an error is generated.

Key Path	Recall, State
<b>Example</b>	*RCL 1
Range	1-16 from front panel, 1-128 from SCPI
Readback	Date and time with seconds resolution are displayed on the key OR A custom name of up to 30 characters entered using the Save, State,Edit Register Names key OR “(empty)” if no prior save operation has been performed to this register.
Initial S/W Revision	Prior to A.02.00
Modified at S/W Revision	Prior to A.11.00

## Sequences

These keys allow you to import a Tab separated or .txt file that will automatically setup all the parameters required for building a Sequence. The parameters will automatically be loaded into the Stated Sequencer.

Once selected, in order to import the selected Sequence Type you must select the Open key in the Source Sequence menu.

Key Path	Recall, Sequences
Mode	All
<b>Remote Command</b>	:MMEMory:LOAD:SEQuences:   SLIS   ALIS   SAALIS   "MySequence.txt"
<b>Example</b>	:MMEM:LOAD:SEQ:SLIS "MySequence.txt"
Notes	Available file types are: –CSV (Comma delimited) (*.csv) –Text (Tab delimited) (*.txt)
Initial S/W Revision	A.05.00

## Source Sequence

The list of parameters, that configure steps, that makes up a sequence for the Source.

The Source sequence is a sequence of flexible configurable steps that can be set anywhere in the instruments frequency range.

Key Path	Recall,Sequences
----------	------------------

<b>Example</b>	:MMEM:LOAD:SEQ:SLIS "MySequence.txt"
<b>Dependencies</b>	Only available in XOBT
<b>Initial S/W Revision</b>	A.05.00

### Open...

When you press “Open”, the analyzer brings up a Windows dialog and a menu entitled “**File Open.**” This menu allows you to navigate to the various fields in the Windows dialog without using a keyboard or mouse. The Tab and Arrow keys can also be used for dialog navigation.

See "[From File...](#)" on page 1336 in Recall, State, for a full description of this dialog and menu.

<b>Key Path</b>	Recall, Data
<b>Notes</b>	The key location is mode-dependent and will vary. Brings up Open dialog for recalling a <mode specific> Save Type
<b>Initial S/W Revision</b>	Prior to A.02.00

### Data (Import)

Importing a data file loads data that was previously saved from the current measurement or from other measurements and/or modes that produce compatible data files. The Import Menu only contains Data Types that are supported by the current measurement.

Since the commonly exported data files are in .csv format, the data can be edited by the user prior to importing. This allows you to export a data file, manipulate the data in Excel (the most common PC Application for manipulating .csv files) and then import it.

Importing Data loads measurement data from the specified file into the specified or default destination, depending on the data type selected. Selecting an Import Data menu key will not actually cause the importing to occur, since the analyzer still needs to know from where to get the data. Pressing the Open key in this menu brings up the Open dialog and Open menu that provides you with the options from where to recall the data. Once a filename has been selected or entered in the Open menu, the recall occurs as soon as the Open button is pressed.

<b>Key Path</b>	Recall
<b>Mode</b>	All
<b>Notes</b>	The menu is built from whatever data types are available for the mode. Some keys will be missing completely, so the key locations in the sub-menu will vary. No SCPI command directly controls the Data Type that this key controls. The Data Type is included in the MMEM:LOAD commands.
<b>Dependencies</b>	If a file type is not used by a certain measurement, it is grayed out for that measurement. The key for a file type will not show at all if there are no measurements in the Mode that support it.
<b>Preset</b>	Is not affected by Preset or shutdown, but is reset during Restore Mode Defaults



Readback	The data type that is currently selected
Initial S/W Revision	Prior to A.02.00

## Mask

Enables you to recall a preset mask file. This file type (.mask) differs from a normal “state” file because it contains the configuration for Carrier, Offset, and Limit for the specific preset profile BW. A brief description of the mask file is available in the properties view of each file. (Right-mouse-click on the file, select, “Properties” to view this information.) A detailed list of the mask parameter values is located in the .pdf file of the same name in the same directory. Blank values in the .pdf file are parameters that will not be overwritten when recalling the mask.

Key Path	Recall, Data
Mode	WIMAXOFDMA
Remote Command	:MMEMory:LOAD:MASK <string>
Example	:MMEM:LOAD:MASK "MyLimitFile.mask"
Notes	Set of parameters related to Limit, Carrier and Offset are overwritten by Preset Mask file.
Initial S/W Revision	A.02.00

This topic contains the following sections:

["File location and extension" on page 365](#)

["Example of Preset Mask file" on page 366](#)

### File location and extension

**File location:** The preset mask file is located in “My Documents\WIMAXOFDMA\data\masks”.

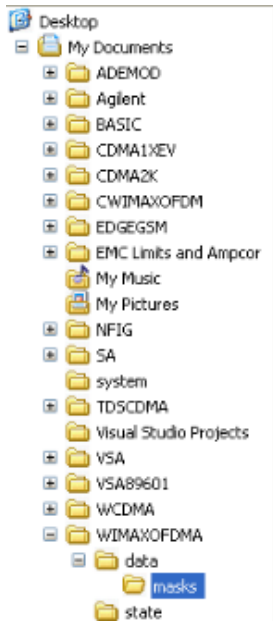

**NOTE**

When your X-Series analyzer starts, all mask files located in “My Documents\WIMAXOFDMA\data.masks” are overwritten, so any files you wish to save should be stored in another directory location.

**File type:** The file type is binary file.

**File Name:** The file name is decided by following naming rules. Each specific keyword is connected with underscore.

<Standard name>\_<Radio device>\_<Preset Profile BW>\_<Measurement>.mask

<Standard name>: This term references the standard associated with each mask file.

<Radio device>: This term specifies to which radio device (BS or MS) the mask file pertains.

<Preset Profile BW>: This term specifies to which Preset Profile BW the mask file pertains.

<Measurement>: This term specifies the measurement to which the mask file is applied. Your selections are: SEM, ACP, or Mode. When selecting **Mode**, the values of some parameters in both the ACP and SEM measurement are overwritten.

**File extension:** The extension of preset mask file is “mask” to distinguish it from a “state” file.

When you press the open key under the Data menu, the “My Documents\WIMAXOFDMA\data.masks” folder is opened. Select one mask file.

**NOTE**

When you change the preset BW profile or Radio Device, all measurement parameters are reset to their original values. Thus you have to recall the appropriate preset mask file again after the change.

### Example of Preset Mask file

When you import a preset mask file, it is a “Recall” function. Specific parameter values are overwritten by the contents of the preset mask file (see table below). Those values not specified by the preset mask file remain unchanged. Because the file format type is binary, you cannot view, change, or create the preset mask file. Here is an example of a preset mask file used for ACP measurements.

File Location: My Documents/WIMAXOFDMA/data/masks

File Name: ETSI-EN301-021-SysE\_BS\_10MHz\_ACP.mask

The .pdf file that lists the parameters similarly to that shown below is named, "ETSI-EN301-021-SysE\_BS\_10MHz\_ACP.pdf"

The set of parameters listed in the following table for the Preset Profile BW (10MHz) are imported into the ACP measurement.

Offset	Start Freq (MHz)	Stop Freq (MHz)	Sweep Time	Res BW (Hz)	Meas BW	Rel Start	Rel Stop	Fail Mask
A	5	7.14		30k	1	-8	-25	Rel
B	7.14	10.57		30k	1	-25	-27	Rel
C	10.57	20		30k	1	-27	-50	Rel
D	20	25		30k	1	-50	-50	Rel
E	25	30		30k	1	-50	-50	Rel

## Zone Map

Pressing this key selects Zone Map as the data type to be imported.

The WiMAX-OFDMA application can load the Singal Studio Setup file, and the OFDMA Map file is compatible with the 89601A Mobile WiMAX omf file.

Key Path	Recall, Data
<b>Remote Command</b>	:MMEMory:LOAD:ZMAP <string>
<b>Example</b>	MMEM:LOAD:ZMAP "ZMap_0000.omf"
Notes	The SCPI parameter is a quoted string that specifies the filename. Both single and double quotes are supported for any filename parameter over SCPI.
Dependencies	You must be in the 802.16 OFDMA (WiMAX/WiBro) mode.
Status Bits/OPC dependencies	Sequential - waits for the previous measurement to complete.
Initial S/W Revision	Prior to A.02.00

## Open...

When you press "Open", the analyzer brings up a Windows dialog and a menu entitled "File Open." This menu allows you to navigate to the various fields in the Windows dialog without using a keyboard or mouse. The Tab and Arrow keys can also be used for dialog navigation.

See "[From File...](#)" on page 1336 in Recall, State, for a full description of this dialog and menu.

8 Channel Power Measurement  
Recall

Key Path	Recall, Data
Notes	The key location is mode-dependent and will vary. Brings up Open dialog for recalling a <mode specific> Save Type
Initial S/W Revision	Prior to A.02.00

## Restart

The Restart function restarts the current sweep, or measurement, or set of averaged/held sweeps or measurements. If you are Paused, pressing Restart does a Resume.

The Restart function is accessed in several ways:

- Pressing the Restart key
- Sending the remote command INIT:IMMEDIATE
- Sending the remote command INIT:RESTART

See "[More Information](#)" on page 369

Key Path	Front-panel key
Remote Command	:INITiate[:IMMEDIATE] :INITiate:RESTART
Example	:INIT:IMM :INIT:REST
Notes	:INITiate:RESTART and :INITiate:IMMEDIATE perform exactly the same function.
Couplings	Resets average/hold count k. For the first sweep overwrites all active (update=on) traces with new current data. For application modes, it resets other parameters as required by the measurement.
Status Bits/OPC dependencies	This is an Overlapped command. The STATUS:OPERation register bits 0 through 8 are cleared. The STATUS:QUESTIONable register bit 9 (INTEgrity sum) is cleared. The SWEEPING bit is set. The MEASURING bit is set.
Backwards Compatibility Notes	For Spectrum Analysis mode in ESA and PSA, the Restart hardkey and the INITiate:RESTART command restart trace averages (displayed average count reset to 1) for a trace in Clear Write, but did not restart Max Hold and Min Hold. In the X-Series, the Restart hardkey and the INITiate:RESTART command restart not only Trace Average, but MaxHold and MinHold traces as well. For wireless comms modes in ESA and PSA, the Restart hardkey and the INITiate:RESTART command restart every measurement, which includes all traces and numeric results. There is no change to this operation.
Initial S/W Revision	Prior to A.02.00

### More Information

The **Restart** function first aborts the current sweep/measurement as quickly as possible. It then resets the sweep and trigger systems, sets up the measurement and initiates a new data measurement sequence with a new data acquisition (sweep) taken once the trigger condition is met.

If the analyzer is in the process of aligning when **Restart** is executed, the alignment finishes before the restart function is performed.

Even when set for Single operation, multiple sweeps may be taken when Restart is pressed (for example, when averaging/holding is on). Thus when we say that **Restart** "restarts a measurement," we may mean:

- It restarts the current sweep
- It restarts the current measurement
- It restarts the current set of sweeps if any trace is in Trace Average, Max Hold or Min Hold
- It restarts the current set of measurements if Averaging, or Max Hold, or Min Hold is on for the measurement
- depending on the current settings.

With **Average/Hold Number** (in **Meas Setup** menu) set to 1, or Averaging off, or no trace in Trace Average or Hold, a single sweep is equivalent to a single measurement. A single sweep is taken after the trigger condition is met; and the analyzer stops sweeping once that sweep has completed. However, with **Average/Hold Number** >1 and at least one trace set to **Trace Average**, **Max Hold**, or **Min Hold (SA Measurement)** or **Averaging on (most other measurements)**, multiple sweeps/data acquisitions are taken for a single measurement. The trigger condition must be met prior to each sweep. The sweep is stopped when the average count  $k$  equals the number  $N$  set for **Average/Hold Number**. A measurement average usually applies to all traces, marker results, and numeric results; but sometimes it only applies to the numeric results.

Once the full set of sweeps has been taken, the analyzer will go to idle state. To take one more sweep without resetting the average count, increment the average count by 1, by pressing the step up key while **Average/Hold Number** is the active function, or sending the remote command CALC:AVER:TCON UP.

## Save

The Save menu lets you choose what you want to save and where you want to save it. Among the types of files you can save are **States**, **Traces**, and **Screen Images**. In addition, an Export (Data) option lets you save a number of data types as CSV files for easy import into Excel and other spreadsheet programs.

Key Path	Front-panel key
Mode	All
Notes	No remote command for this key specifically, but the :MMEM:STORe command is available for specific file types. An example is :MMEM:STOR:STATe <filename>.
Initial S/W Revision	Prior to A.02.00

## State

The Save State menu lets you choose a register or file for saving the state.

### NOTE

In products that run multiple instances of the X-Series Application, all instances share the same register and file location where you want to save the state.

The content of a state file includes all of the settings and data required to return the analyzer as closely as possible to the Mode it was in, with the exact settings which were in place, when the save occurred. The Mode settings in each state file include the settings that are affected by Mode Preset, as well as the additional settings affected by Restore Mode Defaults; all of the Mode's settings. In addition, all of the settings of the Input/Output system are included, even though they are outside of the Mode's state, because they are needed to restore the complete setup. Persistent System settings (for example, Verbose SCPI) are not affected by either Mode Preset or Restore Mode Defaults, nor are they included in a saved State file.

After the save completes, the message "File <filename> saved" or "State Register <register number> saved" is displayed.

For rapid saving, the State menu lists 16 registers to save to. Pressing a Register key initiates the save. You can also select a file to save to.

The default path for all State Files is:

My Documents\<<mode name>\state

where <mode name> is the parameter used to select the mode with the INST:SEL command (for example, SA for the Spectrum Analyzer).

Key Path	Save
Mode	All
<b>Remote Command</b>	:MMEMory:STORe:STATe <filename>
<b>Example</b>	MMEM:STOR:STATe "MyStateFile.state" This stores the current instrument state data in the file MyStateFile.state in the default directory.
Notes	Both single and double quotes are supported for any filename parameter over remote.

After saving to a register, that register's menu key is updated with the date the time, unless a custom label has been entered for that key.

After saving to a register, you remain in the Save State menu, so that you can see the Register key update. After saving to a file, the analyzer automatically returns to the previous menu and any Save As dialog goes away.

**Backwards** :MMEMory:STORE:STATe 1,<filename>

**Compatibility SCPI** For backwards compatibility, the above syntax is supported. The "1" is simply ignored. The command is sequential.

**Initial S/W Revision** Prior to A.02.00

### To File . . .

When you press “To File”, the analyzer brings up a Windows dialog and a menu entitled “Save As.” This menu allows you to navigate to the various fields in the Windows dialog without using a keyboard or mouse. The Tab and Arrow keys can also be used for dialog navigation.

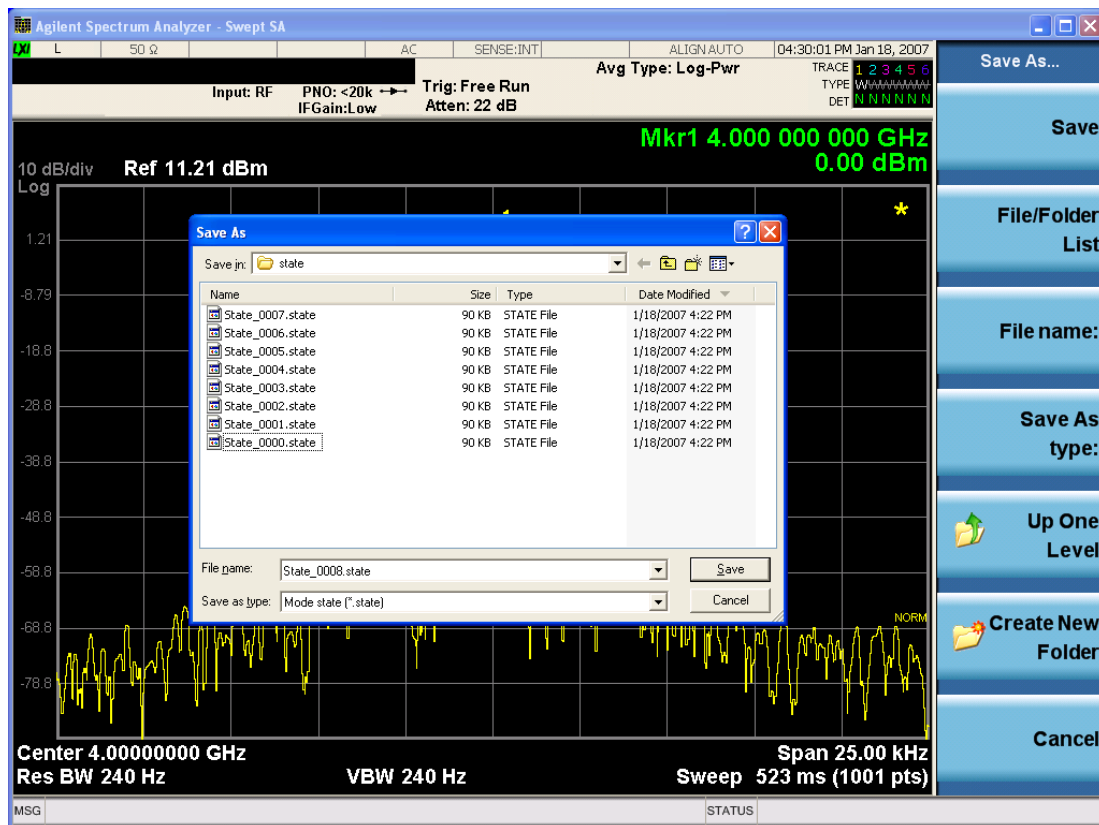

The Listed below

are the functions of the various fields in the dialog, and the corresponding softkeys:

#### Save

Performs the save to the specified file of the selected type. If the file already exists, a dialog will appear that allows you to replace the existing file by selecting OK, or you can Cancel the request. If you select OK,



the file will be overwritten. Using the C: drive is strongly discouraged, since it runs the risk of being overwritten during an instrument software upgrade.

While the save is being performed, the floppy icon appears briefly in the Meas bar.

#### File/Folder List

Enables you to navigate to the center of the dialog that contains the list of files and folders. Once here you can get information about the file and use the tab keys to navigate to the other fields in the dialog, such as Save In.

#### Save In

The Save In field shows the path to which the file will be saved and allows you to change the path using the up and down arrow keys to navigate to other paths; the Enter key to open a directory; and the Backspace key to go back one directory. The **Save In field** defaults to the default path for this type of file and remembers the last path you used to save this type of file. There is no softkey for directly navigating to the Save In field but you can use left tab to get here from the File/Folder List.

User specified paths are remembered when you leave and return to a Mode and are reset back to the default using Restore Mode Defaults.

#### File Name

The File Name field is initially loaded with an automatically generated filename specific to the appropriate Save Type. The automatically generated filename is guaranteed not to conflict with any filename currently in the directory. You may replace or modify this filename using the File Name key. See the ["Quick Save " on page 1332](#) documentation for more on the automatic file naming algorithm.

When you press the File Name key the analyzer displays the Alpha Editor. Use the knob to choose the letter to add and the front-panel Enter key to add the letter to the file name. The BK character moves you back and the FW character moves you forward in the filename. The Select key on the front panel generates a space character. When you are done entering the filename press the Done softkey. This returns back to the **File Open** dialog and menu, but does not cause the save to occur.

#### Save As Type

This field shows the file suffix for the type of file you have selected to save. For example, if you navigated here while saving State, "Mode state (\*.state)" is in the field. If you navigated here from saving Trace, ""Mode state (\*.trace)" is in the field. If you navigated here while exporting a trace data file, "Trace Data (\*.csv)" is in the field. For some file types, there is more than one choice in the dropdown, which you can select by using the up and down arrow keys and Enter.

#### Up One Level

This key corresponds to the icon of a folder with the up arrow that is in the tool bar of the dialog. When pressed, it causes the file and folder list to navigate up one level in the directory structure. The Backspace key does the same thing.

#### Create New Folder

This key corresponds to the icon of a folder with the "\*" that is in the tool bar of the dialog. When pressed, a new folder is created in the current directory with the name **New Folder** and you can enter a new folder name using the Alpha Editor.

#### Cancel

This key corresponds to the Cancel selection in the dialog. It causes the current **Save As** request to be cancelled. The ESC key does the same thing.

Key Path	Save, State
Mode	All
Notes	Brings up Save As dialog for saving a State Save Type
Initial S/W Revision	Prior to A.02.00

## Edit Register Names

You may enter a custom name on any of the Register keys, to help you remember what you are using that state to save. To do this, press the Edit Register Names key, choose the register whose name you wish to edit, and then enter the desired label using the Alpha Editor or an external PC keyboard.

The maximum number of characters that can be added is 30. In most cases, 30 characters will fit on two lines of the key.

See ["More Information" on page 374](#)

Key Path	Save, State
Mode	All
<b>Remote Command</b>	:MMEMory:REGister:STATe:LABel <reg number>,"label" :MMEMory:REGister:STATe:LABel? <reg number>
<b>Example</b>	:MMEM:REG:STAT:LAB 1,"my label"
Notes	<reg number> is an integer from 1 to 16. If the SCPI specifies an invalid register number an error message is generated, -222,"Data out of range;Invalid register label number" "label" is a string from 0 to 30 characters in length. If a label exceeds 30 characters, an error message is generated, -150,"String data error;Label clipped to 30 characters" "label" of length 0 erases the custom label and restores the default (time and date) label. E.g.: :MMEM:REG:STAT:LAB 1,""
Dependencies	N9060A-7FP or N9060B-2FP license required to edit the register names. When the feature is not licensed, sending this command generates an error, -221,"Settings conflict;Option not available"
Preset	The names are unaffected by Preset or power cycle but are set to the default label (time and date) on a "Restore System Defaults->Misc"
Initial S/W Revision	A.11.00

## More Information

When you edit one of the register names, the time and date field will be replaced by the custom name.

If you delete all the characters in the custom name, it restores the default (time and date).

The register names are stored within the state files, but they are not part of the instrument state; that is, once you have edited a register name, loading a new state will not change that register name. Another

consequence of this is that the names will be persistent through a power cycle. Also, if a named state file is transferred to another analyzer, it will bring its custom name along with it.

If you try to edit the name of an empty register, the analyzer will first save the state to have a file to put the name in. If you load a named state file into an analyzer with older firmware it will ignore the metadata.

The \*SAV and \*RCL commands will not be affected by the custom register names, nor will the MMEM commands.

## Register 1 thru Register 16

Selecting any one of these register menu keys causes the State of the currently active mode to be saved to the specified Register. The registers are provided for rapid saving and recalling, since you do not need to specify a filename or navigate to a file. Each of the register menu keys annotates whether it is empty or at what date and time it was last modified. In addition, you can use the Edit Register Names key to enter custom names for each register.

### NOTE

In products that run multiple instances of the X-Series Application, save with different register name if you do not want to overwrite the register of another running instance.

Although these 16 registers are the only registers available from the front panel, there are 128 state registers available in the instrument. Registers 17–128 are only available from the SCPI interface, using the \*SAV command.

There is one set of 128 state registers in the instrument, not one set for each Mode. When a state is saved, the Mode it was saved from is saved with it; then when it is recalled, the instrument switches to that Mode.

After the save completes, the corresponding register menu key annotation is updated with the date and time and the message "Register <register number> saved" is displayed.

Key Path	Save, State
Mode	All
Example	*SAV 1
Range	1–16 from front panel, 1–128 from SCPI
Readback	Date and time with seconds resolution are displayed on the key OR A custom name of up to 30 characters entered using the Edit Register Names key OR “(empty)” if no prior save operation has been performed to this register.
Initial S/W Revision	Prior to A.02.00
Modified at S/W Revision	A.11.00

## Register 1 thru Register 16

Selecting any one of these register menu keys causes the State of the currently active mode to be saved to the specified Register. The registers are provided for rapid saving and recalling, since you do not need to specify a filename or navigate to a file. Each of the register menu keys annotates whether it is empty or at

what date and time it was last modified. In addition, you can use the Edit Register Names key to enter custom names for each register.

**NOTE** In products that run multiple instances of the X-Series Application, save with different register name if you do not want to overwrite the register of another running instance.

Although these 16 registers are the only registers available from the front panel, there are 128 state registers available in the instrument. Registers 17–128 are only available from the SCPI interface, using the \*SAV command.

There is one set of 128 state registers in the instrument, not one set for each Mode. When a state is saved, the Mode it was saved from is saved with it; then when it is recalled, the instrument switches to that Mode.

After the save completes, the corresponding register menu key annotation is updated with the date and time and the message "Register <register number> saved" is displayed.

Key Path	Save, State
Mode	All
<b>Example</b>	*SAV 1
Range	1–16 from front panel, 1–128 from SCPI
Readback	Date and time with seconds resolution are displayed on the key OR A custom name of up to 30 characters entered using the Edit Register Names key OR “(empty)” if no prior save operation has been performed to this register.
Initial S/W Revision	Prior to A.02.00
Modified at S/W Revision	A.11.00

### Mass Storage Catalog (Remote Command Only)

Key path	SCPI Only
<b>Remote Command</b>	:MMEMory:CATalog? [<directory_name>]
Notes	The string must be a valid logical path. Queries disk usage information (drive capacity, free space available) and obtains a list of files and directories in a specified directory in the following format: <numeric_value>,<numeric_value>,{<file_entry>} It returns two numeric parameters and as many strings as there are files and directories. The first parameter indicates the total amount of storage currently used in bytes. The second parameter indicates the total amount of storage available, also in bytes. The <file_entry> is a string. Each <file_entry> indicates the name, type, and size of one file in the directory list: <file_name>,<file_type>,<file_size> As the windows file system has an extension that indicates file type, <file_type> is always empty. <file_size> provides the size of the file in bytes. For directories, <file_entry> is surrounded by square brackets and both <file_type> and <file_size> are empty
Initial S/W Revision	Prior to A.02.00

## Mass Storage Change Directory (Remote Command Only)

Key path	SCPI Only
<b>Remote Command</b>	:MMEMory:CDIRectory [<directory_name>] :MMEMory:CDIRectory?
Notes	<p>The string must be a valid logical path.</p> <p>Changes the default directory for a mass memory file system. The &lt;directory_name&gt; parameter is a string. If no parameter is specified, the directory is set to the *RST value.</p> <p>At *RST, this value is set to the default user data storage area, that is defined as System.Environment.SpecialFolder.Personal.</p> <p>Query returns full path of the default directory.</p>
Initial S/W Revision	Prior to A.02.00

## Mass Storage Copy (Remote Command Only)

Key path	SCPI Only
<b>Remote Command</b>	:MMEMory:COPY <string>,<string>[,<string>,<string>]
Notes	<p>The string must be a valid logical path.</p> <p>Copies an existing file to a new file or an existing directory to a new directory.</p> <p>Two forms of parameters are allowed. The first form has two parameters. In this form, the first parameter specifies the source, and the second parameter specifies the destination.</p> <p>The second form has four parameters. In this form, the first and third parameters specify the source. The second and fourth parameters specify the directories. The first pair of parameters specifies the source. The second pair specifies the destination. An error is generated if the source doesn't exist or the destination file already exists.</p> <p>This command will generate an "access denied" error if the destination is a restricted folder (e.g., C:\Windows) and the current user does not have Power User or Administrator privileges.</p>

## Mass Storage Device Copy (Remote Command Only)

This command transfers data to/from a file and a peripheral device.

Key path	SCPI Only
<b>Remote Command</b>	:MMEMory:COPY:DEvice <source_string>,<dest_string>
Notes	<p>The strings must be a valid logical path or a valid device keyword. If the dest_string is a device keyword, the data is copied from the source file to the device. If the source_string is a device keyword, the data is copied to the source file from the device.</p> <p>Valid device keywords are:</p> <p>SNS (smart noise source)</p> <p>An error is generated if the file or device is not found.</p>

## Mass Storage Delete (Remote Command Only)

Key path	SCPI Only
<b>Remote Command</b>	:MMEMory:DELeTe <file_name>[,<directory_name>]
Notes	The string must be a valid logical path. Removes a file from the specified directory. The <file_name> parameter specifies the file name to be removed. This command will generate an "access denied" error if the file is in a restricted folder (e.g., C:\Windows) and the current user does not have Power User or Administrator privileges.
Initial S/W Revision	Prior to A.02.00

## Mass Storage Data (Remote Command Only)

Creates a file containing the specified data OR queries the data from an existing file.

Key path	SCPI Only
<b>Remote Command</b>	:MMEMory:DATA <file_name>, <data> :MMEMory:DATA? <file_name>
Notes	The string must be a valid logical path. The command form is MMEMory:DATA <file_name>,<data>. It loads <data> into the file <file_name>. <data> is in 488.2 block format. <file_name> is string data. The query form is MMEMory:DATA? <file_name> with the response being the associated <data> in block format.
Initial S/W Revision	Prior to A.02.00

## Mass Storage Make Directory (Remote Command Only)

Key path	SCPI Only
<b>Remote Command</b>	:MMEMory:MDIRectory <directory_name>
Notes	The string must be a valid logical path. Creates a new directory. The <directory_name> parameter specifies the name to be created. This command will generate an "access denied" error if the new directory would be in a restricted folder (e.g., C:\Windows) and the current user does not have Power User or Administrator privileges.
Initial S/W Revision	Prior to A.02.00

## Mass Storage Move (Remote Command Only)

Key path	SCPI Only
<b>Remote Command</b>	:MMEMory:MOVE <string>,<string>[,<string>,<string>]
Notes	The string must be a valid logical path. Moves an existing file to a new file or an existing directory to a new directory.

---

Two forms of parameters are allowed. The first form has two parameters. In this form, the first parameter specifies the source, and the second parameter specifies the destination.

The second form has four parameters. In this form, the first and third parameters specify the source. The second and fourth parameters specify the directories. The first pair of parameters specifies the source. The second pair specifies the destination. An error is generated if the source doesn't exist or the destination file already exists.

This command will generate an "access denied" error if the destination is a restricted folder (e.g., C:\Windows) and the current user does not have Power User or Administrator privileges.

---

Initial S/W Revision      Prior to A.02.00

---

### Mass Storage Remove Directory (Remote Command Only)

---

Key path                      SCPI Only

**Remote Command**        :MMEMory:RDIrectory <directory\_name>

Notes                         The string must be a valid logical path.

Removes a directory. The <directory\_name> parameter specifies the directory name to be removed. All files and directories under the specified directory shall also be removed.

This command will generate an "access denied" error if the folder is a restricted folder (e.g., C:\Windows) or is in a restricted folder and the current user does not have Power User or Administrator privileges.

---

Initial S/W Revision        Prior to A.02.00

---

### Mass Storage Determine Removable Media (Remote Command Only)

This command is used to determine if any removable media devices are connected to the instrument. Primarily, these are USB memory devices plugged-in to the front panel or rear panel USB ports. On instruments with PC6 or PC7 CPU's, one SD card slot is available for removable media. The instrument's primary disk drive is not a removable media device.

---

Key Path                      SCPI Only

**Remote Command**        :MMEMory:RMEDia:LIST?

Notes                         The return value will be a string containing a list of partition identifiers which are removable media devices. Each identifier will be separated by a comma. If no removable media is present, an empty string will be returned.

Examples:

One removable device present will result in a return string of "F:".

Two removable devices present will result in a return string of "F:,G:".

No removable devices present will result in a return string of "".

---

Initial S/W Revision        x.15.00

---

### Mass Storage Determine Removable Media Label (Remote Command Only)

This command is used to set or query a removable media device's label.

Key Path	SCPI Only
Remote Command	:MMEMory:RMEDIA:LABel <partition>,<string> :MMEMory:RMEDIA:LABel? <partition>
Example	MMEM:RMED:LAB "F:","My Device"
Notes	If the <partition> specified does not exist or is not a removable media device the error -252,"Missing Media" will be generated. Setting the removable media label requires Administrative privileges. If the currently logged in user does not have appropriate privileges the error "-221.9900,Settings conflict;Administrator privileges required" is generated.
Initial S/W Revision	x.15.00

### Mass Storage Determine Removable Media Write-protect status (Remote Command Only)

This command is used to query a removable media device's write-protect status.

Key Path	SCPI Only
Remote Command	:MMEMory:RMEDIA:WPRotect? <partition>
Example	MMEM:RMED:WPR? "F:"
Notes	The return value is 1 if the device is write-protected, and 0 if the device is write-enabled. If the <partition> specified does not exist or is not a removable media device the error -252,"Missing Media" will be generated.
Preset	The return value will be depending on SD card installed.
Initial S/W Revision	x.15.00

### Mass Storage Determine Removable Media size (Remote Command Only)

This command is used to query a removable media device's total memory size (not available memory size).

Key Path	SCPI Only
Remote Command	:MMEMory:RMEDIA:SIZE? <partition>
Example	MMEM:RMED:SIZE? "F:"
Notes	The return value is integer value in GBytes. Any device which is less than 1 GB will return 0 GB. If the <partition> specified does not exist or is not a removable media device the error -252,"Missing Media" will be generated.
Initial S/W Revision	x.15.00



## Sequences

These keys allow you to save a Tab separated or CSV file of the setup parameters required to build a Sequence.

In order to save you must select the Save As button and choose a destination folder.

Key Path	Save, Sequences
Mode	All
Remote Command	:MMEM:STOR:SEquences:   SLIS   ALIS   SAALIS   SStep "MySequence.txt"
Example	:MMEM:STOR:SEQ:SLIS "MySequence.txt"
Notes	Available file types are: –CSV (Comma delimited) (*.csv) –Text (Tab delimited) (*.txt)
Initial S/W Revision	A.05.00

## Source Sequence

The list of parameters, that configure steps, that makes up a sequence for the Source.

The Source sequence is a sequence of flexible configurable steps that can be set anywhere in the instruments frequency range.

Key Path	Save, Sequences
Example	:MMEM:STOR:SEQ:SLIS "MySequence.txt"
Dependencies	Only available in XOBT
Initial S/W Revision	A.05.00

## Save As . . .

This menu lets you select the location where you can save the Sequence. This menu is a standard Windows® dialog with Save As menu keys. The "File Name" field in the Save As dialog is initially loaded with an automatically generated filename specific to the appropriate Save Type. The automatically generated filename is guaranteed not to conflict with any filename currently in the directory. You may replace or modify this filename using the File Name softkey. See the Quick Save key documentation for more on the automatic file naming algorithm.

The default path for all Sequence Files is:

My Documents\Sequences

Key Path	Save, Sequences
Mode	All

Notes	Brings up Save As dialog for saving a Sequence Save Type
Initial S/W Revision	A.05.00

## Data (Export)

Exporting a data file stores data from the current measurement to mass storage files. The Export Menu only contains data types that are supported by the current measurement.

Since the commonly exported data files are in .csv format, the data can be edited by you prior to importing. This allows you to export a data file, manipulate the data in Excel (the most common PC Application for manipulating .csv files) and then import it.

Selecting an Export Data menu key will not actually cause the exporting to occur, since the analyzer still needs to know where you wish to save the data. Pressing the Save As key in this menu brings up the Save As dialog and Save As menu that allows you to specify the destination file and directory. Once a filename has been selected or entered in the Open menu, the export will occur as soon as the Save key is pressed.

Key Path	Save
Mode	All
Notes	The menu is built from whatever data types are available for the mode. So the key locations in the sub menu will vary. No SCPI command directly controls the Data Type that this key controls. The Data Type is included in the MMEM:STOR commands.
Dependencies	If a file type is not used by a certain measurement, that type is grayed out for that measurement. The key for a file type will not show at all if there are no measurements in the Mode that support it.
Preset	Is not affected by a Preset or shutdown, but is reset during Restore Mode Defaults
Readback	The data type that is currently selected
Initial S/W Revision	Prior to A.02.00

## Measurement Results

Pressing this key selects Meas Results as the data type to be exported.

The Meas Results file contains information which describes the current state of the analyzer. It is detailed in Meas Result File Contents below.

Key Path	Save, Data
Remote Command	:MMEMory:STOR:RESults <string>
Example	:MMEM:STOR:RES "MeasR_0000.csv"
Notes	If the save is initiated via SCPI and the file already exists, the file will be overwritten. The SCPI command exports Channel Power measurement results to the file specified as the parameter in the current path. The default path is My Documents\<current mode>\data\CHP\results.

	Using the C: drive is strongly discouraged, since it runs the risk of being overwritten during an instrument software upgrade. The SCPI parameter is a quoted string, which specifies the filename. Both single and double quotes are supported for any filename parameter over SCPI.
Dependencies	The current active measurement must be the Channel Power measurement to use this command.
Status Bits/OPC dependencies	Sequential – waits for the previous measurement to complete.
Initial S/W Revision	Prior to A.02.00

### Meas Results File Contents

A Meas Results File contains measurement results with the following information.

- File ID string, which is “MeasResult”
- Measurement ID following Mode ID, which is “SA:CHP” for example.
- Firmware rev and model number
- Option string
- Auto Sweep Time Rules
- Average Mode
- Average Number
- Average State
- Center Frequency
- Detector
- Electrical Atten
- Electrical Atten State
- IFGain
- IFGainAuto
- Impedance
- Integ BW
- Internal Preamp
- Internal Preamp Band
- Mechanical Atten
- MechanicalAttenStepEnum
- PSD Unit
- Resolution Band Width

- Resolution Bandwidth Shape
- RRC Filter Alpha
- RRC Filter BW
- RRC Filter State
- Span
- Sweep Points
- Sweep Time
- Sweep Time Auto
- TriggerSource
- Video Bandwidth
- Y Axis Unit

The file contains these data followed by MeasResult1 and MeasResult2 that flag the start of the measurement results. Each line of Measurement Results consists of two comma separated values, MeasResult1 value and MeasResult2 value. MeasResult1 contains the same results as MEAS/READ/FETCH:CHPower1; MeasResult2, MEAS/READ/FETCH:CHPower2.

Exported file is .csv file. The Meas Results file, when imported into Excel, will show the following data:

<b>MeasResult</b>	
SA:CHP	
A.10.53	N9030A
526 ALV ATP B1X B1Y B25 B40 BBA CR3 CRP DCF DDA DP2 DRD EA3 EDP EMC EP1 ERC ESC ESP EXM FSA LFE LNP MAT MPB NFE NUL P26 PFR PNC RTL RTS S40 SB1 SEC SM1 TVT YAS YAV	1
Auto Sweep Time Rules	Normal
Average Mode	Exponential
Average Number	10
Average State	TRUE
Center Frequency	13255000000
Detector	Average
IFGain	FALSE
IFGainAuto	FALSE
Impedance	50
Integ BW	2000000
Internal Preamp	FALSE
Internal Preamp Band	Low
PSD Unit	DbmHz

Resolution Band Width	27000
Resolution Bandwidth Shape	Gaussian
RRC Filter Alpha	0.22
RRC Filter BW	3840000
RRC Filter State	FALSE
Span	3000000
Sweep Points	1001
Sweep Time	0.004933333
Sweep Time Auto	TRUE
TriggerSource	Free
Video Bandwidth	270000
Y Axis Unit	DecibelMilliwatt
MeasResult1	MeasResult2
-76.8141133132837	-95.29174
-139.824413269924	-94.99601
	-94.95281
	-95.17146

## Zone Map

Pressing this key selects Zone Map as the data type to be exported.

The Zone Map file contains information about current Zone Map configuration. Its format is compatible with the 89601A OFDMA map file. It is detailed in ["Zone Map File Contents" on page 386](#) below.

Key Path	Save, Data
<b>Remote Command</b>	:MMEMory:STORe:ZMAP <string>
<b>Example</b>	MMEM:STOR:ZMAP "ZMap_0000.omf"
Notes	<p>If the save is initiated via SCPI and the file already exists, the file will be overwritten.</p> <p>The SCPI command exports Zone Map information to the file specified as the parameter in the current path. The default path is My Documents\WIMAXOFDMA\.</p> <p>Using the C: drive is strongly discouraged, since it runs the risk of being overwritten during an instrument software upgrade.</p> <p>The SCPI parameter is a quoted string that specifies the filename. Both single and double quotes are supported for any filename parameter over SCPI.</p>
Dependencies	You must be in the 802.16 OFDMA (WiMAX/WiBro) mode.
Status Bits/OPC dependencies	Sequential – waits for the previous measurement to complete.
Initial S/W Revision	Prior to A.02.00

## Zone Map File Contents

A Zone Map File contains the following information of the Zone Map configuration. See ["Zone Map Data" on page 171](#) for detailed definitions.

- DemodOfdmaMap\_AutoDetect
- DemodOfdmaMap\_Count
- DemodOfdmaMap\_F1\_DL\_Count
- DemodOfdmaMap\_F1\_DL\_Z1\_Active
- DemodOfdmaMap\_F1\_DL\_Z1\_AmcType
- DemodOfdmaMap\_F1\_DL\_Z1\_B1\_Active
- DemodOfdmaMap\_F1\_DL\_Z1\_B1\_AllocType
- DemodOfdmaMap\_F1\_DL\_Z1\_B1\_Boost
- DemodOfdmaMap\_F1\_DL\_Z1\_B1\_BurstType
- DemodOfdmaMap\_F1\_DL\_Z1\_B1\_ColorIndex
- DemodOfdmaMap\_F1\_DL\_Z1\_B1\_ModType
- DemodOfdmaMap\_F1\_DL\_Z1\_B1\_Name
- DemodOfdmaMap\_F1\_DL\_Z1\_B1\_SubchannelInterval
- DemodOfdmaMap\_F1\_DL\_Z1\_B1\_SubchannelOffset
- DemodOfdmaMap\_F1\_DL\_Z1\_B1\_SymbolInterval
- DemodOfdmaMap\_F1\_DL\_Z1\_B1\_SymbolOffset
- DemodOfdmaMap\_F1\_DL\_Z1\_Count
- DemodOfdmaMap\_F1\_DL\_Z1\_DedicPilots
- DemodOfdmaMap\_F1\_DL\_Z1\_IDCell
- DemodOfdmaMap\_F1\_DL\_Z1\_IDCellCouple
- DemodOfdmaMap\_F1\_DL\_Z1\_Len
- DemodOfdmaMap\_F1\_DL\_Z1\_Locked
- DemodOfdmaMap\_F1\_DL\_Z1\_Name
- DemodOfdmaMap\_F1\_DL\_Z1\_PrbsID
- DemodOfdmaMap\_F1\_DL\_Z1\_StcMatrix
- DemodOfdmaMap\_F1\_DL\_Z1\_StcType
- DemodOfdmaMap\_F1\_DL\_Z1\_SymOffset
- DemodOfdmaMap\_F1\_DL\_Z1\_UseAllSC
- DemodOfdmaMap\_F1\_DL\_Z1\_WrapType

- DemodOfdmaMap\_F1\_DL\_Z1\_ZoneType
- DemodOfdmaMap\_F1\_UL\_Count
- DemodOfdmaMap\_F1\_UL\_Z1\_Active
- DemodOfdmaMap\_F1\_UL\_Z1\_AmcType
- DemodOfdmaMap\_F1\_UL\_Z1\_B1\_Active
- DemodOfdmaMap\_F1\_UL\_Z1\_B1\_AllocType
- DemodOfdmaMap\_F1\_UL\_Z1\_B1\_Boost
- DemodOfdmaMap\_F1\_UL\_Z1\_B1\_BurstType
- DemodOfdmaMap\_F1\_UL\_Z1\_B1\_ColorIndex
- DemodOfdmaMap\_F1\_UL\_Z1\_B1\_ModType
- DemodOfdmaMap\_F1\_UL\_Z1\_B1\_Name
- DemodOfdmaMap\_F1\_UL\_Z1\_B1\_PilotPattern
- DemodOfdmaMap\_F1\_UL\_Z1\_B1\_StcMode
- DemodOfdmaMap\_F1\_UL\_Z1\_B1\_SubchannelInterval
- DemodOfdmaMap\_F1\_UL\_Z1\_B1\_SubchannelOffset
- DemodOfdmaMap\_F1\_UL\_Z1\_B1\_SymbolInterval
- DemodOfdmaMap\_F1\_UL\_Z1\_B1\_SymbolOffset
- DemodOfdmaMap\_F1\_UL\_Z1\_Count
- DemodOfdmaMap\_F1\_UL\_Z1\_Gap
- DemodOfdmaMap\_F1\_UL\_Z1\_IDCell
- DemodOfdmaMap\_F1\_UL\_Z1\_Len
- DemodOfdmaMap\_F1\_UL\_Z1\_Locked
- DemodOfdmaMap\_F1\_UL\_Z1\_Name
- DemodOfdmaMap\_F1\_UL\_Z1\_SymOffset
- DemodOfdmaMap\_F1\_UL\_Z1\_UseSubchRotate
- DemodOfdmaMap\_F1\_UL\_Z1\_WrapType
- DemodOfdmaMap\_F1\_UL\_Z1\_ZoneType
- DemodOfdmaMap\_Name
- DemodOfdmaMap\_RefreshMap

## Save As . . .

When you press “Save As”, the analyzer brings up a Windows dialog and a menu entitled “**Save As.**” This menu allows you to navigate to the various fields in the Windows dialog without using a keyboard or mouse. The Tab and Arrow keys can also be used for dialog navigation.

See "[To File . . .](#)" on page 1349 in Save, State for a full description of this dialog and menu.

The default path for saving files is:

For all of the Trace Data Files:

My Documents\`<mode name>`\data\traces

For all of the Limit Data Files:

My Documents\`<mode name>`\data\limits

For all of the Measurement Results Data Files:

My Documents\`<mode name>`\data\`<measurement name>`\results

For all of the Capture Buffer Data Files:

My Documents\`<mode name>`\data\captureBuffer

Key Path	Save, Data
Mode	All
Notes	The key location is mode-dependent and will vary. Brings up the Save As dialog for saving a <code>&lt;mode specific&gt;</code> Save Type. The save is performed immediately and does not wait until the measurement is complete.
Initial S/W Revision	Prior to A.02.00

## Screen Image

Pressing Screen Image accesses a menu of functions that enable you to specify a format and location for the saved screen image. It brings up a menu that allows you to specify the color scheme of the Screen Image (Themes) or navigate to the Save As dialog to perform the actual save.

Screen Image files contain an exact representation of the analyzer display. They cannot be loaded back onto the analyzer, but they can be loaded into your PC for use in many popular applications.

The image to be saved is actually captured when the Save front panel key is pressed, and kept in temporary storage to be used if you ask for a Screen Image save. When the Screen Image key is pressed, a "thumbnail" of the captured image is displayed, as shown below:



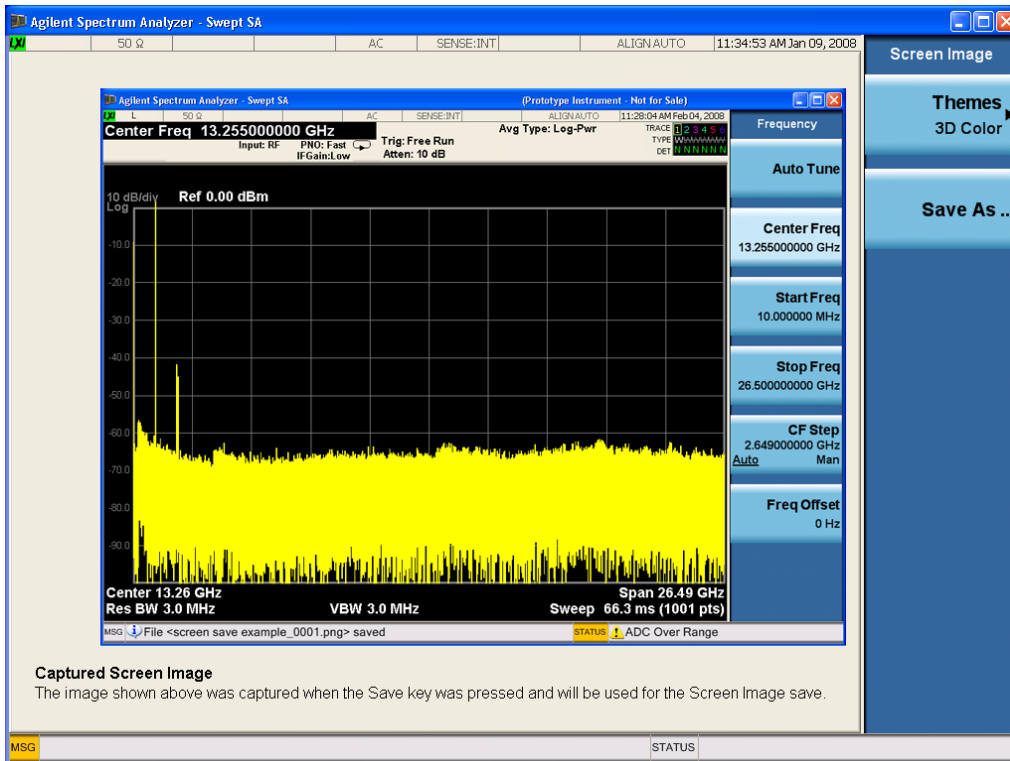

When you continue on into the Save As menu and complete the Screen Image save, the image depicted in the thumbnail is the one that gets saved, showing the menus that were on the screen before going into the Save menu. The save is performed immediately and does not wait until the measurement is complete.

After you have completed the save, the Quick Save front-panel key lets you quickly repeat the last save performed, using an auto-named file, with the current screen data.

**NOTE** For versions previous to A.01.55, if you initiate a screen image save by navigating through the Save menus, the image that is saved will contain the Save menu softkeys, not the menus and the active function that were on the screen when you first pressed the Save front panel key.

Key Path	Save
Mode	All
Remote Command	:MMEMory:STORe:SCReem <filename>
Example	:MMEM:STOR:SCR "myScreen.png" This stores the current screen image in the file MyScreenFile.png in the default directory.
Initial S/W Revision	Prior to A.02.00

## Themes

Accesses a menu of functions that enable you to choose the theme to be used when saving the screen image.

The **Themes** option is the same as the **Themes** option under the **Display** and **Page Setup** dialogs. It allows you to choose between themes to be used when saving the screen image.

<b>Key Path</b>	Save, Screen Image
<b>Remote Command</b>	:MMEMory:STORe:SCReem:THEMe TDColor   TDMonochrome   FCOLor   FMONochrome  :MMEMory:STORe:SCReem:THEMe?
<b>Example</b>	:MMEM:STOR:SCR:THEM TDM
<b>Preset</b>	3D Color; Is not part of Preset, but is reset by Restore Misc Defaults or Restore System Defaults All and survives subsequent running of the modes.
<b>Readback</b>	3D Color   3D Mono   Flat Color   Flat Mono
<b>Backwards Compatibility Notes</b>	In ESA and PSA we offer the choice of "Reverse Bitmap" or "Reverse Metafile" when saving screen images. This is much like the "Flat Color" theme available in X-Series. Also, if you selected Reverse Bitmap AND a black & white screen image, that would be much like "Flat Monochrome". In other words, each of the X-Series themes has a similar screen image type in ESA/PSA. But they are not identical.
<b>Initial S/W Revision</b>	Prior to A.02.00

### 3D Color

Selects a standard color theme with each object filled, shaded and colored as designed.

<b>Key Path</b>	Save, Screen Image, Themes
<b>Example</b>	MMEM:STOR:SCR:THEM TDC
<b>Readback</b>	3D Color
<b>Initial S/W Revision</b>	Prior to A.02.00

### 3D Monochrome

Selects a format that is like 3D color but shades of gray are used instead of colors.

<b>Key Path</b>	Save, Screen Image, Themes
<b>Example</b>	MMEM:STOR:SCR:THEM TDM
<b>Readback</b>	3D Mono
<b>Initial S/W Revision</b>	Prior to A.02.00

### Flat Color

Selects a format that is best when the screen is to be printed on an ink printer.

<b>Key Path</b>	Save, Screen Image, Themes
-----------------	----------------------------

<b>Example</b>	MMEM:STOR:SCR:THEM FCOL
Readback	Flat Color
Initial S/W Revision	Prior to A.02.00

### Flat Monochrome

Selects a format that is like Flat Color. But only black is used (no colors, not even gray), and no fill.

Key Path	Save, Screen Image, Themes
<b>Example</b>	MMEM:STOR:SCR:THEM FMON
Readback	Flat Mono
Initial S/W Revision	Prior to A.02.00

### Save As...

When you press "Save As", the analyzer brings up a Windows dialog and a menu entitled "**Save As.**" This menu allows you to navigate to the various fields in the Windows dialog without using a keyboard or mouse. The Tab and Arrow keys can also be used for dialog navigation.

See "[To File . . .](#)" on page 1349 in Save, State for a full description of this dialog and menu.

The default path for Screen Images is

My Documents\`<mode name>`\screen.

where `<mode name>` is the parameter used to select the mode with the INST:SEL command (for example, SA for the Spectrum Analyzer).

Key Path	Save, Screen Image
Notes	Brings up Save As dialog for saving a Screen Image Save Type
Initial S/W Revision	Prior to A.02.00

## Single (Single Measurement/Sweep)

Sets the analyzer for Single measurement operation. The single/continuous state is Meas Global, so the setting will affect all the measurements. If you are Paused, pressing Single does a Resume.

See "[More Information](#)" on page 392

Key Path	Front-panel key
Example	:INIT:CONT OFF
Notes	See Cont key description.
Backwards Compatibility Notes	<p>For Spectrum Analysis mode in ESA and PSA, the Single hardkey and the INITiate:IMM switched from continuous measurement to single measurement and restarted sweeps and averages (displayed average count reset to 1), but did not restart Max Hold and Min Hold. In the X-Series, the Single hardkey and the INITiate:IMM command initiate a sweep/ measurement/ average sequence/hold sequence including MaxHold and MinHold.</p> <p>For Spectrum Analysis mode in ESA and PSA, the Single hardkey restarted the sweep regardless of whether or not you were in an active sweep or sweep sequence. In the X-Series, Restart does this but Single only restarts the sweep or sweep sequence if you are in the idle state.</p> <p>INIT[:IMM] in ESA &amp; PSA Spectrum Analysis Mode does an implied ABORT. In some other PSA Modes, INIT[:IMM] is ignored if not in the idle state. . The X-Series follows the ESA/PSA SA Mode model, which may cause some Modes to have compatibility problems.</p>
Initial S/W Revision	Prior to A.02.00

### More Information

See "[Restart](#)" on page 1346 for details on the INIT:IMMEDIATE (Restart) function.

If you are already in single sweep, the INIT:CONT OFF command has no effect.

If you are already in Single Sweep, then pressing the Single key in the middle of a sweep does not restart the sweep or sequence. Similarly, pressing the Single key does not restart the sweep or sequence if the sweep is not in the idle state (for example, if you are taking a very slow sweep, or the analyzer is waiting for a trigger). Instead, it results in a message. "Already in Single, press Restart to initiate a new sweep or sequence". Even though pressing the Single key in the middle of a sweep does not restart the sweep, sending INIT:IMMEDIATE does reset it.

To take one more sweep without resetting the average count, increment the average count by 1, by pressing the step up key while **Average/Hold Number** is the active function, or sending the remote command CALC:AVER:TCON UP.

## Source

Opens a menu of keys that access various source configuration menus and settings. In the test set, pressing this key also causes the central view area to change and display the Source Control Main view.

Key Path	Front-panel key
----------	-----------------

## RF Output

This parameter sets the source RF power output state.

Key Path	Source
<b>Remote Command</b>	:OUTPut[:EXTernal][:STATe] ON OFF 1 0 :OUTPut[:EXTernal][:STATe]?
<b>Example</b>	OUTP OFF OUTP?
Notes	<p>The EXTERNAL node is shown in RD text so the SCPI remains the same between internal and external source control. However, for EXT we do not wish to document this node to the customer since we are controlling the internal source rather than the external source.</p> <p>This setting is for the independent mode and has no effect on the "List Sequencer" on page 1449. If the "Sequencer" on page 1449 is set to ON, the list sequencer controls the source output and this key will be grayed-out. And this setting will be none-forceful grey out on front panel to indicate out-of-scope. Non-forceful means user still can change this setting by SCPI but cannot change on front panel. When set to OFF will make source leave list sequencer and this setting will be black out and take effect immediately.</p> <p>When the RF Output is ON, an "RF" annunciator is displayed in the system settings panel. When the RF Output is turned Off, the RF annunciator is cleared. If the "Sequencer" on page 1449 is set to ON, the "RF" annunciator will be replaced by "SEQ" in the system settings panel, indicating that the output is controlled by the list sequencer.</p>
Preset	Off
Range	On   Off
Initial S/W Revision	A.05.00

## Amplitude

Allows you to access the Amplitude sub-menu.

Key Path	Source
Notes	<p>The sub-menu under this button is for independent mode and has no effect on "List Sequencer" on page 1449. If the "Sequencer" on page 1449 is set to ON, the list sequencer controls the source output and this key will be grayed-out on front panel to indicate out-of-scope. When you set "Sequencer" on page 1449 to Off will make source leave list sequencer and this button will be black out.</p>
Initial S/W Revision	A.05.00

## RF Power

Allows you to adjust the power level of the source using the numeric keypad, step keys, or RPG. Pressing any digit, 0 through 9, on the numeric keypad brings up the unit terminator.

Please refer to the ["RF Power Range " on page 395](#) table below for the valid ranges.

<b>Key Path</b>	Source, Amplitude
<b>Remote Command</b>	:SOURce:POWer[:LEVel][:IMMediate][:AMPLitude] <ampl> :SOURce:POWer[:LEVel][:IMMediate][:AMPLitude]?
<b>Example</b>	:SOUR:POW -100 dBm
<b>Notes</b>	<p>Amplitude corrections can be specified for use with the source. In the event of amplitude corrections being applied, the valid ranges for the RF power do not change dependant on the current amplitude correction setting. If the combination of RF power + amplitude correction is higher or lower than the source output range, the Source Unleveled bit is set and the "Source Unleveled" indicator will appear on status panel to indicate that the source cannot maintain the output power that has been requested.</p> <p>When signal generator is unable to maintain the requested output level, the "Source Unleveled" indicator will appear on status panel. When the source output setting is restored to the normal range, the "Source Unleveled" is removed from status panel.</p> <p>Internal source has list sequence mode, which comprises of several steps which contain separate output power, frequency and waveform etc. When the source list sequence playing is complete, the last step keeps playing, and user can use this command to change the list sequence last step's output power.</p> <p>The multiport adapter RFIO TX ports and GPS ports cannot ensure power accuracy when power setting is lower than -130dBm, this power setting value is defined by the sum of RF Power setting and related amplitude correction value. But user settable value could be lower than this limit. When application detected there exists power setting lower than -130dBm on MPA RFIO TX ports, then popup warning message . When application detected there exists power setting lower than -130dBm on MPA GPS ports, then popup warning message . This is only warning message, and check is performed when RF is ON.</p>
<b>Notes</b>	The Min and Max value here defined UI settable amplitude range. This range is larger than actual amplitude range with level accuracy defined in spec.
<b>Dependencies</b>	The RF power is dependent on the RF output port and frequency, such that the current frequency and selected output port determine the valid range of power values.
<b>Preset</b>	-100 dBm
<b>Min</b>	The range of values depends on the current frequency and selected RF output port. Please refer to the <a href="#">"RF Power Range " on page 395</a> table below for the valid ranges.
<b>Max</b>	The range of values depends on the current frequency and selected RF output port. Please refer to the <a href="#">"RF Power Range " on page 395</a> table below for the valid ranges.
<b>Initial S/W Revision</b>	A.05.00

All other models:

## RF Power Range

RF Output Port	Frequency Range	Min Output Power	Max Output Power
High Power RF Out	10 MHz $\leq$ f $\leq$ 6 GHz	-150 dBm	20 dBm
RFIO 1 & RFIO 2	10 MHz $\leq$ f $\leq$ 6 GHz	-150 dBm	0 dBm
GPS (Note2)	10 MHz $\leq$ f $\leq$ 6 GHz	-150 dBm	0 dBm

Note: This is the UI power range, it's larger than actual spec.

Note2: GPS port is on the multiport adapter, or E6607C which has embedded MPA.

M9420A:

## RF Power Range

RF Output Port	Frequency Range	Min Output Power	Max Output Power without Option "1EA"	Max Output Power with Option "1EA"
RF Output	60 MHz $\leq$ f $\leq$ 6 GHz	-150 dBm	10 dBm	18 dBm
RFHD	60 MHz $\leq$ f $\leq$ 6 GHz	-150 dBm	10 dBm	15 dBm
RFFD	60 MHz $\leq$ f $\leq$ 6 GHz	-150 dBm	0 dBm	0 dBm

## Set Reference Power

This key allows you to set the power reference. Pressing this key turns the power reference state to ON, sets the reference power value to the current RF output power, maintains this power at the RF output, and sets the displayed power to 0.00 dB. All subsequent RF power values entered under Source>Amplitude>RF Power are interpreted as being relative to this reference power.

When you use a power reference, the signal generator outputs an RF power that is set relative to the reference power by the value entered under Source>Amplitude>RF Power as follows:

Output power = reference power – entered power

Where:

reference power equals the original RF Power entered under Source>Amplitude>RF Power and set as the reference power

entered power equals a new value entered under Source>Amplitude>Amptd Offset

In addition, the displayed power value is the same as a new value entered under Source>Amplitude>RF Power.

**NOTE**

If Power Ref is set to ON with a reference value set, entering a value under Source>Amplitude>RF Power and pressing Set Reference Power will add that value to the existing Power Ref value.

If you wish to change the reference power value to a new value entered under Source>Amplitude>RF Power, first you must set Power Ref to OFF and then press Set Reference Power.

Key Path	Source, Amplitude
Dependencies	This key is unavailable, and is grayed out when the <a href="#">"List Sequencer" on page 1449</a> is turned ON.
Initial S/W Revision	A.05.00

## Power Ref

This key allows you to toggle the state of the power reference.

When you use a power reference, the signal generator outputs an RF power that is set relative to the reference power by the value entered under Source>Amplitude>RF Power as follows:

Output power = reference power + entered power

Where:

reference power equals the original RF Power entered under Source>Amplitude>RF Power and set as the reference power

entered power equals a new value entered under Source>Amplitude>Amptd Offset

For more information on Reference Frequency refer to ["Set Reference Power " on page 1380](#)

Key Path	Source, Amplitude
<b>Remote Command</b>	:SOURce:POWer:REFerence <ampl> :SOURce:POWer:REFerence? :SOURce:POWer:REFerence:STATe OFF ON 0 1 :SOURce:POWer:REFerence:STATe?
<b>Example</b>	:SOUR:POW:REF 0.00 dBm :SOUR:POW:REF:STATe ON
Dependencies	This setting is unavailable and is grayed out when the <a href="#">"List Sequencer" on page 1449</a> is turned ON.
Couplings	This value is coupled to the <a href="#">"Set Reference Power " on page 1380</a> key such that pressing the Set Reference Power key updates the reference power with the current output power.
Preset	0.00 dBm OFF
Min	-125.00 dBm
Max	10.00 dBm
Initial S/W Revision	A.05.00

## Amptd Offset

Allows you to specify the RF output power offset value.

When the amplitude offset is set to zero (0) and you set a new offset value (positive or negative), the displayed amplitude value will change as follows and the RF output power will not change:



Displayed value = output power + offset value

Where:

output power equals the original RF Power entered under Source>Amplitude>RF Power

offset value equals the value entered under Source>Amplitude>Amptd Offset

When the amplitude offset is set to a value other than zero (0) and you enter a new RF power value under Source>Amplitude>RF Power, the displayed power will be the same as the value entered and the RF output power will be equal to the value entered minus the offset value as follows:

Output power = entered power – offset power

Displayed Power = output power + offset power

Displayed power = entered power

Where:

entered power equals the amplitude entered under Source>Amplitude>RF Power

offset power equals the value previously entered and set under Source>Amplitude>Amptd Offset

Key Path	Source, Amplitude
<b>Remote Command</b>	:SOURce:POWer[:LEVel][:IMMediate]:OFFSet <rel_ampl> :SOURce:POWer[:LEVel][:IMMediate]:OFFSet?
<b>Example</b>	:SOUR:POW:OFFS 0.00 dB
Dependencies	This setting is unavailable, and is grayed out when the List Sequencer is turned ON.
Preset	0.00 dB
Min	-200.00 dB
Max	200.00 dB
Initial S/W Revision	A.05.00

## Modulation

Allows you to toggle the state of the modulation.

Key Path	Source
<b>Remote Command</b>	:OUTPut:MODulation[:STATe] ON OFF 1 0 :OUTPut:MODulation[:STATe]?
<b>Example</b>	:OUTP:MOD OFF
Notes	This setting is for independent mode and has no effect on " <a href="#">List Sequencer</a> " on page 1449. If the " <a href="#">Sequencer</a> " on page 1449 is set to ON, the list sequencer controls the source output and this key will be grayed-out. And this setting will be none-forceful grey out on front panel to indicate out-of-scope. Non-forceful means user still can change this setting by SCPI but cannot change manually on front panel. When set to Off will make source leave list sequencer and this setting will be black out and take effect immediately. When the Modulation is ON, the "MOD" annunciator is displayed in the system settings panel. When the Modulation is turned Off, the "MOD" annunciator is cleared. If the

	"Sequencer" on page 1449 is set to ON, the "MOD" annunciator will be replaced by "SEQ" in the system settings panel indicating that the output is controlled by list sequencer.
Preset	Off
Range	On   Off
Initial S/W Revision	A.05.00

## Frequency

Allows you to access the Frequency sub-menu.

Key Path	Source
Notes	The sub-menu under this button is for independent mode and has no effect on "List Sequencer" on page 1449. If the "Sequencer" on page 1449 is set to ON, the list sequencer controls the source output and this key will be grayed-out. And this button will be grey out on front panel to indicate out-of-scope. When set to Off will make source leave list sequencer and this button will be black out.
Initial S/W Revision	A.05.00

## Frequency

Allows you to set the RF Output Frequency. You can adjust the frequency of the source using the numeric keypad, step keys, or RPG. Pressing any digit, 0 through 9, on the numeric keypad brings up the unit terminator.

Key Path	Source, Frequency
Remote Command	:SOURce:FREQuency[:CW] <freq> :SOURce:FREQuency[:CW]?
Example	:SOUR:FREQ 1.00 GHz
Notes	Internal source has list sequence mode, which comprises of several steps which contain separate output power, frequency and waveform etc. When the source list sequence playing is complete, the last step keeps playing, and user can use this command to change the list sequence last step's output frequency.
Couplings	The frequency value is coupled to the current channel band and number, such that updates to the band and number will update the frequency value to the corresponding absolute frequency.
Preset	1.00 GHz If license F1A or 5WC is present, the default Center Frequency should be 2.412GHz.
Min	10.00 MHz
Max	Hardware Dependant: Option 503 = 3.6 GHz Option 504 = 3.8 GHz Option 506 = 6.00 GHz For E6640A, if license 5WC is present, the frequency range should be limited to: 1.1GHz-1.7GHz,

---

2.4GHz–2.5GHz, 4.8GHz–6.0GHz. If the user-defined frequency is outside of range, UI will report an error message called "Settings conflict; Frequency is outside available range".

---

Initial S/W Revision      A.05.00

---

## Channel

The frequency of the source can be specified by a channel number of a given frequency band. This key allows you to specify the current channel number. For the appropriate range of channel numbers for a given frequency band, refer to the following tables: ["GSM/EDGE Channel Number Ranges" on page 399](#), ["W-CDMA Channel Number Ranges" on page 400](#), ["CDMA 2000 / 1xEVDO Channel Number Ranges" on page 402](#), and ["LTE FDD Channel Number Ranges" on page 404](#).

Key Path	Source, Frequency
<b>Remote Command</b>	:SOURce:FREQuency:CHANnels:NUMBer <int> :SOURce:FREQuency:CHANnels:NUMBer?
<b>Example</b>	:SOUR:FREQ:CHAN:NUMB 1
Notes	This key is grayed out when the <a href="#">"Radio Standard" on page 1392</a> is set to NONE. This key is grayed out on E6630A.
Dependencies	This key is grayed out when the <a href="#">"Radio Standard" on page 1392</a> is set to NONE. This key is grayed out on E6630A.
Couplings	The channel number is coupled to the frequency value when the <a href="#">"Radio Standard" on page 1392</a> is not set to NONE. When the frequency value is changed, the channel number will increase or decrease to match the new frequency. If the frequency is not at an exact match for a channel number, the nearest channel number is displayed along with a greater than or less than sign to indicate the frequency is above or below the channel number.
Preset	1
Min	Please refer to the tables below for the valid ranges.
Max	Please refer to the tables below for the valid ranges.
Initial S/W Revision	A.05.00

## GSM/EDGE Channel Number Ranges

Band	Link (Device)	Range	Frequency (MHz)
P-GSM	Uplink (MS)	$1 \leq n \leq 124$	$890.0 + 0.2*n$
	Downlink (BS)	$1 \leq n \leq 124$	$935.0 + 0.2*n$
E-GSM	Uplink (MS)	$0 \leq n \leq 124$	$890.0 + 0.2*n$
		$975 \leq n \leq 1023$	$890.0 + 0.2*(n-1024)$
	Downlink (BS)	$0 \leq n \leq 124$	$935.0 + 0.2*n$
		$975 \leq n \leq 1023$	$935.0 + 0.2*(n-1024)$

Band	Link (Device)	Range	Frequency (MHz)
DCS 1800	Uplink (MS)	$512 \leq n \leq 885$	$1710.200 + 0.20*(n-512)$
	Downlink (BS)	$512 \leq n \leq 885$	$1805.200 + 0.20*(n-512)$
PCS 1900	Uplink (MS)	$512 \leq n \leq 810$	$1850.200 + 0.2*(n-512)$
	Downlink (BS)	$512 \leq n \leq 810$	$1930.200 + 0.2*(n-512)$
R-GSM	Uplink (MS)	$0 \leq n \leq 124$	$890.0 + 0.2*n$
		$955 \leq n \leq 1023$	$890.0 + 0.2*(n-1024)$
	Downlink (BS)	$0 \leq n \leq 124$	$935.0 + 0.2*n$
		$955 \leq n \leq 1023$	$935.0 + 0.2*(n-1024)$
GSM 450	Uplink (MS)	$256 \leq n \leq 293$	$450.6 + 0.2*(n-259)$
	Downlink (BS)	$256 \leq n \leq 293$	$460.6 + 0.2*(n-259)$
GSM 480	Uplink (MS)	$306 \leq n \leq 340$	$479.000 + 0.20*(n-306)$
	Downlink (BS)	$306 \leq n \leq 340$	$489.000 + 0.20*(n-306)$
GSM 850	Uplink (MS)	$128 \leq n \leq 251$	$824.200 + 0.20*(n-128)$
	Downlink (BS)	$128 \leq n \leq 251$	$869.200 + 0.20*(n-128)$
GSM 700	Uplink (MS)	$438 \leq n \leq 516$	$777.200 + 0.20*(n-438)$
	Downlink (BS)	$438 \leq n \leq 516$	$747.200 + 0.20*(n-438)$
T-GSM810	Uplink (MS)	$350 \leq n \leq 425$	$806.0 + 0.20*(n-350)$
	Downlink (BS)	$350 \leq n \leq 425$	$851.0 + 0.20*(n-350)$

### W-CDMA Channel Number Ranges

Band	Link (Device)	Range	Frequency (MHz)
Band I	Downlink	$10562 \leq n \leq 10838$	$n \div 5$
	Uplink	$9612 \leq n \leq 9888$	$n \div 5$
Band II	Downlink	$412 \leq n \leq 687$	$n \div 5 + 1850.1$
		$9662 \leq n \leq 9938$	$n \div 5$
	Uplink	$12 \leq n \leq 287$	$n \div 5 + 1850.1$
		$350 \leq n \leq 425$	$n \div 5$
Band III	Downlink	$1162 \leq n \leq 1513$	$n \div 5 + 1575$
	Uplink	$937 \leq n \leq 1288$	$n \div 5 + 1525$
Band IV	Downlink	$537 \leq n \leq 1738$	$n \div 5 + 1805$
		$1887 \leq n \leq 2087$	$n \div 5 + 1735.1$
	Uplink	$1312 \leq n \leq 1513$	$n \div 5 + 1450$
		$1662 \leq n \leq 1862$	$n \div 5 + 1380.1$
Band V	Downlink	$1007 \leq n \leq 1087$	$n \div 5 + 670.1$
		$4357 \leq n \leq 4458$	$n \div 5$

Band	Link (Device)	Range	Frequency (MHz)
	Uplink	$782 \leq n \leq 862$	$n \div 5 + 670.1$
		$4132 \leq n \leq 4233$	$n \div 5$
Band VI	Downlink	$1037 \leq n \leq 1062$	$n \div 5 + 670.1$
		$4387 \leq n \leq 4413$	$n \div 5$
	Uplink	$812 \leq n \leq 837$	$n \div 5 + 670.1$
		$4162 \leq n \leq 4188$	$n \div 5$
Band VII	Downlink	$2237 \leq n \leq 2563$	$n \div 5 + 2175$
		$2587 \leq n \leq 2912$	$n \div 5 + 2105.1$
	Uplink	$2012 \leq n \leq 2338$	$n \div 5 + 2100$
		$2362 \leq n \leq 2687$	$n \div 5 + 2030.1$
Band VIII	Downlink	$2937 \leq n \leq 3088$	$n \div 5 + 340$
	Uplink	$2712 \leq n \leq 2863$	$n \div 5 + 340$
Band IX	Downlink	$9237 \leq n \leq 9387$	$n \div 5$
	Uplink	$8762 \leq n \leq 8912$	$n \div 5$
Band X	Downlink	$3112 \leq n \leq 3388$	$n \div 5 + 1490$
		$3412 \leq n \leq 3687$	$n \div 5 + 1430.1$
	Uplink	$2887 \leq n \leq 3163$	$n \div 5 + 1135$
		$3187 \leq n \leq 3462$	$n \div 5 + 1075.1$
Band XI	Downlink	$3712 \leq n \leq 3812$	$n \div 5 + 736$
	Uplink	$3487 \leq n \leq 3587$	$n \div 5 + 733$
Band XII	Downlink	$3837 \leq n \leq 3903$	$n \div 5 - 37$
		$3927 \leq n \leq 3992$	$n \div 5 - 54.9$
	Uplink	$3612 \leq n \leq 3678$	$n \div 5 - 22$
		$3702 \leq n \leq 3767$	$n \div 5 - 39.9$
Band XIII	Downlink	$4017 \leq n \leq 4043$	$n \div 5 - 55$
		$4067 \leq n \leq 4092$	$n \div 5 - 64.9$
	Uplink	$3792 \leq n \leq 3818$	$n \div 5 + 21$
		$3702 \leq n \leq 3767$	$n \div 5 - 39.9$
Band XIV	Downlink	$4117 \leq n \leq 4143$	$n \div 5 - 63$
		$4167 \leq n \leq 4192$	$n \div 5 - 72.9$
	Uplink	$3892 \leq n \leq 3918$	$n \div 5 + 12$
		$3942 \leq n \leq 3967$	$n \div 5 + 2.1$
Band XIX	Downlink	$712 \leq n \leq 763$	$n \div 5 + 735$
		$787 \leq n \leq 837$	$n \div 5 + 720.1$
	Uplink	$312 \leq n \leq 363$	$n \div 5 + 770$
		$387 \leq n \leq 437$	$n \div 5 + 755.1$

### CDMA 2000 / 1xEVDO Channel Number Ranges

Band	Link (Device)	Range	Frequency (MHz)
US Cellular	Uplink (MS, reverse link)	$1 \leq N \leq 799$	$0.030 \times N + 825.000$
		$991 \leq N \leq 1023$	$0.030 \times (N - 1023) + 825.000$
		$1024 \leq N \leq 1323$	$0.030 \times (N - 1024) + 815.040$
	Downlink (BS, forward link)	$1 \leq N \leq 799$	$0.030 \times N + 870.000$
		$991 \leq N \leq 1023$	$0.030 \times (N - 1023) + 870.000$
		$1024 \leq N \leq 1323$	$0.030 \times (N - 1024) + 860.040$
US PCS	Uplink (MS, reverse link)	$0 \leq N \leq 1199$	$1850.000 + 0.050 \times N$
	Downlink (BS, forward link)	$0 \leq N \leq 1199$	$1930.000 + 0.050 \times N$
Japan Cellular Band	Uplink (MS, reverse link)	$1 \leq N \leq 799$	$0.0125 \times (N + 915.000)$
		$801 \leq N \leq 1039$	$0.0125 \times (N - 800) + 898.000$
		$1041 \leq N \leq 1199$	$0.0125 \times (N - 1040) + 887.000$
		$1201 \leq N \leq 1600$	$0.0125 \times (N - 1200) + 893.000$
	Downlink (BS, forward link)	$1 \leq N \leq 799$	$0.0125 \times (N + 860.000)$
		$801 \leq N \leq 1039$	$0.0125 \times (N - 800) + 843.000$
		$1041 \leq N \leq 1199$	$0.0125 \times (N - 1040) + 832.000$
		$1201 \leq N \leq 1600$	$0.0125 \times (N - 1200) + 838.000$
Korean PCS Band	Uplink (MS, reverse link)	$0 \leq N \leq 599$	$0.050 \times N + 1750.000$
	Downlink (BS, forward link)	$0 \leq N \leq 599$	$0.050 \times N + 1840.000$
NMT-450 Band	Uplink (MS, reverse link)	$1 \leq N \leq 400$	$0.025 \times (N - 1) + 450.000$
		$472 \leq N \leq 871$	$0.025 \times (N - 472) + 410.000$
		$1039 \leq N \leq 1473$	$0.020 \times (N - 1024) + 451.010$
		$1536 \leq N \leq 1715$	$0.025 \times (N - 1536) + 479.000$
		$1792 \leq N \leq 2016$	$0.020 \times (N - 1792) + 479.000$
	Downlink (BS, forward link)	$1 \leq N \leq 400$	$0.025 \times (N - 1) + 460.000$
		$472 \leq N \leq 871$	$0.025 \times (N - 472) + 420.000$
		$1039 \leq N \leq 1473$	$0.020 \times (N - 1024) + 461.010$
		$1536 \leq N \leq 1715$	$0.025 \times (N - 1536) + 489.000$
		$1792 \leq N \leq 2016$	$0.020 \times (N - 1792) + 489.000$
IMT-2000 Band	Uplink (MS, reverse link)	$0 \leq N \leq 1199$	$1920.000 + 0.050 \times N$
	Downlink (BS, forward link)	$0 \leq N \leq 1199$	$2100.000 + 0.050 \times N$
Upper 700 MHz Band	Uplink (MS, reverse link)	$0 \leq N \leq 240$	$776.000 + 0.050 \times N$
	Downlink (BS, forward link)	$0 \leq N \leq 240$	$746.000 + 0.050 \times N$

Band	Link (Device)	Range	Frequency (MHz)
	forward link)		
Secondary 800 MHz Band	Uplink (MS, reverse link)	$0 \leq N \leq 719$ $720 \leq N \leq 919$	$0.025 \times N + 806.000$ $0.025 \times (N - 720) + 896.000$
	Downlink (BS, forward link)	$0 \leq N \leq 719$ $720 \leq N \leq 919$	$0.025 \times N + 851.000$ $0.025 \times (N - 720) + 935.000$
2.5 GHz IMT Extension	Uplink (MS, reverse link)	$0 \leq N \leq 1399$	$2500.000 + 0.050 \times N$
	Downlink (BS, forward link)	$0 \leq N \leq 1399$	$2620.000 + 0.050 \times N$
US PCS 1.9 GHz	Uplink (MS, reverse link)	$0 \leq N \leq 1299$	$1850.000 + 0.050 \times N$
	Downlink (BS, forward link)	$0 \leq N \leq 1299$	$1930.000 + 0.050 \times N$
AWS	Uplink (MS, reverse link)	$0 \leq N \leq 899$	$1710.000 + 0.050 \times N$
	Downlink (BS, forward link)	$0 \leq N \leq 899$	$2100.000 + 0.050 \times N$
US 2.5 GHz	Uplink (MS, reverse link)	$140 \leq N \leq 1459$	$2495.000 + 0.050 \times N$
	Downlink (BS, forward link)	$140 \leq N \leq 1459$	$2617.000 + 0.050 \times N$
700 Public Safety	Uplink (MS, reverse link)	$0 \leq N \leq 240$	$787.000 + 0.050 \times N$
	Downlink (BS, forward link)	$0 \leq N \leq 240$	$757.000 + 0.050 \times N$
C2K Lower 700	Uplink (MS, reverse link)	$0 \leq N \leq 360$	$698.000 + 0.050 \times N$
	Downlink (BS, forward link)	$0 \leq N \leq 360$	$728.000 + 0.050 \times N$
400 Euro PAMR	Uplink (MS, reverse link)	$1 \leq N \leq 400$	$0.025 \times (N - 1) + 450.000$
		$472 \leq N \leq 871$	$0.025 \times (N - 472) + 410.000$
	Uplink (MS, reverse link)	$1536 \leq N \leq 1715$	$0.025 \times (N - 1536) + 479.000$
	Uplink (MS, reverse link)		
	Downlink (BS, forward link)	$1 \leq N \leq 400$	$0.025 \times (N - 1) + 460.000$
		$472 \leq N \leq 871$	$0.025 \times (N - 472) + 420.000$
	Downlink (BS, forward link)	$1536 \leq N \leq 1715$	$0.025 \times (N - 1536) + 489.000$

Band	Link (Device)	Range	Frequency (MHz)
800 PAMR	Uplink (MS, reverse link)	$0 \leq N \leq 239$	$870.0125 + 0.025 \times N$
	Downlink (BS, forward link)	$0 \leq N \leq 239$	$915.0125 + 0.025 \times N$

### LTE FDD Channel Number Ranges

The carrier frequency in the uplink and downlink is designated by the E-UTRA Absolute Radio Frequency Channel Number (EARFCN) in the range 0 – 65535. The relation between EARFCN and the carrier frequency in MHz for the downlink is given by the following equation, where FDL\_low and NOffs-DL are given in table 5.4.4–1 and NDL is the downlink EARFCN.

$$FDL = FDL\_low + 0.1(NDL - NOffs-DL)$$

The relation between EARFCN and the carrier frequency in MHz for the uplink is given by the following equation where FUL\_low and NOffs-UL are given in table 5.4.4–1 and NUL is the uplink EARFCN.

$$FUL = FUL\_low + 0.1(NUL - NOffs-UL)$$

Band	Downlink		Uplink			
	FDL_low (MHz)	NOffs-DL	Range of NDL	FUL_low (MHz)	NOffs-UL	Range of NUL
1		2110	0	0 – 599	1920	18000 – 18599
2		1930	600	600 – 1199	1850	18600 – 19199
3		1805	1200	1200 – 1949	1710	19200 – 19949
4		2110	1950	1950 – 2399	1710	19950 – 20399
5		869	2400	2400 – 2649	824	20400 – 20649
6		875	2650	2650 – 2749	830	20650 – 20749
7		2620	2750	2750 – 3449	2500	20750 – 20449
8		925	3450	3450 – 3799	880	21450 – 21799
9		1844.9	3800	3800 – 4149	1749.9	21800 – 22149
10		2110	4150	4150 – 4749	1710	22150 – 22749
11		1475.9	4750	4750 – 4949	1427.9	22750 – 22949



Band	Downlink	Uplink				
12	729	5010	5010 - 5179	699	23010	23010 - 23179
13	746	5180	5180 - 5279	777	23180	23180 - 23279
14	758	5280	5280 - 5379	788	23280	23280 - 23379
...						
17	734	5730	5730 - 5849	704	23730	23730 - 23849
18	860	5850	5850 - 5999	815	23850	23850 - 23999
19	875	6000	6000 - 6149	830	24000	24000 - 24149
20	791	6150	6150 - 6449	832	24150	24150 - 24449
21	1495.9	6450	6450 - 6599	1447.9	24450	24450 - 24599
...						
24	1525	7700	7700 - 8039	1626.5	25700	25700 - 26039
25	1930	8040	8040 - 8689	1850	26040	26040 - 26689
26	859	8690	8690 - 9039	814	26690	26690 - 27039
...						

Note: The channel numbers that designate carrier frequencies so close to the operating band edges that the carrier extends beyond the operating band edge shall not be used. This implies that the first 7, 15, 25, 50, 75 and 100 channel numbers at the lower operating band edge and the last 6, 14, 24, 49, 74 and 99 channel numbers at the upper operating band edge shall not be used for channel bandwidths of 1.4, 3, 5, 10, 15 and 20 MHz respectively.

### LTE TDD Channel Number Ranges

The carrier frequency in the uplink and downlink is designated by the E-UTRA Absolute Radio Frequency Channel Number (EARFCN) in the range 0 – 65535. The relation between EARFCN and the carrier frequency in MHz for the downlink is given by the following equation, where FDL\_low and NOffs-DL are given in table 5.4.4-1 and NDL is the downlink EARFCN.

$$FDL = FDL\_low + 0.1(NDL - NOffs-DL)$$

The relation between EARFCN and the carrier frequency in MHz for the uplink is given by the following equation where FUL\_low and NOffs-UL are given in table 5.4.4-1 and NUL is the uplink EARFCN.

$$FUL = FUL\_low + 0.1(NUL - NOffs-UL)$$

Band	Downlink		Uplink		
	NOffs-DL	Range of ND	FUL_low (MHz)	NOffs-UL	Range of NUL
33	1900	36000	36000 – 36199	1900	36000 – 36199
34	2010	36200	36200 – 36349	2010	36200 – 36349
35	1850	36350	36350 – 36949	1850	36350 – 36949
36	1930	36950	36950 – 37549	1930	36950 – 37549
37	1910	37550	37550 – 37749	1910	37550 – 37749
38	2570	37750	37750 – 38249	2570	37750 – 38249
39	1880	38250	38250 – 38649	1880	38250 – 38649
40	2300	38650	38650 – 39649	2300	38650 – 39649
41	2496	39650	39650 – 41589	2496	39650 – 41589
42	3400	41590	41590 – 43589	3400	41590 – 43589
43	3600	43590	43590 – 45589	3600	43590 – 45589

Note: The channel numbers that designate carrier frequencies so close to the operating band edges that the carrier extends beyond the operating band edge shall not be used. This implies that the first 7, 15, 25, 50, 75 and 100 channel numbers at the lower operating band edge and the last 6, 14, 24, 49, 74 and 99 channel numbers at the upper operating band edge shall not be used for channel bandwidths of 1.4, 3, 5, 10, 15 and 20 MHz respectively.

## TDSCDMA Channel Number Ranges

### 1.28 Mcps TDD Option

No TX-RX frequency separation is required as Time Division Duplex (TDD) is employed. Each subframe consists of 7 main timeslots where all main timeslots (at least the first one) before the single switching point are allocated DL and all main timeslots (at least the last one) after the single switching point are allocated UL.

The nominal channel spacing is 1.6 MHz, but this can be adjusted to optimise performance in a particular deployment scenario.

The carrier frequency is designated by the UTRA absolute radio frequency channel number (UARFCN). The value of the UARFCN in the IMT2000 band is defined in the general case as follows:

$$N_t = 5 * F \quad 0.0 \text{ MHz} \leq F \leq 3276.6 \text{ MHz}$$

where F is the carrier frequency in MHz

Additional channels applicable to operation in the frequency band defined in sub-clause 5.2(d) are defined via the following UARFCN definition:

$$N_t = 5 * (F - 2150.1 \text{ MHz}) / 2572.5 \text{ MHz} \leq F \leq 2617.5 \text{ MHz}$$

UARFCN

1.28 Mcps TDD Option

The following UARFCN range shall be supported for each band:

**Table: UTRA Absolute Radio  
Frequency Channel Number 1.28  
Mcps TDD Option**

Frequency Band	Frequency Range	UARFCN Uplink and Downlink transmission
For operation in frequency band as defined in subclause 5.2 (a)	1900–1920 MHz	9504 to 9596
	2010–2025 MHz	10054 to 10121
For operation in frequency band as defined in subclause 5.2 (b)	1850–1910 MHz	9254 to 9546
	1930–1990 MHz	9654 to 9946
For operation in frequency band as defined in subclause 5.2 (c)	1910–1930 MHz	9554 to 9646
For operation in frequency band as defined in subclause 5.2 (d)	2570–2620 MHz	12854 to 13096
For operation in frequency band as defined in subclause 5.2 (e)	2300–2400 MHz	11504 to 11996
For operation in frequency band as defined in subclause 5.2 (f)	1880–1920 MHz	9404 to 9596

## Radio Setup

Allows access to the sub-menus for selecting the radio standard and associated radio band. You can also set a frequency reference and offset.

This menu is greyed out when on E6630A. Radio band settings for GSM, cdma2000, and so on -- most of which are not actually supported in E6630A, which has three narrow frequency bands. So band settings are grayed out.

Key Path	Source, Frequency
Initial S/W Revision	A.05.00

## Radio Standard

Allows access to the channel band sub-menus to select the desired radio standard. When you have selected the radio standard, you can then set an active channel band. The radio standard and the active

channel band allow you to use channel numbers to set frequency automatically.

<b>Key Path</b>	Source, Frequency, Radio Setup
<b>Remote Command</b>	:SOURce:FREQuency:CHANnels:BAND NONE   PGSM   EGSM   RGSM   DCS1800   PCS1900   TGSM810   GSM450   GSM480   GSM700   GSM850   BANDI   BANDII   BANDIII   BANDIV   BANDV   BANDVI   BANDVII   BANDVIII   BANDIX   BANDX   BANDXI   BANDXII   BANDXIII   BANDXIV   BANDXIX   USCELL   USPCS   JAPAN   KOREAN   NMT   IMT2K   UPPER   SECOND   PAMR400   PAMR800   IMTEXT   PCS1DOT9G   AWS   US2DOT5G   PUBLIC   LOWER   BAND1   BAND2   BAND3   BAND4   BAND5   BAND6   BAND7   BAND8   BAND10   BAND11   BAND12   BAND13   BAND14   BAND17   BAND18   BAND19   BAND20   BAND21   BAND24   BAND25   BAND26   BAND27   BAND28   BAND29   BAND30   BAND31   BAND33   BAND34   BAND35   BAND36   BAND37   BAND38   BAND39   BAND40   BAND41   BAND42   BAND43   BAND44   BANDA   BANDB   BANDC   BANDD   BANDE   BANDE :SOURce:FREQuency:CHANnels:BAND?
<b>Example</b>	:SOUR:FREQ:CHAN:BAND PGSM
<b>Notes</b>	Set this setting to "NONE" will grey out "Channel" on page 1384 Channel
<b>Initial S/W Revision</b>	A.05.00

#### None

Selects no radio standard for use. When you have selected the radio standard to NONE, you cannot use channel numbers to set frequency automatically. You will need to set the frequency manually.

<b>Key Path</b>	Source, Frequency, Radio Setup, Radio Standard
<b>Initial S/W Revision</b>	A.05.00

#### GSM/EDGE

Sets GSM/EDGE as the radio standard for use and accesses the GSM/EDGE specific channel band sub-menus.

<b>Key Path</b>	Source, Frequency, Radio Setup, Radio Standard
<b>Initial S/W Revision</b>	A.05.00

#### P-GSM

Selects P-GSM as the active channel band.

<b>Key Path</b>	Source, Frequency, Radio Setup, Radio Standard, GSM/EDGE
<b>Example</b>	:SOUR:FREQ:CHAN:BAND PGSM
<b>Initial S/W Revision</b>	A.05.00

**E-GSM**

Selects E-GSM as the active channel band.

Key Path	Source, Frequency, Radio Setup, Radio Standard, GSM/EDGE
<b>Example</b>	:SOUR:FREQ:CHAN:BAND EGSM
Initial S/W Revision	A.05.00

**R-GSM**

Selects R-GSM as the active channel band.

Key Path	Source, Frequency, Radio Setup, Radio Standard, GSM/EDGE
<b>Example</b>	:SOUR:FREQ:CHAN:BAND RGSM
Initial S/W Revision	A.05.00

**DCS 1800**

Selects DCS 1800 as the active channel band.

Key Path	Source, Frequency, Radio Setup, Radio Standard, GSM/EDGE
<b>Example</b>	:SOUR:FREQ:CHAN:BAND DCS1800
Initial S/W Revision	A.05.00

**PCS 1900**

Selects PCS 1900 as the active channel band.

Key Path	Source, Frequency, Radio Setup, Radio Standard, GSM/EDGE
<b>Example</b>	:SOUR:FREQ:CHAN:BAND PCS1900
Initial S/W Revision	A.05.00

**GSM 450**

Selects GSM 450 as the active channel band.

Key Path	Source, Frequency, Radio Setup, Radio Standard, GSM/EDGE
<b>Example</b>	:SOUR:FREQ:CHAN:BAND GSM450
Initial S/W Revision	A.05.00

### GSM 480

Selects GSM 480 as the active channel band.

Key Path	Source, Frequency, Radio Setup, Radio Standard, GSM/EDGE
<b>Example</b>	:SOUR:FREQ:CHAN:BAND GSM480
Initial S/W Revision	A.05.00

### GSM 850

Selects GSM 850 as the active channel band.

Key Path	Source, Frequency, Radio Setup, Radio Standard, GSM/EDGE
<b>Example</b>	:SOUR:FREQ:CHAN:BAND GSM850
Initial S/W Revision	A.05.00

### GSM 700

Selects GSM 700 as the active channel band.

Key Path	Source, Frequency, Radio Setup, Radio Standard, GSM/EDGE
<b>Example</b>	:SOUR:FREQ:CHAN:BAND GSM700
Initial S/W Revision	A.05.00

### T-GSM 810

Selects T-GSM 810 as the active channel band.

Key Path	Source, Frequency, Radio Setup, Radio Standard, GSM/EDGE
<b>Example</b>	:SOUR:FREQ:CHAN:BAND T-GSM810
Initial S/W Revision	A.05.00

### WCDMA

Sets WCDMA as the radio standard for use and accesses the W-CDMA specific channel band sub-menus.

Key Path	Source, Frequency, Radio Setup, Radio Standard
Initial S/W Revision	A.05.00

### Band I

Selects Band I as the active channel band.

Key Path	Source, Frequency, Radio Setup, Radio Standard, WCDMA
<b>Example</b>	:SOUR:FREQ:CHAN:BAND BANDI
Initial S/W Revision	A.05.00

**Band II**

Selects Band II as the active channel band.

Key Path	Source, Frequency, Radio Setup, Radio Standard, WCDMA
<b>Example</b>	:SOUR:FREQ:CHAN:BAND BANDII
Initial S/W Revision	A.05.00

**Band III**

Selects Band III as the active channel band.

Key Path	Source, Frequency, Radio Setup, Radio Standard, WCDMA
<b>Example</b>	:SOUR:FREQ:CHAN:BAND BANDIII
Initial S/W Revision	A.05.00

**Band IV**

Selects Band IV as the active channel band.

Key Path	Source, Frequency, Radio Setup, Radio Standard, WCDMA
<b>Example</b>	:SOUR:FREQ:CHAN:BAND BANDIV
Initial S/W Revision	A.05.00

**Band V**

Selects Band V as the active channel band.

Key Path	Source, Frequency, Radio Setup, Radio Standard, WCDMA
<b>Example</b>	:SOUR:FREQ:CHAN:BAND BANDV
Initial S/W Revision	A.05.00

**Band VI**

Selects Band VI as the active channel band.

---

Key Path	Source, Frequency, Radio Setup, Radio Standard, WCDMA
<b>Example</b>	:SOUR:FREQ:CHAN:BAND BANDVI
Initial S/W Revision	A.05.00

---

#### Band VII

Selects Band VII as the active channel band.

---

Key Path	Source, Frequency, Radio Setup, Radio Standard, WCDMA
<b>Example</b>	:SOUR:FREQ:CHAN:BAND BANDVII
Initial S/W Revision	A.05.00

---

#### Band VIII

Selects Band VIII as the active channel band.

---

Key Path	Source, Frequency, Radio Setup, Radio Standard, WCDMA
<b>Example</b>	:SOUR:FREQ:CHAN:BAND BANDVIII
Initial S/W Revision	A.05.00

---

#### Band IX

Selects Band IX as the active channel band.

---

Key Path	Source, Frequency, Radio Setup, Radio Standard, WCDMA
<b>Example</b>	:SOUR:FREQ:CHAN:BAND BANDIX
Initial S/W Revision	A.05.00

---

#### Band X

Selects Band X as the active channel band.

---

Key Path	Source, Frequency, Radio Setup, Radio Standard, WCDMA
<b>Example</b>	:SOUR:FREQ:CHAN:BAND BANDX
Initial S/W Revision	A.05.00

---

#### Band XI

Selects Band XI as the active channel band.



Key Path	Source, Frequency, Radio Setup, Radio Standard, WCDMA
<b>Example</b>	:SOUR:FREQ:CHAN:BAND BANDXI
Initial S/W Revision	A.05.00

**Band XII**

Selects Band XII as the active channel band.

Key Path	Source, Frequency, Radio Setup, Radio Standard, WCDMA
<b>Example</b>	:SOUR:FREQ:CHAN:BAND BANDXII
Initial S/W Revision	A.05.00

**Band XIII**

Selects band XIII as the active channel band.

Key Path	Source, Frequency, Radio Setup, Radio Standard, WCDMA
<b>Example</b>	:SOUR:FREQ:CHAN:BAND BANDXIII
Initial S/W Revision	A.05.00

**Band XIV**

Selects Band XIV as the active channel band.

Key Path	Source, Frequency, Radio Setup, Radio Standard, WCDMA
<b>Example</b>	:SOUR:FREQ:CHAN:BAND BANDXIV
Initial S/W Revision	A.05.00

**LTE**

Sets LTE FDD as the radio standard for use and accesses the LTE FDD specific channel band sub-menus..

Key Path	Source, Frequency, Radio Setup, Radio Standard
Initial S/W Revision	A.09.50

**BAND 1**

Selects BAND 1 as the band for the current step.

Key Path	Source, Frequency, Radio Setup, Radio Standard, LTE
----------	-----------------------------------------------------

---

<b>Example</b>	:SOUR:FREQ:CHAN:BAND BAND1
Initial S/W Revision	A.09.50

---

#### BAND 2

Selects BAND 2 as the band for the current step.

---

Key Path	Source, Frequency, Radio Setup, Radio Standard, LTE
<b>Example</b>	:SOUR:FREQ:CHAN:BAND BAND2
Initial S/W Revision	A.09.50

---

#### BAND 3

Selects BAND 3 as the band for the current step.

---

Key Path	Source, Frequency, Radio Setup, Radio Standard, LTE
<b>Example</b>	:SOUR:FREQ:CHAN:BAND BAND3
Initial S/W Revision	A.09.50

---

#### BAND 4

Selects BAND 4 as the band for the current step.

---

Key Path	Source, Frequency, Radio Setup, Radio Standard, LTE
<b>Example</b>	:SOUR:FREQ:CHAN:BAND BAND4
Initial S/W Revision	A.09.50

---

#### BAND 5

Selects BAND 5 as the band for the current step.

---

Key Path	Source, Frequency, Radio Setup, Radio Standard, LTE
<b>Example</b>	:SOUR:FREQ:CHAN:BAND BAND5
Initial S/W Revision	A.09.50

---

#### BAND 6

Selects BAND 6 as the band for the current step.

---

Key Path	Source, Frequency, Radio Setup, Radio Standard, LTE
----------	-----------------------------------------------------

---

<b>Example</b>	:SOUR:FREQ:CHAN:BAND BAND6
Initial S/W Revision	A.09.50

**BAND 7**

Selects BAND 7 as the band for the current step.

Key Path	Source, Frequency, Radio Setup, Radio Standard, LTE
<b>Example</b>	:SOUR:FREQ:CHAN:BAND BAND7
Initial S/W Revision	A.09.50

**BAND 8**

Selects BAND 8 as the band for the current step.

Key Path	Source, Frequency, Radio Setup, Radio Standard, LTE
<b>Example</b>	:SOUR:FREQ:CHAN:BAND BAND8
Initial S/W Revision	A.09.50

**BAND 9**

Selects BAND 9 as the band for the current step.

Key Path	Source, Frequency, Radio Setup, Radio Standard, LTE
<b>Example</b>	:SOUR:FREQ:CHAN:BAND BAND9
Initial S/W Revision	A.09.50

**BAND 10**

Selects BAND 10 as the band for the current step.

Key Path	Source, Frequency, Radio Setup, Radio Standard, LTE
<b>Example</b>	:SOUR:FREQ:CHAN:BAND BAND10
Initial S/W Revision	A.09.50

**BAND 11**

Selects BAND 11 as the band for the current step.

Key Path	Source, Frequency, Radio Setup, Radio Standard, LTE
----------	-----------------------------------------------------

---

<b>Example</b>	:SOUR:FREQ:CHAN:BAND BAND11
Initial S/W Revision	A.09.50

---

#### BAND 12

Selects BAND 12 as the band for the current step.

---

Key Path	Source, Frequency, Radio Setup, Radio Standard, LTE
<b>Example</b>	:SOUR:FREQ:CHAN:BAND BAND12
Initial S/W Revision	A.09.50

---

#### BAND 13

Selects BAND 13 as the band for the current step.

---

Key Path	Source, Frequency, Radio Setup, Radio Standard, LTE
<b>Example</b>	:SOUR:FREQ:CHAN:BAND BAND13
Initial S/W Revision	A.09.50

---

#### BAND 14

Selects BAND 14 as the band for the current step.

---

Key Path	Source, Frequency, Radio Setup, Radio Standard, LTE
<b>Example</b>	:SOUR:FREQ:CHAN:BAND BAND14
Initial S/W Revision	A.09.50

---

#### BAND 17

Selects BAND 17 as the band for the current step.

---

Key Path	Source, Frequency, Radio Setup, Radio Standard, LTE
<b>Example</b>	:SOUR:FREQ:CHAN:BAND BAND17
Initial S/W Revision	A.09.50

---

#### BAND 18

Selects BAND 18 as the band for the current step.

---

Key Path	Source, Frequency, Radio Setup, Radio Standard, LTE
----------	-----------------------------------------------------

---

<b>Example</b>	:SOUR:FREQ:CHAN:BAND BAND18
Initial S/W Revision	A.09.50

**BAND 19**

Selects BAND 19 as the band for the current step.

Key Path	Source, Frequency, Radio Setup, Radio Standard, LTE
<b>Example</b>	:SOUR:FREQ:CHAN:BAND BAND19
Initial S/W Revision	A.09.50

**BAND 20**

Selects BAND 20 as the band for the current step.

Key Path	Source, Frequency, Radio Setup, Radio Standard, LTE
<b>Example</b>	:SOUR:FREQ:CHAN:BAND BAND20
Initial S/W Revision	A.09.50

**BAND 21**

Selects BAND 21 as the band for the current step.

Key Path	Source, Frequency, Radio Setup, Radio Standard, LTE
<b>Example</b>	:SOUR:FREQ:CHAN:BAND BAND21
Initial S/W Revision	A.09.50

**BAND 24**

Selects BAND 24 as the band for the current step.

Key Path	Source, Frequency, Radio Setup, Radio Standard, LTE
<b>Example</b>	:SOUR:FREQ:CHAN:BAND BAND24
Initial S/W Revision	A.09.50

**BAND 25**

Selects BAND 25 as the band for the current step.

Key Path	Source, Frequency, Radio Setup, Radio Standard, LTE
----------	-----------------------------------------------------

---

<b>Example</b>	:SOUR:FREQ:CHAN:BAND BAND25
Initial S/W Revision	A.09.50

---

#### BAND 26

Selects BAND 26 as the band for the current step.

---

Key Path	Source, Frequency, Radio Setup, Radio Standard, LTE
<b>Example</b>	:SOUR:FREQ:CHAN:BAND BAND26
Initial S/W Revision	A.12.53

---

#### BAND 27

Selects BAND 27 as the band for the current step.

---

Key Path	Source, Frequency, Radio Setup, Radio Standard, LTE
<b>Example</b>	:SOUR:FREQ:CHAN:BAND BAND27
Initial S/W Revision	A.14.00

---

#### BAND 28

Selects BAND 28 as the band for the current step.

---

Key Path	Source, Frequency, Radio Setup, Radio Standard, LTE
<b>Example</b>	:SOUR:FREQ:CHAN:BAND BAND28
Initial S/W Revision	A.14.00

---

#### BAND 31

Selects BAND 31 as the band for the current step.

---

Key Path	Source, Frequency, Radio Setup, Radio Standard, LTE
<b>Example</b>	:SOUR:FREQ:CHAN:BAND BAND31
Initial S/W Revision	A.14.00

---

#### LTE TDD

Sets LTE TDD as the radio standard for use and accesses the LTE TDD specific channel band sub-menus..

---

Key Path	Source, Frequency, Radio Setup, Radio Standard
Initial S/W Revision	A.11.50

---

**BAND 33**

Selects BAND 33 as the band for the current step.

Key Path	Source, Frequency, Radio Setup, Radio Standard, LTE TDD
<b>Example</b>	:SOUR:FREQ:CHAN:BAND BAND33
Initial S/W Revision	A.11.50

**BAND 34**

Selects BAND 34 as the band for the current step.

Key Path	Source, Frequency, Radio Setup, Radio Standard, LTE TDD
<b>Example</b>	:SOUR:FREQ:CHAN:BAND BAND34
Initial S/W Revision	A.11.50

**BAND 35**

Selects BAND 35 as the band for the current step.

Key Path	Source, Frequency, Radio Setup, Radio Standard, LTE TDD
<b>Example</b>	:SOUR:FREQ:CHAN:BAND BAND35
Initial S/W Revision	A.11.50

**BAND 36**

Selects BAND 36 as the band for the current step.

Key Path	Source, Frequency, Radio Setup, Radio Standard, LTE TDD
<b>Example</b>	:SOUR:FREQ:CHAN:BAND BAND36
Initial S/W Revision	A.11.50

**BAND 37**

Selects BAND 37 as the band for the current step.

Key Path	Source, Frequency, Radio Setup, Radio Standard, LTE TDD
<b>Example</b>	:SOUR:FREQ:CHAN:BAND BAND37
Initial S/W Revision	A.11.50

### BAND 38

Selects BAND 38 as the band for the current step.

Key Path	Source, Frequency, Radio Setup, Radio Standard, LTE TDD
<b>Example</b>	:SOUR:FREQ:CHAN:BAND BAND38
Initial S/W Revision	A.11.50

### BAND 39

Selects BAND 39 as the band for the current step.

Key Path	Source, Frequency, Radio Setup, Radio Standard, LTE TDD
<b>Example</b>	:SOUR:FREQ:CHAN:BAND BAND39
Initial S/W Revision	A.11.50

### BAND 40

Selects BAND 40 as the band for the current step.

Key Path	Source, Frequency, Radio Setup, Radio Standard, LTE TDD
<b>Example</b>	:SOUR:FREQ:CHAN:BAND BAND40
Initial S/W Revision	A.11.50

### BAND 41

Selects BAND 41 as the band for the current step.

Key Path	Source, Frequency, Radio Setup, Radio Standard, LTE TDD
<b>Example</b>	:SOUR:FREQ:CHAN:BAND BAND41
Initial S/W Revision	A.11.50

### BAND 42

Selects BAND 42 as the band for the current step.

Key Path	Source, Frequency, Radio Setup, Radio Standard, LTE TDD
<b>Example</b>	:SOUR:FREQ:CHAN:BAND BAND42
Initial S/W Revision	A.11.50



**BAND 43**

Selects BAND 43 as the band for the current step.

Key Path	Source, Frequency, Radio Setup, Radio Standard, LTE TDD
<b>Example</b>	:SOUR:FREQ:CHAN:BAND BAND43
Initial S/W Revision	A.11.50

**BAND 44**

Selects BAND 44 as the band for the current step.

Key Path	Source, Frequency, Radio Setup, Radio Standard, LTE TDD
<b>Example</b>	:SOUR:FREQ:CHAN:BAND BAND44
Initial S/W Revision	A.14.00

**TDSCDMA**

Sets TDSCDMA as the radio standard for use and accesses the TDSCDMA specific channel band sub-menus..

Key Path	Source, Frequency, Radio Setup, Radio Standard
Initial S/W Revision	A.11.50

**BAND A**

Selects BAND A as the band for the current step.

Key Path	Source, Frequency, Radio Setup, Radio Standard, TDSCDMA
<b>Example</b>	:SOUR:FREQ:CHAN:BAND BANDA
Initial S/W Revision	A.11.50

**BAND B**

Selects BAND B as the band for the current step.

Key Path	Source, Frequency, Radio Setup, Radio Standard, TDSCDMA
<b>Example</b>	:SOUR:FREQ:CHAN:BAND BANDB
Initial S/W Revision	A.11.50

**BAND C**

Selects BAND C as the band for the current step.

Key Path	Source, Frequency, Radio Setup, Radio Standard, TDSCDMA
<b>Example</b>	:SOUR:FREQ:CHAN:BAND BANDC
Initial S/W Revision	A.11.50

#### BAND D

Selects BAND D as the band for the current step.

Key Path	Source, Frequency, Radio Setup, Radio Standard, TDSCDMA
<b>Example</b>	:SOUR:FREQ:CHAN:BAND BANDD
Initial S/W Revision	A.11.50

#### BAND E

Selects BAND E as the band for the current step.

Key Path	Source, Frequency, Radio Setup, Radio Standard, TDSCDMA
<b>Example</b>	:SOUR:FREQ:CHAN:BAND BANDE
Initial S/W Revision	A.11.50

#### BAND F

Selects BAND F as the band for the current step.

Key Path	Source, Frequency, Radio Setup, Radio Standard, TDSCDMA
<b>Example</b>	:SOUR:FREQ:CHAN:BAND BANDF
Initial S/W Revision	A.11.50

#### Radio Band Link

Allows you to specify the channel band type as either uplink or downlink link direction. This value is used in conjunction with the channel band and channel number to determine the absolute frequency output by the source. When set to “Uplink”, the source will calculate the uplink frequency using an uplink formula together with the selected channel band and channel number . When set to “Downlink”, the source will calculate the downlink frequency using a downlink formula together with the selected channel band and channel number.

Key Path	Source, Frequency, Radio Setup
<b>Remote Command</b>	:SOURce:RADio:BAND:LINK DOWN UP :SOURce:RADio:BAND:LINK?

<b>Example</b>	:SOUR:RAD:BAND:LINK UP
Preset	DOWN
Range	DOWN   UP
<b>Backwards Compatibility SCPI</b>	:SOURce:RADio:DEVIce BTS MS
	:SOURce:RADio:DEVIce?
Backwards Compatibility Notes	BTS maps to the Downlink frequency MS maps to the Uplink frequency
Initial S/W Revision	A.05.00

## Set Reference Frequency

This key allows you to set the frequency reference. Pressing this key turns the frequency reference state to ON, sets the reference frequency value to the current frequency, maintains this frequency at the RF output, and sets the displayed frequency to 0.00 Hz. All subsequent frequencies entered under Source>Frequency>Frequency are interpreted as being relative to this reference frequency.

When you use a frequency reference, the signal generator outputs a frequency that is set relative to the reference frequency by the value entered under Source>Frequency>Frequency as follows:

Output frequency = reference frequency - entered frequency

Where:

reference frequency equals the original RF frequency entered under Source>Frequency>Frequency and set as the reference frequency

entered frequency equals a new value entered under Source>Frequency>Frequency

In addition, the displayed frequency value will be the same as the value entered under Source>Frequency>Frequency.

### NOTE

If Freq Reference is set to ON with a reference value set, entering a value under Source>Frequency>Frequency and pressing Set Frequency Reference will add that value to the existing Freq Reference value.

If you wish to change the reference frequency value to the new value entered under Source>Frequency>Frequency, first you must set Freq Reference to OFF and then press Set Frequency Reference.

Key Path	Source, Frequency
<b>Remote Command</b>	:SOURce:FREQuency:REFerence:SET
<b>Example</b>	:SOUR:FREQ:REF:SET
Dependencies	This setting is unavailable, and is grayed out when the List Sequencer is turned ON.
Initial S/W Revision	A.05.00

## Freq Reference

This key allows you to toggle the state of the frequency reference. When the frequency reference state is ON, an annunciator is displayed on the main source view to indicate this state to the user.

When you use a frequency reference, the signal generator outputs a frequency that is set relative to the reference frequency by the value entered under Source>Frequency>Frequency as follows:

Output frequency = reference frequency + entered frequency

Where:

reference frequency equals the original RF frequency entered under Source>Frequency>Frequency and set as the reference frequency

entered frequency equals a new value entered under Source>Frequency>Frequency

For more information on Reference Frequency refer to ["Set Reference Frequency" on page 1408](#)

Key Path	Source, Frequency
<b>Remote Command</b>	:SOURce:FREQuency:REFerence <freq> :SOURce:FREQuency:REFerence? :SOURce:FREQuency:REFerence:STATe OFF ON 0 1 :SOURce:FREQuency:REFerence:STATe?
<b>Example</b>	:SOUR:FREQ:REF 0.00 Hz :SOUR:FREQ:REF:STATe ON
<b>Dependencies</b>	This setting is unavailable, and is grayed out when the List Sequencer is turned ON.
<b>Couplings</b>	The frequency reference state is coupled to the frequency reference set immediate action. When the reference set immediate action key is pressed, or the SCPI command issued, it turns the frequency reference state ON.
<b>Preset</b>	0.00 Hz OFF
<b>Min</b>	0.00 Hz
<b>Max</b>	Hardware Dependant: Option 503 = 3.6 GHz Option 504 = 3.8 GHz Option 506 = 6.00 GHz
<b>Initial S/W Revision</b>	A.05.00

## Freq Offset

Allows you to specify the frequency offset value. When the frequency offset state is ON, an annunciator is displayed on the main source view to indicate this state to the user.

When the frequency offset is set to zero (0) and you set a new offset value, the displayed frequency value will change as follows and the RF output frequency will not change:

Displayed value = output frequency + offset value

Where:

output frequency equals the original frequency entered under Source>Frequency>Frequency

offset value equals the value entered under Source>Frequency>Freq Offset

When the frequency offset is set to a value other than zero (0) and you enter a new frequency value under Source>Frequency>Frequency, the displayed frequency will be the same as the value entered and the RF output frequency will be equal to the value entered minus the offset value as follows:

Output frequency = entered frequency – offset frequency

Displayed frequency = output frequency + offset frequency

Displayed frequency = entered frequency

Where:

entered frequency equals the frequency entered under Source>Frequency>Frequency

offset frequency equals the value previously entered and set under Source>Frequency>Freq Offset

Key Path	Source, Frequency
<b>Remote Command</b>	:SOURce:FREQuency:OFFSet <freq> :SOURce:FREQuency:OFFSet?
<b>Example</b>	:SOUR:FREQ:OFFS 0 Hz
Dependencies	This setting is unavailable, and is grayed out when the List Sequencer is turned ON.
Preset	0 Hz
Min	-100.00 GHz
Max	100.00 GHz
Initial S/W Revision	A.05.00

## Modulation Setup

Allows access to the menus for setting up the available modulation types: "ARB" on page 1424, "AM" on page 1445, "FM" on page 1446, and "PM" on page 1448.

Key Path	Source
Initial S/W Revision	A.05.00

## ARB

Allows you access to the ARB sub-menus.

Key Path	Source, Modulation Setup
Initial S/W Revision	A.05.00

## ARB

Allows you to toggle the state of the ARB function. When the ARB is On, a “MOD” annunciator is displayed in the system settings panel. When the ARB is turned Off, the MOD annunciator is cleared

Key Path	Source, Modulation Setup, ARB
Remote Command	:SOURce:RADio:ARB[:STATe] ON OFF 1 0 :SOURce:RADio:ARB[:STATe]?
Example	:SOUR:RAD:ARB OFF :SOUR:RAD:ARB?
Notes	If the ARB is ON, a user then loads or deletes another file to ARB memory, the playing waveform segment may not keep phase continuity during the ARB memory operation. The waveform will be replayed after the ARB operation is finished.
Dependencies	This setting is for independent mode and has no effect on 3.3.8 list sequencer mode. Setting <b>"Sequencer" on page 1449</b> Sequencer to On will put source enter list sequencer mode, and even if ARB state is On, the ARB file will not be played. Setting <b>"Sequencer" on page 1449</b> Sequencer to Off will make source leave list sequencer mode, and this setting will take effect immediately. The ARB can only be turned on when there is a waveform file selected for playback. On the GUI if no waveform is selected, this key is grayed out. If you send the SCPI command to turn the ARB on with no waveform selected for playback, the ARB state remains OFF and an error is generated. "- When you try to recall a certain set of states in which the selected waveform is not in ARB memory and the ARB state is On, errors are reported
Preset	Off
Range	On   Off
Initial S/W Revision	A.05.00

## Select Waveform

Allows you to access to the waveform selection sub-menus.

Pressing this key changes the central view area to show the Waveform File Selection view.

Key Path	Source, Modulation Setup, ARB
Initial S/W Revision	A.05.00

## Select Waveform

Allows you to select a waveform sequence or segment for the dual ARB to play.

NOTE: Selecting a waveform file does not result in automatic adjustments to burst timing (to compensate for the presence or absence of a Multiport Adapter); that adjustment occurs only when a waveform is loaded to ARB memory. See "Load Segment to ARB Memory" for more information about this adjustment.

Key Path	Source, Modulation Setup, ARB, Select Waveform
Remote Command	:SOURce:RADio:ARB:WAVeform <string> :SOURce:RADio:ARB:WAVeform?
Example	:SOUR:RAD:ARB:WAV "test_waveform.bin"
Notes	<p>If intended waveform is not in the memory yet, then issuing this command by SCPI will invoke ARB loading operation first, which involves a delay of unpredictable length. So this command should be followed by the query *OPC?, which holds off subsequent commands until the loading operation is complete.</p> <p>&lt;string&gt; - specifies the name of the waveform segment or waveform sequence to be played by the ARB.</p> <p>When in Sequence Analyzer mode, and Include Source is Yes, if the you attempt to play a waveform sequence but not all the required waveform segments are in the ARB playback memory, the application will reject the loading operation with an error is generated .</p> <p>When Include Source is No, if you attempt to play a waveform sequence but not all the required waveform segments are contained in the ARB playback memory, the application will attempt to load the required segments from either the default directory of the current directory. If the ARB memory does not have enough space for all the waveform segments to be loaded, an error is generated and none of the waveform segments is loaded.</p> <p>If the ARB is ON, and you attempt to play a waveform sequence but not all the waveform segments within the sequence could be found to be loaded into ARB memory, an error is generated. The selected waveform keeps the previous value and ARB state remains On.</p> <p>If you specify a waveform segment over SCPI but the waveform segment is not present within ARB playback memory and cannot be found for auto loading within the current directory or the default directory, an error is generated and the file selection remains unchanged.</p> <p>If you select a waveform for playback and the waveform requires a license that is not installed on the instrument, an error is generated. error is generated.</p> <p>If the ARB is ON and you load a file to ARB memory or delete a file from ARB memory, the playing waveform segment may not keep phase continuity during the ARB memory operation. The waveform will be replayed after the ARB operation is finished.</p>
Initial S/W Revision	A.05.00

### Segments on Hard Disk

Allows you access to the sub-menus for loading waveform segments from the hard disk into ARB memory. The default directory is: D: varb.

Pressing this key changes the current view to the Waveform Management View.

Key Path	Source, Modulation Setup, ARB, Select Waveform
Initial S/W Revision	A.05.00

### Load Segment To ARB Memory

Allows you to load the selected file into ARB memory. On the front panel you select the file for loading to the ARB memory by highlighting the desired file in the list. Using the SCPI command, you specify the file

name on the HDD.

“NVWFM” (none-volatile storage) MSUS (Mass Storage Unit Specifier) is supported in the memory subsystem because the ARB memory cannot be accessed directly. Therefore, files must be downloaded to the instrument hard disk and then loaded into the ARB memory. “NVWFM” MSUS will be mapped to the default directory D: VARB. The SCPI command supports using either “NVWFM” MSUS or specifying a full path. For more information, see Memory Subsystem (Remote Command Only).

If a file of the same name already exists within ARB memory, it is overwritten. If you wish to load two segments of the same name, you must rename one of the segments before loading it into ARB memory. To rename a segment, you can either use Windows File Explorer, or the :MMEMORY:COPY command.

NOTE: When a waveform file is loaded to ARB memory, burst timing adjustments are made automatically, based on whether or not a Multiport Adapter is connected to the test set and powered on. If the connection/power status of the Multiport Adapter is changed after a waveform file has been loaded, it needs to be loaded again.

<b>Key Path</b>	Source, Modulation Setup, ARB, Select Waveform, Segments on Hard Disk
<b>Remote Command</b>	:SOURCE:RADio:ARB:LOAD <string>
<b>Example</b>	:SOUR:RAD:ARB:LOAD "D: VARB\testwaveform.bin" or :SOUR:RAD:ARB:LOAD "NVWFM:testwaveform.bin"
<b>Notes</b>	<p>Because loading the file involves a delay of unpredictable length, this command should be followed by the query *OPC?, which holds off subsequent commands until the loading operating is complete.</p> <p>&lt;string&gt; - specifies the path name of the file to load from the HDD into ARB memory. It could be a &lt;full path + filename&gt;, or &lt;"NVWFM" MSUS + colon + filename&gt;.</p> <p>When in Sequence Analyzer mode, and Include Source is Yes, an attempt to load a file to ARB memory will be rejected with an error.</p> <p>When Include Source is No and if there is insufficient free ARB memory to load the selected waveform, an error is generated. .</p> <p>If you specify a file over SCPI, but the file is not at the specified location, an error is generated.</p> <p>If you try to load a waveform file but the file contains less than 500 IQ samples, an error is generated.</p> <p>If you try to load a Signal Studio waveform "*.wfm" which contains invalid waveform header, an error is generated.</p> <p>If the ARB is ON when you load a file to ARB memory or delete a file from ARB memory, the playing waveform segment may not keep phase continuity during the ARB memory operation. The waveform will be replayed after the ARB operation is finished.</p> <p>ARB can be loaded into ARB memory even required licenses do not present on the instrument. In this case, a GUI only warning message -800, "Operation complete; Loaded &lt;filename&gt; successfully, but no license &lt;required licenses&gt; installed". User can install required licenses according to &lt;required licenses&gt; string to license it, or multi-pack license it.</p>
<b>Initial S/W Revision</b>	A.05.00

### Load All To ARB Memory

Allows you to load all the segment files within the currently selected directory into ARB memory. If a file of the same name already exists within ARB memory, it is overwritten. If you wish to load two segments of the



same name, you must rename one of the segments before loading it into ARB memory. To rename a segment, you can either use Windows File Explorer, or the :MEMORY:COPY command.

NOTE: When a waveform file is loaded to ARB memory, burst timing adjustments are made automatically, based on whether or not a Multiport Adapter is connected to the test set and powered on. If the connection/power status of the Multiport Adapter is changed after a waveform file has been loaded, it needs to be loaded again.

<b>Key Path</b>	Source, Modulation Setup, ARB, Select Waveform, Segments on Hard Disk
<b>Remote Command</b>	:SOURce:RADio:ARB:LOAD:ALL <string>
<b>Example</b>	:SOUR:RAD:ARB:LOAD:ALL "D: varb"
<b>Notes</b>	<p>&lt;string&gt; - specifies the directory on the HDD to load the files into ARB memory from.</p> <p>When in Sequence Analyzer mode, and Include Source is Yes, an attempt to load all files from a directory to ARB memory is rejected with an error.</p> <p>When Include Source is No and there is insufficient free ARB memory to load all the waveforms, when the ARB memory is full, the copy ceases, and an error is generated.</p> <p>If you specify a directory over SCPI, but the directory does not exist, an error is generated.</p> <p>If the ARB is ON, a user then loads or deletes file to ARB memory, the playing waveform segment may not keep phase continuity during the ARB memory operation. The waveform will be replayed after the ARB operation is finished.</p>
<b>Initial S/W Revision</b>	A.05.00

#### Change Directory...

Allows you to change the currently selected directory on the hard disk. Pressing this key opens a standard windows change directory dialog allowing you to select the new directory of interest.

The current directory is used for manually loading waveform segments into ARB memory for playback, and as a search location for waveform segments that are required to be loaded into ARB memory for playback of a waveform sequence or a list sequence.

<b>Key Path</b>	Source, Modulation Setup, ARB, Select Waveform, Segments on Hard Disk
<b>Notes</b>	No remote command, SCPI front panel only.
<b>Initial S/W Revision</b>	A.05.00

#### Default Directory...

Allows you to change the default directory. It is used as a search location for waveform segments that are required to be loaded into ARB memory for playback of a waveform sequence, and as a search location for selecting waveforms using SCPI.

<b>Key Path</b>	Source, Modulation Setup, ARB, Select Waveform, Segments on Hard Disk
<b>Remote Command</b>	:SOURce:RADio:ARB:DEFault:DIRectory <string> :SOURce:RADio:ARB: DEFault:DIRectory?
<b>Example</b>	:SOUR:RAD:ARB:DEF:DIR "D:\ArbFiles"

	:SOUR:RAD:ARB:DEF:DIR?
State Saved	Persistent, survives a power cycle and a preset but not saved in the instrument state
Initial S/W Revision	A.05.00

### Segments in ARB Memory

Allows you access to the sub-menus for managing the files within ARB memory.

Key Path	Source, Modulation Setup, ARB, Select Waveform
Initial S/W Revision	A.05.00

### Delete Segment From ARB Mem

Allows you to remove a segment from ARB playback memory.

Key Path	Source, Modulation Setup, ARB, Select Waveform, Segments in ARB Memory
<b>Remote Command</b>	:SOURce:RADio:ARB:DELeTe <string>
<b>Example</b>	:SOUR:RAD:ARB:DEL "testwaveform.bin"
Notes	<p>&lt;string&gt; - specifies the waveform to be deleted from the ARB playback memory.</p> <p>When in Sequence Analyzer mode and Include Source is Yes, an attempt to delete a file from ARB memory is rejected with an error.</p> <p>When Include Source is No and you specify a file that does not exist within ARB memory, an error is generated.</p> <p>It is possible to delete files from within the ARB memory when the ARB is ON. However, if you attempt to delete the file that is currently playing an error is generated.</p> <p>It is possible to delete a file from within the ARB memory when the sequencer state is ON and the file is not being used by the List Sequencer. If you attempt to delete a file which is being used by the list sequencer, an error is generated.</p> <p>When sequencer state is On, even if ARB state is On, the selected waveform will not be played. In this case, if the selected waveform is not used in List Sequence, it can be deleted and the ARB state is turned Off.</p> <p>If the ARB is ON and you load a file to ARB memory or delete a file from ARB memory, the playing waveform segment may not keep phase continuity during the ARB memory operation. The waveform will be replayed after the ARB operation is finished.</p>
Initial S/W Revision	A.05.00

### Delete All From ARB Memory

Allows you to remove all segments from ARB playback memory.

Key Path	Source, Modulation Setup, ARB, Select Waveform, Segments in ARB Memory
----------	------------------------------------------------------------------------

<b>Remote Command</b>	:SOURce:RADio:ARB:DELeTe:ALL
<b>Example</b>	:SOUR:RAD:ARB:DELeTe:ALL
<b>Notes</b>	<p>When in Sequence Analyzer mode and Include Source is Yes, an attempt to delete all files from ARB memory is rejected with an error.</p> <p>When Include Source is No and you attempt to delete all files from ARB memory when the ARB is currently playing a file, all files except the one playing are deleted and an error is generated.</p> <p>If you attempt to delete all files from ARB memory when there are waveform files used in "<a href="#">List Sequencer</a>" on page 1449 and "<a href="#">Sequencer</a>" on page 1449 state is ON, all files except the files currently being used in list sequencer are deleted, and an error is generated.</p> <p>If the ARB is ON and you load a file to ARB memory or delete a file from ARB memory, the playing waveform segment may not keep phase continuity during the ARB memory operation. The waveform will be replayed after the ARB operation is finished.</p>
<b>Initial S/W Revision</b>	A.05.00

## ARB Setup

Allows access to the ARB setup sub-menus.

<b>Key Path</b>	Source, Modulation Setup, ARB
<b>Initial S/W Revision</b>	A.05.00

## Sample Rate

Allows you to set the ARB waveform playback sample rate.

<b>Key Path</b>	Source, Modulation Setup, ARB, ARB Setup
<b>Remote Command</b>	:SOURce:RADio:ARB:SCLock:RATE <freq> :SOURce:RADio:ARB:SCLock:RATE?
<b>Example</b>	:SOUR:RAD:ARB:SCL:RATE 48.00 MHz
<b>Notes</b>	If there is a sample rate specified in the header of the waveform file, changing that sample rate is not recommended, as it may cause problems with burst timing.
<b>Dependencies</b>	When a new waveform is selected for playback the settings contained within the associated waveform header file are applied to the ARB. The sample rate is one of the values stored within the header file. If the newly selected waveform file has an associated header file, the sample rate is updated with the value from the header file. The sample rate will remain unchanged if the newly selected waveform does not have an associated header file.
<b>Preset</b>	125.00 MHz
<b>Min</b>	1.00 kHz
<b>Max</b>	125.00 MHz
<b>Initial S/W Revision</b>	A.05.00

### Run-Time Scaling

Allows you to adjust the run-time scaling value. The run-time scaling value is applied in real-time while the waveform is playing.

<b>Key Path</b>	Source, Modulation Setup, ARB, ARB Setup
<b>Remote Command</b>	:SOURce:RADio:ARB:RSCaling <real> :SOURce:RADio:ARB:RSCaling?
<b>Example</b>	:SOUR:RAD:ARB:RSC 100.00
<b>Notes</b>	This setting cannot be set in E6640A/M9420A. Grey out on menu and the value is fixed at 70.00%.
<b>Dependencies</b>	When a new waveform is selected for playback the settings contained within the associated waveform header file are applied to the ARB. The run-time scaling is one of the values stored within the header file. If the newly selected waveform file has an associated header file, the run-time scaling is updated with the value from the header file. The run-time scaling will remain unchanged if the newly selected waveform does not have an associated header file.
<b>Preset</b>	70.00 %
<b>Min</b>	1.00 %
<b>Max</b>	100.00 %
<b>Initial S/W Revision</b>	A.05.00

### Baseband Freq Offset

Allows you to adjust the value by which the baseband frequency is offset relative to the carrier.

<b>Key Path</b>	Source, Modulation Setup, ARB, ARB Setup
<b>Remote Command</b>	:SOURce:RADio:ARB:BASEband:FREQuency:OFFSet <freq> :SOURce:RADio:ARB:BASEband:FREQuency:OFFSet?
<b>Example</b>	:SOUR:RAD:ARB:BAS:FREQ:OFFS 0.00 Hz
<b>Dependencies</b>	When a new waveform is selected for playback the settings contained within the associated waveform header file are applied to the ARB. The baseband frequency offset is one of the values stored within the header file. If the newly selected waveform file has an associated header file, the baseband frequency offset is updated with the value from the header file. The baseband frequency offset will remain unchanged if the newly selected waveform does not have an associated header file.
<b>Preset</b>	0.00 Hz
<b>Min</b>	-50.00 MHz
<b>Max</b>	50.00 MHz
<b>Initial S/W Revision</b>	A.05.00

### Edit RMS

Allows you to edit or calculate current RMS of selected waveform.

Key Path	Source, Modulation Setup, ARB, ARB Setup
Initial S/W Revision	A.14.50

### Current RMS

Allows you to directly specify current RMS value used to playback currently selected waveform. Please note incorrect RMS value may cause inaccurate power output in E6640A/M9420A that is sensitive to RMS value.

This setting is also updated by RMS in waveform header or updated when invoking RMS calculation operation.

This setting can be saved to the header of currently selected waveform by invoking ["Save Setup To Header" on page 1445](#) "Save Setup To Header".

Key Path	Source, Modulation Setup, ARB, ARB Setup, Edit RMS
Remote Command	:SOURce:RADio:ARB:RMS <float> :SOURce:RADio:ARB:RMS?
Example	:SOUR:RAD:ARB:HEAD:RMS 0.7 :SOUR:RAD:ARB:HEAD:RMS?
Notes	Valid range is 0 to 1.414, values outside the range will be clipped to the closest boundary. Note this value does not affect <a href="#">"List Sequencer" on page 1449</a> Source List Sequencer that always uses RMS value resides in each ARB header. If want this value to take effect in list sequencer, use <a href="#">"Save Setup To Header" on page 1445</a> "Save Setup to Header" to save current RMS value to header first, then play the ARB in source list sequencer.
Dependencies	When a new waveform is selected for playback, this setting is updated by the RMS value defined in associated waveform header file. If selected waveform has no associated header file or header file does not specify RMS value, then instrument will try to calculate out one automatically. Calculating RMS can also update this setting.
Preset	0
Range	0 ~ 1.414
Initial S/W Revision	A.14.50

### RMS Calculation Mode

Allows you to specify the mode to calculate the current RMS.

Key Path	Source, Modulation Setup, ARB, ARB Setup, Edit RMS
Remote Command	:SOURce:RADio:ARB:RMS:CALCulation:MODE AUTO   M1   M2   M3   M4 :SOURce:RADio:ARB:RMS:CALCulation:MODE?
Example	:SOUR:RAD:ARB:RMS:CALC:MODE AUTO
Notes	If no waveform is selected, or selected waveform is waveform sequence, the key will grey out.

Preset	AUTO
Range	AUTO   M1   M2   M3   M4
Initial S/W Revision	A.14.50

### Auto

RMS will be calculated based on the whole sample range of current selected waveform.

Key Path	Source, Modulation Setup, ARB, ARB Setup, Edit RMS, Calculate RMS, RMS Calculation Mode
<b>Example</b>	:SOUR:RAD:ARB:RMS:CALC:MODE AUTO
Initial S/W Revision	A.14.50

### Marker 1

Selects marker 1 to designate sample range used for RMS calculation.

Key Path	Source, Modulation Setup, ARB, ARB Setup, Edit RMS, Calculate RMS, RMS Calculation Mode , Marker
<b>Example</b>	:SOUR:RAD:ARB:RMS:CALC:MODE M1
Initial S/W Revision	A.14.50

### Marker 2

Selects marker 2 to designate sample range used for RMS calculation.

Key Path	Source, Modulation Setup, ARB, ARB Setup, Edit RMS, Calculate RMS, RMS Calculation Mode , Marker
<b>Example</b>	:SOUR:RAD:ARB:RMS:CALC:MODE M2
Initial S/W Revision	A.14.50

### Marker 3

Selects marker 3 to designate sample range used for RMS calculation.

Key Path	Source, Modulation Setup, ARB, ARB Setup, Edit RMS, Calculate RMS, RMS Calculation Mode , Marker
<b>Example</b>	:SOUR:RAD:ARB:RMS:CALC:MODE M3
Initial S/W Revision	A.14.50

#### Marker 4

Selects marker 4 to designate sample range used for RMS calculation.

Key Path	Source, Modulation Setup, ARB, ARB Setup, Edit RMS, Calculate RMS, RMS Calculation Mode , Marker
<b>Example</b>	:SOUR:RAD:ARB:RMS:CALC:MODE M4
Initial S/W Revision	A.14.50

#### Calculate RMS

Allows you to calculate current RMS based on mode selected. This will update ["Current RMS" on page 1418](#) Current RMS setting.

Key Path	Source, Modulation Setup, ARB, ARB Setup, Edit RMS, Calculate RMS
<b>Remote Command</b>	:SOURce:RADio:ARB:RMS:CALCulate
<b>Example</b>	:SOUR:RAD:ARB:RMS:CALC
Notes	<p>If no waveform is selected, invoking this operation will get error “-221 Setting conflict; No waveform is selected for RMS operation”.</p> <p>If no waveform is selected, or selected waveform is waveform sequence, the key will grey out.</p> <p>If selected waveform does not contain marker data, but <a href="#">"RMS Calculation Mode" on page 1418</a> “RMS Calculation Mode” is set to marker, under this circumstance, invoking calculation operation will get error “-221 Setting conflict; There is no marker for currently selected waveform, auto RMS calculation mode is used instead”, and <a href="#">"RMS Calculation Mode" on page 1418</a> “RMS Calculation Mode” will be coupled to “Auto” mode automatically.</p> <p>RMS calculation does not suit for waveform sequence. If selected waveform is waveform sequence file, invoking this operation will get error “-221 Setting conflict; RMS calculation does not apply to waveform sequence”. But users can still edit current RMS as play parameter, and can save current RMS to waveform sequence header for later use.</p>
Initial S/W Revision	A.14.50

#### Use Header RMS

Allows you to quickly set RMS in ARB header to ["Current RMS" on page 1418](#) Current RMS setting.

Key Path	Source, Modulation Setup, ARB, ARB Setup, Edit RMS,
Notes	<p>No remote command, front panel only.</p> <p>If no waveform is selected, the key will grey out.</p> <p>If no waveform is selected, invoking this operation will get error “-221 Setting conflict; No waveform is selected for RMS operation”.</p>
Initial S/W Revision	A.14.50

## Trigger Type

Allows access to the trigger type sub-menus. The setting for trigger type determines the behavior of the waveform when it plays.

<b>Key Path</b>	Source, Modulation Setup, ARB
<b>Remote Command</b>	:SOURce:RADio:ARB:TRIGger:TYPE CONTInuous   SINGLE   SADVance :SOURce:RADio:ARB:TRIGger:TYPE?
<b>Example</b>	:SOUR:RAD:ARB:TRIG:TYPE CONT :SOUR:RAD:ARB:TRIG:TYPE?
<b>Notes</b>	Gated trigger type will be implemented at a later release
<b>Preset</b>	CONTInuous
<b>Range</b>	Continuous   Single   Seg Adv
<b>Initial S/W Revision</b>	A.05.00

### Continuous

Sets the active trigger type to Continuous. If Continuous is already selected as the active trigger type, pressing this key allows access to the continuous trigger type setup menu. In Continuous trigger mode, the waveform repeats continuously.

<b>Key Path</b>	Source, Modulation Setup, ARB, Trigger Type
<b>Remote Command</b>	:SOURce:RADio:ARB:TRIGger:TYPE:CONTInuous[:TYPE] FREE   TRIGger   RESet :SOURce:RADio:ARB:TRIGger:TYPE:CONTInuous[:TYPE]?
<b>Example</b>	:SOUR:RAD:ARB:TRIG:TYPE:CONT FREE
<b>Preset</b>	FREE
<b>Range</b>	Free Run   Trigger + Run   Reset + Run
<b>Initial S/W Revision</b>	A.05.00

### Free Run

Selects Free Run as the trigger response for the continuous trigger type. Free Run sets the waveform generator to play a waveform sequence or segment continuously, without waiting for a trigger. In this mode, the waveform generator does not respond to triggers.

<b>Key Path</b>	Source, Modulation Setup, ARB, Trigger Type, Continuous
<b>Example</b>	:SOUR:RAD:ARB:TRIG:TYPE:CONT FREE
<b>Initial S/W Revision</b>	A.05.00



### Trigger + Run

Sets Trigger and Run as the trigger response for the continuous trigger type. Trigger and Run sets the waveform generator to play a waveform sequence or segment continuously when the first trigger is received, and to ignore any subsequent triggers.

Key Path	Source, Modulation Setup, ARB, Trigger Type, Continuous
<b>Example</b>	:SOUR:RAD:ARB:TRIG:TYPE:CONT TRIG
Initial S/W Revision	A.05.00

### Reset + Run

Sets Reset and Run as the trigger response for the continuous trigger type. Reset and Run sets the waveform generator to play a waveform sequence or segment continuously when the first trigger is received. Subsequent triggers reset the waveform sequence or segment to the start, and then play it continuously.

Key Path	Source, Modulation Setup, ARB, Trigger Type, Continuous
<b>Example</b>	:SOUR:RAD:ARB:TRIG:TYPE:CONT RES
Initial S/W Revision	A.05.00

### Single

Sets the active trigger type to Single. If Single is already selected as the active trigger type, pressing this key allows access to the single trigger type setup menu. In Single trigger mode, the waveform plays once.

Key Path	Source, Modulation Setup, ARB, Trigger Type
<b>Remote Command</b>	:SOURce:RADio:ARB:RETRigger ON OFF IMMEDIATE :SOURce:RADio:ARB:RETRigger?
<b>Example</b>	:SOUR:RAD:ARB:RETR OFF
Notes	ON: Buffered Trigger OFF: No Retrigger Immediate: Restart on Trigger This is defined as an enumerated SCPI command, with ON OFF being considered as enumerated types rather than Boolean. This means the query will return OFF instead of 0, and ON instead of 1.
Preset	ON
Range	No Retrigger   Buffered Trigger   Restart on Trigger
Initial S/W Revision	A.05.00

### No Retrigger

Selects No Retrigger as the trigger response for single trigger type. No Retrigger sets the waveform generator to play a waveform sequence or segment once when a trigger is received. Any triggers then

received during playback are ignored.

Key Path	Source, Modulation Setup, ARB, Trigger Type, Single
<b>Example</b>	:SOUR:RAD:ARB:RETR OFF
Initial S/W Revision	A.05.00

### Buffered Trigger

Selects Buffered Trigger as the trigger response for single trigger type. Buffered Trigger sets the waveform generator to play a waveform sequence or segment once when a trigger is received. If a trigger is received during playback, the waveform generator plays the sequence or segment to the end, then plays the sequence or segment once more.

Key Path	Source, Modulation Setup, ARB, Trigger Type, Single
<b>Example</b>	:SOUR:RAD:ARB:RETR ON
Initial S/W Revision	A.05.00

### Restart on Trigger

Selects Restart on Trigger as the trigger response for single trigger type. Restart on Trigger sets the waveform generator to play a waveform sequence or segment once when a trigger is received. If a trigger is received during playback, the waveform generator resets and plays the sequence or segment from the start.

Key Path	Source, Modulation Setup, ARB, Trigger Type, Single
<b>Example</b>	:SOUR:RAD:ARB:RETR IMM
Initial S/W Revision	A.05.00

### Segment Advance

Sets the active trigger type to Segment Advance. If Segment Advance is already selected as the active trigger type, pressing this key allows access to the segment advance trigger type setup menu.

Segment Advance triggering allows you to control the playback of waveform segments within a waveform sequence. When a trigger is received the ARB advances to the next waveform segment within the waveform sequence. This type of triggering ignores the repetition count for the waveform segment within the waveform sequence. For example, if a waveform segment has a repetition count of 10 and you select single segment advance triggering mode, the waveform segment will only play once.

Segment Advance triggering can also be used for waveform segments only. In this situation the same waveform segment is played again when a trigger is received.

Key Path	Source, Modulation Setup, ARB, Trigger Type
<b>Remote Command</b>	:SOURce:RADio:ARB:TRIGger:TYPE:SADVance[:TYPE] SINGLE   CONTinuous

	:SOURce:RADio:ARB:TRIGger:TYPE:SADVance[:TYPE]?
<b>Example</b>	:SOUR:RAD:ARB:TRIG:TYPE:SADV SING
Preset	CONTInuous
Range	Single   Continuous
Initial S/W Revision	A.05.00

### Single

Selects Single as the trigger response for Segment Advance trigger type. With single selected, once a trigger is received a segment is played once. If a trigger is received during playback of a segment, the segment plays to completion and the next segment is played once.

Key Path	Source, Modulation Setup, ARB, Trigger Type, Segment Advance
<b>Example</b>	:SOUR:RAD:ARB:TRIG:TYPE:SADV SING
Initial S/W Revision	A.05.00

### Continuous

Selects Continuous as the trigger response for Segment Advance trigger type. With continuous selected, once a trigger is received a segment is played continuously. When subsequent triggers are received, the currently playing segment plays to completion and then the next segment is played continuously.

Key Path	Source, Modulation Setup, ARB, Trigger Type, Segment Advance
<b>Example</b>	:SOUR:RAD:ARB:TRIG:TYPE:SADV CONT
Initial S/W Revision	A.05.00

### ARB

Allows you access to the ARB sub-menus.

Key Path	Source, Modulation Setup
Initial S/W Revision	A.05.00

### Trigger Source

The trigger source setting determines how the source receives the trigger that starts the waveform playing. Therefore, this key is grayed out if the trigger type is free run, since free run triggers immediately with no trigger source required.

Key Path	Source, Modulation Setup, ARB
<b>Remote Command</b>	:SOURce:RADio:ARB:TRIGger[:SOURce] KEY BUS EXTernal2

	:SOURce:RADio:ARB:TRIGger[:SOURce]?
<b>Example</b>	:SOUR:RAD:ARB:TRIGger KEY
Dependencies	This key is grayed out if the current trigger type is Continuous, Free Run.
Preset	EXTernal2
Range	Trigger Key   Bus   External 2
Initial S/W Revision	A.05.00

### Trigger Key

Sets the current trigger source to the front panel Trigger key. When Trigger Key is selected, the waveform is triggered when you press the front panel Trigger key.

Key Path	Source, Modulation Setup, ARB, Trigger Source
<b>Example</b>	:SOUR:RAD:ARB:TRIGger KEY
Initial S/W Revision	A.05.00

### Bus

Sets the current trigger source to Bus. Selecting Bus trigger source enables triggering over GPIB, LAN, or USB using the :SOURce:RADio:ARB:TRIGger:INITiate command.

Key Path	Source, Modulation Setup, ARB, Trigger Source
<b>Example</b>	:SOUR:RAD:ARB:TRIGger BUS
Initial S/W Revision	A.05.00

### External 2

Sets the current trigger source to External 2. Selecting External 2 enables triggering a waveform by an externally applied signal.

Key Path	Source, Modulation Setup, ARB, Trigger Source
<b>Example</b>	:SOUR:RAD:ARB:TRIGger EXT2
Notes	Note: When on E6640A, trigger 2 is a bi-directional trigger port. So when trigger 2 has been configured as OUTPUT type, choosing External 2 as the input trigger for the current step will generate error.
Initial S/W Revision	A.05.00

### External Trigger Delay

This key allows you to toggle the state and value of external trigger delay. The value you enter sets a delay time between when an external trigger is received and when it is applied to the waveform. This is key is

active only if you select external trigger as trigger source.

Key Path	Source, Modulation Setup, ARB, Trigger Source
Remote Command	:SOURce:RADio:ARB:TRIGger[:SOURce]:EXTernal:DELay <time> :SOURce:RADio:ARB:TRIGger[:SOURce]:EXTernal:DELay? SOURce:RADio:ARB:TRIGger[:SOURce]:EXTernal:DELay:STATe OFF   ON   0   1 :SOURce:RADio:ARB:TRIGger[:SOURce]:EXTernal:DELay:STATe?
Example	:SOUR:RAD:ARB:TRIG:EXT:DEL 100ns :SOUR:RAD:ARB:TRIG:EXT:DEL? :SOUR:RAD:ARB:TRIG:EXT:DEL:STAT ON :SOUR:RAD:ARB:TRIG:EXT:DEL:STAT?
Notes	External trigger delay time set by users will be rounded to the nearest integer multiple of the resolution.
Dependencies	This setting is unavailable and is grayed out when the Trigger Source is not set to external trigger.
Preset	1 ms OFF
Min	0 s
Max	8.589934588 s (Note: This value comes from $4\text{ns} * (2^{31} - 1) = 8589934588\text{ ns}$ )
Initial S/W Revision	A.14.50

### Trigger Initiate

Used to initiate an immediate trigger event if the trigger source is set to Trigger Key.

Key Path	Source, Modulation Setup, ARB
Notes	No remote command, SCPI front panel only.
Initial S/W Revision	A.05.00

### Waveform Sequences

Allows access to the waveform sequence sub-menus. Pressing this key changes the central view area to display the Waveform Sequence List view.

Key Path	Source, Modulation Setup, ARB
Notes	No remote command, SCPI front panel only.
Initial S/W Revision	A.05.00

### Build New Sequence

Allows access to the sub-menus for creating a new waveform sequence. Pressing this key changes the central view area to display the Waveform Sequence Creation and Editing view.

Key Path	Source, Modulation Setup, ARB, Waveform Sequences
Notes	No remote command, SCPI front panel only.
Initial S/W Revision	A.05.00

### Current Segment

Specifies the selected sequence segment that will be affected by the menu functions.

Key Path	Source, Modulation Setup , ARB, Waveform Sequences, Build New Sequence
Notes	No remote command, SCPI front panel only. This key is grayed out and unavailable if the sequence is currently empty.
Initial S/W Revision	A.05.00

### Insert New Waveform

Allows you access to the sub-menu for inserting a new waveform segment or sequence. Pressing this key also changes the central display to show the Waveform File Selection View.

Key Path	Source, Modulation Setup, ARB, Waveform Sequences, Build New Sequence
Notes	No remote command, SCPI front panel only. Waveform segment name string length upper limit is 128 chars. Please do NOT insert waveform which name string exceeds 128 chars.
Initial S/W Revision	A.05.00

### Insert Waveform

Inserts the currently highlighted waveform to the end of the waveform sequence. Pressing this key also returns you to the menus for creating or editing a sequence, and returns the central view to the sequence creation view.

Key Path	Source, Modulation Setup, ARB, Waveform Sequences, Build New Sequence, Insert New Waveform
Notes	No remote command, SCPI front panel only. Waveform segment name string length upper limit is 128 chars. Please do NOT insert waveform which name string exceeds 128 chars.
Initial S/W Revision	A.05.00

## Segments on Hard Disk

Allows you access to the sub-menus for loading waveform segments from the hard disk into ARB memory. The default directory is: D: varb.

Pressing this key changes the current view to the Waveform Management View.

Key Path	Source, Modulation Setup, ARB, Select Waveform
Initial S/W Revision	A.05.00

## Load Segment To ARB Memory

Allows you to load the selected file into ARB memory. On the front panel you select the file for loading to the ARB memory by highlighting the desired file in the list. Using the SCPI command, you specify the file name on the HDD.

“NVWFM” (none-volatile storage) MSUS (Mass Storage Unit Specifier) is supported in the memory subsystem because the ARB memory cannot be accessed directly. Therefore, files must be downloaded to the instrument hard disk and then loaded into the ARB memory. “NVWFM” MSUS will be mapped to the default directory D: VARB. The SCPI command supports using either “NVWFM” MSUS or specifying a full path. For more information, see Memory Subsystem (Remote Command Only).

If a file of the same name already exists within ARB memory, it is overwritten. If you wish to load two segments of the same name, you must rename one of the segments before loading it into ARB memory. To rename a segment, you can either use Windows File Explorer, or the :MMEMory:COPI command.

NOTE: When a waveform file is loaded to ARB memory, burst timing adjustments are made automatically, based on whether or not a Multiport Adapter is connected to the test set and powered on. If the connection/power status of the Multiport Adapter is changed after a waveform file has been loaded, it needs to be loaded again.

Key Path	Source, Modulation Setup, ARB, Select Waveform, Segments on Hard Disk
Remote Command	:SOURce:RADio:ARB:LOAD <string>
Example	:SOUR:RAD:ARB:LOAD "D: VARB\testwaveform.bin" or :SOUR:RAD:ARB:LOAD "NVWFM:testwaveform.bin"
Notes	<p>Because loading the file involves a delay of unpredictable length, this command should be followed by the query *OPC?, which holds off subsequent commands until the loading operating is complete.</p> <p>&lt;string&gt; – specifies the path name of the file to load from the HDD into ARB memory. It could be a &lt;full path + filename&gt;, or &lt;“NVWFM” MSUS + colon + filename&gt;.</p> <p>When in Sequence Analyzer mode, and Include Source is Yes, an attempt to load a file to ARB memory will be rejected with an error.</p> <p>When Include Source is No and if there is insufficient free ARB memory to load the selected waveform, an error is generated. .</p> <p>If you specify a file over SCPI, but the file is not at the specified location, an error is generated.</p> <p>If you try to load a waveform file but the file contains less than 500 IQ samples, an error is generated.</p> <p>If you try to load a Signal Studio waveform “*.wfm” which contains invalid waveform header, an error is generated.</p>

If the ARB is ON when you load a file to ARB memory or delete a file from ARB memory, the playing waveform segment may not keep phase continuity during the ARB memory operation. The waveform will be replayed after the ARB operation is finished.

ARB can be loaded into ARB memory even if required licenses do not present on the instrument. In this case, a GUI only warning message -800, "Operation complete; Loaded <filename> successfully, but no license <required licenses> installed". User can install required licenses according to <required licenses> string to license it, or multi-pack license it.

Initial S/W Revision	A.05.00
----------------------	---------

### Load All To ARB Memory

Allows you to load all the segment files within the currently selected directory into ARB memory. If a file of the same name already exists within ARB memory, it is overwritten. If you wish to load two segments of the same name, you must rename one of the segments before loading it into ARB memory. To rename a segment, you can either use Windows File Explorer, or the :MEMory:COpy command.

NOTE: When a waveform file is loaded to ARB memory, burst timing adjustments are made automatically, based on whether or not a Multiport Adapter is connected to the test set and powered on. If the connection/power status of the Multiport Adapter is changed after a waveform file has been loaded, it needs to be loaded again.

Key Path	Source, Modulation Setup, ARB, Select Waveform, Segments on Hard Disk
----------	-----------------------------------------------------------------------

Remote Command	:SOURce:RADio:ARB:LOAD:ALL <string>
----------------	-------------------------------------

Example	:SOUR:RAD:ARB:LOAD:ALL "D: varb"
---------	----------------------------------

Notes	<p>&lt;string&gt; - specifies the directory on the HDD to load the files into ARB memory from.</p> <p>When in Sequence Analyzer mode, and Include Source is Yes, an attempt to load all files from a directory to ARB memory is rejected with an error.</p> <p>When Include Source is No and there is insufficient free ARB memory to load all the waveforms, when the ARB memory is full, the copy ceases, and an error is generated.</p> <p>If you specify a directory over SCPI, but the directory does not exist, an error is generated.</p> <p>If the ARB is ON, a user then loads or deletes file to ARB memory, the playing waveform segment may not keep phase continuity during the ARB memory operation. The waveform will be replayed after the ARB operation is finished.</p>
-------	-------------------------------------------------------------------------------------------------------------------------------------------------------------------------------------------------------------------------------------------------------------------------------------------------------------------------------------------------------------------------------------------------------------------------------------------------------------------------------------------------------------------------------------------------------------------------------------------------------------------------------------------------------------------------------------------------------------------------------------------------------------------------------------------

Initial S/W Revision	A.05.00
----------------------	---------

### Change Directory...

Allows you to change the currently selected directory on the hard disk. Pressing this key opens a standard windows change directory dialog allowing you to select the new directory of interest.

The current directory is used for manually loading waveform segments into ARB memory for playback, and as a search location for waveform segments that are required to be loaded into ARB memory for playback of a waveform sequence or a list sequence.



Key Path	Source, Modulation Setup, ARB, Select Waveform, Segments on Hard Disk
Notes	No remote command, SCPI front panel only.
Initial S/W Revision	A.05.00

#### Default Directory...

Allows you to change the default directory. It is used as a search location for waveform segments that are required to be loaded into ARB memory for playback of a waveform sequence, and as a search location for selecting waveforms using SCPI.

Key Path	Source, Modulation Setup, ARB, Select Waveform, Segments on Hard Disk
<b>Remote Command</b>	:SOURce:RADio:ARB:DEFault:DIRectory <string> :SOURce:RADio:ARB: DEFault:DIRectory?
<b>Example</b>	:SOUR:RAD:ARB:DEF:DIR "D:\ArbFiles" :SOUR:RAD:ARB:DEF:DIR?
State Saved	Persistent, survives a power cycle and a preset but not saved in the instrument state
Initial S/W Revision	A.05.00

#### Segments in ARB Memory

Allows you access to the sub-menus for managing the files within ARB memory.

Key Path	Source, Modulation Setup, ARB, Select Waveform
Initial S/W Revision	A.05.00

#### Delete Segment From ARB Mem

Allows you to remove a segment from ARB playback memory.

Key Path	Source, Modulation Setup, ARB, Select Waveform, Segments in ARB Memory
<b>Remote Command</b>	:SOURce:RADio:ARB:DELete <string>
<b>Example</b>	:SOUR:RAD:ARB:DEL "testwaveform.bin"
Notes	<string> - specifies the waveform to be deleted from the ARB playback memory. When in Sequence Analyzer mode and Include Source is Yes, an attempt to delete a file from ARB memory is rejected with an error. When Include Source is No and you specify a file that does not exist within ARB memory, an error is generated. It is possible to delete files from within the ARB memory when the ARB is ON. However, if you attempt to delete the file that is currently playing an error is generated. It is possible to delete a file from within the ARB memory when the sequencer state is ON and the file is not being used by the List Sequencer. If you attempt to delete a file which is being used by the list

sequencer, an error is generated.

When sequencer state is On, even if ARB state is On, the selected waveform will not be played. In this case, if the selected waveform is not used in List Sequence, it can be deleted and the ARB state is turned Off.

If the ARB is ON and you load a file to ARB memory or delete a file from ARB memory, the playing waveform segment may not keep phase continuity during the ARB memory operation. The waveform will be replayed after the ARB operation is finished.

---

Initial S/W Revision      A.05.00

---

### Delete All From ARB Memory

Allows you to remove all segments from ARB playback memory.

---

**Key Path**                      Source, Modulation Setup, ARB, Select Waveform, Segments in ARB Memory

---

**Remote Command**        :SOURce:RADio:ARB:DELeTe:ALL

---

**Example**                      :SOUR:RAD:ARB:DELeTe:ALL

---

**Notes**

When in Sequence Analyzer mode and Include Source is Yes, an attempt to delete all files from ARB memory is rejected with an error.

When Include Source is No and you attempt to delete all files from ARB memory when the ARB is currently playing a file, all files except the one playing are deleted and an error is generated.

If you attempt to delete all files from ARB memory when there are waveform files used in "[List Sequencer](#)" on page 1449 and "[Sequencer](#)" on page 1449 state is ON, all files except the files currently being used in list sequencer are deleted, and an error is generated.

If the ARB is ON and you load a file to ARB memory or delete a file from ARB memory, the playing waveform segment may not keep phase continuity during the ARB memory operation. The waveform will be replayed after the ARB operation is finished.

---

Initial S/W Revision      A.05.00

---

### Edit Selected Waveform

Allows access to the sub-menus for editing the details of the currently selected waveform segment.

---

**Key Path**                      Source, Modulation Setup, ARB, Waveform Sequences, Build New Sequence

---

**Notes**                          No remote command, front panel only.

---

**Initial S/W Revision**      A.05.00

---

### Repetitions

Allows you to specify the number of times the currently selected waveform is played within the sequence.

---

**Key Path**                      Source, Modulation Setup, ARB, Waveform Sequences, Build New Sequence, Edit Selected Waveform

---

Notes	No remote command, SCPI front panel only.
Preset	1
Min	1
Max	65535
Initial S/W Revision	A.05.00

**Marker 1**

Allows you to enable or disable marker 1 for the currently selected waveform. For a waveform sequence, you can enable and disable markers on a per-segment basis, allowing you to output markers from some waveform segments within the sequence, but not for others.

Key Path	Source, Modulation Setup, ARB, Waveform Sequences, Build New Sequence, Edit Selected Waveform
Notes	No remote command, front panel only.
Preset	Enabled
Range	Enabled Disabled
Initial S/W Revision	A.05.00

**Marker 2**

Allows you to enable or disable marker 2 for the currently selected waveform. For a waveform sequence, you can enable and disable markers on a per-segment basis, allowing you to output markers from some waveform segments within the sequence, but not for others.

Key Path	Source, Modulation Setup, ARB, Waveform Sequences, Build New Sequence, Edit Selected Waveform
Notes	No remote command, front panel only.
Preset	Enabled
Range	Enabled Disabled
Initial S/W Revision	A.05.00

**Marker 3**

Allows you to enable or disable marker 3 for the currently selected waveform. For a waveform sequence, you can enable and disable markers on a per-segment basis, allowing you to output markers from some waveform segments within the sequence, but not for others.

Key Path	Source, Modulation Setup, ARB, Waveform Sequences, Build New Sequence, Edit Selected Waveform
----------	-----------------------------------------------------------------------------------------------

Notes	No remote command, front panel only.
Preset	Enabled
Range	Enabled Disabled
Initial S/W Revision	A.05.00

#### Marker 4

Allows you to enable or disable marker 4 for the currently selected waveform. For a waveform sequence, you can enable and disable markers on a per-segment basis, allowing you to output markers from some waveform segments within the sequence, but not for others.

Key Path	Source, Modulation Setup, ARB, Waveform Sequences, Build New Sequence, Edit Selected Waveform
Notes	No remote command, front panel only.
Preset	Enabled
Range	Enabled Disabled
Initial S/W Revision	A.05.00

#### Delete Segment

Allows you to delete the selected segment from the waveform sequence.

Key Path	Source, Modulation Setup, ARB, Waveform Sequences, Build New Sequence
Notes	No remote command, front panel only.
Initial S/W Revision	A.05.00

#### Save Sequence...

Pressing this key displays the “Save As” dialog. The sequence name is passed to the save as dialog to use as the filename for saving, and the directory the save as dialog will open into is the default waveform directory.

Key Path	Source, Modulation Setup, ARB, Waveform Sequences, Build New Sequence
Initial S/W Revision	A.05.00

#### Edit Selected Sequence

Allows access to the sub-menus for editing the sequence currently selected within the Waveform Sequence List view. Pressing this key changes the central view area to display the Waveform Sequence Creation and Editing view.

Key Path	Source, Modulation Setup, ARB, Waveform Sequences
Notes	No remote command, front panel only.
Initial S/W Revision	A.05.00

**Current Directory...**

Allows you to change the currently selected directory on the hard disk. Pressing this key opens a standard windows change directory dialog and allows you to select the new directory of interest.

Key Path	Source, Modulation Setup, ARB, Waveform Sequences
Notes	No remote command, front panel only.
Initial S/W Revision	A.05.00

**Waveform Utilities**

Allows you access to the waveform utilities sub-menus.

Key Path	Source, Modulation Setup, ARB
Initial S/W Revision	A.05.00

**Multi-Pack Licenses**

Allows you access to the Multi - Pack License sub-menus. Pressing this key also changes the central view area to display the Multi -Pack License Management view.

On modular instrument like E6630A or E6640A, multi-pack license operations are only allowed on the default module, i.e. “Left” module for E6630A or “TRX1” module for E6640A.

Key Path	Source, Modulation Setup, ARB, Waveform Utilities
Dependencies	This key is only available if there is at least one Multi-pack license installed on the instrument.
Initial S/W Revision	A.05.00

**Add Waveform**

Pressing this key accesses the Add Waveform sub-menu. It also changes the central display area to display the Multi-Pack License Waveform Add view.

Key Path	Source, Modulation Setup, ARB, Waveform Utilities, Multi-Pack Licenses
Dependencies	This key is only available if there is at least one slot available within at least one multi-pack license.
Initial S/W Revision	A.05.00

### Add Waveform

Allows you to add the currently selected waveform segment to a multi-pack license. The new waveform is added to the next available slot regardless of which slot was selected on the Multi-Pack License Management view.

<b>Key Path</b>	Source, Modulation Setup, ARB, Waveform Utilities, Multi-Pack Licenses, Add Waveform
<b>Remote Command</b>	:SYSTem:LKEY:WAVeform:ADD <string> or :SYSTem:LICense[:FPACK]:WAVeform:ADD <string>
<b>Example</b>	SYST:LKEY:WAV:ADD "mywaveform.wfm" or SYST:LIC:WAV:ADD "mywaveform.wfm"
<b>Notes</b>	The second SCPI :SYSTem:LICense[:FPACK]:WAVeform:ADD is provided to be consistent with the style of Keysight signal sources. You can use either one of them. Since adding a waveform segment to a Multi-Pack license causes the license slot to enter the trial period of only 48 hours, pressing this key causes a confirmation dialog to be displayed to ensure you do want to add the waveform segment to the Multi-Pack. If you attempt to license a waveform that is already licensed using another slot an error is generated. .
<b>Dependencies</b>	This key is only available if the currently selected file is a secure waveform requiring a license, and there is at least one slot available within at least one multi-pack license. If the waveform highlighted is a secure waveform, but is already licensed, this key will be unavailable.
<b>Initial S/W Revision</b>	A.05.00

### Segments on Hard Disk

Allows you access to the sub-menus for loading waveform segments from the hard disk into ARB memory. The default directory is: D: varb.

Pressing this key changes the current view to the Waveform Management View.

<b>Key Path</b>	Source, Modulation Setup, ARB, Select Waveform
<b>Initial S/W Revision</b>	A.05.00

### Load Segment To ARB Memory

Allows you to load the selected file into ARB memory. On the front panel you select the file for loading to the ARB memory by highlighting the desired file in the list. Using the SCPI command, you specify the file name on the HDD.

"NVWFM" (none-volatile storage) MSUS (Mass Storage Unit Specifier) is supported in the memory subsystem because the ARB memory cannot be accessed directly. Therefore, files must be downloaded to the instrument hard disk and then loaded into the ARB memory. "NVWFM" MSUS will be mapped to the

default directory D: VARB. The SCPI command supports using either “NVWFM” MSUS or specifying a full path. For more information, see Memory Subsystem (Remote Command Only).

If a file of the same name already exists within ARB memory, it is overwritten. If you wish to load two segments of the same name, you must rename one of the segments before loading it into ARB memory. To rename a segment, you can either use Windows File Explorer, or the :MMEMory:COPY command.

NOTE: When a waveform file is loaded to ARB memory, burst timing adjustments are made automatically, based on whether or not a Multiport Adapter is connected to the test set and powered on. If the connection/power status of the Multiport Adapter is changed after a waveform file has been loaded, it needs to be loaded again.

<b>Key Path</b>	Source, Modulation Setup, ARB, Select Waveform, Segments on Hard Disk
<b>Remote Command</b>	:SOURce:RADio:ARB:LOAD <string>
<b>Example</b>	:SOUR:RAD:ARB:LOAD “D: VARB\testwaveform.bin” or :SOUR:RAD:ARB:LOAD “NVWFM:testwaveform.bin”
<b>Notes</b>	<p>Because loading the file involves a delay of unpredictable length, this command should be followed by the query *OPC?, which holds off subsequent commands until the loading operating is complete.</p> <p>&lt;string&gt; – specifies the path name of the file to load from the HDD into ARB memory. It could be a &lt;full path + filename&gt;, or &lt;“NVWFM” MSUS + colon + filename&gt;.</p> <p>When in Sequence Analyzer mode, and Include Source is Yes, an attempt to load a file to ARB memory will be rejected with an error.</p> <p>When Include Source is No and if there is insufficient free ARB memory to load the selected waveform, an error is generated. .</p> <p>If you specify a file over SCPI, but the file is not at the specified location, an error is generated.</p> <p>If you try to load a waveform file but the file contains less than 500 IQ samples, an error is generated.</p> <p>If you try to load a Signal Studio waveform “*.wfm” which contains invalid waveform header, an error is generated.</p> <p>If the ARB is ON when you load a file to ARB memory or delete a file from ARB memory, the playing waveform segment may not keep phase continuity during the ARB memory operation. The waveform will be replayed after the ARB operation is finished.</p> <p>ARB can be loaded into ARB memory even required licenses do not present on the instrument. In this case, a GUI only warning message –800, “Operation complete; Loaded &lt;filename&gt; successfully, but no license &lt;required licenses&gt; installed”. User can install required licenses according to &lt;required licenses&gt; string to license it, or multi-pack license it.</p>
<b>Initial S/W Revision</b>	A.05.00

### Load All To ARB Memory

Allows you to load all the segment files within the currently selected directory into ARB memory. If a file of the same name already exists within ARB memory, it is overwritten. If you wish to load two segments of the same name, you must rename one of the segments before loading it into ARB memory. To rename a segment, you can either use Windows File Explorer, or the :MEMory:COPY command.

NOTE: When a waveform file is loaded to ARB memory, burst timing adjustments are made automatically, based on whether or not a Multiport Adapter is connected to the test set and powered on. If the

connection/power status of the Multiport Adapter is changed after a waveform file has been loaded, it needs to be loaded again.

<b>Key Path</b>	Source, Modulation Setup, ARB, Select Waveform, Segments on Hard Disk
<b>Remote Command</b>	:SOURce:RADio:ARB:LOAD:ALL <string>
<b>Example</b>	:SOUR:RAD:ARB:LOAD:ALL "D: varb"
<b>Notes</b>	<p>&lt;string&gt; - specifies the directory on the HDD to load the files into ARB memory from.</p> <p>When in Sequence Analyzer mode, and Include Source is Yes, an attempt to load all files from a directory to ARB memory is rejected with an error.</p> <p>When Include Source is No and there is insufficient free ARB memory to load all the waveforms, when the ARB memory is full, the copy ceases, and an error is generated.</p> <p>If you specify a directory over SCPI, but the directory does not exist, an error is generated.</p> <p>If the ARB is ON, a user then loads or deletes file to ARB memory, the playing waveform segment may not keep phase continuity during the ARB memory operation. The waveform will be replayed after the ARB operation is finished.</p>
<b>Initial S/W Revision</b>	A.05.00

#### Change Directory...

Allows you to change the currently selected directory on the hard disk. Pressing this key opens a standard windows change directory dialog allowing you to select the new directory of interest.

The current directory is used for manually loading waveform segments into ARB memory for playback, and as a search location for waveform segments that are required to be loaded into ARB memory for playback of a waveform sequence or a list sequence.

<b>Key Path</b>	Source, Modulation Setup, ARB, Select Waveform, Segments on Hard Disk
<b>Notes</b>	No remote command, SCPI front panel only.
<b>Initial S/W Revision</b>	A.05.00

#### Default Directory...

Allows you to change the default directory. It is used as a search location for waveform segments that are required to be loaded into ARB memory for playback of a waveform sequence, and as a search location for selecting waveforms using SCPI.

<b>Key Path</b>	Source, Modulation Setup, ARB, Select Waveform, Segments on Hard Disk
<b>Remote Command</b>	:SOURce:RADio:ARB:DEFault:DIRectory <string> :SOURce:RADio:ARB: DEFault:DIRectory?
<b>Example</b>	:SOUR:RAD:ARB:DEF:DIR "D:\ArbFiles" :SOUR:RAD:ARB:DEF:DIR?
<b>State Saved</b>	Persistent, survives a power cycle and a preset but not saved in the instrument state
<b>Initial S/W Revision</b>	A.05.00



## Replace Waveform

Pressing this key accesses the Replace Waveform submenu. It also changes the central display area to display the Multi-Pack License Waveform Add view.

Key Path	Source, Modulation Setup, ARB, Waveform Utilities, Multi-Pack Licenses
Dependencies	This key is only available if the currently selected slot is in the trial state.
Initial S/W Revision	A.05.00

## Replace Waveform

Allows you to replace the waveform in the currently selected slot with the waveform currently selected in the Multi-Pack License Waveform Add view.

Key Path	Source, Modulation Setup, ARB, Waveform Utilities, Multi-Pack Licenses, Replace Waveform
<b>Remote Command</b>	:SYSTem:LKEY:WAVeform:REPLace <int>, <string> or :SYSTem:LIcense[:FPACK]:WAVeform:REPLace <int>, <string>
<b>Example</b>	SYST:LKEY:WAV:REPL 1, "myotherwaveform.wfm" or :SYST:LIC:WAV:REPL 1, "myotherwaveform.wfm"
Notes	The second SCPI :SYSTem:LIcense[:FPACK]:WAVeform:REPLace is provided to be consistent with the style of Keysight signal sources. You can use either one of them. If you attempt to license a waveform that is already licensed using another slot an error is generated. Waveform slot number <int> is positive. If you attempt to input a slot number less than or equals 0, an error is generated.
Initial S/W Revision	A.05.00

## Clear Waveform from Slot

Allows you to clear the waveform from the selected slot.

Key Path	Source, Modulation Setup, ARB, Waveform Utilities, Multi-Pack Licenses
<b>Remote Command</b>	:SYSTem:LKEY:WAVeform:CLEar <int> or :SYSTem:LIcense[:FPACK]:WAVeform:CLEar <int>
<b>Example</b>	SYST:LKEY:WAV:CLE 1 or :SYST:LIC:WAV:CLE 1
Notes	The second SCPI :SYSTem:LIcense[:FPACK]:WAVeform:CLEar is provided to be consistent with the style of Keysight signal sources. You can use either one of them. Waveform slot number <int> is positive. If you attempt to input a slot number less than or equals 0, an error is generated.

error is generated.

Dependencies	This key is only available if the currently selected slot is in the trial state.
Initial S/W Revision	A.05.00

### Lock Waveform in Slot

If the selected slot is in the trial state or the lock required state, the waveform that occupies the slot is locked and permanently licensed.

Key Path	Source, Modulation Setup, ARB, Waveform Utilities, Multi-Pack Licenses
Remote Command	:SYSTem:LKEY:WAVeform:LOCK <int> or :SYSTem:LICense[:FPACK]:WAVeform:LOCK <int>
Example	SYST:LKEY:WAV:LOCK 1 or SYST:LIC:WAV:LOCK 1
Notes	The second SCPI :SYSTem:LICense[:FPACK]:WAVeform:LOCK is provided to be consistent with the style of Keysight signal sources. You can use either one of them. Waveform slot number <int> is positive. If you attempt to input a slot number less than or equals 0, an error is generated.
Dependencies	This key is only available if the currently selected slot is in the trial state or the lock required state.
Initial S/W Revision	A.05.00

### Marker Utilities

Allows access to the marker utilities sub-menus.

Key Path	Source, Modulation Setup, ARB
Initial S/W Revision	A.05.00

### Marker Polarity

Allows access to the marker polarity sub-menu, which allows you to specify the polarity for the four markers. For a positive polarity, the marker signal is high during the marker points. For a negative marker polarity, the marker signal is high during the period of no marker points.

Key Path	Source, Modulation Setup, ARB, Marker Utilities
Initial S/W Revision	A.05.00

### Mkr 1 Polarity

Allows you to set the polarity of marker 1.

Key Path	Source, Modulation Setup, ARB, Marker Utilities, Marker Polarity
Remote Command	:SOURce:RADio:ARB:MPOLarity:MARKer1 POSitive NEGative :SOURce:RADio:ARB:MPOLarity:MARKer1?
Example	:SOUR:RAD:ARB:MPOL:MARK1 NEG
Dependencies	When a new waveform is selected for playback the settings contained within the associated waveform header file are applied to the ARB. The marker polarity is one of the values stored within the header file. If the newly selected waveform file has an associated header file, the marker polarity is updated with the value from the header file. The marker polarity will remain unchanged if the newly selected waveform does not have an associated header file.
Preset	Pos
Range	Neg   Pos
Initial S/W Revision	A.05.00

### Mkr 2 Polarity

Allows you to set the polarity of marker 2.

Key Path	Source, Modulation Setup, ARB, Marker Utilities, Marker Polarity
Remote Command	:SOURce:RADio:ARB:MPOLarity:MARKer2 POSitive NEGative :SOURce:RADio:ARB:MPOLarity:MARKer2?
Example	:SOUR:RAD:ARB:MPOL:MARK2 NEG
Dependencies	When a new waveform is selected for playback the settings contained within the associated waveform header file are applied to the ARB. The marker polarity is one of the values stored within the header file. If the newly selected waveform file has an associated header file, the marker polarity is updated with the value from the header file. The marker polarity will remain unchanged if the newly selected waveform does not have an associated header file.
Preset	Pos
Range	Neg   Pos
Initial S/W Revision	A.05.00

### Mkr 3 Polarity

Allows you to set the polarity of marker 3.

Key Path	Source, Modulation Setup, ARB, Marker Utilities, Marker Polarity
Remote Command	:SOURce:RADio:ARB:MPOLarity:MARKer3 POSitive NEGative :SOURce:RADio:ARB:MPOLarity:MARKer3?
Example	:SOUR:RAD:ARB:MPOL:MARK3 NEG
Dependencies	When a new waveform is selected for playback the settings contained within the associated

	waveform header file are applied to the ARB. The marker polarity is one of the values stored within the header file. If the newly selected waveform file has an associated header file, the marker polarity is updated with the value from the header file. The marker polarity will remain unchanged if the newly selected waveform does not have an associated header file.
Preset	Pos
Range	Neg   Pos
Initial S/W Revision	A.05.00

### Mkr 4 Polarity

Allows you to set the polarity of marker 4.

Key Path	Source, Modulation Setup, ARB, Marker Utilities, Marker Polarity
Remote Command	:SOURce:RADio:ARB:MPOLarity:MARKer4 POSitive NEGative :SOURce:RADio:ARB:MPOLarity:MARKer4?
Example	:SOUR:RAD:ARB:MPOL:MARK4 NEG
Dependencies	When a new waveform is selected for playback the settings contained within the associated waveform header file are applied to the ARB. The marker polarity is one of the values stored within the header file. If the newly selected waveform file has an associated header file, the marker polarity is updated with the value from the header file. The marker polarity will remain unchanged if the newly selected waveform does not have an associated header file.
Preset	Pos
Range	Neg   Pos
Initial S/W Revision	A.05.00

### Marker Routing

Allows access to the marker routing sub-menus, which allow you to specify where the marker events are routed. It should be noted that the markers can also be routed to Trigger 1 Out and Trigger 2 Out, however this must be set up using the menus accessed by pressing the “Trigger” hard key.

Key Path	Source, Modulation Setup, ARB, Marker Utilities
Initial S/W Revision	A.05.00

### Pulse/RF Blank

Allows you to select which marker is used for the pulse/RF blanking function. The pulse/RF blanking function blanks the RF when the marker signal goes low. The marker polarity determines when the marker signal is high. For a positive polarity, this is during the marker points. For a negative polarity, this is when there are no marker points.

Marker points should be set before using this function. Enabling this function without setting marker points may create a continuous low or high signal, dependant on the marker polarity. This causes either no RF output, or a continuous RF output.

<b>Key Path</b>	Source, Modulation Setup, ARB, Marker Utilities, Marker Routing
<b>Remote Command</b>	:SOURce:RADio:ARB:MDEStination:PULSe NONE   M1   M2   M3   M4 :SOURce:RADio:ARB:MDEStination:PULSe?
<b>Example</b>	:SOUR:RAD:ARB:MDES:PULS NONE
<b>Dependencies</b>	When a new waveform is selected for playback the settings contained within the associated waveform header file are applied to the ARB. The pulse/RF blanking setting is one of the values stored within the header file. If the newly selected waveform file has an associated header file, the pulse/RF blanking setting is updated with the value from the header file. The pulse/RF blanking setting will remain unchanged if the newly selected waveform does not have an associated header file.
<b>Range</b>	None   M1   M2   M3   M4
<b>Initial S/W Revision</b>	A.05.00

#### None

Sets no marker to be used for the pulse/RF blanking function, essentially turning the RF blanking function off.

<b>Key Path</b>	Source, Modulation Setup, ARB, Marker Utilities, Marker Routing, Pulse/RF Blank
<b>Example</b>	:SOUR:RAD:ARB:MDES:PULS NONE
<b>Initial S/W Revision</b>	A.05.00

#### Marker 1

Sets marker 1 to be used for the pulse/RF blanking function.

<b>Key Path</b>	Source, Modulation Setup, ARB, Marker Utilities, Marker Routing, Pulse/RF Blank
<b>Example</b>	:SOUR:RAD:ARB:MDES:PULS M1
<b>Initial S/W Revision</b>	A.05.00

#### Marker 2

Sets marker 2 to be used for the pulse/RF blanking function.

<b>Key Path</b>	Source, Modulation Setup, ARB, Marker Utilities, Marker Routing, Pulse/RF Blank
<b>Example</b>	:SOUR:RAD:ARB:MDES:PULS M2
<b>Initial S/W Revision</b>	A.05.00

### Marker 3

Sets marker 3 to be used for the pulse/RF blanking function.

Key Path	Source, Modulation Setup, ARB, Marker Utilities, Marker Routing, Pulse/RF Blank
<b>Example</b>	:SOUR:RAD:ARB:MDES:PULS M3
Initial S/W Revision	A.05.00

### Marker 4

Sets marker 4 to be used for the pulse/RF blanking function.

Key Path	Source, Modulation Setup, ARB, Marker Utilities, Marker Routing, Pulse/RF Blank
<b>Example</b>	:SOUR:RAD:ARB:MDES:PULS M4
Initial S/W Revision	A.05.00

### ALC Hold

Allows you to specify which marker is routed for use within the ALC hold function. The ALC hold marker function holds the ALC circuitry at the average value of the sample points set by the marker.

The ALC hold function operates during the low periods of the marker signal. The marker polarity determines when the marker signal is high. For positive polarity, this is during the marker points. For a negative polarity, this is when there are no marker points.

Key Path	Source, Modulation Setup, ARB, Marker Utilities, Marker Routing
<b>Remote Command</b>	:SOURce:RADio:ARB:MDEStination:ALCHold NONE M1 M2 M3 M4 :SOURce:RADio:ARB:MDEStination:ALCHold?
<b>Example</b>	:SOUR:RAD:ARB:MDES:ALCH NONE
Dependencies	When a new waveform is selected for playback the settings contained within the associated waveform header file are applied to the ARB. The ALC hold setting is one of the values stored within the header file. If the newly selected waveform file has an associated header file, the ALC hold setting is updated with the value from the header file. The ALC hold setting will remain unchanged if the newly selected waveform does not have an associated header file.
Range	None   M1   M2   M3   M4
Initial S/W Revision	A.05.00

### None

Sets no marker to be used for the ALC hold function, essentially turning the ALC hold function off.

Key Path	Source, Modulation Setup, ARB, Marker Utilities, Marker Routing, ALC Hold
<b>Example</b>	:SOUR:RAD:ARB:MDES:PULS NONE
Initial S/W Revision	A.05.00

**Marker 1**

Sets marker 1 to be used for the ALC hold function.

Key Path	Source, Modulation Setup, ARB, Marker Utilities, Marker Routing, ALC Hold
<b>Example</b>	:SOUR:RAD:ARB:MDES:PULS M1
Initial S/W Revision	A.05.00

**Marker 2**

Sets marker 2 to be used for the ALC hold function.

Key Path	Source, Modulation Setup, ARB, Marker Utilities, Marker Routing, ALC Hold
<b>Example</b>	:SOUR:RAD:ARB:MDES:PULS M2
Initial S/W Revision	A.05.00

**Marker 3**

Sets marker 3 to be used for the ALC hold function.

Key Path	Source, Modulation Setup, ARB, Marker Utilities, Marker Routing, ALC Hold
<b>Example</b>	:SOUR:RAD:ARB:MDES:PULS M3
Initial S/W Revision	A.05.00

**Marker 4**

Sets marker 4 to be used for the ALC hold function.

Key Path	Source, Modulation Setup, ARB, Marker Utilities, Marker Routing, ALC Hold
<b>Example</b>	:SOUR:RAD:ARB:MDES:PULS M4
Initial S/W Revision	A.05.00

**Header Utilities**

Allows access to the header utilities sub-menu. Pressing this key also causes the central display area to change to display the File Header Information view.

Key Path	Source, Modulation Setup, ARB
Dependencies	This key is only available if there is currently a waveform selected for playback. If no waveform is selected, the key is grayed out.
Initial S/W Revision	A.05.00

### Clear Header

Allows you to clear the header information from the file header associated with the currently selected waveform.

<b>Key Path</b>	Source, Modulation Setup, ARB, Header Utilities
<b>Remote Command</b>	:SOURce:RADio:ARB:HEADer:CLEar
<b>Example</b>	:SOUR:RAD:ARB:HEAD:CLE
<b>Notes</b>	Attempting to clear the header details via SCPI when no waveform was selected for playback will generate an error.
<b>Initial S/W Revision</b>	A.05.00

### Save Setup To Header

Allows you to save new file header information details to the file.

<b>Key Path</b>	Source, Modulation Setup, ARB, Header Utilities
<b>Remote Command</b>	:SOURce:RADio:ARB:HEADer:SAVE
<b>Example</b>	:SOUR:RAD:ARB:HEAD:SAVE
<b>Notes</b>	Attempting to save the header details via SCPI when no waveform was selected for playback will generate an error.
<b>Initial S/W Revision</b>	A.05.00

### AM

Allows access to the menu for configuring the Amplitude Modulation.

<b>Key Path</b>	Source, Modulation Setup
<b>Initial S/W Revision</b>	A.05.00

### AM

Enables or disables the amplitude modulation.

Turning AM on when another modulation format is already on results in the previous modulation format being turned off and the generation of an error.

<b>Key Path</b>	Source, Modulation Setup, AM
<b>Remote Command</b>	:SOURce:AM:STATe :SOURce:AM:STATe?
<b>Example</b>	:SOUR:AM:STAT OFF



Preset	Off
Range	On   Off
Initial S/W Revision	A.05.00

## AM Depth

Allows you to set the amplitude modulation depth in percent.

Key Path	Source, Modulation Setup, AM
<b>Remote Command</b>	:SOURce:AM[:DEPTh] [:LINear] :SOURce:AM[:DEPTh] [:LINear]?
<b>Example</b>	:SOUR:AM 0.1
Preset	0.1 %
Min	0.1 %
Max	95.0 %
Initial S/W Revision	A.05.00

## AM Rate

Allows you to set the internal amplitude modulation rate.

Key Path	Source, Modulation Setup, AM
<b>Remote Command</b>	:SOURce:AM:INTernal:FREQuency :SOURce:AM:INTernal:FREQuency?
<b>Example</b>	:SOUR:AM:INT:FREQ 40.0 Hz
Preset	400.0 Hz
Min	10 Hz
Max	40 kHz
Initial S/W Revision	A.05.00

## FM

Allows access to the menu for configuring the frequency modulation.

Key Path	Source, Modulation Setup
Initial S/W Revision	A.05.00

## FM

Enables or disables the frequency modulation.

Turning FM on when another modulation format is already on results in the previous modulation format being turned off and the generation of an error.

Key Path	Source, Modulation Setup, FM
<b>Remote Command</b>	:SOURce:FM:STATe :SOURce:FM:STATe?
<b>Example</b>	:SOUR:FM:STAT OFF
Preset	Off
Range	On   Off
Initial S/W Revision	A.05.00

## FM Deviation

Allows you to set the frequency modulation deviation.

Key Path	Source, Modulation Setup, FM
<b>Remote Command</b>	:SOURce:FM[:DEVIation] :SOURce:FM[:DEVIation]?
<b>Example</b>	:SOUR:FM 1.00 kHz
Preset	1.00 Hz
Min	1.00 Hz
Max	100.00 kHz
Initial S/W Revision	A.05.00

## FM Rate

Allows you to set the internal frequency modulation rate.

Key Path	Source, Modulation Setup, FM
<b>Remote Command</b>	:SOURce:FM:INTernal:FREQuency :SOURce:FM:INTernal:FREQuency?
<b>Example</b>	:SOUR:FM:INT:FREQ 40.0 Hz
Preset	400.0 Hz
Min	10 Hz
Max	40 kHz
Initial S/W Revision	A.05.00

## PM

Allows access to the menu for configuring the phase modulation.

Key Path	Source, Modulation Setup
Initial S/W Revision	A.05.00

## PM

Enables or disables the phase modulation.

Turning PM on when another modulation format is already on results in the previous modulation format being turned off and the generation of an error.

Key Path	Source, Modulation Setup, PM
<b>Remote Command</b>	:SOURce:PM:STATe :SOURce:PM:STATe?
<b>Example</b>	:SOUR:PM:STAT OFF
Preset	Off
Range	On   Off
Initial S/W Revision	A.05.00

## PM Deviation

Allows you to set the phase modulation deviation.

Key Path	Source, Modulation Setup, PM
<b>Remote Command</b>	:SOURce:PM[:DEViation] :SOURce:PM[:DEViation]?
<b>Example</b>	:SOUR:PM 1.00 rad
Preset	0.1 rad
Min	0.1 rad
Max	20.0 rad
Initial S/W Revision	A.05.00

## PM Rate

Allows you to set the internal phase modulation rate.

Key Path	Source, Modulation Setup, PM
<b>Remote Command</b>	:SOURce:PM:INTernal:FREQuency :SOURce:PM:INTernal:FREQuency?

<b>Example</b>	:SOUR:PM:INT:FREQ 40.0 Hz
<b>Preset</b>	400.0 Hz
<b>Min</b>	10 Hz
<b>Max</b>	40 kHz
<b>Initial S/W Revision</b>	A.05.00

## List Sequencer

Allows you access to the sub-menus for configuring the list sequencer.

List sequences allows you to enter frequencies and amplitudes at unequal intervals in nonlinear ascending, descending or random order. Each step within the list can also include its own waveform file for playback, step duration, trigger event and trigger output.

The complexities involved in configuring the list sequencer do not lend itself to manual configuration; hence the manual configuration for this feature is limited. For easier configuration of the list sequencer, it is recommended that you use either SCPI or load a tab delimited file containing the setup parameters in a tabular form. The details of the SCPI for configuring the list sequencer can be found in Step Configuration (Remote Command Only).

Once the List Sequencer has been configured using the front panel, SCPI, or loading in a tab delimited file, the sequence must be initiated using the front panel Initiate Sequence key or the corresponding SCPI command.

<b>Key Path</b>	<b>Source</b>
<b>Initial S/W Revision</b>	A.05.00

## Sequencer

Allows you to set the state of the list sequencer. When the list sequencer is on, the source is outputting the sequence defined by the sequencer. When the list sequencer is off, the source outputs a single waveform segment or sequence (independent mode) at a single frequency and amplitude.

<b>Key Path</b>	<b>Source, List Sequencer</b>
<b>Remote Command</b>	:SOURce:LIST[:STATe] ON OFF 1 0 :SOURce:LIST[:STATe]?
<b>Example</b>	:SOUR:LIST OFF
<b>Notes</b>	When the sequencer is set to ON, the list sequencer controls the output of the source.
<b>Couplings</b>	When in Sequence Analyzer mode and the list sequencer state is Off, Include Source is forced to No, and the Include Source key is grayed out. When in Sequence Analyzer mode and the list sequencer state is On, Include Source is available to set. And, an ARB memory related operation, like load or delete will be rejected.

Preset	Off
Range	On   Off
Initial S/W Revision	A.05.00

## Initiate Sequence

Pressing this key arms the sequence for single execution. Once the sequence is armed the source begins the sequence as soon as the trigger is received. If the trigger is set to Free Run, the sequence starts immediately.

Key Path	Source, List Sequencer
<b>Remote Command</b>	:SOURce:LIST:TRIGger[:IMMediate]
<b>Example</b>	:SOUR:LIST:TRIG
Notes	<p>When in Sequence Analyzer mode and Include Source is Yes, the Initiate list sequencer operation is rejected, and the key is grayed out, since source list sequence request is sent to physics via Parallel batch by sequence analyzer.</p> <p>If the file needed by the sequencer is not already in ARB memory, the sequence cannot be initiated and an error will be generated.</p> <p>There is a blocking SCPI query which can be used to query if source list sequence being initiated successfully or not. (see Query List Sequence Initiation Armed Status (Remote Command Only) Query Source List Sequence Armed Status)</p>
Dependencies	Under the Sequence Analyzer Mode, if Meas Setup->Include Source is set to YES, Source->List Sequencer->Initiate Sequence is disabled.
Initial S/W Revision	A.05.00

## List Sequencer Setup

Allows you access to the list sequencer setup menus.

Key Path	Source, List Sequencer
----------	------------------------

### Number of Steps

Allows you to specify the number of steps within the list sequence.

Key Path	Source, List Sequencer, List Sequencer Setup
<b>Remote Command</b>	:SOURce:LIST:NUMBer:STEPs <integer> :SOURce:LIST:NUMBer:STEPs?
<b>Example</b>	:SOUR:LIST:NUMB:STEP 1
Notes	Increasing the number of steps creates additional steps at the end of the list, with all the settings

	within the steps set to their default values. Decreasing the number of steps removes steps from the end of the list. The settings within the removed steps are not reset. This means that increasing the number of steps again would allow you to retrieve these steps.
Dependencies	The Step Count parameter is increased or decreased when you insert or delete a point from within the GUI interface to the sequencer.
Preset	1
Min	1
Max	1000
Initial S/W Revision	A.05.00

### Current Step

Allows you to select the step number you wish to view or edit.

Key Path	Source, List Sequencer, List Sequencer Setup
Notes	No remote command, front panel only.
Preset	1
Min	1
Max	Step Count
Initial S/W Revision	A.05.00

### Insert Step Before

Allows you to insert a new step, containing default values, before the currently selected step. Inserting a step will automatically increase the Step Count parameter by 1. If sequence already reaches upper limit of 1000 steps, then insert more step will be rejected and popup error –221, “Setting Conflict; Cannot insert more steps, maximum number of steps reached”

Key Path	Source, List Sequencer, List Sequencer Setup
Notes	No remote command, front panel only. If the list already contains the maximum limit of 1000 steps, no operation will be made after pressing this key.
Initial S/W Revision	A.05.00

### Delete Step

Allows you to delete the current step. Deleting a step will automatically decrease the Step Count parameter by 1. If sequence only has one step left, delete step will be rejected and popup error –221, “Setting conflict; Cannot delete current step, minimum number of steps reached”

Key Path	Source, List Sequencer, List Sequencer Setup
Notes	No remote command, Front Panel key only. If the list already contains the minimum limit of 1 step, no operation will be made after pressing this key
Initial S/W Revision	A.05.00

### Clear List

Allows you to clear the list. Clearing the list sets the number of steps to the default value of 1 and sets the parameters for the only step to their default values.

Key Path	Source, List Sequencer, List Sequencer Setup
Initial S/W Revision	A.05.00

### Step Trigger

Allows access to the sub-menu for selecting the trigger input for the current step.

Key Path	Source, List Sequencer, List Sequencer Setup
<b>Remote Command</b>	:SOURce:LIST:STEP[1] 2 3...1000:SETup:INPut:TRIGger IMMEDIATE   INTERNAL   EXTERNAL2   KEY   BUS   EXTERNAL4  :SOURce:LIST:STEP[1] 2 3...1000:SETup:INPut:TRIGger?
<b>Example</b>	:SOUR:LIST:STEP2:SET:INP:TRIG BUS :SOUR:LIST:STEP2:SET:INP:TRIG?
Notes	SCPI is supported after A.09.40
Preset	Free Run
Range	Free Run   Internal   Manual (Trigger Key)   Bus   External 2   EXTERNAL4
Initial S/W Revision	A.05.00

### Free Run

Sets the trigger input for the current step to Free Run.

Key Path	Source, List Sequencer, List Sequencer Setup, Step Trigger
<b>Example</b>	:SOUR:LIST:STEP2:SET:INP:TRIG IMM
Notes	SCPI is supported after A.09.40
Initial S/W Revision	A.05.00

### Internal

Sets the trigger input for the current step to Internal.

Key Path	Source, List Sequencer, List Sequencer Setup, Step Trigger
<b>Example</b>	:SOUR:LIST:STEP2:SET:INP:TRIG INT
Notes	SCPI is supported after A.09.40
Initial S/W Revision	A.05.00

### Manual (Trigger Key)

Sets the trigger input for the current step to Manual (Trigger Key). Any step in the sequence set to Manual will cause the sequence execution to stop until the manual trigger key is pressed. Sending the Bus Trigger SCPI command will have no effect. At any point in the sequence where the list sequencer is paused waiting for a software trigger, a pop up dialog is displayed until the trigger event occurs.

Key Path	Source, List Sequencer, List Sequencer Setup, Step Trigger
<b>Example</b>	:SOUR:LIST:STEP2:SET:INP:TRIG KEY
Notes	SCPI is supported after A.09.40
Initial S/W Revision	A.05.00

### Bus

Sets the trigger input for the current step to Bus. Any step in the sequence set to Bus will cause the sequence execution to stop until the Bus Trigger SCPI command is sent. Pressing the manual trigger key has no effect. At any point in the sequence where the list sequencer is paused waiting for a software trigger, a pop up dialog is displayed until the trigger event occurs.

Key Path	Source, List Sequencer, List Sequencer Setup, Step Trigger
<b>Example</b>	:SOUR:LIST:STEP2:SET:INP:TRIG BUS
Notes	SCPI is supported after A.09.40
Initial S/W Revision	A.05.00

### External 2

Sets the trigger input for the current step to External 2.

Key Path	Source, List Sequencer, List Sequencer Setup, Step Trigger
<b>Example</b>	:SOUR:LIST:STEP2:SET:INP:TRIG EXT2
Notes	SCPI is supported after A.09.40
Notes	Note: When on E6640A, trigger 2 is a bi-directional trigger port. So when trigger 2 has been configured as OUTPUT type, choosing External 2 as the input trigger for the current step will generate error.
Initial S/W Revision	A.05.00



## Transition Time

Allows you to specify the transition time for the current step.

The transition time is the amount of time allowed for the source to settle at the current frequency or amplitude value.

Transition Time should not be taken as additional time before or inside the Step Duration. You can set a value for the settling time to allow the source output frequency or amplitude to become stable. Make sure that during this period of time, you do not use the source output signal.

The following table lists recommended values for appropriate settling times to allow for changes within the source.

Value Changed	Recommended Transition Time
Frequency	500 $\mu$ s
Amplitude	100 $\mu$ s to within 0.1 dB 20 $\mu$ s to within 1.0 dB

If the Transition Time value is shorter than the time necessary for the hardware to settle and a List Sequence is initiated, a **warning** is generated.

If the Transition Time value is longer than the Step Duration, an error is generated when initiating a source list sequence. For source list sequence, transition time is included in the step duration length. If the Transition Time value is longer than the Step Duration Time, the real step duration length is extended to equal the transition time and cause a timing shift.

Key Path	Source, List Sequencer, List Sequencer Setup
Remote Command	:SOURce:LIST:STEP[1] 2 3...1000:SETup:TRANSition:TIME <time> :SOURce:LIST:STEP[1] 2 3...1000:SETup:TRANSition:TIME?
Example	:SOUR:LIST:STEP2:SET:TRAN:TIME 1ms :SOUR:LIST:STEP2:SET:TRAN:TIME?
Notes	SCPI is supported after A.09.40
Preset	1.0 ms
Min	0.0 ms
Max	4.0 ks
Initial S/W Revision	A.05.00

## Radio Setup

Allows you access to the sub-menus for setting up the radio standard, band, and radio band link direction for the current step.

Key Path	Source, List Sequencer, List Sequencer Setup
Notes	No remote command, front panel only.

---

Initial S/W Revision	A.05.00
----------------------	---------

---

### Radio Standard

Allows access to the sub-menus for selecting the radio standard and the associated radio band for use in the current step.

---

Key Path	Source, List Sequencer, List Sequencer Setup, Radio Setup
Remote Command	:SOURce:LIST:STEP[1] 2 3...1000:SETup:RADio:BAND NONE   PGSM   EGSM   RGSM   DCS1800   PCS1900   TGSM810   GSM450   GSM480   GSM700   GSM850   BANDI   BANDII   BANDIII   BANDIV   BANDV   BANDVI   BANDVII   BANDVIII   BANDIX   BANDX   BANDXI   BANDXII   BANDXIII   BANDXIV   BANDXIX   USCELL   USPCS   JAPAN   KOREAN   NMT   IMT2K   UPPER   SECOND   PAMR400   PAMR800   IMTEXT   PCS1DOT9G   AWS   US2DOT5G   PUBLIC   LOWER   NONE   BAND1   BAND2   BAND3   BAND4   BAND5   BAND6   BAND7   BAND8   BAND10   BAND11   BAND12   BAND13   BAND14   BAND17   BAND18   BAND19   BAND20   BAND21   BAND24   BAND25   BAND26   BAND27   BAND28   BAND29   BAND30   BAND31   BAND33   BAND34   BAND35   BAND36   BAND37   BAND38   BAND39   BAND40   BAND41   BAND42   BAND43   BAND44   BANDA   BANDB   BANDC   BANDD   BANDE   BANDF  :SOURce:LIST:STEP[1] 2 3...1000:SETup: RADio:BAND?
Example	:SOUR:LIST:STEP2:SET:RAD:BAND PGSM :SOUR:LIST:STEP2:SET:RAD:BAND?
Notes	SCPI is supported after A.09.40
Initial S/W Revision	A.05.00

---

### None

Selects no radio standard for use on the current step.

---

Key Path	Source, List Sequencer, List Sequencer Setup, Radio Setup, Radio Standard
Example	:SOUR:LIST:STEP2:SET:RAD:BAND NONE
Notes	SCPI is supported after A.09.40
Initial S/W Revision	A.05.00

---

### GSM/EDGE

Pressing this key once selects GSM/EDGE as the radio standard and the current GSM/EDGE band as the active channel band. Pressing this key again allows access to the sub-menus for selecting a different GSM/EDGE band.

---

Key Path	Source, List Sequencer, List Sequencer Setup, Radio Setup, Radio Standard
Initial S/W Revision	A.05.00

---

**P-GSM**

Selects P-GSM as the band for the current step.

Key Path	Source, List Sequencer, List Sequencer Setup, Radio Setup, Radio Standard, GSM/EDGE
Initial S/W Revision	A.05.00

**E-GSM**

Selects E-GSM as the band for the current step.

Key Path	Source, List Sequencer, List Sequencer Setup, Radio Setup, Radio Standard, GSM/EDGE
Initial S/W Revision	A.05.00

**R-GSM**

Selects R-GSM as the band for the current step.

Key Path	Source, List Sequencer, List Sequencer Setup, Radio Setup, Radio Standard, GSM/EDGE
Initial S/W Revision	A.05.00

**DCS 1800**

Selects DCS 1800 as the band for the current step.

Key Path	Source, List Sequencer, List Sequencer Setup, Radio Setup, Radio Standard, GSM/EDGE
Initial S/W Revision	A.05.00

**PCS 1900**

Selects PCS 1900 as the band for the current step.

Key Path	Source, List Sequencer, List Sequencer Setup, Radio Setup, Radio Standard, GSM/EDGE
Initial S/W Revision	A.05.00

**GSM 450**

Selects GSM 450 as the band for the current step.

Key Path	Source, List Sequencer, List Sequencer Setup, Radio Setup, Radio Standard, GSM/EDGE
Initial S/W Revision	A.05.00

### GSM 480

Selects GSM 480 as the band for the current step.

Key Path	Source, List Sequencer, List Sequencer Setup, Radio Setup, Radio Standard, GSM/EDGE
Initial S/W Revision	A.05.00

### GSM 850

Selects GSM 850 as the band for the current step.

Key Path	Source, List Sequencer, List Sequencer Setup, Radio Setup, Radio Standard, GSM/EDGE
Initial S/W Revision	A.05.00

### GSM 700

Selects GSM 700 as the band for the current step.

Key Path	Source, List Sequencer, List Sequencer Setup, Radio Setup, Radio Standard, GSM/EDGE
Initial S/W Revision	A.05.00

### T-GSM 810

Selects T-GSM 810 as the band for the current step.

Key Path	Source, List Sequencer, List Sequencer Setup, Radio Setup, Radio Standard, GSM/EDGE
Initial S/W Revision	A.05.00

### WCDMA

Pressing this key once selects WCDMA as the radio standard and the current WCDMA band as the active channel band. Pressing this key again allows access to the sub-menus for selecting a different WCDMA band.

Key Path	Source, List Sequencer, List Sequencer Setup, Radio Setup, Radio Standard
Initial S/W Revision	A.05.00

### Band I

Selects Band I as the band for the current step.

---

Key Path	Source, List Sequencer, List Sequencer Setup, Radio Setup, Radio Standard, WCDMA
Initial S/W Revision	A.05.00

---

**Band II**

Selects Band II as the band for the current step.

---

Key Path	Source, List Sequencer, List Sequencer Setup, Radio Setup, Radio Standard, WCDMA
Initial S/W Revision	A.05.00

---

**Band III**

Selects Band III as the band for the current step.

---

Key Path	Source, List Sequencer, List Sequencer Setup, Radio Setup, Radio Standard, WCDMA
Initial S/W Revision	A.05.00

---

**Band IV**

Selects Band IV as the band for the current step.

---

Key Path	Source, List Sequencer, List Sequencer Setup, Radio Setup, Radio Standard, WCDMA
Initial S/W Revision	A.05.00

---

**Band V**

Selects Band V as the band for the current step.

---

Key Path	Source, List Sequencer, List Sequencer Setup, Radio Setup, Radio Standard, WCDMA
Initial S/W Revision	A.05.00

---

**Band VI**

Selects Band VI as the band for the current step.

---

Key Path	Source, List Sequencer, List Sequencer Setup, Radio Setup, Radio Standard, WCDMA
Initial S/W Revision	A.05.00

---

**Band VII**

Selects Band VII as the band for the current step.

---

Key Path	Source, List Sequencer, List Sequencer Setup, Radio Setup, Radio Standard, WCDMA
Initial S/W Revision	A.05.00

---

#### Band VIII

Selects Band VIII as the band for the current step.

---

Key Path	Source, List Sequencer, List Sequencer Setup, Radio Setup, Radio Standard, WCDMA
Initial S/W Revision	A.05.00

---

#### Band IX

Selects Band IX as the band for the current step.

---

Key Path	Source, List Sequencer, List Sequencer Setup, Radio Setup, Radio Standard, WCDMA
Initial S/W Revision	A.05.00

---

#### Band X

Selects Band X as the band for the current step.

---

Key Path	Source, List Sequencer, List Sequencer Setup, Radio Setup, Radio Standard, WCDMA
Initial S/W Revision	A.05.00

---

#### Band XI

Selects Band XI as the band for the current step.

---

Key Path	Source, List Sequencer, List Sequencer Setup, Radio Setup, Radio Standard, WCDMA
Initial S/W Revision	A.05.00

---

#### Band XII

Selects Band XII as the band for the current step.

---

Key Path	Source, List Sequencer, List Sequencer Setup, Radio Setup, Radio Standard, WCDMA
Initial S/W Revision	A.05.00

---

#### Band XIII

Selects Band XIII as the band for the current step.

Key Path	Source, List Sequencer, List Sequencer Setup, Radio Setup, Radio Standard, WCDMA
Initial S/W Revision	A.05.00

**Band XIV**

Selects Band XIV as the band for the current step.

Key Path	Source, List Sequencer, List Sequencer Setup, Radio Setup, Radio Standard, WCDMA
Initial S/W Revision	A.05.00

**LTE**

Pressing this key once selects LTE FDD as the radio standard and the current LTE FDD band as the active channel band. Pressing this key again allows access to the sub-menus for selecting a different LTE FDD band.

Key Path	Source, List Sequencer, List Sequencer Setup, Radio Setup, Radio Standard
Initial S/W Revision	A.09.50

**BAND 1**

Selects BAND 1 as the band for the current step.

Key Path	Source, List Sequencer, List Sequencer Setup, Radio Setup, Radio Standard, LTE
Initial S/W Revision	A.09.50

**BAND 2**

Selects BAND 2 as the band for the current step.

Key Path	Source, List Sequencer, List Sequencer Setup, Radio Setup, Radio Standard, LTE
Initial S/W Revision	A.09.50

**BAND 3**

Selects BAND 3 as the band for the current step.

Key Path	Source, List Sequencer, List Sequencer Setup, Radio Setup, Radio Standard, LTE
Initial S/W Revision	A.09.50

#### BAND 4

Selects BAND 4 as the band for the current step.

Key Path	Source, List Sequencer, List Sequencer Setup, Radio Setup, Radio Standard, LTE
Initial S/W Revision	A.09.50

#### BAND 5

Selects BAND 5 as the band for the current step.

Key Path	Source, List Sequencer, List Sequencer Setup, Radio Setup, Radio Standard, LTE
Initial S/W Revision	A.09.50

#### BAND 6

Selects BAND 6 as the band for the current step.

Key Path	Source, List Sequencer, List Sequencer Setup, Radio Setup, Radio Standard, LTE
Initial S/W Revision	A.09.50

#### BAND 7

Selects BAND 7 as the band for the current step.

Key Path	Source, List Sequencer, List Sequencer Setup, Radio Setup, Radio Standard, LTE
Initial S/W Revision	A.09.50

#### BAND 8

Selects BAND 8 as the band for the current step.

Key Path	Source, List Sequencer, List Sequencer Setup, Radio Setup, Radio Standard, LTE
Initial S/W Revision	A.09.50

#### BAND 9

Selects BAND 9 as the band for the current step.

Key Path	Source, List Sequencer, List Sequencer Setup, Radio Setup, Radio Standard, LTE
Initial S/W Revision	A.09.50



**BAND 10**

Selects BAND 10 as the band for the current step.

Key Path	Source, List Sequencer, List Sequencer Setup, Radio Setup, Radio Standard, LTE
Initial S/W Revision	A.09.50

**BAND 11**

Selects BAND 11 as the band for the current step.

Key Path	Source, List Sequencer, List Sequencer Setup, Radio Setup, Radio Standard, LTE
Initial S/W Revision	A.09.50

**BAND 12**

Selects BAND 12 as the band for the current step.

Key Path	Source, List Sequencer, List Sequencer Setup, Radio Setup, Radio Standard, LTE
Initial S/W Revision	A.09.50

**BAND 13**

Selects BAND 13 as the band for the current step.

Key Path	Source, List Sequencer, List Sequencer Setup, Radio Setup, Radio Standard, LTE
Initial S/W Revision	A.09.50

**BAND 14**

Selects BAND 14 as the band for the current step.

Key Path	Source, List Sequencer, List Sequencer Setup, Radio Setup, Radio Standard, LTE
Initial S/W Revision	A.09.50

**BAND 17**

Selects BAND 17 as the band for the current step.

Key Path	Source, List Sequencer, List Sequencer Setup, Radio Setup, Radio Standard, LTE
Initial S/W Revision	A.09.50

#### BAND 18

Selects BAND 18 as the band for the current step.

Key Path	Source, List Sequencer, List Sequencer Setup, Radio Setup, Radio Standard, LTE
Initial S/W Revision	A.09.50

#### BAND 19

Selects BAND 19 as the band for the current step.

Key Path	Source, List Sequencer, List Sequencer Setup, Radio Setup, Radio Standard, LTE
Initial S/W Revision	A.09.50

#### BAND 20

Selects BAND 20 as the band for the current step.

Key Path	Source, List Sequencer, List Sequencer Setup, Radio Setup, Radio Standard, LTE
Initial S/W Revision	A.09.50

#### BAND 21

Selects BAND 21 as the band for the current step.

Key Path	Source, List Sequencer, List Sequencer Setup, Radio Setup, Radio Standard, LTE
Initial S/W Revision	A.09.50

#### BAND 24

Selects BAND 24 as the band for the current step.

Key Path	Source, List Sequencer, List Sequencer Setup, Radio Setup, Radio Standard, LTE
Initial S/W Revision	A.09.50

#### BAND 25

Selects BAND 25 as the band for the current step.

Key Path	Source, List Sequencer, List Sequencer Setup, Radio Setup, Radio Standard, LTE
Initial S/W Revision	A.09.50

**BAND 26**

Selects BAND 26 as the band for the current step.

Key Path	Source, List Sequencer, List Sequencer Setup, Radio Setup, Radio Standard, LTE
Initial S/W Revision	A.12.53

**BAND 27**

Selects BAND 27 as the band for the current step.

Key Path	Source, List Sequencer, List Sequencer Setup, Radio Setup, Radio Standard, LTE
Initial S/W Revision	A.14.00

**BAND 28**

Selects BAND 28 as the band for the current step.

Key Path	Source, List Sequencer, List Sequencer Setup, Radio Setup, Radio Standard, LTE
Initial S/W Revision	A.14.00

**BAND 31**

Selects BAND 31 as the band for the current step.

Key Path	Source, List Sequencer, List Sequencer Setup, Radio Setup, Radio Standard, LTE
Initial S/W Revision	A.14.00

**LTE TDD**

Sets LTE TDD as the radio standard for use and accesses the LTE TDD specific channel band sub-menus..

Key Path	Source, Frequency, Radio Setup, Radio Standard
Initial S/W Revision	A.11.50

**BAND 33**

Selects BAND 33 as the band for the current step.

Key Path	Source, Frequency, Radio Setup, Radio Standard, LTE TDD
<b>Example</b>	:SOUR:FREQ:CHAN:BAND BAND33
Initial S/W Revision	A.11.50

#### BAND 34

Selects BAND 34 as the band for the current step.

Key Path	Source, Frequency, Radio Setup, Radio Standard, LTE TDD
<b>Example</b>	:SOUR:FREQ:CHAN:BAND BAND34
Initial S/W Revision	A.11.50

#### BAND 35

Selects BAND 35 as the band for the current step.

Key Path	Source, Frequency, Radio Setup, Radio Standard, LTE TDD
<b>Example</b>	:SOUR:FREQ:CHAN:BAND BAND35
Initial S/W Revision	A.11.50

#### BAND 36

Selects BAND 36 as the band for the current step.

Key Path	Source, Frequency, Radio Setup, Radio Standard, LTE TDD
<b>Example</b>	:SOUR:FREQ:CHAN:BAND BAND36
Initial S/W Revision	A.11.50

#### BAND 37

Selects BAND 37 as the band for the current step.

Key Path	Source, Frequency, Radio Setup, Radio Standard, LTE TDD
<b>Example</b>	:SOUR:FREQ:CHAN:BAND BAND37
Initial S/W Revision	A.11.50

#### BAND 38

Selects BAND 38 as the band for the current step.

Key Path	Source, Frequency, Radio Setup, Radio Standard, LTE TDD
<b>Example</b>	:SOUR:FREQ:CHAN:BAND BAND38
Initial S/W Revision	A.11.50

**BAND 39**

Selects BAND 39 as the band for the current step.

Key Path	Source, Frequency, Radio Setup, Radio Standard, LTE TDD
<b>Example</b>	:SOUR:FREQ:CHAN:BAND BAND39
Initial S/W Revision	A.11.50

**BAND 40**

Selects BAND 40 as the band for the current step.

Key Path	Source, Frequency, Radio Setup, Radio Standard, LTE TDD
<b>Example</b>	:SOUR:FREQ:CHAN:BAND BAND40
Initial S/W Revision	A.11.50

**BAND 41**

Selects BAND 41 as the band for the current step.

Key Path	Source, Frequency, Radio Setup, Radio Standard, LTE TDD
<b>Example</b>	:SOUR:FREQ:CHAN:BAND BAND41
Initial S/W Revision	A.11.50

**BAND 42**

Selects BAND 42 as the band for the current step.

Key Path	Source, Frequency, Radio Setup, Radio Standard, LTE TDD
<b>Example</b>	:SOUR:FREQ:CHAN:BAND BAND42
Initial S/W Revision	A.11.50

**BAND 43**

Selects BAND 43 as the band for the current step.

Key Path	Source, Frequency, Radio Setup, Radio Standard, LTE TDD
<b>Example</b>	:SOUR:FREQ:CHAN:BAND BAND43
Initial S/W Revision	A.11.50

#### BAND 44

Selects BAND 44 as the band for the current step.

Key Path	Source, List Sequencer, List Sequencer Setup, Radio Setup, Radio Standard, LTE TDD
Initial S/W Revision	A.14.00

#### TDSCDMA

Sets TDSCDMA as the radio standard for use and accesses the TDSCDMA specific channel band sub-menus..

Key Path	Source, Frequency, Radio Setup, Radio Standard
Initial S/W Revision	A.11.50

#### BAND A

Selects BAND A as the band for the current step.

Key Path	Source, Frequency, Radio Setup, Radio Standard, TDSCDMA
<b>Example</b>	:SOUR:FREQ:CHAN:BAND BANDA
Initial S/W Revision	A.11.50

#### BAND B

Selects BAND B as the band for the current step.

Key Path	Source, Frequency, Radio Setup, Radio Standard, TDSCDMA
<b>Example</b>	:SOUR:FREQ:CHAN:BAND BANDB
Initial S/W Revision	A.11.50

#### BAND C

Selects BAND C as the band for the current step.

Key Path	Source, Frequency, Radio Setup, Radio Standard, TDSCDMA
<b>Example</b>	:SOUR:FREQ:CHAN:BAND BANDC
Initial S/W Revision	A.11.50

#### BAND D

Selects BAND D as the band for the current step.

Key Path	Source, Frequency, Radio Setup, Radio Standard, TDSCDMA
<b>Example</b>	:SOUR:FREQ:CHAN:BAND BANDD
Initial S/W Revision	A.11.50

**BAND E**

Selects BAND E as the band for the current step.

Key Path	Source, Frequency, Radio Setup, Radio Standard, TDSCDMA
<b>Example</b>	:SOUR:FREQ:CHAN:BAND BANDE
Initial S/W Revision	A.11.50

**BAND F**

Selects BAND F as the band for the current step.

Key Path	Source, Frequency, Radio Setup, Radio Standard, TDSCDMA
<b>Example</b>	:SOUR:FREQ:CHAN:BAND BANDF
Initial S/W Revision	A.11.50

**Radio Band Link**

Allows you to specify the radio band link direction for the steps within the list sequence. The link is used in conjunction with the channel band and channel number to determine the output frequency.

When set to “Uplink”, the source will calculate the uplink frequency according to an uplink formula together with selected channel band and channel number. When set to “Downlink”, the source will calculate the downlink frequency according to a downlink formula together with selected channel band and channel number.

Key Path	Source, List Sequencer, List Sequencer Setup, Radio Setup
<b>Remote Command</b>	:SOURce:LIST:STEP[1] 2 3...1000:SETup:RADio:BAND:LINK DOWN UP :SOURce:LIST:STEP[1] 2 3...1000:SETup:RADio:BAND:LINK?
<b>Example</b>	:SOUR:LIST:STEP2:SET:RAD:BAND:LINK UP :SOUR:LIST:STEP2:SET:RAD:BAND:LINK?
Notes	SCPI is supported after A.09.40
Preset	DOWN
Range	DOWN   UP
Initial S/W Revision	A.05.00

## Channel

Allows you to specify the frequency of the current step via a channel number.

<b>Key Path</b>	Source, List Sequencer, List Sequencer Setup
<b>Remote Command</b>	:SOURce:LIST:STEP[1] 2 3...1000:SETup:CNFRrequency <double> :SOURce:LIST:STEP[1] 2 3...1000:SETup:CNFRrequency?
<b>Example</b>	:SOUR:LIST:STEP2:SET:CNFR 124 :SOUR:LIST:STEP2:SET:CNFR?
<b>Notes</b>	SCPI is supported after A.09.40. This SCPI is used to setup channel number or frequency setting, according to current Radio Band setting. If Radio Band is "NONE", then it's frequency. If Radio Band is not "NONE", then it's channel number.
<b>Couplings</b>	The channel number is coupled to the step frequency value. When the step frequency value is changed, the channel number will increase or decrease to match the new step frequency. If the step frequency is not at an exact match for a channel number, the nearest channel number is displayed, along with a greater than, or less than sign to indicate the frequency is above or below the channel number.
<b>Preset</b>	1
<b>Min</b>	0 (Please refer to for valid ranges.)
<b>Max</b>	10838 (Please refer to for valid ranges.)
<b>Initial S/W Revision</b>	A.05.00

## Frequency

Allows you to specify a frequency value for the current step.

<b>Key Path</b>	Source, List Sequencer, List Sequencer Setup
<b>Remote Command</b>	:SOURce:LIST:STEP[1] 2 3...1000:SETup:CNFRrequency <double> :SOURce:LIST:STEP[1] 2 3...1000:SETup:CNFRrequency?
<b>Example</b>	:SOUR:LIST:STEP2:SET:CNFR 1GHz :SOUR:LIST:STEP2:SET:CNFR?
<b>Notes</b>	SCPI is supported after A.09.40. This SCPI is used to setup channel number or frequency setting, according to current Radio Band setting. If Radio Band is "NONE", then it's frequency. If Radio Band is not "NONE", then it's channel number.
<b>Couplings</b>	The frequency value is coupled to the channel band and number for the step, such that updates to the radio band and channel number will update the frequency value to the corresponding absolute frequency. The reverse is also true, changing the frequency value causes the value of the channel number to be updated.
<b>Preset</b>	1.00 GHz
<b>Min</b>	10.00 MHz
<b>Max</b>	Hardware Dependant:



	Option 503 = 3.6 GHz Option 504 = 3.9 GHz Option 506 = 6.00 GHz
Initial S/W Revision	A.05.00

## Power

Allows you to specify a power value for the current step.

Key Path	Source, List Sequencer, List Sequencer Setup
Remote Command	:SOURce:LIST:STEP[1] 2 3...1000:SETup:AMPLitude <double> :SOURce:LIST:STEP[1] 2 3...1000:SETup:AMPLitude?
Example	:SOUR:LIST:STEP2:SET:AMPL -50dBm :SOUR:LIST:STEP2:SET:AMPL?
Notes	SCPI is supported after A.09.40
Notes	Amplitude corrections can be specified for use with the source. In the event of amplitude corrections being applied, the valid ranges for the RF power do not change dependant on the current amplitude correction setting. Instead, if the combination of RF power + amplitude correction is higher or lower than the source output range, the Source Unleveled bit is set and the "Source Unleveled" indicator will appear on status panel to indicate that the source cannot maintain the output power that has been requested.  The multiport adapter RFIO TX ports and GPS ports cannot ensure power accuracy when power setting is lower than -130dBm, this power setting value is defined by the sum of RF Power setting and related amplitude correction value. But user settable value could be lower than this limit. When application detected there exists power setting lower than -130dBm on MPA RFIO TX ports, then popup warning message . When application detected there exists power setting lower than -130dBm on MPA GPS ports, then popup warning message . These are only warning messages, and check is performed when RF is ON.
Notes	The Min and Max value here defined UI settable amplitude range. This range is larger than actual amplitude range with level accuracy defined in spec.
Dependencies	The RF power is dependent on the RF output port and frequency, such that the current frequency and selected output port determine the valid range of power values.
Preset	-100 dBm
Min	The range of values depends on the current frequency and selected RF output port. Please refer to <a href="#">"RF Power" on page 1379</a> and the table RF Power Range for the valid ranges.
Max	The range of values depends on the current frequency and selected RF output port. Please refer to <a href="#">"RF Power" on page 1379</a> and the table RF Power Range for the valid ranges.
Initial S/W Revision	A.05.00

## Waveform

Allows you access to the sub-menus for selecting the waveform to be played back during the current step. Pressing this key also changes the central display area to show the Waveform File Selection view.

Key Path	Source, List Sequencer, List Sequencer Setup
Remote Command	:SOURce:LIST:STEP[1] 2 3...1000:SETup:WAVeform <string> :SOURce:LIST:STEP[1] 2 3...1000:SETup:WAVeform?
Example	:SOUR:LIST:STEP2:SET:WAV "CW" :SOUR:LIST:STEP2:SET:WAV?
Notes	SCPI is supported after A.09.40
Remote Command Notes	String type, takes "Off"   "CW"   "Cont"   "waveform name"
Preset	CW
Range	Waveform   Continue Previous   CW   Off
Initial S/W Revision	A.05.00

### CW

Sets the current step to output a CW tone.

Key Path	Source, List Sequencer, List Sequencer Setup, Waveform
Example	:SOUR:LIST:STEP2:SET:WAV "CW"
Notes	SCPI is supported after A.09.40
Initial S/W Revision	A.05.00

### Selected Waveform

Inserts the currently selected waveform in the waveform selection view as the waveform for playback during the current step.

Key Path	Source, List Sequencer, List Sequencer Setup, Waveform
Example	:SOUR:LIST:STEP2:SET:WAV "waveform name"
Notes	SCPI is supported after A.09.40 If the selected waveform contains header (which contains ARB play parameters), source list sequence will automatically apply header settings of the selected waveform in that step.
Initial S/W Revision	A.05.00

### Continue Previous

Sets the current step to continue with playback of the waveform from the previous step. When continuing the previous waveform, the ARB playback will not pause while the source retunes to the new frequency or amplitude that may be defined for the new step.

Key Path	Source, List Sequencer, List Sequencer Setup, Waveform
----------	--------------------------------------------------------

<b>Example</b>	:SOUR:LIST:STEP2:SET:WAV "Cont"
Notes	SCPI is supported after A.09.40
Initial S/W Revision	A.05.00

**Off**

Disable RF output of the current step.

Key Path	Source, List Sequencer, List Sequencer Setup, Waveform
<b>Example</b>	:SOUR:LIST:STEP2:SET:WAV "Off"
Notes	SCPI is supported after A.09.40
Initial S/W Revision	A.05.00

**Segments on Hard Disk**

Allows you access to the sub-menus for loading waveform segments from the hard disk into ARB memory. The default directory is: D: varb.

Pressing this key changes the current view to the Waveform Management View.

Key Path	Source, Modulation Setup, ARB, Select Waveform
Initial S/W Revision	A.05.00

**Load Segment To ARB Memory**

Allows you to load the selected file into ARB memory. On the front panel you select the file for loading to the ARB memory by highlighting the desired file in the list. Using the SCPI command, you specify the file name on the HDD.

"NVWFM" (none-volatile storage) MSUS (Mass Storage Unit Specifier) is supported in the memory subsystem because the ARB memory cannot be accessed directly. Therefore, files must be downloaded to the instrument hard disk and then loaded into the ARB memory. "NVWFM" MSUS will be mapped to the default directory D: VARB. The SCPI command supports using either "NVWFM" MSUS or specifying a full path. For more information, see Memory Subsystem (Remote Command Only).

If a file of the same name already exists within ARB memory, it is overwritten. If you wish to load two segments of the same name, you must rename one of the segments before loading it into ARB memory. To rename a segment, you can either use Windows File Explorer, or the :MMEMory:COPY command.

NOTE: When a waveform file is loaded to ARB memory, burst timing adjustments are made automatically, based on whether or not a Multiport Adapter is connected to the test set and powered on. If the connection/power status of the Multiport Adapter is changed after a waveform file has been loaded, it needs to be loaded again.

<b>Key Path</b>	Source, Modulation Setup, ARB, Select Waveform, Segments on Hard Disk
<b>Remote Command</b>	:SOURce:RADio:ARB:LOAD <string>
<b>Example</b>	:SOUR:RAD:ARB:LOAD "D: VARB\testwaveform.bin" or :SOUR:RAD:ARB:LOAD "NVWFM:testwaveform.bin"
<b>Notes</b>	<p>Because loading the file involves a delay of unpredictable length, this command should be followed by the query *OPC?, which holds off subsequent commands until the loading operating is complete.</p> <p>&lt;string&gt; – specifies the path name of the file to load from the HDD into ARB memory. It could be a &lt;full path + filename&gt;, or &lt;"NVWFM" MSUS + colon + filename&gt;.</p> <p>When in Sequence Analyzer mode, and Include Source is Yes, an attempt to load a file to ARB memory will be rejected with an error.</p> <p>When Include Source is No and if there is insufficient free ARB memory to load the selected waveform, an error is generated. .</p> <p>If you specify a file over SCPI, but the file is not at the specified location, an error is generated.</p> <p>If you try to load a waveform file but the file contains less than 500 IQ samples, an error is generated.</p> <p>If you try to load a Signal Studio waveform "*.wfm" which contains invalid waveform header, an error is generated.</p> <p>If the ARB is ON when you load a file to ARB memory or delete a file from ARB memory, the playing waveform segment may not keep phase continuity during the ARB memory operation. The waveform will be replayed after the ARB operation is finished.</p> <p>ARB can be loaded into ARB memory even required licenses do not present on the instrument. In this case, a GUI only warning message –800, "Operation complete; Loaded &lt;filename&gt; successfully, but no license &lt;required licenses&gt; installed". User can install required licenses according to &lt;required licenses&gt; string to license it, or multi-pack license it.</p>
<b>Initial S/W Revision</b>	A.05.00

### Load All To ARB Memory

Allows you to load all the segment files within the currently selected directory into ARB memory. If a file of the same name already exists within ARB memory, it is overwritten. If you wish to load two segments of the same name, you must rename one of the segments before loading it into ARB memory. To rename a segment, you can either use Windows File Explorer, or the :MEMory:COpy command.

NOTE: When a waveform file is loaded to ARB memory, burst timing adjustments are made automatically, based on whether or not a Multiport Adapter is connected to the test set and powered on. If the connection/power status of the Multiport Adapter is changed after a waveform file has been loaded, it needs to be loaded again.

<b>Key Path</b>	Source, Modulation Setup, ARB, Select Waveform, Segments on Hard Disk
<b>Remote Command</b>	:SOURce:RADio:ARB:LOAD:ALL <string>
<b>Example</b>	:SOUR:RAD:ARB:LOAD:ALL "D: varb"
<b>Notes</b>	<p>&lt;string&gt; - specifies the directory on the HDD to load the files into ARB memory from.</p> <p>When in Sequence Analyzer mode, and Include Source is Yes, an attempt to load all files from a directory to ARB memory is rejected with an error.</p>

---

When Include Source is No and there is insufficient free ARB memory to load all the waveforms, when the ARB memory is full, the copy ceases, and an error is generated.

If you specify a directory over SCPI, but the directory does not exist, an error is generated.

If the ARB is ON, a user then loads or deletes file to ARB memory, the playing waveform segment may not keep phase continuity during the ARB memory operation. The waveform will be replayed after the ARB operation is finished.

---

Initial S/W Revision	A.05.00
----------------------	---------

---

### Change Directory...

Allows you to change the currently selected directory on the hard disk. Pressing this key opens a standard windows change directory dialog allowing you to select the new directory of interest.

The current directory is used for manually loading waveform segments into ARB memory for playback, and as a search location for waveform segments that are required to be loaded into ARB memory for playback of a waveform sequence or a list sequence.

---

Key Path	Source, Modulation Setup, ARB, Select Waveform, Segments on Hard Disk
Notes	No remote command, SCPI front panel only.
Initial S/W Revision	A.05.00

---

### Default Directory...

Allows you to change the default directory. It is used as a search location for waveform segments that are required to be loaded into ARB memory for playback of a waveform sequence, and as a search location for selecting waveforms using SCPI.

---

Key Path	Source, Modulation Setup, ARB, Select Waveform, Segments on Hard Disk
<b>Remote Command</b>	:SOURce:RADio:ARB:DEFault:DIRectory <string> :SOURce:RADio:ARB: DEFault:DIRectory?
<b>Example</b>	:SOUR:RAD:ARB:DEF:DIR "D:\ArbFiles" :SOUR:RAD:ARB:DEF:DIR?
State Saved	Persistent, survives a power cycle and a preset but not saved in the instrument state
Initial S/W Revision	A.05.00

---

### Segments in ARB Memory

Allows you access to the sub-menus for managing the files within ARB memory.

---

Key Path	Source, Modulation Setup, ARB, Select Waveform
Initial S/W Revision	A.05.00

---

### Delete Segment From ARB Mem

Allows you to remove a segment from ARB playback memory.

<b>Key Path</b>	Source, Modulation Setup, ARB, Select Waveform, Segments in ARB Memory
<b>Remote Command</b>	:SOURce:RADio:ARB:DELeTe <string>
<b>Example</b>	:SOUR:RAD:ARB:DEL "testwaveform.bin"
<b>Notes</b>	<p>&lt;string&gt; - specifies the waveform to be deleted from the ARB playback memory.</p> <p>When in Sequence Analyzer mode and Include Source is Yes, an attempt to delete a file from ARB memory is rejected with an error.</p> <p>When Include Source is No and you specify a file that does not exist within ARB memory, an error is generated.</p> <p>It is possible to delete files from within the ARB memory when the ARB is ON. However, if you attempt to delete the file that is currently playing an error is generated.</p> <p>It is possible to delete a file from within the ARB memory when the sequencer state is ON and the file is not being used by the List Sequencer. If you attempt to delete a file which is being used by the list sequencer, an error is generated.</p> <p>When sequencer state is On, even if ARB state is On, the selected waveform will not be played. In this case, if the selected waveform is not used in List Sequence, it can be deleted and the ARB state is turned Off.</p> <p>If the ARB is ON and you load a file to ARB memory or delete a file from ARB memory, the playing waveform segment may not keep phase continuity during the ARB memory operation. The waveform will be replayed after the ARB operation is finished.</p>
<b>Initial S/W Revision</b>	A.05.00

### Delete All From ARB Memory

Allows you to remove all segments from ARB playback memory.

<b>Key Path</b>	Source, Modulation Setup, ARB, Select Waveform, Segments in ARB Memory
<b>Remote Command</b>	:SOURce:RADio:ARB:DELeTe:ALL
<b>Example</b>	:SOUR:RAD:ARB:DELeTe:ALL
<b>Notes</b>	<p>When in Sequence Analyzer mode and Include Source is Yes, an attempt to delete all files from ARB memory is rejected with an error.</p> <p>When Include Source is No and you attempt to delete all files from ARB memory when the ARB is currently playing a file, all files except the one playing are deleted and an error is generated.</p> <p>If you attempt to delete all files from ARB memory when there are waveform files used in "<b>List Sequencer</b>" on page 1449 and "<b>Sequencer</b>" on page 1449 state is ON, all files except the files currently being used in list sequencer are deleted, and an error is generated.</p> <p>If the ARB is ON and you load a file to ARB memory or delete a file from ARB memory, the playing waveform segment may not keep phase continuity during the ARB memory operation. The waveform will be replayed after the ARB operation is finished.</p>
<b>Initial S/W Revision</b>	A.05.00

## Step Duration

Allows access to the sub-menus for setting up the duration of play for the current step.

The duration can be set to be either the number of times for the ARB file associated with the sequence to play, or a specific time value, or continuous. If the step is set to play a CW tone, the step duration cannot be set to a play count.

<b>Key Path</b>	Source, List Sequencer, List Sequencer Setup
<b>Remote Command</b>	:SOURce:LIST:STEP[1] 2 3...1000:SETup:DURation:TYPE TIME   COUNT   CONTInuous   CABort :SOURce:LIST:STEP[1] 2 3...1000:SETup:DURation:TYPE?
<b>Example</b>	:SOUR:LIST:STEP2:SET:DUR:TYPE TIME :SOUR:LIST:STEP2:SET:DUR:TYPE?
<b>Notes</b>	SCPI is supported after A.09.40
<b>Notes</b>	If “Step Duration” is set to “Time” or “Play Count” for the last step, the last step of ARB keeps playing as if set to “Continuous”, until the set “Time” has expired or until the “Play Count” setting is reached. However, you can query <b>Error! Reference source not found.</b> Source Sweeping Condition Message to find out if the current list sequence is complete or not.
<b>Range</b>	Time   Play Count   Continuous   Continuous Abort
<b>Initial S/W Revision</b>	A.05.00

## Time

Sets the duration of the current step to be a time value for the length of time the step will play. Pressing this key again opens another menu which allows you to set the time value for the step duration.

<b>Key Path</b>	Source, List Sequencer, List Sequencer Setup, Step Duration
<b>Example</b>	:SOUR:LIST:STEP2:SET:DUR:TYPE TIME
<b>Notes</b>	SCPI is supported after A.09.40
<b>Initial S/W Revision</b>	A.05.00

## Duration Time

Allows you to specify the length of time the current step will play.

If the Transition Time value is longer than the Step Duration Time, an error is generated when initiating a source list sequence. For source list sequence, transition time is included in the step duration length (not occupy additional time). If the Transition Time value is longer than the Step Duration Time, the real step duration length is extended to equal the transition time and cause a timing shift. This check is also described in section **Error! Reference source not found.** List Sequence Step Validation.

<b>Key Path</b>	Source, List Sequencer, List Sequencer Setup, Step Duration, Time
<b>Remote Command</b>	:SOURce:LIST:STEP[1] 2 3...1000:SETup:DURation:TCOUNT <double> :SOURce:LIST:STEP[1] 2 3...1000:SETup:DURation:TCOUNT?

<b>Example</b>	:SOUR:LIST:STEP2:SET:DUR:TCO 1s :SOUR:LIST:STEP2:SET:DUR:TCO?
<b>Notes</b>	SCPI is supported after A.09.40 This SCPI is reused by "Play Count", "Duration Time" and "Continuous Abort" according to current Duration Type setting is "Play Count" or "Duration Time" or "Continuous Abort". If current "Duration Type" is "Continuous", then popup error -221, "Settings conflict; Cannot accept time or count input when step duration type is Continuous on step #"
<b>Notes</b>	If "Duration Time" is set for the last step, the last step of ARB keeps playing as if set to "Continuous" after set time expires. However, you can query Source Sweeping Condition Message (:STAT:OPER:COND?) to find out if the current list sequence is complete or not.
<b>Preset</b>	1.00 ms
<b>Min</b>	100 μs
<b>Max</b>	1800 s
<b>Initial S/W Revision</b>	A.05.00

### Play Count

Sets the duration of the current step to be an integer value for the number of times (play count) the ARB file is selected for playback during this step. For example, a 5 second ARB will be set to play 5 times during the step.

<b>Key Path</b>	Source, List Sequencer, List Sequencer Setup, Step Duration
<b>Example</b>	:SOUR:LIST:STEP2:SET:DUR:TYPE COUN
<b>Notes</b>	SCPI is supported after A.09.40 This key is unavailable and is grayed out if the current step is configured to CW tone rather than an ARB waveform.
<b>Initial S/W Revision</b>	A.05.00

### Header Utilities

Allows access to the header utilities sub-menu. Pressing this key also causes the central display area to change to display the File Header Information view.

<b>Key Path</b>	Source, Modulation Setup, ARB
<b>Dependencies</b>	This key is only available if there is currently a waveform selected for playback. If no waveform is selected, the key is grayed out.
<b>Initial S/W Revision</b>	A.05.00

### Continuous

Sets the current step to be played continuously until the next step starts. The waveform will always play completely before transitioning to the next step.



Key Path	Source, List Sequencer, List Sequencer Setup, Step Duration
<b>Example</b>	:SOUR:LIST:STEP2:SET:DUR:TYPE CONT
Notes	SCPI is supported after A.09.40
Initial S/W Revision	A.05.00

## Output Trigger

Allows you to specify the trigger output for the current step. The trigger output signal is sent at the start of the step.

When select “On”, trigger event will occur on both Internal and External2 paths. Select “Off” will turn off trigger output.

Key Path	Source, List Sequencer, List Sequencer Setup
<b>Remote Command</b>	:SOURce:LIST:STEP[1] 2 3...1000:SETup:OUTPut:TRIGger ON   OFF   1   0 :SOURce:LIST:STEP[1] 2 3...1000:SETup:OUTPut:TRIGger
<b>Example</b>	:SOUR:LIST:STEP2:SET:OUTP:TRIG ON :SOUR:LIST:STEP2:SET:OUTP:TRIG?
Notes	SCPI is supported after A.09.40
Preset	Off
Range	On Off
Initial S/W Revision	A.05.00

## Repetition

Allows access to the sub-menu for selecting the repetition type for the list sequencer globally. It cannot be changed between different sequence steps.

Key Path	Source, List Sequencer
<b>Remote Command</b>	:SOURce:LIST:REPetition:TYPE SINGLE CONTInuous
<b>Example</b>	:SOUR:LIST:REP:TYPE SING :SOUR:LIST:REP:TYPE?
Preset	SINGle
Range	SINGle CONTInuous
Initial S/W Revision	A.14.50

## Single

Sets the repetition type as single for the whole source sequence. Source list will play one time after initiation.

Key Path	Source, List Sequencer, Repetition
<b>Example</b>	:SOUR:LIST:REP:TYPE SINGLE
Initial S/W Revision	A.14.50

### Continuous

Sets the repetition type as continuous for the whole source sequence. Source list will play continuously after initiation.

Key Path	Source, List Sequencer, Repetition
<b>Example</b>	:SOUR:LIST:REP:TYPE CONTInuous
Initial S/W Revision	A.14.50

### Trigger Type

Allows access to the sub-menu for selecting the output trigger type for the list sequencer globally. It cannot be changed between different sequence steps.

Key Path	Source, List Sequencer
<b>Remote Command</b>	:SOURce:LIST:TRIGgerout:TYPe BEGInningofstep DATamarker
<b>Example</b>	:SOUR:LIST:TRIG:TYP BEG :SOUR:LIST:TRIG:TYP?
Notes	SCPI is supported after A.14.00
Preset	BEGInningofstep
Range	BEGInningofstep DATamarker
Initial S/W Revision	A.14.00

### BeginningOfStep

Sets the output trigger type as BeginningOfStep for the whole source sequence.

Key Path	Source, List Sequencer, Trigger Type
<b>Example</b>	:SOUR:LIST:TRIG:TYP BEG
Notes	SCPI is supported after A.14.00
Initial S/W Revision	A.14.00

## DataMarker

Sets the output trigger type as DataMarker for the whole source sequence. When DataMarker is selected, which marker to route is also needed to be set.

Key Path	Source, List Sequencer, Trigger Type
<b>Example</b>	:SOUR:LIST:TRIG:TYP DAT
Notes	SCPI is supported after A.14.00
Initial S/W Revision	A.14.00

## Marker 1

Sets the output trigger maker routing to Marker 1 for DataMarker in the whole source sequence.

Key Path	Source, List Sequencer, Trigger Type, DataMarker
<b>Example</b>	:SOUR:LIST:TRIG:TYPE:MARK M1
Notes	SCPI is supported after A.14.00
Initial S/W Revision	A.14.00

## Marker 2

Sets the output trigger maker routing to Marker 2 for DataMarker in the whole source sequence.

Key Path	Source, List Sequencer, Trigger Type, DataMarker
<b>Example</b>	:SOUR:LIST:TRIG:TYPE:MARK M2
Notes	SCPI is supported after A.14.00
Initial S/W Revision	A.14.00

## Marker 3

Sets the output trigger maker routing to Marker 3 for DataMarker in the whole source sequence.

Key Path	Source, List Sequencer, Trigger Type, DataMarker
<b>Example</b>	:SOUR:LIST:TRIG:TYPE:MARK M3
Notes	SCPI is supported after A.14.00
Initial S/W Revision	A.14.00

#### Marker 4

Sets the output trigger maker routing to Marker 4 for DataMarker in the whole source sequence.

Key Path	Source, List Sequencer, Trigger Type, DataMarker
<b>Example</b>	:SOUR:LIST:TRIG:TYPE:MARK M4
Notes	SCPI is supported after A.14.00
Initial S/W Revision	A.14.00

#### Manual Trigger Now

Pressing this key provides a software trigger event to the list sequencer. During execution of sequence, if the sequencer is halted on any step that has been configured with a “Manual” step trigger, then this key press will cause the sequencer to continue and execute the step.

Key Path	Source, List Sequencer
<b>Remote Command</b>	No remote command, front panel only.
Initial S/W Revision	A.05.00

#### Source Preset

Allows you to preset the source settings to their default values.

Key Path	Source
<b>Remote Command</b>	:SOURce:PRESet
<b>Example</b>	:SOUR:PRES

## Span X Scale

Accesses a menu of functions that enable you set the horizontal scale parameters.

Key Path	Front-panel key
Initial S/W Revision	Prior to A.02.00

### Span

Changes the frequency range symmetrically about the center frequency.

The default (and minimum) Span is calculated using the number of carriers and the carrier width where;

$$\text{Span} = (\text{Upper Carrier Freq} + (\text{max offset IBW} * (1 + \alpha)) / 2) - (\text{Lower Carrier Freq} - (\text{max offset IBW} * (1 + \alpha)) / 2)$$

The span is increased by a factor of 1 + Filter Alpha if the RRC Filter is on.

Key Path	Span X Scale
Mode	SA, WCDMA, C2K, WIMAX OFDMA, 1xEVDO, DVB-T/H, DTMB (CTTB), ISDB-T, CMMB, LTE, LTETDD, Digital Cable TV, WLAN, LTEAFDD, LTEATDD
Remote Command	[ :SENSe ] :CHPower:FREQuency:SPAN <freq> [ :SENSe ] :CHPower:FREQuency:SPAN?
Example	CHP:FREQ:SPAN 10 MHz CHP:FREQ:SPAN?
Notes	You must be in the Spectrum Analysis mode, W-CDMA mode, cdma2000 mode, DVB-T/H mode, DTMB (CTTB) mode, ISDB-T mode, CMMB mode, Digital Cable TV mode, LTE mode, LTE TDD mode, WLAN mode, 1xEVDO mode or WIMAX OFDMA mode to use this command. Use :INSTrument:SElect to set the mode.
Dependencies	For MSR mode, this key is blank. For LTE-Advanced FDD/TDD mode, this key is blank. In order to keep backwards compatible with the legacy LTE FDD/TDD, the scpi command is supported in LTE & LTE-A converged application. For WLAN 802.11ac (80 MHz + 80 MHz), the key is not enabled and its value is coupled with the spacing between the center frequencies of the two carriers. Span =  Center Frequency 1 - Center Frequency 2  + Integ BW + 40 MHz Margin. When the calculated span is over 1 GHz, it's still coupled to its maximum value, which is 1 GHz.
Couplings	When Res BW is set to Auto, the resolution bandwidth is auto-coupled to span. The ratio of span /RBW is approximately 106:1. When the Res BW is set to Man, bandwidths are entered by the user, and these bandwidths are used regardless of other analyzer settings. Since Span is coupled to Integ BW in the factory default condition, if you change the integration bandwidth setting, the span setting changes by a proportional amount until a limit value is reached. However, the span can be individually set. The minimum value of the span is coupled with the integration bandwidth.

Preset	SA: 3 MHz WCDMA: 7.5 MHz C2K: 1.845 MHz WIMAX OFDMA: 20 MHz 1xEVDO: 2.0MHz DVB-T/H: 10MHz DTMB (CTTB): 10MHz ISDB-T: 10MHz CMMB: 10MHz LTE: 7.5 MHz LTETDD: 7.5 MHz Digital Cable TV: 10MHz WLAN: if Radio Std is 802.11a/g(OFDM/DSSS-OFDM): 30 MHz if Radio Std is 802.11b: 37.5MHz if Radio Std is 802.11n(20MHz): 30 MHz if Radio Std is 802.11n(40MHz): 60 MHz if Radio Std is 802.11ac (20 MHz): 30 MHz if Radio Std is 802.11ac (40 MHz): 60 MHz if Radio Std is 802.11ac (80 MHz): 120 MHz if Radio Std is 802.11ac (160 MHz): 240 MHz if Radio Std is 802.11ac (80 MHz + 80 MHz): 360 MHz
State Saved	Saved in instrument state.
Min	100 Hz
Max	Hardware Maximum Span
Initial S/W Revision	Prior to A.02.00
Modified at S/W Revision	A.02.00, A.03.00, A14.50

## Full Span

Changes the span to show the full frequency range of the spectrum analyzer.

Key Path	Span X Scale
Mode	SA, WCDMA, C2K, WIMAX OFDMA, 1xEVDO, DVB-T/H, DTMB (CTTB), ISDB-T, CMMB, LTE, LTETDD, Digital Cable TV, WLAN, LTEAFDD, LTEATDD
Remote Command	[ :SENSe] :CHPower:FREQuency:SPAN:FULL
Example	CHP:FREQ:SPAN:FULL
Notes	You must be in the Spectrum Analysis mode, W-CDMA mode, cdma2000 mode, DVB-T/H mode, DTMB (CTTB) mode, ISDB-T mode, CMMB mode, Digital Cable TV mode, LTE mode, LTE TDD mode,

	WLAN mode, 1xEVDO mode or WIMAX OFDMA mode to use this command. Use :INSTrument:SElect to set the mode.
Dependencies	For MSR mode, this key is blank. For LTE-Advanced FDD/TDD mode, this key is blank. In order to keep backwards compatible with the legacy LTE FDD/TDD, the scpi command is supported in LTE & LTE-A converged application
Couplings	Selecting full span changes the measurement span value.
Initial S/W Revision	Prior to A.02.00
Modified at S/W Revision	A.02.00, A.03.00

## Last Span

Changes the span to the previous span setting. If no previous span value exists, then the span remains unchanged.

Key Path	Span X Scale
Mode	SA, WCDMA, C2K, WIMAX OFDMA, 1xEVDO, DVB-T/H, DTMB (CTTB), ISDB-T, CMMB, LTE, LTETDD, Digital Cable TV, WLAN, LTEAFDD, LTEATDD
<b>Remote Command</b>	[ :SENSe ] :CHPower :FREQuency:SPAN:PREVIOUS
<b>Example</b>	CHP:FREQ:SPAN:PREV
Notes	You must be in the Spectrum Analysis mode, W-CDMA mode, cdma2000 mode, DVB-T/H mode, DTMB (CTTB) mode, ISDB-T mode, CMMB mode, Digital Cable TV mode, LTE mode, LTE TDD mode, WLAN mode, 1xEVDO mode or WIMAX OFDMA mode to use this command. Use :INSTrument:SElect to set the mode.
Dependencies	For MSR mode, this key is blank. For LTE-Advanced FDD/TDD mode, this key is blank. In order to keep backwards compatible with the legacy LTE FDD/TDD, the scpi command is supported in LTE & LTE-A converged application
Couplings	Selecting last span changes the measurement span value.
Initial S/W Revision	Prior to A.02.00
Modified at S/W Revision	A.02.00, A.03.00, A.14.50

## Sweep/Control

Accesses a menu of functions that enable you to set up and control the sweep time and source for the current measurement. See Key and Command Descriptions – Sweep/Control for more information.

Key Path	Front-panel key
Initial S/W Revision	Prior to A.02.00

### Sweep Time

Selects the length of time that the spectrum analyzer sweeps the displayed frequency span. Additional overhead time, which impacts the sweep rate, is not calculated as part of the sweep time. In fact:

$$\text{sweep rate} = \text{span} / \text{sweep time}$$

$$\text{update rate} = 1 / (\text{sweep time} + \text{overhead})$$

$$\text{sweep cycle time} = \text{sweep time} + \text{overhead}$$

Sweep time is coupled to RBW and VBW, and is impacted by the number of sweep points, so changing those parameters may change the sweep time.

Key Path	Sweep/Control
Mode	SA, WCDMA, C2K, WIMAX OFDMA, 1xEVDO, DVB-T/H, DTMB (CTTB), ISDB-T, CMMB, LTE, LTETDD, Digital Cable TV, WLAN, MSR, LTEAFDD, LTEATDD
Remote Command	[:SENSe]:CHPower:SWEep:TIME <time> [:SENSe]:CHPower:SWEep:TIME? [:SENSe]:CHPower:SWEep:TIME:AUTO OFF ON 0 1 [:SENSe]:CHPower:SWEep:TIME:AUTO?
Example	CHP:SWE:TIME 25ms CHP:SWE:TIME? CHP:SWE:TIME:AUTO OFF CHP:SWE:TIME:AUTO?
Preset	SA, WIMAX OFDMA: Automatically Calculated WCDMA: 1.0 ms CDMA2K: 9.4ms 1xEVDO: 2.66ms DVB-T/H: Automatically Calculated DTMB (CTTB): Automatically Calculated ISDB-T: Automatically Calculated CMMB: Automatically Calculated LTE, MSR: Automatically Calculated LTETDD: Automatically Calculated Digital Cable TV: Automatically Calculated



	WLAN: Automatically Calculated LTEAFDD,LTEATDD:Automatically Calculated
State Saved	Saved in instrument state.
Min	1 ms
Max	4000 s
Initial S/W Revision	Prior to A.02.00
Modified at S/W Revision	A.02.00, A.03.00

## Sweep Setup

Accesses a menu that enables you to set the sweep state for the current measurement.

Key Path	Sweep/Control
Initial S/W Revision	Prior to A.02.00

## Auto Sweep Time Rules

Switches the analyzer between normal and accuracy sweep states.

Setting Auto Sweep Time to Accy results in slower sweep times, usually about three times as long, but yields better amplitude accuracy for CW signals. The instrument amplitude accuracy specifications only apply when Auto Sweep Time is set to Accy.

Additional amplitude errors which occur when Auto Sweep Time is set to Norm are usually well under 0.1 dB, though this is not guaranteed. Because of the faster sweep times and still low errors, Norm is the preferred setting of Auto Sweep Time. Auto Sweep Time is set to Norm on a Preset or Auto Couple. This means that in the Preset or Auto Coupled state, instrument amplitude accuracy specifications do not apply.

Key Path	Sweep/Control, Sweep Setup
Mode	SA, WCDMA, C2K, WIMAX OFDMA, 1xEVDO, DVB-T/H, DTMB (CTTB), ISDB-T, CMMB, LTE, LTEFDD, Digital Cable TV, WLAN, MSR, LTEAFDD, LTEATDD
Remote Command	[ :SENSe ] :CHPower:SWEep:TIME:AUTO:RULEs NORMal ACCuracy [ :SENSe ] :CHPower:SWEep:TIME:AUTO:RULEs?
Example	CHP:SWE:TIME:AUTO:RUL NORM CHP:SWE:TIME:AUTO:RUL?
Notes	In Zero Span, this key is irrelevant and inaccessible (because the whole Sweep Setup menu is grayed out in Zero Span), however its settings can be changed remotely with no error indication. Set to Norm when Auto Couple is pressed or sent remotely

Preset	NORMal
State Saved	Saved in instrument state.
Range	Norm Accy
Initial S/W Revision	Prior to A.02.00
Modified at S/W Revision	A.02.00, A.03.00

## Pause

Pauses a measurement after the current data acquisition is complete. When Paused, the label on the key changes to Resume. Pressing the Resume key resumes the measurement at the point it was at when paused. See Pause/Resume for more details.

Key Path	Sweep/Control
Initial S/W Revision	Prior to A.02.00

## Gate

Accesses a menu that enables you to control the gating function. The Gate functionality is used to view signals best viewed by qualifying them with other events.

Gate setup parameters are the same for all measurements – they do not change as you change measurements. Settings like these are called “Meas Global” and are unaffected by Meas Preset.

Key Path	Sweep/Control
Scope	Meas Global
Readback	The state and method of Gate, as [Off, FFT] or [On, FFT]. Note that for measurements that only support gated FFT, the method is nonetheless read back, but always as FFT.
Initial S/W Revision	Prior to A.02.00

## Gate On/Off

Turns the gate function on and off.

When the Gate Function is on, the selected Gate Method is used along with the gate settings and the signal at the gate source to control the sweep system with the gate signal. Not all measurements allow every type of Gate Methods.

When Gate is on, the annunciation in the measurement bar reflects that it is on and what method is used, as seen in the following "Gate: FFT" annunciator graphic.



Key Path	Sweep/Control, Gate
<b>Remote Command</b>	[ :SENSe ] :SWEep:EGATe [ :STATe ] OFF ON 0 1 [ :SENSe ] :SWEep:EGATe [ :STATe ] ?
<b>Example</b>	SWE:EGAT ON SWE:EGAT?
Dependencies	<p>When in the ACP measurement:</p> <ul style="list-style-type: none"> <li>• When Meas Method is RBW or FAST, this function is unavailable and the key is grayed out.</li> <li>• Whenever Gate is on, Meas Method, RBW or FAST is unavailable and keys for those are grayed out.</li> <li>• When Gate is on, Offset Res BW and Offset Video BW are ignored (if you set these values) and the measurement works as if all Offset Res BW and all Offset Video BW are coupled with the Res BW and the Video BW under the BW menu. When Gate is on, the Offset BW key in the Offset/Limit menu is grayed out.</li> </ul>
Preset	Off LTETDD: On
State Saved	Saved in instrument state
Range	On Off
<b>Backwards Compatibility SCPI</b>	[ :SENSe ] :SWEep:TIME:GATE [ :STATe ] ESA compatibility
Backwards Compatibility Notes	In ESA, Trig Delay (On) and Gate (On) could not be active at the same time.. This dependency does not exist in PSA or in the X-Series.
Initial S/W Revision	Prior to A.02.00

## Gate View On/Off

Turning on Gate View in the Swept SA measurement provides a single-window gate view display..

Turning on Gate View in other measurements shows the split-screen Gate View. In these measurements, when the Gate View is on, the regular view of the current measurement traces and results are reduced vertically to about 70% of the regular height. The Zero Span window, showing the positions of the Gate, is shown between the Measurement Bar and the reduced measurement window. By reducing the height of the measurement window, some of the annotation on the Data Display may not fit and is not shown.

Key Path	Sweep/Control, Gate
<b>Remote Command</b>	[ :SENSe ] :SWEep:EGATe:VIEW ON OFF 1 0 [ :SENSe ] :SWEep:EGATe:VIEW?
<b>Example</b>	SWE:EGAT:VIEW ON turns on the gate view.

Dependencies	<p>In the Swept SA measurement:</p> <p>In Gate View, the regular Acq Time key is grayed out . When pressed, the grayed out key puts up the informational message "Use Gate View Sweep Time in the Gate menu."</p> <p>In the other measurements:</p> <p>When you turn Gate View on, the lower window takes on the current state of the instrument. Upon leaving Gate View, the instrument takes on the state of the lower window.</p> <p>When you turn Gate View on, the upper window Acquisition Time is set to the gate view acquisition time.</p>
Couplings	<p>These couplings apply to the Swept SA measurement:</p> <ul style="list-style-type: none"><li>• When Gate View is turned on, the instrument is set to Zero Span.</li><li>• Gate View automatically turns off whenever a Span other than Zero is selected.</li><li>• Gate View automatically turns off if you press the Last Span key while in Gate View, and the instrument returns to the Span it was in before entering Gate View (even if that is Zero Span).</li><li>• When Gate View is turned on, the sweep time used is the gate view sweep time. This is set according to the rules in section "<a href="#">Gate View Setup</a> " on page 1157</li><li>• When Gate View is turned off, Sweep Time is set to the normal Swept SA measurement sweep time.</li><li>• If Gate View is on and Gate is off, then turning on Gate turns off Gate View.</li></ul>
Preset	OFF
State Saved	Saved in instrument state
Range	On Off
Initial S/W Revision	Prior to A.02.00

A sample of the Gate View screen in the Swept SA measurement is shown in the following graphic :

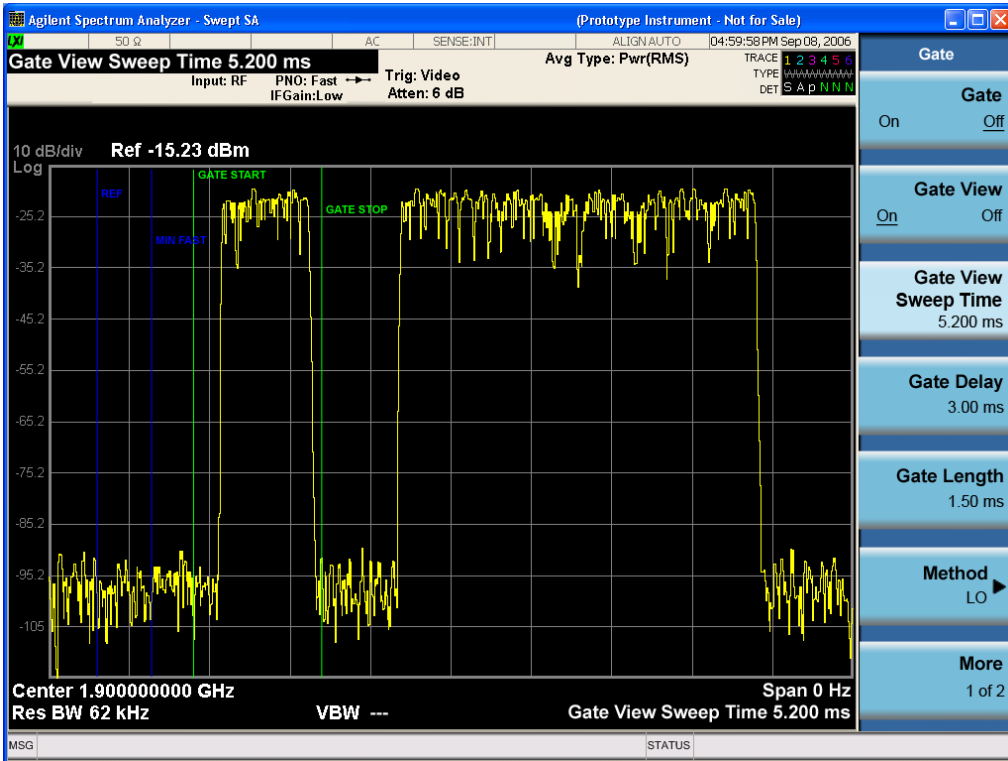

A sample of the Gate View screen in other measurements is shown in the following graphic . This example is for the ACP measurement:

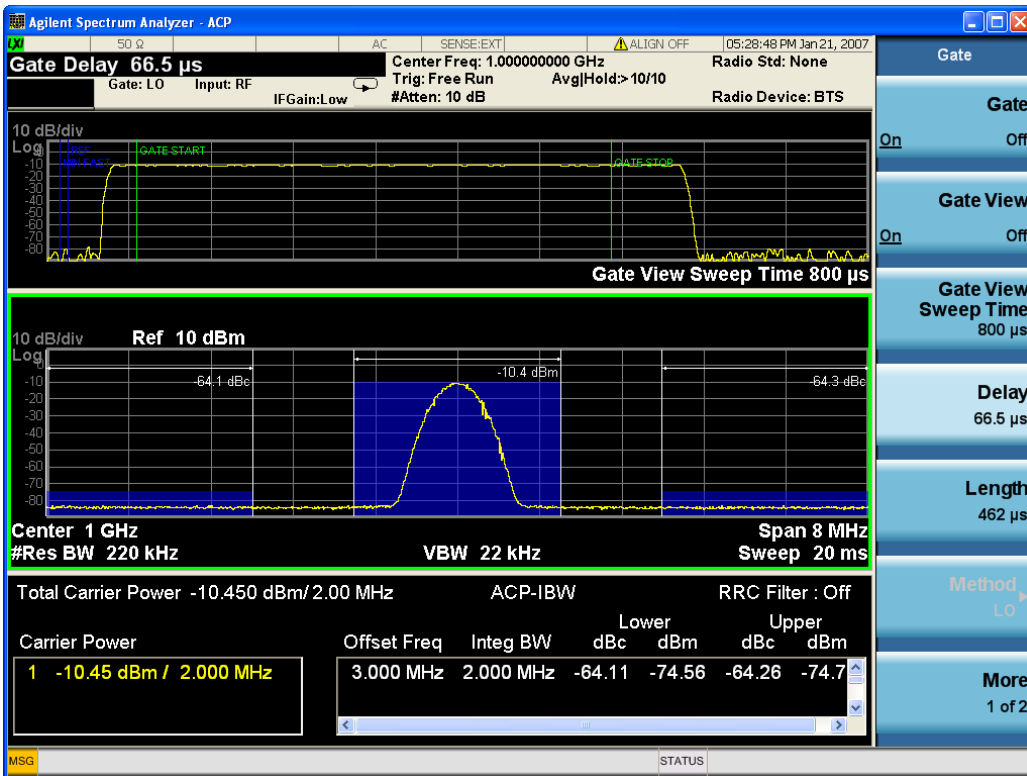

Turning Gate View off returns the analyzer to the Normal measurement view.

In the Swept SA, the normal measurement view is the single-window Swept SA view. When returning to this view, the Swept SA measurement returns to the Span it was in before entering **Gate View** (even if that is Zero Span).

The **Gate View** window is triggered from the Gate Source, with zero trigger delay. Also, when updating the **Gate View** window, the Gate itself must not operate. So it is internally shut off while the gate view window is being updated. For the Swept SA measurement, this means that the Gate is internally shut off whenever the gate view window is displayed. The measurement bar and softkeys continue to show the Trigger source for the main sweep window and give no indication that the Gate is shut off or that the Gate View window is triggered from the Gate Source.

When in **Gate View**, vertical lines are displayed in the Gate View window as follows:

- Green lines are displayed at the gate edges as follows: in Edge Gate, a line is shown for Delay and one for the end of the Gate period, defined by Length. You can adjust the position of the green lines by adjusting the gate length and the gate delay. These lines update in the Gate View window as the active function changes, even if the window is not being updated. In Gated FFT, their location is relative to the left edge of the screen.
- A blue line is displayed showing the delay reference, that is, the reference point for the Gate Delay within the Zero Span window. The blue line represents where (in time) the effective location of the gate start would be if the gate were programmed to zero delay.

- 

## Gate View Setup

Accesses a menu that enables you to setup parameters relevant to the Gate View

Key Path	Sweep/Control, Gate
Scope	Meas Global
Initial S/W Revision	A.10.00

## Gate View Acquisition Time

Controls the acquisition time in the Gate View window. To provide an optimal view of the gate signal, the analyzer initializes Gate View Acq Time based on the current settings of Gate Delay and Gate Length.

Key Path	Sweep/Control, Gate, Gate View Setup
Remote Command	[ :SENSe ] :SWEep:EGATe:TIME <time> [ :SENSe ] :SWEep:EGATe:TIME?
Example	SWE:EGAT:TIME 500 ms
Dependencies	Gate View Acquisition Time is initialized: <ul style="list-style-type: none"> <li>• On Preset (after initializing delay and length).</li> <li>• Every time the Gate Method is set/changed.</li> </ul> <ol style="list-style-type: none"> <li>1. Compute the location of the "gate stop" line, which you know is at time <math>t = t_{min} + \text{GateDelay} +</math></li> </ol>

GateLength.	
Preset	519.3 $\mu$ s WiMAX OFDMA: 5 ms GSM/EDGE: 1 ms
State Saved	Saved in instrument state
Min	100 ns
Max	6000 s
Initial S/W Revision	Prior to A.02.00

### Gate View Start Time

Controls the time at the left edge of the Gate View.

Key Path	Sweep/Control, Gate, Gate View Setup
<b>Remote Command</b>	[ :SENSe ] :SWEep:EGATe:VIEW:STARt <time> [ :SENSe ] :SWEep:EGATe:VIEW:STARt?
<b>Example</b>	SWE:EGAT:VIEW:STAR 10ms
Notes	Units of time are required or no units; otherwise an invalid suffix error message will be generated. See error -131.
Preset	0 ms
State Saved	Saved in instrument state
Min	0
Max	500 ms
Initial S/W Revision	A.10.00

### Gate Delay

Controls the length of time from the time the gate condition goes True until the gate is turned on.

Key Path	Sweep/Control, Gate
<b>Remote Command</b>	[ :SENSe ] :SWEep:EGATe:DELay <time> [ :SENSe ] :SWEep:EGATe:DELay?
<b>Example</b>	SWE:EGAT:DELay 500ms SWE:EGAT:DELay?
Notes	Units of time are required or no units; otherwise an invalid suffix error message will be generated.
Preset	57.7 $\mu$ s WiMAX OFDMA: 71 $\mu$ s GSM/EDGE: 600 $\mu$ s

	WLAN: 500 us WLAN: 36 us
State Saved	Saved in instrument state
Min	0.0 us
Max	100 s
<b>Backwards Compatibility SCPI</b>	[:SENSe]:SWEep:TIME:GATE:DELay ESA compatibility
Initial S/W Revision	Prior to A.02.00

## Gate Length

Controls the length of time that the gate is on after it opens.

Key Path	Sweep/Control, Gate
<b>Remote Command</b>	[:SENSe]:SWEep:EGATe:LENGth <time> [:SENSe]:SWEep:EGATe:LENGth?
<b>Example</b>	SWE:EGAT:LENG 1 SWE:EGAT:LENG?
Notes	Units of time are required or no units; otherwise an invalid suffix error message will be generated.
Preset	461.6 us WiMAX OFDMA: 50 us GSM/EDGE: 200 us WLAN: 1.54 ms WLAN: 32 us
State Saved	Saved in instrument state
Min	100 ns
Max	5 s
<b>Backwards Compatibility SCPI</b>	[:SENSe]:SWEep:TIME:GATE:LENGth ESA compatibility
Initial S/W Revision	Prior to A.02.00

## Gate Source

The menus under the Gate Source key are the same as those under the Trigger key, with the exception that neither Free Run nor Video are available as Gate Source selections. However, a different SCPI command is used to select the Gate Source (see table below) because you may independently set the Gate Source and the Trigger Source.



Any changes to the settings in the setup menus under each Gate Source selection key (for example: Trigger Level, Trigger Delay, etc.) also affect the corresponding settings under the Trigger menu keys. The SCPI commands used for these are the same for Trigger and Gate, since there is only one setting which affects both Gate and Trigger. Example: to set the Trigger Level for External 1 you use the command :TRIG:EXT1:LEV regardless of whether you are using External 1 as a Trigger Source or a Gate Source.

Key Path	Sweep/Control, Gate
Remote Command	[ :SENSe ] :SWEep:EGATe:SOURce EXTernal1   EXTernal2   LINE   FRAME   RFBurst [ :SENSe ] :SWEep:EGATe:SOURce?
Dependencies	In some models, there is no second External input. In these models, the External 2 key is blanked and the EXTernal2 parameter will generate a "Hardware missing; Not available for this model number" error.
Preset	EXTernal 1 GSM/EDGE, MSR: FRAME LTETDD: EXTernal 1When Direction is Downlink, FRAME when Direction is Uplink.
Initial S/W Revision	Prior to A.02.00
Modified at S/W Revision	A.03.00, A.14.00

### Video (IF Envelope)

Pressing this key, when it is not selected, selects the video signal as the trigger. The Video trigger condition is met when the video signal (the filtered and detected version of the input signal, including both RBW and VBW filtering) crosses the video trigger level.

**NOTE**

When the detector selected for all active traces is the average detector, the video signal for triggering does not include any VBW filtering.

The video trigger level is shown as a labeled line on the display. The line is displayed as long as video is the selected trigger source.

Pressing this key, when it is already selected, accesses the video trigger setup functions.

Key Path	Trigger
Example	TRIG:SOUR VID Swept SA measurement TRIG:<meas>:SOUR VID Measurements other than Swept SA
Notes	Log Plot and Spot Frequency measurements do not support Video Trigger
Dependencies	Video trigger is allowed in average detector mode.
State Saved	Saved in instrument state
Status Bits/OPC dependencies	The Status Operation Register bit 5 "Waiting for Trigger" is set at the same time as the Sweeping or Measuring bit is set. It is cleared when the trigger actually occurs (that is, after the trigger event occurs and all the applicable trigger criteria have been met). A corresponding pop-up message ("Waiting for trigger") is generated if no trigger signal appears after approximately 2 sec. This message goes away when a trigger signal appears.

Backwards Compatibility Notes	In the past, the Average detector was not available when Video triggering was on, and consequently, functions that set the detector to average (such as Marker Noise or Band/Intvl Power) were not available when the video trigger was on. Similarly, Video triggering was not available when the detector was Average. In the X-Series, these restrictions are removed.
Initial S/W Revision	Prior to A.02.00

### Trigger Level

Sets a level for the video signal trigger. When the video signal crosses this level, with the chosen slope, the trigger occurs. This level is displayed with a horizontal line only if **Video** is the selected trigger source.

Key Path	Trigger, Video
Remote Command	:TRIGger[:SEquence]:VIDeo:LEVel <ampl> :TRIGger[:SEquence]:VIDeo:LEVel?
Example	TRIG:VID:LEV -40 dBm
Notes	<p>When sweep type = FFT, the video trigger uses the amplitude envelope in a bandwidth wider than the FFT width as a trigger source. This might often be useful, but does not have the same relationship between the displayed trace and the trigger level as in swept triggering.</p> <p>Amplitude Corrections are not taken into account by the Video Trig Level. For example, if you have given yourself effective gain with an amplitude correction factor, the Video Trigger will not fire until you have dropped the trigger line that far below the displayed signal level, rather than simply dropping it down to the displayed signal level.</p> <p>Note that other corrections, specifically External Gain and Ref Level Offset, modify the actual trace data as it is taken and therefore ARE taken into account by Trig Level.</p>
Couplings	This same level is used for the Video trigger source in the Trigger menu and for the Video selection in the Gate Source menu.
Preset	Set the Video Trigger Level -25 dBm on Preset. When the Video Trigger Level becomes the active function, if the value is off screen, set it to either the top or bottom of screen, depending on which direction off screen it was.
State Saved	Saved in instrument state
Min	-170 dBm
Max	+30 dBm
Default Unit	Depends on the current selected Y axis unit
Backwards Compatibility SCPI	:TRIGger[:SEquence]:IF:LEVel :TRIGger[:SEquence]:IF:LEVel?
Backwards Compatibility Notes	This alias is provided for backward compatibility with VSA/PSA comms apps.
Initial S/W Revision	Prior to A.02.00

## Trig Slope

Controls the trigger polarity. It is set positive to trigger on a rising edge and negative to trigger on a falling edge.

Key Path	Trigger, Video
<b>Remote Command</b>	:TRIGger[:SEquence]:VIDeo:SLOPe POSitive NEGative :TRIGger[:SEquence]:VIDeo:SLOPe?
<b>Example</b>	TRIG:VID:SLOP NEG
Preset	POSitive
State Saved	Saved in instrument state
<b>Backwards Compatibility SCPI</b>	:TRIGger[:SEquence]:IF:SLOPe NEGative POSitive :TRIGger[:SEquence]:IF:SLOPe? For backward compatibility with VSA/PSA comms apps
Backwards Compatibility Notes	The legacy :TRIGger[:SEquence]:SLOPe command affects the slopes for the VID, LINE, EXT1, EXT2, and RFB triggers.
Initial S/W Revision	Prior to A.02.00

<b>Remote Command</b>	:TRIGger[:SEquence]:SLOPe POSitive NEGative :TRIGger[:SEquence]:SLOPe?
<b>Example</b>	TRIG:SLOP NEG
Preset	POSitive
State Saved	Saved in instrument state
Backwards Compatibility Notes	In ESA/PSA, the Trigger Slope was global to all triggers. In the X-Series, the slope can be set individually for each Trigger Source. For backward compatibility, the global SLOPe command updates all instances of trigger slope (VID, LINE, EXT1, EXT2, TV, RFB). The query returns the trigger slope setting of the currently selected trigger source.
Initial S/W Revision	Prior to A.02.00

## External 1

Pressing this key, when it is not selected, selects an external input signal as the trigger. A new sweep/measurement will start when the external trigger condition is met using the external 1 input connector on the rear panel.

Pressing this key, when it is already selected, accesses the external 1 trigger setup menu.

Key Path	Trigger
<b>Example</b>	TRIG:SOUR EXT1 Swept SA measurement TRIG:<meas>:SOUR EXT1 Measurements other than Swept SA
Dependencies	Grayed out if in use by Point Trigger in the Source Setup menu. Forced to Free Run if already selected and Point Trigger is set to External 1.

State Saved	Saved in instrument state
Status Bits/OPC dependencies	The Status Operation Register bit 5 "Waiting for Trigger" is set at the same time as the Sweeping or Measuring bit is set. It is cleared when the trigger actually occurs (that is, after the trigger event occurs and all the applicable trigger criteria have been met). A corresponding pop-up message ("Waiting for trigger") is generated if no trigger signal appears after approximately 2 sec. This message goes away when a trigger signal appears.
Initial S/W Revision	Prior to A.02.00

### Trigger Level

Sets the value where the external 1 trigger input will trigger a new sweep/measurement.

Key Path	Trigger, External 1
<b>Remote Command</b>	:TRIGger[:SEquence]:EXTernal:LEVel <level> :TRIGger[:SEquence]:EXTernal:LEVel?
<b>Example</b>	TRIG:EXT1:LEV 0.4 V
Couplings	This same level is used for the Ext1 trigger source in the Trigger menu, for the Ext1 selection in the Periodic Timer sync source (in the Trigger menu and in the Gate Source menu), and also for the Ext1 selection in the Gate Source menu.
Preset	1.2 V
State Saved	Saved in instrument state
Min	-3.5V
Max	3.5V
Default Unit	V
<b>Backwards Compatibility SCPI</b>	:TRIGger[:SEquence]:EXTernal:LEVel For backward compatibility, the parameter EXTernal is mapped to EXTernal1
<b>Backwards Compatibility SCPI</b>	:TRIGger[:SEquence]:FRAMe:EXTernal1:LEVel
Initial S/W Revision	Prior to A.02.00

### Trig Slope

Controls the trigger polarity. It is set positive to trigger on a rising edge and negative to trigger on a falling edge.

Key Path	Trigger, External 1
<b>Remote Command</b>	:TRIGger[:SEquence]:EXTernal:SLOPe POSitive NEGative :TRIGger[:SEquence]:EXTernal:SLOPe?

<b>Example</b>	TRIG:EXT1:SLOP NEG
Couplings	This same slope is used in the Ext1 selection for the trigger source in the Trigger menu and for the period timer sync source (in the Trigger menu and in the Gate Source menu).
Preset	POSitive
State Saved	Saved in instrument state
<b>Backwards Compatibility SCPI</b>	:TRIGger[:SEQuence]:EXTernal:SLOPe For backward compatibility, the parameter EXTernal is mapped to EXTernal1
<b>Backwards Compatibility SCPI</b>	:TRIGger[:SEQuence]:FRAMe:EXTernal1:SLOPe
Backwards Compatibility Notes	The legacy :TRIGger[:SEQuence]:SLOPe command affects the slopes for the VID, LINE, EXT1, EXT2, and RFB triggers.
Initial S/W Revision	Prior to A.02.00

### Zero Span Delay Comp On/Off

In zero span, there is a natural delay in the signal path, which comes from the RBW filter. This is usually desirable, as it allows you to trigger on events and also see those events, because the signal is delayed from the trigger event. However, in some cases it is desirable to eliminate this delay, so that trigger events line up exactly with the zero time point in zero span. You can use the Zero Span Delay Comp On/Off feature to enable or disable zero span delay compensation.

Key Path	Trigger, External 1
<b>Remote Command</b>	:TRIGger[:SEQuence]:EXTernal1:DELAy:COMPensation OFF ON 0 1 :TRIGger[:SEQuence]:EXTernal1:DELAy:COMPensation?
<b>Example</b>	TRIG:EXT1:DEL:COMP ON
Dependencies	No effect except in zero-span, but not locked out in nonzero spans. Blanked in modes that do not support zero-span measurements. If the SCPI command is sent when the key is blanked, an error is returned: -221, "Settings conflict; Feature not supported for this measurement" In analyzers shipping N9060A, this feature requires N9060A-7FP.
Preset	OFF
State Saved	Saved in instrument state
Initial S/W Revision	A.11.00

### External 2

Pressing this key, when it is not selected, selects an external input signal as the trigger. A new sweep/measurement will start when the external trigger condition is met using the external 2 input connector. The external trigger 2 input connector is on the rear panel.

Pressing this key, when it is already selected, accesses the external 2 trigger setup menu.

Key Path	Trigger
<b>Example</b>	TRIG:SOUR EXT2 Swept SA measurement TRIG:<meas>:SOUR EXT2 Measurements other than Swept SA
Dependencies	In some models, there is no second External input. In these models, the External 2 key is blanked and the EXTERNAL2 parameter will generate a "Hardware missing; Not available for this model number" message. Grayed out if in use by Point Trigger in the Source Setup menu. Forced to Free Run if already selected and Point Trigger is set to External 2.
State Saved	Saved in instrument state
Status Bits/OPC dependencies	The Status Operation Register bit 5 "Waiting for Trigger" is set at the same time as the Sweeping or Measuring bit is set. It is cleared when the trigger actually occurs (that is, after the trigger event occurs and all the applicable trigger criteria have been met). A corresponding pop-up message ("Waiting for trigger") is generated if no trigger signal appears after approximately 2 sec. This message goes away when a trigger signal appears.
Initial S/W Revision	Prior to A.02.00
Modified at S/W Revision	A.03.00

### Trigger Level

Sets the value where the external 2 trigger input will trigger a new sweep/measurement.

Key Path	Trigger, External 2
<b>Remote Command</b>	:TRIGger[:SEquence]:EXTernal2:LEVel :TRIGger[:SEquence]:EXTernal2:LEVel?
<b>Example</b>	TRIG:EXT2:LEV 1.1 V
Couplings	This same level is used for the Ext2 trigger source in the Trigger menu, for the Ext2 selection in the Periodic Timer sync source (in the Trigger menu and in the Gate Source menu), and also for the Ext2 selection in the Gate Source menu.
Preset	1.2 V
State Saved	Saved in instrument state
Min	-3.5V
Max	3.5V
Default Unit	V
<b>Backwards Compatibility SCPI</b>	:TRIGger[:SEquence]:FRAME:EXTernal2:LEVel
Initial S/W Revision	Prior to A.02.00

## Trig Slope

Controls the trigger polarity. It is set positive to trigger on a rising edge and negative to trigger on a falling edge.

Key Path	Trigger, External 2
<b>Remote Command</b>	:TRIGger[:SEquence]:EXTernal2:SLOPe POSitive NEGative :TRIGger[:SEquence]:EXTernal2:SLOPe?
<b>Example</b>	TRIG:EXT2:SLOP NEG
Couplings	This same slope is used in the Ext2 selection for the trigger source in the Trigger menu and for the period timer sync source (in the Trigger menu and in the Gate Source menu).
Preset	POSitive
State Saved	Saved in instrument state
<b>Backwards Compatibility SCPI</b>	:TRIGger[:SEquence]:FRAMe:EXTernal2:SLOPe
Backwards Compatibility Notes	The legacy :TRIGger[:SEquence]:SLOPe command affects the slopes for the VID, LINE, EXT1, EXT2, and RFB triggers.
Initial S/W Revision	Prior to A.02.00

## Zero Span Delay Comp On/Off

In zero span, there is a natural delay in the signal path, which comes from the RBW filter. This is usually desirable, as it allows you to trigger on events and also see those events, because the signal is delayed from the trigger event. However, in some cases it is desirable to eliminate this delay, so that trigger events line up exactly with the zero time point in zero span. You can use the Zero Span Delay Comp On/Off feature to enable or disable zero span delay compensation.

Key Path	Trigger, External 2
<b>Remote Command</b>	:TRIGger[:SEquence]:EXTernal2:DELAy:COMPensation OFF ON 0 1 :TRIGger[:SEquence]:EXTernal2:DELAy:COMPensation?
<b>Example</b>	TRIG:EXT2:DEL:COMP ON
Dependencies	No effect except in zero-span, but not locked out in nonzero spans. Blanked in modes that do not support zero-span measurements. If the SCPI command is sent when the key is blanked, an error is returned: -221, "Settings conflict; Feature not supported for this measurement" In analyzers shipping N9060A, this feature requires N9060A-7FP.
Preset	OFF
State Saved	Saved in instrument state
Initial S/W Revision	A.11.00

## RF Burst

Pressing this key, when it is not selected, selects the RF Burst as the trigger. A new sweep/measurement will start when an RF burst envelope signal is identified from the signal at the RF Input connector. Pressing this key, when it is already selected, accesses the RF Burst trigger setup menu.

In some models, a variety of burst trigger circuitry is available, resulting in various available burst trigger bandwidths. The analyzer automatically chooses the appropriate trigger path based on the hardware configuration and other settings of the analyzer.

<b>Key Path</b>	<b>Trigger</b>
<b>Example</b>	TRIG:SOUR RFB Swept SA measurement TRIG:< meas>:SOUR RFB Measurements other than Swept SA
<b>State Saved</b>	Saved in instrument state
<b>Status Bits/OPC dependencies</b>	The Status Operation Register bit 5 "Waiting for Trigger" is set at the same time as the Sweeping or Measuring bit is set. It is cleared when the trigger actually occurs (that is, after the trigger event occurs and all the applicable trigger criteria have been met). A corresponding pop-up message ("Waiting for trigger") is generated if no trigger signal appears after approximately 2 sec. This message goes away when a trigger signal appears.
<b>Backwards Compatibility Notes</b>	The legacy command: :TRIGger[:SEQuence]:RFBurst:FSElectivity[:STATe] OFF ON 0 1 is not supported in the X-Series, as the hardware to do Frequency Selective burst triggers does not exist in X-Series.
<b>Initial S/W Revision</b>	Prior to A.02.00
<b>Modified at S/W Revision</b>	A.04.00

## Absolute Trigger Level

Sets the absolute trigger level for the RF burst envelope.

When using the External Mixing path, the Absolute Trigger Level is uncalibrated because the factory default was set to accommodate the expected IF levels for the RF path.

<b>Key Path</b>	<b>Trigger, RF Burst</b>
<b>Scope</b>	Meas Global
<b>Remote Command</b>	:TRIGger[:SEQuence]:RFBurst:LEVel:ABSolute <ampl> :TRIGger[:SEQuence]:RFBurst:LEVel:ABSolute?
<b>Example</b>	TRIG:RFB:LEV:ABS 10 dBm sets the trigger level of the RF burst envelope signal to the absolute level of 10 dBm
<b>Notes</b>	Sending this command does not switch the setting from relative to absolute; to switch it you need to send the :TRIGger[:SEQuence]:RFBurst:LEVel:TYPE command, below. Amplitude Corrections are not taken into account by the Absolute Trigger Level. For example, if you have given yourself effective gain with an amplitude correction factor, the Absolute Trigger will not fire until you have set the trigger level that far below the displayed signal level, rather than simply to



	the displayed signal level. This is only true for Amplitude Corrections, not External Gain or Ref Level Offset functions. If mode is Bluetooth, the default value is -50 dBm.
Couplings	This same level is used for the RF Burst trigger source in the Trigger menu, for the RF Burst selection in the Periodic Timer sync source (in the Trigger menu and in the Gate Source menu), and also for the RF Burst selection in the Gate Source menu
Preset	-20 dBm
State Saved	Saved in instrument state
Min	-200 dBm
Max	100 dBm
Default Unit	depends on the current selected Y-Axis unit
<b>Backwards Compatibility SCPI</b>	:TRIGger[:SEquence]:FRAMe:RFBurst:LEVel:ABSolute
Initial S/W Revision	Prior to A.02.00
Modified at S/W Revision	A.04.00

Key Path	Trigger, RF Burst
<b>Remote Command</b>	:TRIGger[:SEquence]:RFBurst:LEVel:TYPE ABSolute RELative :TRIGger[:SEquence]:RFBurst:LEVel:TYPE?
<b>Example</b>	TRIG:RFB:LEV:TYPE REL sets the trigger level type of the RF burst trigger to Relative.
Preset	ABSolute
State Saved	Saved in instrument state
Initial S/W Revision	Prior to A.02.00
Modified at S/W Revision	A.04.00

### Relative Trigger Level

Sets the relative trigger level for the RF burst envelope.

In some models, the relative burst trigger function is implemented in hardware. In other models, without the advanced triggering hardware required, the relative burst trigger function is implemented in software in some measurements, and is unavailable in other measurements.

When implemented in software, the relative RF Burst trigger function is implemented as follows:

1. The measurement starts with the absolute RF Burst trigger setting. If it cannot get a trigger with that level, auto trigger fires and the acquisition starts anyway. After the acquisition, the measurement searches for the peak in the acquired waveform and saves it.

2. Now, in the next cycle of the measurement, the measurement determines a new absolute RF Burst level based on the peak value from the first measurement and the Relative RF Burst Trigger Level (always 0 or negative dB) set by the user. The following formula is used:
  3. absolute RF Burst level = peak level of the previous acquisition + relative RF Burst level
  4. If the new absolute RF Burst level differs from the previous by more than 0.5 dB, the new level is sent to the hardware; otherwise it is not updated (to avoid slowing down the acquisition)
- Steps 2 and 3 repeat for subsequent measurements.

Key Path	Trigger, RF Burst
Scope	Meas Global
<b>Remote Command</b>	:TRIGger[:SEquence]:RFBurst:LEVel:RELative <rel_ampl> :TRIGger[:SEquence]:RFBurst:LEVel:RELative?
<b>Example</b>	TRIG:RFB:LEV:REL -10 dB sets the trigger level of the RF burst envelope signal to the relative level of -10 dB
Notes	Sending this command does not switch the setting from absolute to relative; to switch it you need to send the :TRIGger[:SEquence]:RFBurst:LEVel:TYPE command, above. The relative trigger level is not available in some measurements. In those measurements the RELative parameter, and the :TRIGger[:SEquence]:RFBurst:LEVel:TYPE command (above), will generate an error if sent.
Dependencies	This key is grayed out and Absolute Trigger Level selected if the required hardware is not present in your analyzer and the current measurement does not support Relative triggering.
Preset	-6 dB GSM: -25 dB
State Saved	Saved in instrument state
Min	-45 dB
Max	0 dB
Default Unit	dB or dBc
<b>Backwards Compatibility SCPI</b>	:TRIGger[:SEquence]:RFBurst:LEVel This legacy command is aliased to :TRIGger[:SEquence]:RFBurst:LEVel:RELative because the PSA had ONLY relative burst triggering
Initial S/W Revision	Prior to A.02.00
Modified at S/W Revision	A.04.00

### Trigger Slope

It is set positive to trigger on a rising edge and negative to trigger on a falling edge.

Key Path	Trigger, RF Burst
<b>Remote Command</b>	:TRIGger[:SEquence]:RFBurst:SLOPe POSitive NEGative :TRIGger[:SEquence]:RFBurst:SLOPe?

<b>Example</b>	TRIG:RFB:SLOP NEG
Couplings	This same slope is used in the RF Burst selection for the trigger source in the Trigger menu and for the period timer sync source (in the Trigger menu and in the Gate Source menu).
Preset	POSitive
State Saved	Saved in instrument state
<b>Backwards Compatibility SCPI</b>	:TRIGger[:SEQuence]:FRAMe:RFBurst:SLOPe
Backwards Compatibility Notes	The legacy :TRIGger[:SEQuence]:SLOPe command affects the slopes for the VID, LINE, EXT1, EXT2, and RFB triggers.
Initial S/W Revision	Prior to A.02.00

### Periodic Timer (Frame Trigger)

Pressing this key, when it is not selected, selects the internal periodic timer signal as the trigger. Triggering occurrences are set by the **Period** parameter, which is modified by the **Sync Source** and **Offset**. Pressing this key, when it is already selected, accesses the periodic timer trigger setup functions.

If you do not have a sync source selected (it is Off), then the internal timer will not be synchronized with any external timing events.

Key Path	Trigger
<b>Example</b>	TRIG:SOUR FRAM      Swept SA measurement TRIG:<meas>:SOUR FRAM      Measurements other than Swept SA
State Saved	Saved in instrument state
Readback	[Sync: <value of Sync Source>], for example, [Sync: External 1]
Status Bits/OPC dependencies	The Status Operation Register bit 5 "Waiting for Trigger" is set at the same time as the Sweeping or Measuring bit is set. It is cleared when the trigger actually occurs (that is, after the trigger event occurs and all the applicable trigger criteria have been met). A corresponding pop-up message ("Waiting for trigger") is generated if no trigger signal appears after approximately 2 sec. This message goes away when a trigger signal appears.
Initial S/W Revision	Prior to A.02.00

### Periodic Timer Triggering:

This feature selects the internal periodic timer signal as the trigger. Trigger occurrences are set by the **Periodic Timer** parameter, which is modified by the **Sync Source** and **Offset**.

The figure below shows the action of the periodic timer trigger. Before reviewing the figure, we'll explain some uses for the periodic trigger.

A common application is measuring periodic burst RF signals for which a trigger signal is not easily available. For example, we might be measuring a TDMA radio which bursts every 20 ms. Let's assume that the 20 ms period is very consistent. Let's also assume that we do not have an external trigger source

available that is synchronized with the period, and that the signal-to-noise ratio of the signal is not high enough to provide a clean RF burst trigger at all of the analysis frequencies. For example, we might want to measure spurious transmissions at an offset from the carrier that is larger than the bandwidth of the RF burst trigger. In this application, we can set the Periodic Timer to a 20.00 ms period and adjust the offset from that timer to position our trigger just where we want it. If we find that the 20.00 ms is not exactly right, we can adjust the period slightly to minimize the drift between the period timer and the signal to be measured.

A second way to use this feature would be to use **Sync Source** temporarily, instead of **Offset**. In this case, we might tune to the signal in a narrow span and use the RF Burst trigger to synchronize the periodic timer. Then we would turn the sync source off so that it would not miss-trigger. Miss-triggering can occur when we are tuned so far away from the RF burst trigger that it is no longer reliable.

A third example would be to synchronize to a signal that has a reference time element of much longer period than the period of interest. In some CDMA applications, it is useful to look at signals with a short periodicity, by synchronizing that periodicity to the "even-second clock" edge that happens every two seconds. Thus, we could connect the even-second clock trigger to Ext1 and use then Ext1 as the sync source for the periodic timer.

The figure below illustrates this third example. The top trace represents the even-second clock. It causes the periodic timer to synchronize with the leading edge shown. The analyzer trigger occurs at a time delayed by the accumulated offset from the period trigger event. The periodic timer continues to run, and triggers continue to occur, with a periodicity determined by the analyzer time base. The timer output (labeled "late event") will drift away from its ideal time due to imperfect matching between the time base of the signal being measured and the time base of the analyzer, and also because of imperfect setting of the period parameter. But the synchronization is restored on the next even-second clock event. ("Accumulated offset" is described in the in the **Offset** function section.)

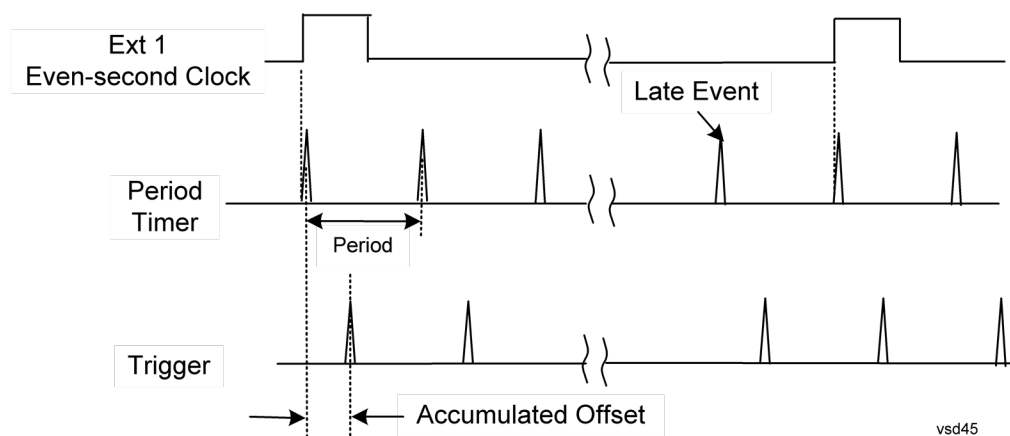

### Period

Sets the period of the internal periodic timer clock. For digital communications signals, this is usually set to the frame period of your current input signal. In the case that sync source is not set to OFF, and the external sync source rate is changed for some reason, the periodic timer is synchronized at the every external synchronization pulse by resetting the internal state of the timer circuit.

Key Path	Trigger, Periodic Timer
Remote Command	:TRIGger[:SEquence]:FRAME:PERiod <time>

	:TRIGger[:SEquence]:FRAMe:PERiod?
<b>Example</b>	TRIG:FRAM:PER 100 ms
Dependencies	The invalid data indicator turns on when the period is changed, until the next sweep/measurement completes.
Couplings	The same period is used in the Gate Source selection of the period timer.
Preset	20 ms GSM: 4.615383
State Saved	Saved in instrument state
Min	100.000 ns
Max	559.0000 ms
Default Unit	S
Initial S/W Revision	Prior to A.02.00

### Offset

Adjusts the accumulated offset between the periodic timer events and the trigger event. Adjusting the accumulated offset is different than setting an offset, and requires explanation.

The periodic timer is usually not synchronized with any external events, so the timing of its output events has no absolute meaning. Since the timing relative to external events (RF signals) is important, you need to be able to adjust (offset) it. However, you have no direct way to see when the periodic timer events occur. All that you can see is the trigger timing. When you want to adjust the trigger timing, you will be changing the internal offset between the periodic timer events and the trigger event. Because the absolute value of that internal offset is unknown, we will just call that the accumulated offset. Whenever the Offset parameter is changed, you are changing that accumulated offset. You can reset the displayed offset using Reset Offset Display. Changing the display does not change the value of the accumulated offset, and you can still make additional changes to accumulated offset.

To avoid ambiguity, we define that an increase in the "offset" parameter, either from the knob or the SCPI adjust command, serves to delay the timing of the trigger event.

Key Path	Trigger, Periodic Timer
<b>Remote Command</b>	:TRIGger[:SEquence]:FRAMe:OFFSet <time> :TRIGger[:SEquence]:FRAMe:OFFSet?
<b>Example</b>	TRIG:FRAM:OFFS 1.2 ms
Notes	The front panel interface (for example, the knob), and this command, adjust the accumulated offset, which is shown on the active function display. However, the actual amount sent to the hardware each time the offset is updated is the delta value, that is, the current accumulated offset value minus the previous accumulated offset value. Note that the accumulated offset value is essentially arbitrary; it represents the accumulated offset from the last time the offset was zeroed (with the Reset Offset Display key).  Note that this command does not change the period of the trigger waveform. Note also that Offset is used only when the sync source is set to OFF, otherwise delay is used, see section "Trig Delay" on page 275.

	An increase in the "offset" parameter, either from the knob or the SCPI adjust command, serves to delay the timing of the trigger event.
Notes	When the SCPI command is sent the value shown on the key (and the Active Function, if this happens to be the active function) is updated with the new value. However, the actual amount sent to the hardware is the delta value, that is, the current accumulated offset value minus the previous accumulated offset value.  The SCPI query simply returns the value currently showing on the key.
Dependencies	The invalid data indicator turns on when the offset is changed, until the next sweep/measurement completes.
Couplings	The same offset is used in the Gate Source selection of the period timer.
Preset	0 s
State Saved	Saved in instrument state
Min	-10.000 s
Max	10.000 s
Default Unit	S
Initial S/W Revision	Prior to A.02.00

#### Offset Adjust (Remote Command Only)

This remote command does not work at all like the related front panel keys. This command lets you advance the phase of the frame trigger by the amount you specify.

It does not change the period of the trigger waveform. If the command is sent multiple times, it advances the phase of the frame trigger an additional amount each time it is sent. Negative numbers are permitted.

<b>Remote Command</b>	:TRIGger[:SEquence]:FRAMe:ADJust <time>
<b>Example</b>	TRIG:FRAM:ADJ 1.2 ms
Notes	Note also that Offset is used only when the sync source is set to OFF, otherwise delay is used, see section <a href="#">"Trig Delay" on page 275</a>  An increase in the "offset" parameter, either from the knob or the SCPI adjust command, serves to delay the timing of the trigger event.
Notes	The front panel interface (for example, the knob) and the :TRIG:FRAM:OFFS command adjust the accumulated offset, which is shown on the active function display. However, the actual amount sent to the hardware is the delta value, that is, the current offset value minus the previous offset value.  When the SCPI command is sent the value shown on the key (and the Active Function, if this happens to be the active function) is updated by increasing it (or decreasing it if the value sent is negative) by the amount specified in the SCPI command.  This is a "command only" SCPI command, with no query.
Dependencies	The invalid data indicator turns on when the offset is changed, until the next sweep/measurement completes.
Couplings	The same offset is used in the Gate Source selection of the period timer.
Preset	0 s

State Saved	Saved in instrument state
Min	-10.000 s
Max	10.000 s
Default Unit	S
Initial S/W Revision	Prior to A.02.00

### Reset Offset Display

Resets the value of the periodic trigger offset display setting to 0.0 seconds. The current displayed trigger location may include an offset value defined with the Offset key. Pressing this key redefines the currently displayed trigger location as the new trigger point that is 0.0 s offset. The Offset key can then be used to add offset relative to this new timing.

Key Path	Trigger, Periodic Timer
<b>Remote Command</b>	:TRIGger[:SEquence]:FRAMe:OFFSet:DISPlay:RESet
<b>Example</b>	TRIG:FRAM:OFFS:DISP:RES
Initial S/W Revision	Prior to A.02.00

### Sync Source

Selects a signal source for you to synchronize your periodic timer trigger to, otherwise you are triggering at some arbitrary location in the frame. Synchronization reduces the precision requirements on the setting of the period.

For convenience you may adjust the level and slope of the selected sync source in a conditional branch setup menu accessed from the Sync Source menu. Note that these settings match those in the **Trigger** and **Gate Source** menus; that is, each trigger source has only one value of level and slope, regardless of which menu it is accessed from.

Key Path	Trigger, Periodic Timer
<b>Remote Command</b>	:TRIGger[:SEquence]:FRAMe:SYNC EXTernal1   EXTernal2   RFBurst   OFF :TRIGger[:SEquence]:FRAMe:SYNC?
<b>Example</b>	TRIG:FRAM:SYNC EXT2
Dependencies	In some models, there is no second External input. In these models, the External 2 key is blanked and the EXTernal2 parameter will generate a "Hardware missing; Not available for this model number" message.
Preset	Off GSM/EDGE, MSR,LTE,LTETDD: RFBurst
State Saved	Saved in instrument state
Readback	The current setting is read back to this key and it is also Readback to the previous Periodic Timer trigger key.

<b>Backwards Compatibility SCPI</b>	:TRIGger[:SEquence]:FRAMe:SYNC EXTernal
Initial S/W Revision	Prior to A.02.00
Modified at S/W Revision	A.03.00, A.14.00

### Off

Turns off the sync source for your periodic trigger. With the sync source off, the timing will drift unless the signal source frequency is locked to the analyzer frequency reference.

<b>Key Path</b>	Trigger, Periodic Timer, Sync Source
<b>Example</b>	TRIG:FRAM:SYNC OFF
Readback	Off
Initial S/W Revision	Prior to A.02.00

### External 1

Pressing this key, when it is not selected, selects an external input signal as the trigger. A new sweep/measurement will start when the external trigger condition is met using the external 1 input connector on the rear panel.

Pressing this key, when it is already selected, accesses the external 1 trigger setup menu.

<b>Key Path</b>	Trigger
<b>Example</b>	TRIG:SOUR EXT1 Swept SA measurement TRIG:<meas>:SOUR EXT1 Measurements other than Swept SA
<b>Dependencies</b>	Grayed out if in use by Point Trigger in the Source Setup menu. Forced to Free Run if already selected and Point Trigger is set to External 1.
<b>State Saved</b>	Saved in instrument state
<b>Status Bits/OPC dependencies</b>	The Status Operation Register bit 5 "Waiting for Trigger" is set at the same time as the Sweeping or Measuring bit is set. It is cleared when the trigger actually occurs (that is, after the trigger event occurs and all the applicable trigger criteria have been met). A corresponding pop-up message ("Waiting for trigger") is generated if no trigger signal appears after approximately 2 sec. This message goes away when a trigger signal appears.
Initial S/W Revision	Prior to A.02.00

### Trigger Level

Sets the value where the external 1 trigger input will trigger a new sweep/measurement.



Key Path	Trigger, External 1
<b>Remote Command</b>	:TRIGger[:SEquence]:EXTernal1:LEVel <level> :TRIGger[:SEquence]:EXTernal1:LEVel?
<b>Example</b>	TRIG:EXT1:LEV 0.4 V
Couplings	This same level is used for the Ext1 trigger source in the Trigger menu, for the Ext1 selection in the Periodic Timer sync source (in the Trigger menu and in the Gate Source menu), and also for the Ext1 selection in the Gate Source menu.
Preset	1.2 V
State Saved	Saved in instrument state
Min	-3.5V
Max	3.5V
Default Unit	V
<b>Backwards Compatibility SCPI</b>	:TRIGger[:SEquence]:EXTernal:LEVel For backward compatibility, the parameter EXTernal is mapped to EXTernal1
<b>Backwards Compatibility SCPI</b>	:TRIGger[:SEquence]:FRAMe:EXTernal1:LEVel
Initial S/W Revision	Prior to A.02.00

### Trig Slope

Controls the trigger polarity. It is set positive to trigger on a rising edge and negative to trigger on a falling edge.

Key Path	Trigger, External 1
<b>Remote Command</b>	:TRIGger[:SEquence]:EXTernal1:SLOPe POSitive NEGative :TRIGger[:SEquence]:EXTernal1:SLOPe?
<b>Example</b>	TRIG:EXT1:SLOP NEG
Couplings	This same slope is used in the Ext1 selection for the trigger source in the Trigger menu and for the period timer sync source (in the Trigger menu and in the Gate Source menu).
Preset	POSitive
State Saved	Saved in instrument state
<b>Backwards Compatibility SCPI</b>	:TRIGger[:SEquence]:EXTernal:SLOPe For backward compatibility, the parameter EXTernal is mapped to EXTernal1
<b>Backwards Compatibility SCPI</b>	:TRIGger[:SEquence]:FRAMe:EXTernal1:SLOPe
Backwards Compatibility Notes	The legacy :TRIGger[:SEquence]:SLOPe command affects the slopes for the VID, LINE, EXT1, EXT2, and RFB triggers.
Initial S/W Revision	Prior to A.02.00

## External 2

Pressing this key, when it is not selected, selects an external input signal as the trigger. A new sweep/measurement will start when the external trigger condition is met using the external 2 input connector. The external trigger 2 input connector is on the rear panel.

Pressing this key, when it is already selected, accesses the external 2 trigger setup menu.

Key Path	Trigger
<b>Example</b>	TRIG:SOUR EXT2 Swept SA measurement TRIG:<meas>:SOUR EXT2 Measurements other than Swept SA
Dependencies	In some models, there is no second External input. In these models, the External 2 key is blanked and the EXTernal2 parameter will generate a "Hardware missing; Not available for this model number" message. Grayed out if in use by Point Trigger in the Source Setup menu. Forced to Free Run if already selected and Point Trigger is set to External 2.
State Saved	Saved in instrument state
Status Bits/OPC dependencies	The Status Operation Register bit 5 "Waiting for Trigger" is set at the same time as the Sweeping or Measuring bit is set. It is cleared when the trigger actually occurs (that is, after the trigger event occurs and all the applicable trigger criteria have been met). A corresponding pop-up message ("Waiting for trigger") is generated if no trigger signal appears after approximately 2 sec. This message goes away when a trigger signal appears.
Initial S/W Revision	Prior to A.02.00
Modified at S/W Revision	A.03.00

## Trigger Level

Sets the value where the external 2 trigger input will trigger a new sweep/measurement.

Key Path	Trigger, External 2
<b>Remote Command</b>	:TRIGger[:SEquence]:EXTernal2:LEVel :TRIGger[:SEquence]:EXTernal2:LEVel?
<b>Example</b>	TRIG:EXT2:LEV 1.1 V
Couplings	This same level is used for the Ext2 trigger source in the Trigger menu, for the Ext2 selection in the Periodic Timer sync source (in the Trigger menu and in the Gate Source menu), and also for the Ext2 selection in the Gate Source menu.
Preset	1.2 V
State Saved	Saved in instrument state
Min	-3.5V
Max	

	3.5V
Default Unit	V
<b>Backwards Compatibility SCPI</b>	:TRIGger[:SEquence]:FRAMe:EXTernal2:LEVel
Initial S/W Revision	Prior to A.02.00

### Trig Slope

Controls the trigger polarity. It is set positive to trigger on a rising edge and negative to trigger on a falling edge.

Key Path	Trigger, External 2
<b>Remote Command</b>	:TRIGger[:SEquence]:EXTernal2:SLOPe POSitive NEGative :TRIGger[:SEquence]:EXTernal2:SLOPe?
<b>Example</b>	TRIG:EXT2:SLOP NEG
Couplings	This same slope is used in the Ext2 selection for the trigger source in the Trigger menu and for the period timer sync source (in the Trigger menu and in the Gate Source menu).
Preset	POSitive
State Saved	Saved in instrument state
<b>Backwards Compatibility SCPI</b>	:TRIGger[:SEquence]:FRAMe:EXTernal2:SLOPe
Backwards Compatibility Notes	The legacy :TRIGger[:SEquence]:SLOPe command affects the slopes for the VID, LINE, EXT1, EXT2, and RFB triggers.
Initial S/W Revision	Prior to A.02.00

### RF Burst

Pressing this key, when it is not selected, selects the RF Burst as the trigger. A new sweep/measurement will start when an RF burst envelope signal is identified from the signal at the RF Input connector. Pressing this key, when it is already selected, accesses the RF Burst trigger setup menu.

In some models, a variety of burst trigger circuitry is available, resulting in various available burst trigger bandwidths. The analyzer automatically chooses the appropriate trigger path based on the hardware configuration and other settings of the analyzer.

Key Path	Trigger
<b>Example</b>	TRIG:SOUR RFB Swept SA measurement TRIG:<meas>:SOUR RFB Measurements other than Swept SA
State Saved	Saved in instrument state
Status Bits/OPC dependencies	The Status Operation Register bit 5 "Waiting for Trigger" is set at the same time as the Sweeping or Measuring bit is set. It is cleared when the trigger actually occurs (that is, after the trigger event)

	occurs and all the applicable trigger criteria have been met). A corresponding pop-up message ("Waiting for trigger") is generated if no trigger signal appears after approximately 2 sec. This message goes away when a trigger signal appears.
Backwards Compatibility Notes	The legacy command: :TRIGger[:SEquence]:RFBurst:FSElectivity[:STATe] OFF ON 0 1 is not supported in the X-Series, as the hardware to do Frequency Selective burst triggers does not exist in X-Series.
Initial S/W Revision	Prior to A.02.00
Modified at S/W Revision	A.04.00

### Absolute Trigger Level

Sets the absolute trigger level for the RF burst envelope.

When using the External Mixing path, the Absolute Trigger Level is uncalibrated because the factory default was set to accommodate the expected IF levels for the RF path.

Key Path	Trigger, RF Burst
Scope	Meas Global
Remote Command	:TRIGger[:SEquence]:RFBurst:LEVel:ABSolute <ampl> :TRIGger[:SEquence]:RFBurst:LEVel:ABSolute?
Example	TRIG:RFB:LEV:ABS 10 dBm sets the trigger level of the RF burst envelope signal to the absolute level of 10 dBm
Notes	Sending this command does not switch the setting from relative to absolute; to switch it you need to send the :TRIGger[:SEquence]:RFBurst:LEVel:TYPE command, below.  Amplitude Corrections are not taken into account by the Absolute Trigger Level. For example, if you have given yourself effective gain with an amplitude correction factor, the Absolute Trigger will not fire until you have set the trigger level that far below the displayed signal level, rather than simply to the displayed signal level. This is only true for Amplitude Corrections, not External Gain or Ref Level Offset functions.  If mode is Bluetooth, the default value is -50 dBm.
Couplings	This same level is used for the RF Burst trigger source in the Trigger menu, for the RF Burst selection in the Periodic Timer sync source (in the Trigger menu and in the Gate Source menu), and also for the RF Burst selection in the Gate Source menu
Preset	-20 dBm
State Saved	Saved in instrument state
Min	-200 dBm
Max	100 dBm
Default Unit	depends on the current selected Y-Axis unit
Backwards Compatibility SCPI	:TRIGger[:SEquence]:FRAME:RFBurst:LEVel:ABSolute
Initial S/W Revision	Prior to A.02.00
Modified at S/W Revision	A.04.00

Key Path	Trigger, RF Burst
Remote Command	:TRIGger[:SEquence]:RFBurst:LEVel:TYPE ABSolute RELative :TRIGger[:SEquence]:RFBurst:LEVel:TYPE?
Example	TRIG:RFB:LEV:TYPE REL sets the trigger level type of the RF burst trigger to Relative.
Preset	ABSolute
State Saved	Saved in instrument state
Initial S/W Revision	Prior to A.02.00
Modified at S/W Revision	A.04.00

### Trigger Slope

It is set positive to trigger on a rising edge and negative to trigger on a falling edge.

Key Path	Trigger, RF Burst
Remote Command	:TRIGger[:SEquence]:RFBurst:SLOPe POSitive NEGative :TRIGger[:SEquence]:RFBurst:SLOPe?
Example	TRIG:RFB:SLOP NEG
Couplings	This same slope is used in the RF Burst selection for the trigger source in the Trigger menu and for the period timer sync source (in the Trigger menu and in the Gate Source menu).
Preset	POSitive
State Saved	Saved in instrument state
Backwards Compatibility SCPI	:TRIGger[:SEquence]:FRAMe:RFBurst:SLOPe
Backwards Compatibility Notes	The legacy :TRIGger[:SEquence]:SLOPe command affects the slopes for the VID, LINE, EXT1, EXT2, and RFB triggers.
Initial S/W Revision	Prior to A.02.00

### Sync Holdoff

Sync Holdoff specifies the duration that the sync source signal must be kept false before the transition to true to be recognized as the sync timing. The periodic timer phase is aligned when the sync source signal becomes true, after the Holdoff time is satisfied.

A holdoff of 2 ms will work with most WiMAX signals, but there may be cases where the burst off duration is less than 1 ms and this value will need to be changed.

Key Path	Trigger, Periodic Timer
Remote Command	:TRIGger[:SEquence]:FRAMe:SYNC:HOLDoff <time> :TRIGger[:SEquence]:FRAMe:SYNC:HOLDoff?

	<code>:TRIGger[:SEquence]:FRAME:SYNC:HOLDoff:STATe OFF ON 0 1</code>
	<code>:TRIGger[:SEquence]:FRAME:SYNC:HOLDoff:STATe?</code>
Preset	On, 1.000 ms
State Saved	Saved in instrument state
Min	0 ms
Max	+500 ms
Default Unit	s
Initial S/W Revision	Prior to A.02.00

### Auto/Holdoff

Opens up a menu that lets you adjust Auto Trigger and Trigger Holdoff parameters

Key Path	Trigger
Readback line	Displays a summary of the Auto Trig and Holdoff settings, in square brackets First line: Auto Off or Auto On Second Line: "Hldf" followed by: <ul style="list-style-type: none"> <li>• If Holdoff is Off, readback Off</li> <li>• If Holdoff On and Type = Normal, readback value</li> <li>• If Holdoff On and Type = Above, readback value followed by AL</li> <li>• If Holdoff On and Type = Below, readback value followed by BL</li> <li>• If Holdoff Type selection is not supported by the current measurement, Holdoff Type is always Normal</li> </ul>
Initial S/W Revision	A.02.00

### Auto Trig

Sets the time that the analyzer will wait for the trigger conditions to be met. If they are not met after that much time, then the analyzer is triggered anyway.

Key Path	Trigger, Auto/Holdoff
Remote Command	<code>:TRIGger[:SEquence]:ATRigger &lt;time&gt;</code> <code>:TRIGger[:SEquence]:ATRigger?</code> <code>:TRIGger[:SEquence]:ATRigger:STATe OFF ON 0 1</code> <code>:TRIGger[:SEquence]:ATRigger:STATe?</code>
Example	TRIG:ATR:STAT ON TRIG:ATR 100 ms
Notes	The "time that the analyzer will wait" starts when the analyzer is ready for a trigger, which may be hundreds of ms after the data acquisition for a sweep is done. The "time" ends when the trigger condition is satisfied, not when the delay ends.

Preset	Off, 100 ms
State Saved	Saved in instrument state
Min	1 ms
Max	100 s
Default Unit	s
Initial S/W Revision	Prior to A.02.00

### Trig Holdoff

Sets the holdoff time between triggers. When the trigger condition is satisfied, the trigger occurs, the delay begins, and the holdoff time begins. New trigger conditions will be ignored until the holdoff time expires. For a free-running trigger, the holdoff value is the minimum time between triggers.

Key Path	Trigger, Auto/Holdoff
<b>Remote Command</b>	:TRIGger[:SEquence]:HOLDoff <time> :TRIGger[:SEquence]:HOLDoff? :TRIGger[:SEquence]:HOLDoff:STATe OFF ON 0 1 :TRIGger[:SEquence]:HOLDoff:STATe?
<b>Example</b>	TRIG:HOLD:STAT ON TRIG:HOLD 100 ms
Dependencies	Unavailable if the selected Input is BBIQ. If this is the case, the key is grayed out if it is pressed the informational message “Feature not supported for this Input” is displayed. If the SCPI command is sent, the error “Settings conflict; Feature not supported for this Input” is generated.
Preset	Off, 100 ms
State Saved	Saved in instrument state
Min	0 s
Max	0.5 s
Default Unit	s
Initial S/W Revision	Prior to A.02.00

### Gate Preset (Remote Command Only)

Presets the time-gated spectrum analysis capability.

This command sets gate parameter values to the ESA preset values, as follows:

Gate delay = 1 us

Gate length = 1 us

<b>Remote Command</b>	[:SENSe]:SWEep:TIME:GATE:PRESet ESA Compatibility
Initial S/W Revision	Prior to A.02.00

### Gate Level (Remote Command Only)

Sets the gate input transition point level for the external TRIGGER inputs on the front and rear panel. This is a legacy command for PSA compatibility. It is simply an alias to the equivalent trigger level command.

<b>Remote Command</b>	<code>[ :SENSe ] :SWEep:EGATe:EXTeRnal [1]  2:LEVel &lt;voltage&gt;</code> <code>[ :SENSe ] :SWEep:EGATe:EXTeRnal [1]  2:LEVel?</code>
<b>Notes</b>	This command is simply an alias to <code>:TRIGger[:SEQuence]:EXTeRnal[1] 2:LEVel</code> For details refer
<b>Initial S/W Revision</b>	Prior to A.02.00

### Gate Polarity (Remote Command Only)

Sets the polarity for the gate signal. This setup is now done using the gate trigger's slope setting.

When Positive (Pos) is selected, a positive-going edge (Edge) or a high voltage (Level) will satisfy the gate condition, after the delay set with the Gate Delay key. When Negative (Neg) is selected, a negative-going edge (Edge) or a low voltage (Level) will satisfy the gate condition after the delay.

<b>Remote Command</b>	<code>[ :SENSe ] :SWEep:EGATe:POLarity NEGative POSitive</code> <code>[ :SENSe ] :SWEep:EGATe:POLarity?</code>
<b>Example</b>	<code>SWE:EGAT:POL NEG</code> <code>SWE:EGAT:POL?</code>
<b>Preset</b>	POSitive
<b>State Saved</b>	Saved in instrument state
<b>Backwards Compatibility SCPI</b>	<code>[ :SENSe ] :SWEep:TIME:GATE:POLarity</code> ESA compatibility
<b>Initial S/W Revision</b>	Prior to A.02.00

<b>Remote Command</b>	<code>[ :SENSe ] :SWEep:TIME:GATE:LEVel HIGH LOW</code> <code>[ :SENSe ] :SWEep:TIME:GATE:LEVel?</code> ESA compatibility
<b>Preset</b>	HIGH
<b>Initial S/W Revision</b>	Prior to A.02.00

### Points

Sets the number of points per sweep. The resolution of setting the sweep time depends on the number of points selected. If Preset is selected, the number of points per sweep defaults to 1001. The current value



of points is displayed parenthetically, next to the sweep time in the lower-right corner of the display.

Changing the number of points has several effects on the analyzer. Since markers are read at the point location, the marker reading may change. All trace data is cleared.

<b>Key Path</b>	Sweep/Control
<b>Mode</b>	SA, WCDMA, C2K, WIMAX OFDMA, 1xEVDO, DVB-T/H, DTMB (CTTB), ISDB-T, CMMB, LTE, LTETDD, Digital Cable TV, WLAN, MSR, LTEAFDD, LTEATDD
<b>Remote Command</b>	[ :SENSe ] :CHPower:SWEep:POINts <integer> [ :SENSe ] :CHPower:SWEep:POINts?
<b>Example</b>	CHP:SWE:POIN 501 CHP:SWE:POIN?
<b>Notes</b>	Whenever the number of sweep points changes: All trace data is erased Any traces with Update Off also go to Display Off (like going from View to Blank in the older analyzers) Sweep time is re-quantized Any limit lines that are on are updated If averaging/hold is on, averaging/hold starts over
<b>Couplings</b>	Whenever the number of sweep points changes, the sweep time is re-quantized.
<b>Preset</b>	DVB-T/H: 2001 DTMB (CTTB): 2001 Other: 1001 ISDB-T: 2001 CMMB: 2001 1xEVDO: 512 Digital Cable TV: 2001
<b>State Saved</b>	Saved in instrument state.
<b>Min</b>	101
<b>Max</b>	20001
<b>Initial S/W Revision</b>	Prior to A.02.00
<b>Modified at S/W Revision</b>	A.02.00, A.03.00

## System

See ["System" on page 184](#)

## Trace/Detector

Accesses a menu of functions that enable you to control the detectors for the current measurement.

Key Path	Front-panel key
Initial S/W Revision	Prior to A.02.00

### Trace Type

Allows you to select the type of trace you want to use for the current measurement. The first page of this menu contains a 1-of-N selection of the trace type (Clear Write, Average, Max Hold, Min Hold) for the selected trace.

Key Path	Trace/Detector
Mode	SA, WCDMA, C2K, WIMAX OFDMA, 1xEVDO, DVB-T/H, DTMB (CTTB), ISDB-T, CMMB, LTE, LTETDD, Digital Cable TV, WLAN, MSR, LTEAFDD, LTEATDD
Remote Command	:TRACe:CHPower:TYPE WRITe AVERAge MAXHold MINHold :TRACe:CHPower:TYPE?
Example	TRAC:CHP:TYPE WRIT TRAC:CHP:TYPE?
Notes	WRITe = Clear Write AVERAge = Average MAXHold = Maximum Hold MINHold = Minimum Hold
Couplings	When Detector setting is "Auto" ([:SENSe]:CHPower:DETECTOR:AUTO?), Detector ([:SENSe]:CHPower:DETECTOR[:FUNction]?) switches aligning with the switch of this parameter: "NORMal" with WRITe (Clear Write), "AVERAge" with AVERAge, "POSitive (peak)" with MAXHold, and "NEGative (peak)" with MINHold.
Preset	AVERAge
State Saved	Saved in instrument state.
Range	ClearWrite Average MaxHold MinHold
Initial S/W Revision	Prior to A.02.00
Modified at S/W Revision	A.02.00, A.03.00

### Detector

Accesses a menu of functions that enable you to control the detectors for the current measurement. The following choices are available:

- Auto– the detector selected depends on marker functions, trace functions, average type, and the trace averaging function.

- Normal—the detector determines the peak of the CW-like signals, and it yields alternating maximums and minimums of noise-like signals. This is also referred to as Rosenfell detection.
- Average—the detector determines the average of the signal within the sweep points. The averaging method depends upon the Average Type selection (voltage, power or log scales).
- Peak—the detector determines the maximum of the signal within the sweep points.
- Sample—the detector indicates the instantaneous level of the signal at the center of the sweep points represented by each display point.
- Negative Peak—the detector determines the minimum of the signal within the sweep points.

Key Path	Detector
Initial S/W Revision	Prior to A.02.00

## Auto

Sets the detector for the currently selected trace to Auto.

Key Path	Trace/Detector
Mode	SA, WCDMA, C2K, WIMAX OFDMA, 1xEVDO, DVB-T/H, DTMB (CTTB), ISDB-T, CMMB, LTE, LTETDD, Digital Cable TV, WLAN, MSR, LTEAFDD, LTEATDD
<b>Remote Command</b>	[[:SENSE]:CHPower:DETECTOR:AUTO ON OFF 1 0 [:SENSE]:CHPower:DETECTOR:AUTO?
<b>Example</b>	CHP:DET:AUTO ON CHP:DET:AUTO?
Couplings	When Detector setting is “Auto” ([[:SENSE]:CHPower:DETECTOR:AUTO?]), Detector ([[:SENSE]:CHPower:DETECTOR:FUNCTION?]) switches aligning with the switch of this parameter: “NORMal” with Clear Write, “AVERage” with AVERage, “POSitive (peak)” with MAXHold, and “NEGative (peak)” with MINHold.
Preset	Others: ON DVB-T/H, DTMB (CTTB), ISDB-T, CMMB, Digital Cable TV: OFF
State Saved	Saved in instrument state.
Initial S/W Revision	Prior to A.02.00
Modified at S/W Revision	A.02.00, A.03.00

## Detector Selection

Selects a detector to be used by the analyzer for the current measurement.

Key Path	Trace/Detector
Mode	SA, WCDMA, C2K, WIMAX OFDMA, 1xEVDO, DVB-T/H, DTMB (CTTB), ISDB-T, CMMB, LTE, LTETDD, Digital Cable TV, WLAN, MSR, LTEAFDD, LTEATDD

<b>Remote Command</b>	[:SENSe]:CHPower:DETEctor[:FUNction] NORMal   AVERAge   POSitive   SAMPle   NEGative  [:SENSe]:CHPower:DETEctor[:FUNction]?
<b>Example</b>	CHP:DET NORM CHP:DET?
<b>Notes</b>	<p>When you manually select a detector (instead of selecting Auto), that detector is used regardless of other analyzer settings.</p> <p>The Normal detector determines the peak of CW-like signals, and it yields alternating maximums and minimums of noise-like signals. This method of detection is also referred to as Rosenfell detection.</p> <p>The Average detector determines the average of the signal within the sweep points. The averaging method is Power Average (RMS).</p> <p>The Peak detector determines the maximum of the signal within the sweep points.</p> <p>The Sample detector indicates the instantaneous level of the signal at the center of the sweep points represented by each display point.</p> <p>The Negative Peak detector determines the minimum of the signal within the sweep points.</p>
<b>Couplings</b>	When Detector setting is "Auto" ([:SENSe]:CHPower:DETEctor:AUTO?), Detector ([:SENSe]:CHPower:DETEctor[:FUNction]?) switches aligning with the switch of this parameter: "NORMal" with Clear Write, "AVERAge" with AVERAge, "POSitive (peak)" with MAXHold, and "NEGative (peak)" with MINHold.
<b>Preset</b>	AVERAge
<b>State Saved</b>	Saved in instrument state.
<b>Range</b>	Normal Average Peak Sample Negative Peak
<b>Initial S/W Revision</b>	Prior to A.02.00
<b>Modified at S/W Revision</b>	A.02.00, A.03.00

## Trigger

See ["Trigger" on page 244](#)

### Free Run

See ["Free Run " on page 251](#)

### Video

See ["Video \(IF Envelope\) " on page 1160](#)

### Trigger Level

See ["Trigger Level " on page 1161](#)

### Trig Slope

See ["Trig Slope " on page 1162](#)

### Trig Delay

See ["Trig Delay " on page 254](#)

### External 1

See ["External 1 " on page 1175](#)

### Trigger Level

See ["Trigger Level " on page 1175](#)

### Trig Slope

See ["Trig Slope " on page 1176](#)

### Trig Delay

See ["Trig Delay " on page 257](#)

### Zero Span Delay Comp

See ["Zero Span Delay Comp On/Off " on page 1164](#)

### External 2

See ["External 2 " on page 1177](#)

### Trigger Level

See ["Trigger Level " on page 1177](#)

### Trig Slope

See ["Trig Slope " on page 1178](#)

### **Trig Delay**

See ["Trig Delay "](#) on page 260

### **Zero Span Delay Comp**

See ["Zero Span Delay Comp On/Off"](#) on page 1166

### **RF Burst**

See ["RF Burst "](#) on page 1178

### **Absolute Trigger**

See ["Absolute Trigger Level"](#) on page 1179

### **Relative Trigger**

See ["Relative Trigger Level"](#) on page 1168

### **Trig Slope**

See ["Trigger Slope "](#) on page 1180

### **Trig Delay**

See ["Trig Delay "](#) on page 264

### **Periodic Timer**

See ["Periodic Timer \(Frame Trigger\) "](#) on page 1170

### **Period**

See ["Period "](#) on page 1171

### **Offset**

See ["Offset "](#) on page 1172

### **Reset Offset Display**

See ["Reset Offset Display "](#) on page 1174

### **Sync Source**

See ["Sync Source "](#) on page 1174

### **Off**

See ["Off "](#) on page 1175

### **External 1**

See ["External 1 "](#) on page 1175

## 8 Channel Power Measurement Trigger

### Trigger Level

See ["Trigger Level "](#) on page 1175

### Trig Slope

See ["Trig Slope "](#) on page 1176

### External 2

See ["External 2 "](#) on page 1177

### Trigger Level

See ["Trigger Level "](#) on page 1177

### Trig Slope

See ["Trig Slope "](#) on page 1178

### RF Burst

See ["RF Burst "](#) on page 1178

### Absolute Trigger

See ["Absolute Trigger Level"](#) on page 1179

### Trig Slope

See ["Trigger Slope "](#) on page 1180

### Trig Delay

See ["Trig Delay"](#) on page 275

### Auto/Holdoff

See ["Auto/Holdoff "](#) on page 1181

### Auto Trig

See ["Auto Trig "](#) on page 1181

### Trig Holdoff

See ["Trig Holdoff "](#) on page 1182

### Internal

See ["Internal"](#) on page 277



## User Preset

Accesses a menu that gives you the following three choices:

- User Preset – recalls a state previously saved using the Save User Preset function.
- User Preset All Modes – presets all of the modes in the analyzer
- Save User Preset– saves the current state for the current mode

### NOTE

In products that run multiple instances of the X-Series Application, all instances use the same location to save User Preset state. So Save User Preset of one instance will overwrite the Save User Preset of another instance.

Key Path	Front-panel key
Backwards Compatibility Notes	<p>User Preset is actually loading a state, and in legacy analyzers, it was possible to load a state without affecting the trace data, limit lines or correction data. Similarly it was possible to do a User Preset without affecting the trace data, limit lines or correction data.</p> <p>In the X-Series, “state” always includes all of this data; so whenever state is loaded, or User Preset is executed, all of the traces, limit lines and corrections are affected. Although this differs from previous behavior, it is desirable behavior, and should not cause adverse issues for users.</p> <p>On ESA and PSA, User Preset affected the entire instrument’s state. In the X-Series, User Preset only recalls the state for the active mode. There is a User Preset file for each mode. User Preset can never cause a mode switch as it can in legacy analyzers. If you want to recall all modes to their user preset file state, you will need to do a User Preset after mode switching into each mode.</p> <p>User Preset recalls mode state which can now include data like traces; whereas on ESA and PSA, User Preset did not affect data.</p>
Initial S/W Revision	Prior to A.02.00

## User Preset

User Preset sets the state of the currently active mode back to the state that was previously saved for this mode using the Save User Preset menu key or the SCPI command, SYST:PRES:USER:SAV. It not only recalls the Mode Preset settings, but it also recalls all of the mode persistent settings, and the Input/Output system setting that existed at the time Save User Preset was executed.

If a Save User Preset has not been done at any time, User Preset recalls the default user preset file for the currently active mode. The default user preset files are created if, at power-on, a mode detects there is no user preset file. There will never be a scenario when there is no user preset file to restore. For each mode, the default user preset state is the same state that would be saved if a Save User Preset is performed in each mode right after doing a Restore Mode Default and after a Restore Input/Output Defaults.

The User Preset function does the following:

- Aborts the currently running measurement.
- Sets the mode State to the values defined by Save User Preset.
- Makes the saved measurement for the currently running mode the active measurement.
- Brings up the saved menu for the power-on mode.

- Clears the input and output buffers.
- Sets the Status Byte to 0.

Key Path	User Preset
<b>Remote Command</b>	:SYSTem:PRESet:USER
<b>Example</b>	:SYST:PRES:USER:SAVE:SYST:PRES:USER
Notes	:SYST:PRES:USER:SAVE is used to save the current state as the user preset state. Clears all pending OPC bits. The Status Byte is set to 0. Pressing the User Preset front-panel key while already in the User Preset menu will cause the User Preset to get executed
Couplings	A user preset will cause the currently running measurement to be aborted and cause the saved measurement to be active. Recalling a User Preset file has the same issues that recalling a Save State file has. Some settings may need to be limited and therefore re-coupled, since the capabilities of the mode may have changes when the User Preset file was last saved.
Initial S/W Revision	Prior to A.02.00

## User Preset All Modes

Recalls all of the User Preset files for each mode, switches to the power-on mode, and activates the saved measurement from the power-on mode User Preset file.

**NOTE**

When the instrument is secured, all of the user preset files are converted back to their default user preset files.

The User Preset function does the following:

- Aborts the currently running measurement.
- Switches the Mode to the power-on mode.
- Restores the User Preset files for each mode.
- Makes the saved measurement for the power-on mode the active measurement.
- Brings up the saved menu for the power-on mode.
- Clears the input and output buffers.
- Sets the Status Byte to 0.

Key Path	User Preset
<b>Remote Command</b>	:SYSTem:PRESet:USER:ALL
<b>Example</b>	:SYST:PRES:USER:SAVE:SYST:PRES:USER:ALL
Notes	Clears all pending OPC bits. The Status Byte is set to 0. :SYST:PRES:USER:SAVE is used to save the current state as the user preset state.
Couplings	A user preset will cause the currently running measurement to be aborted, cause a mode switch to the power-on mode, and cause the saved measurement to be active in the power-on mode.

---

Recalling a User Preset file has the same issues that recalling a Save State file has. Some settings may need to be limited and therefore re-coupled, since the capabilities of the mode may have changes when the User Preset file was last saved.

---

Initial S/W Revision      Prior to A.02.00

---

## Save User Preset

Saves the currently active mode and its State. You can recall this User Preset file by pressing the User Preset menu key or sending the SYST:PRES:USER remote command. This same state is also saved by the Save State function.

Key Path	User Preset
<b>Remote Command</b>	:SYSTem:PRESet:USER:SAVE
<b>Example</b>	:SYST:PRES:USER:SAVE
Notes	:SYST:PRES:SAVE creates the same file as if the user requested a *SAV or a MMEM:STOR:STAT, except User Preset Save does not allow the user to specify the filename or the location of the file.
Initial S/W Revision	Prior to A.02.00

## View/Display

Accesses a menu of functions that enable you to control the instrument display as well as turn the bar graph On and Off.

The results of the measurement can be displayed as a single spectrum trace view or displayed with a Bar Graph trace on the spectrum trace.

### Spectrum View with Bar Graph off

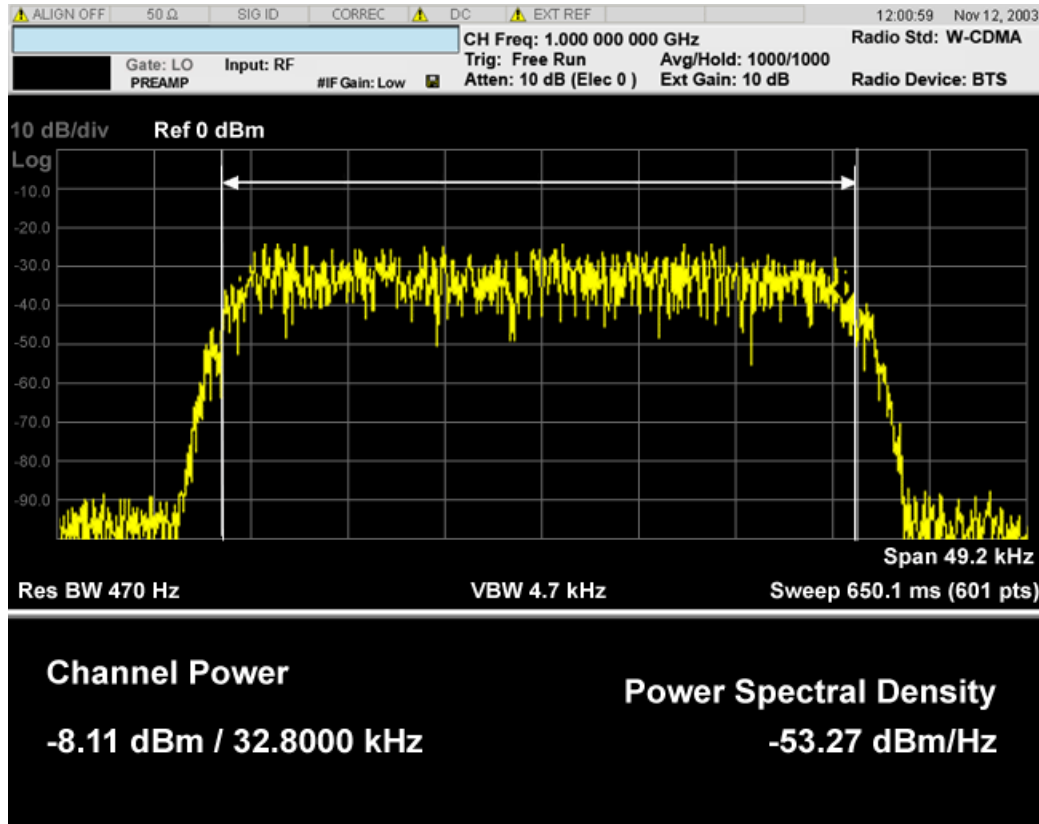

### Spectrum View with Bar Graph on

This View is the same as the 'Spectrum' view, but has a blue bar between the markers that indicates the measured output power level. The bar graph is activated when the "Bar Graph" Soft Key is set to ON under the View/Display menu. The actual measured output power level is displayed on the display at the bottom of the bar.

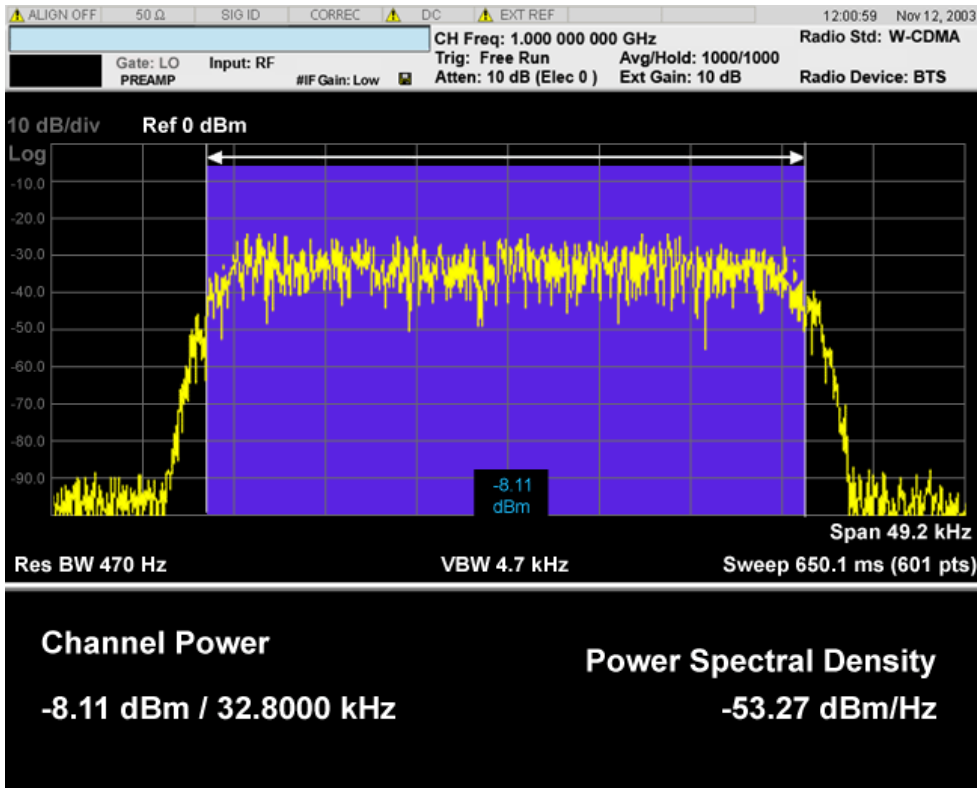

If the current mode is WLAN and the format is WLAN 802.11 ac 80+80 MHz, the spectrum view is changed a little so that the results of both carrier segments can be displayed.

Spectrum View with Bar Graph off for WLAN 802.11 ac (80 + 80 MHz):

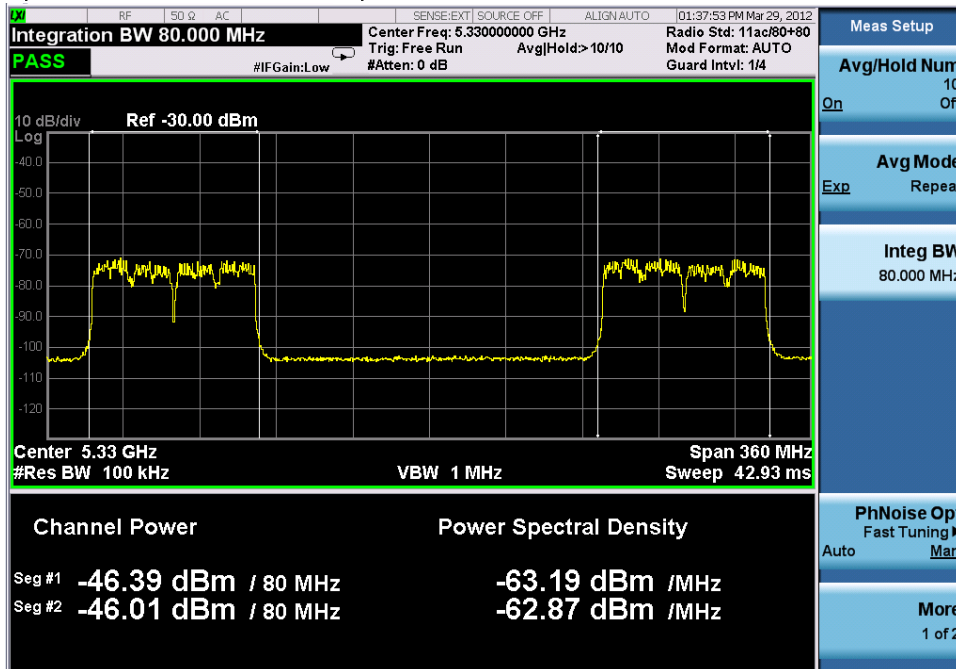

Spectrum View with Bar Graph on for WLAN 802.11 ac (80 + 80 MHz):

## 8 Channel Power Measurement View/Display

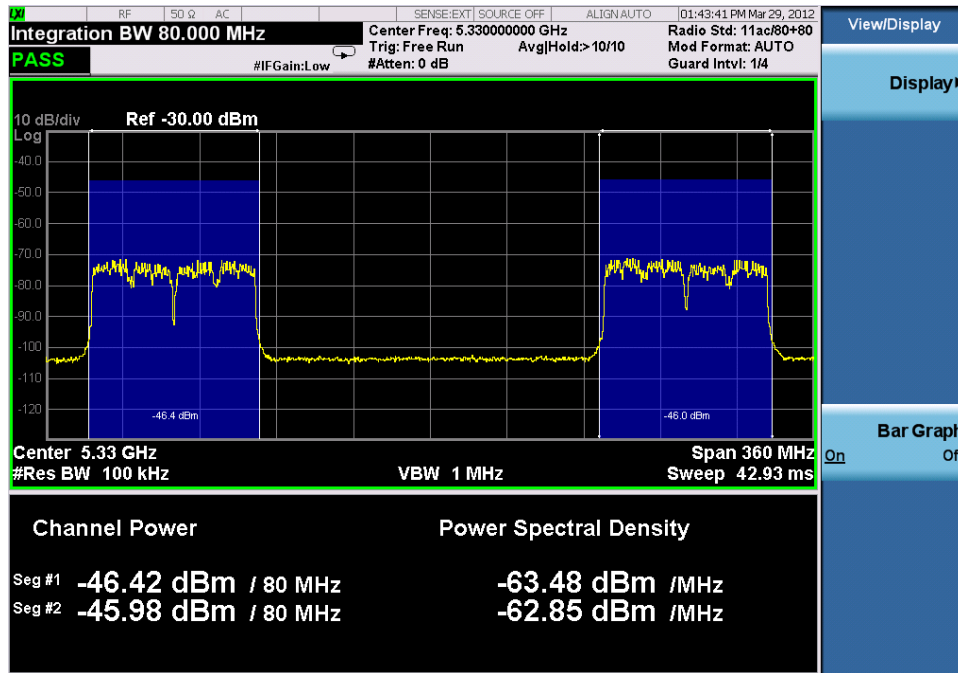

### Power Results:

The spectrum trace and power bars are displayed in the upper window. Total carrier power, total PSD and total format carrier power are displayed in the lower window. Total format carrier power is total power of carriers of the same Radio Format. If there is no carrier of the corresponding format, it is not displayed. Thus items in the total format power table changes depending on the carrier configuration.

### Carrier Info:

The lower window of Power Results view is replaced by the carrier info table in this view. Carrier center frequency can be displayed in either offset or absolute frequency depending on Carrier Freq. The table can be scrolled by Carrier Result on Meas Setup menu or by Select Carrier on Config Carriers menu. The highlighted row changes as either Carrier Result or Select Carrier is changed. The highlighted row and these keys are not coupled.

Key Path	Front-panel key
Initial S/W Revision	Prior to A.02.00

### Display

The Display menu is common to most measurements, and is used for configuring items on the display. Some Display menu settings apply to all the measurements in a mode, and some only to the current measurement. Those under the System Display Settings key apply to all measurements in all modes.

Key Path	Display
Key Path	View/Display
Initial S/W Revision	Prior to A.02.00

## Annotation

Turns on and off various parts of the display annotation. The annotation is divided up into four categories:

1. Meas Bar: This is the measurement bar at the top of the screen. It does not include the settings panel or the Active Function. Turning off the Meas Bar turns off the settings panel and the Active Function. When the Meas Bar is off, the graticule area expands to fill the area formerly occupied by the Meas Bar.
2. Screen Annotation: this is the annotation and annunciation around the graticule, including any annotation on lines (such as the display line, the threshold line, etc.) This does NOT include the marker number or the N dB result. When off, the graticule expands to fill the entire graticule area.
3. Trace annotation: these are the labels on the traces, showing their detector (or their math mode).
4. Active Function annotation: this is the active function display in the meas bar, and all of the active function values displayed on softkeys.

See the figure below. Each type of annotation can be turned on and off individually.

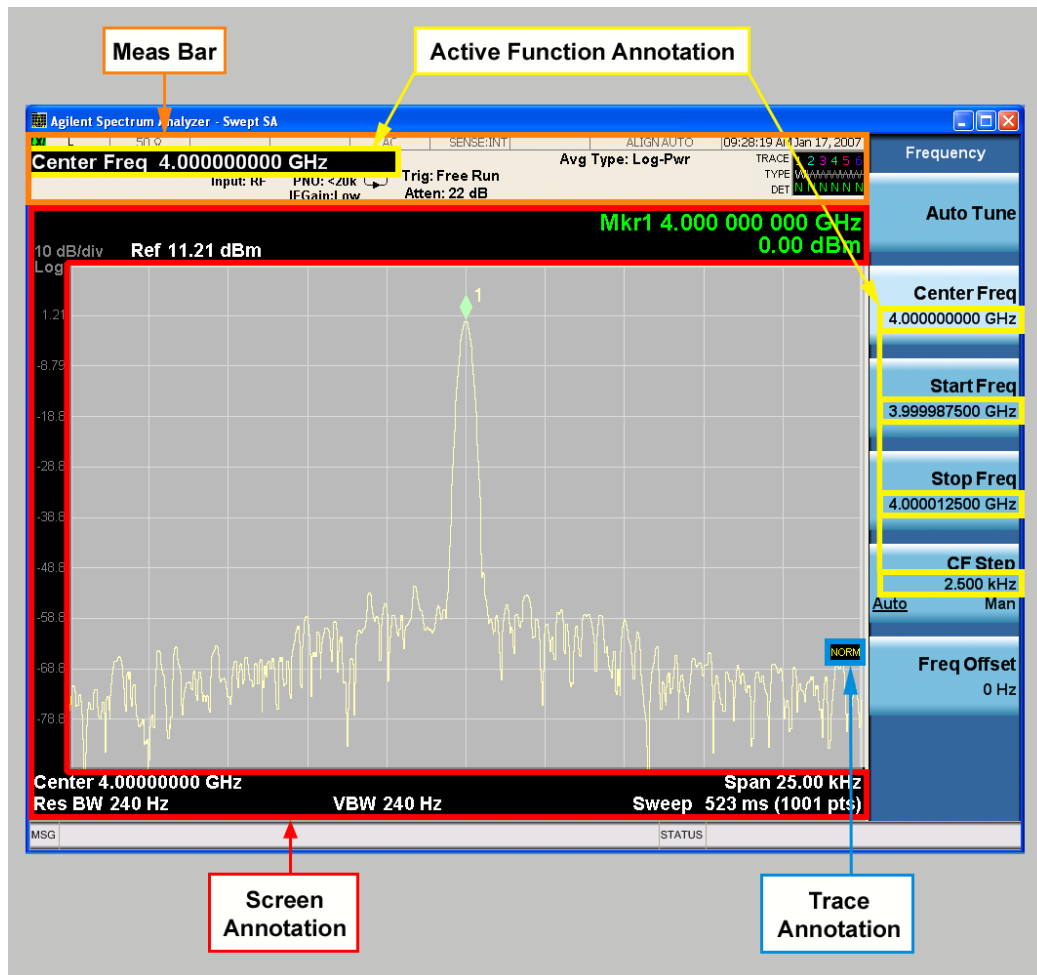

Key Path	View/Display, Display
Initial S/W Revision	Prior to A.02.00

### Meas Bar On/Off

This function turns the Measurement Bar on and off, including the settings panel. When off, the graticule area expands to fill the area formerly occupied by the Measurement Bar.

Key Path	View/Display, Display, Annotation
<b>Remote Command</b>	:DISPlay:ANNotation:MBAR[:STATe] OFF ON 0 1 :DISPlay:ANNotation:MBAR[:STATe]?
<b>Example</b>	DISP:ANN:MBAR OFF
Dependencies	Grayed out and forced to OFF when System Display Settings, Annotation is set to Off.
Preset	On This should remain Off through a Preset when System DisplaySettings, Annotation is set to Off.
State Saved	Saved in instrument state.
Initial S/W Revision	Prior to A.02.00

### Screen

This controls the display of the annunciation and annotation around the graticule, including any annotation on lines (such as the display line, the threshold line, etc.) and the y-axis annotation. This does NOT include marker annotation (or the N dB result). When off, the graticule expands to fill the entire graticule area, leaving only the 1.5% gap above the graticule as described in the Trace/Detector chapter.

Key Path	View/Display, Display, Annotation
<b>Remote Command</b>	:DISPlay:ANNotation:SCReen[:STATe] OFF ON 0 1 :DISPlay:ANNotation:SCReen[:STATe]?
<b>Example</b>	DISP:ANN:SCR OFF
Dependencies	Grayed-out and forced to OFF when System Display Settings, Annotation is set to Off.
Preset	On This should remain Off through a Preset when System DisplaySettings, Annotation is set to Off
State Saved	Saved in instrument state.
Initial S/W Revision	Prior to A.02.00

### Active Function Values On/Off

Turns on and off the active function display in the Meas Bar, and all of the active function values displayed on the softkeys.



Note that all of the softkeys that have active functions have these numeric values blanked when this function is on. This is a security feature..

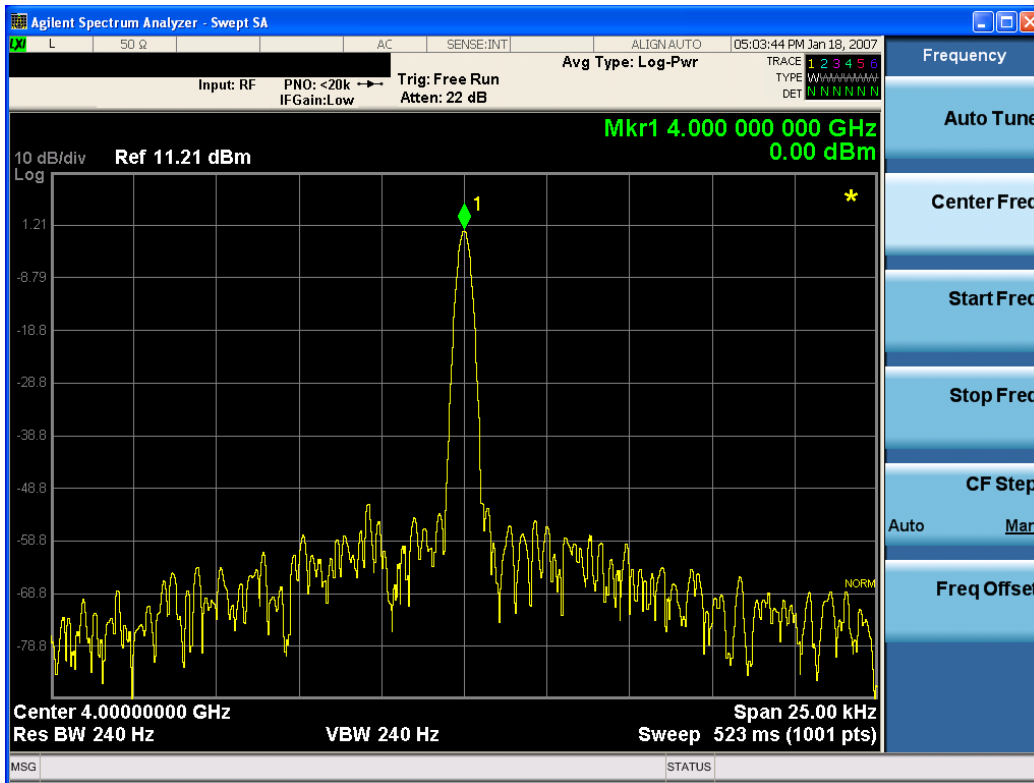

Key Path	View/Display, Display, Annotation
Remote Command	:DISPlay:ACTivefunc[:STATE] ON OFF 1 0 :DISPlay:ACTivefunc[:STATE]?
Example	DISP:ACT OFF
Dependencies	Grayed out and forced to OFF when System Display Settings, Annotation is set to Off.
Preset	On This should remain Off through a Preset when System DisplaySettings, Annotation is set to Off
State Saved	Saved in instrument state.
Initial S/W Revision	Prior to A.02.00

## Title

Displays menu keys that enable you to change or clear a title on your display.

Key Path	View/Display, Display
Initial S/W Revision	Prior to A.02.00

## Change Title

Writes a title into the "measurement name" field in the banner, for example, "Swept SA".

Press Change Title to enter a new title through the alpha editor. Press Enter or Return to complete the entry. Press ESC to cancel the entry and preserve your existing title.

The display title will replace the measurement name. It remains for this measurement until you press Change Title again, or you recall a state, or a Preset is performed. A title can also be cleared by pressing Title, Clear Title.

### NOTE

Notice the inclusion of the <measurement> parameter in the command below. Because each measurement remembers the Display Title, the command must be qualified with the measurement name. For the Swept SA measurement this is not the case; no <measurement> parameter is used when changing the Display Title for the Swept SA measurement.

Key Path	View/Display, Display, Title
Mode	All
Remote Command	:DISPlay:<measurement>:ANNotation:TITLe:DATA <string> :DISPlay:<measurement>:ANNotation:TITLe:DATA?
Example	DISP:ANN:TITL:DATA "This Is My Title" This example is for the Swept SA measurement in the Spectrum Analyzer mode. The SANalyzer <measurement> name is not used. DISP:ACP:ANN:TITL:DATA "This Is My Title" This example is for Measurements other than Swept SA. Both set the title to: This Is My Title
Notes	Pressing this key cancels any active function. When a title is edited the previous title remains intact (it is not cleared) and the cursor goes at the end so that characters can be added or BKSP can be used to go back over previous characters.
Preset	No title (measurement name instead)
State Saved	Saved in instrument state.
Initial S/W Revision	Prior to A.02.00

## Clear Title

Clears a title from the front-panel display. Once cleared, the title cannot be retrieved. After the title is cleared, the current Measurement Name replaces it in the title bar.

Key Path	View/Display, Display, Title
Example	The following commands clear the title and restore the measurement's original title: DISP:ANN:TITL:DATA "" This example is for the Swept SA measurement in the Spectrum Analyzer mode. The SANalyzer <measurement> name is not used. DISP:ACP:ANN:TITL:DATA "" This example is for ACP; in measurements other than Swept SA the measurement name is required.

Notes	Uses the :DISPlay:<measurement>:ANNOtation:TITLe:DATA <string> command with an empty string (in the Swept SA, the <measurement> is omitted).
Preset	Performed on Preset.
Initial S/W Revision	Prior to A.02.00

## Graticule

Pressing Graticule turns the display graticule On or Off. It also turns the graticule y-axis annotation on and off.

Key Path	View/Display, Display
<b>Remote Command</b>	:DISPlay:WINDow[1]:TRACe:GRATicule:GRID[:STATe] OFF ON 0 1 :DISPlay:WINDow[1]:TRACe:GRATicule:GRID[:STATe]?
<b>Example</b>	DISP:WIND:TRAC:GRAT:GRID OFF
Notes	The graticule is the set of horizontal and vertical lines that make up the grid/divisions for the x-axis and y-axis.
Preset	On
State Saved	Saved in instrument state
Initial S/W Revision	Prior to A.02.00

## System Display Settings

These settings are "Mode Global" – they affect all modes and measurements and are reset only by Restore Misc Defaults or Restore System Defaults under System.

Key Path	View/Display, Display
Initial S/W Revision	Prior to A.02.00

## Annotation Local Settings

This is a Mode Global override of the meas local annotation settings. When it is All Off, it forces ScreenAnnotation, Meas Bar, Trace, and Active Function Values settings to be OFF for all measurements in all modes. This provides the security based "annotation off" function of previous analyzers; hence it uses the legacy SCPI command.

When it is All Off, the Screen, Meas Bar, Trace, and Active Function Values keys under the Display, Annotation menu are grayed out and forced to Off. When Local Settings is selected, you are able to set the local annotation settings on a measurement by measurement basis.

Key Path	View/Display, Display, System Display Settings
<b>Remote Command</b>	:DISPlay:WINDow[1]:ANNOtation[:ALL] OFF ON 0 1

	:DISPlay:WINDow[1]:ANNotation[:ALL]?
<b>Example</b>	:DISP:WIND:ANN OFF
Preset	On (Set by Restore Misc Defaults)
State Saved	Not saved in instrument state.
Backwards Compatibility Notes	The WINDow parameter and optional subopcode is included for backwards compatibility but ignored - all windows are equally affected.
Initial S/W Revision	Prior to A.02.00

## Themes

Accesses a menu of functions that enable you to choose the theme to be used when saving the screen image.

The **Themes** option is the same as the **Themes** option under the **Display** and **Page Setup** dialogs. It allows you to choose between themes to be used when saving the screen image.

Key Path	Save, Screen Image
<b>Remote Command</b>	:MMEMory:STORe:SCReEn:THEMe TDColor   TDMonochrome   FCOLor   FMONochrome  :MMEMory:STORe:SCReEn:THEMe?
<b>Example</b>	:MMEM:STOR:SCR:THEM TDM
Preset	3D Color; Is not part of Preset, but is reset by Restore Misc Defaults or Restore System Defaults All and survives subsequent running of the modes.
Readback	3D Color   3D Mono   Flat Color   Flat Mono
Backwards Compatibility Notes	In ESA and PSA we offer the choice of "Reverse Bitmap" or "Reverse Metafile" when saving screen images. This is much like the "Flat Color" theme available in X-Series. Also, if you selected Reverse Bitmap AND a black & white screen image, that would be much like "Flat Monochrome". In other words, each of the X-Series themes has a similar screen image type in ESA/PSA. But they are not identical.
Initial S/W Revision	Prior to A.02.00

## 3D Color

Selects a standard color theme with each object filled, shaded and colored as designed.

Key Path	Save, Screen Image, Themes
<b>Example</b>	MMEM:STOR:SCR:THEM TDC
Readback	3D Color
Initial S/W Revision	Prior to A.02.00

### 3D Monochrome

Selects a format that is like 3D color but shades of gray are used instead of colors.

Key Path	Save, Screen Image, Themes
<b>Example</b>	MMEM:STOR:SCR:THEM TDM
Readback	3D Mono
Initial S/W Revision	Prior to A.02.00

### Flat Color

Selects a format that is best when the screen is to be printed on an ink printer.

Key Path	Save, Screen Image, Themes
<b>Example</b>	MMEM:STOR:SCR:THEM FCOL
Readback	Flat Color
Initial S/W Revision	Prior to A.02.00

### Flat Monochrome

Selects a format that is like Flat Color. But only black is used (no colors, not even gray), and no fill.

Key Path	Save, Screen Image, Themes
<b>Example</b>	MMEM:STOR:SCR:THEM FMON
Readback	Flat Mono
Initial S/W Revision	Prior to A.02.00

### Bar Graph

Turns the Bar Graph On and Off.

Key Path	DVB-T/H, DTMB (CTTB), ISDB-T, CMMB: View/Display, RF SpectrumOthers: View/Display
Mode	SA, WCDMA, C2K, WIMAX OFDMA, 1xEVDO, DVB-T/H, DTMB (CTTB), ISDB-T, CMMB, LTE, LTE-TDD, Digital Cable TV, WLAN, MSR, LTEAFDD, LTEATDD
<b>Remote Command</b>	:DISPlay:CHPower:VIEW[1]:WINDow[1]:BGRaph ON OFF 1 0 :DISPlay:CHPower:VIEW[1]:WINDow[1]:BGRaph?
<b>Example</b>	DISP:CHP:VIEW:WIND:BGR ON DISP:CHP:VIEW:WIND:BGR?
Notes	You must be in the Spectrum Analysis mode, W-CDMA mode, cdma2000 mode, DVB-T/H mode, DTMB (CTTB) mode, ISDB-T mode, CMMB mode, Digital Cable TV mode, LTE mode, LTE TDD mode, WLAN mode, 1xEVDO mode, MSR, LTE-Advanced FDD/TDD mode or WIMAX OFDMA mode to use this command. Use :INSTRument:SElect to set the mode.

8 Channel Power Measurement  
View/Display

Preset	OFF
State Saved	Saved in instrument state.
Range	On Off
Initial S/W Revision	Prior to A.02.00
Modified at S/W Revision	A.02.00, A.03.00

## 9 ACP Measurement

ACP is a measurement of the amount of interference, or power, in an adjacent frequency channel. The results are displayed as a bar graph or as spectrum data, with measurement data at specified offsets. For measurement results and views, see ["View/Display" on page 868](#).

This topic contains the following sections:

["Measurement Commands for ACP" on page 556](#)

["Remote Command Results for ACP Measurement" on page 557](#)

## Measurement Commands for ACP

The following commands are used to retrieve the measurement results:

```
:CONFigure:ACP  
:CONFigure:ACP:NDEFault  
:INITiate:ACP  
:FETCh:ACP [n] ?  
:READ:ACP [n] ?  
:MEASure:ACP [n] ?
```

For more measurement related commands, see the SENSE subsystem, and the section Remote Measurement Functions@29978.



## Remote Command Results for ACP Measurement

Condition	N	Results Returned
Mode = SA mode, Radio Std = None, Number of carriers = 1 and only offset A is on	Not specified or n = 1	Returns 3 comma-separated values that correspond to: Reference carrier power, lower-adjacent channel power (dBc), and upper-adjacent channel power (dBc).
Mode = DTMB (CTTB) or CMMB, Radio BW = 8 MHz, Number of carriers = 1 and Meas Type = Power spectral density reference	not specified or n = 1	Returns 32 comma-separated scalar results, in the following order. 1. 0.0 2. Total carrier power (dBm/Hz or dBm/MHz) 3. 0.0 4. Reference carrier power (dBm/Hz or dBm/MHz) 5. Lower offset A - relative power (dB) 6. Lower offset A - absolute power (dBm/Hz or dBm/MHz) 7. Upper offset A - relative power (dB) 8. Upper offset A - absolute power (dBm/Hz or dBm/MHz) 9. Lower offset B - relative power (dB) 10. Lower offset B - absolute power (dBm/Hz or dBm/MHz) 11. Upper offset B - relative power (dB) 12. Upper offset B - absolute power (dBm/Hz or dBm/MHz) ... 25. Lower offset F - relative power (dB) 26. Lower offset F - absolute power (dBm/Hz or dBm/MHz) 27. Upper offset F - relative power (dB) 28. Upper offset F - absolute power (dBm/Hz or dBm/MHz) 29. -999.0 30. -999.0 31. -999.0 32. -999.0 The last four (29, 30, 31 and 32) results always returned -999.0. If the results are not available, -999.0 is returned.
Meas Type = Total power reference	Not specified or n = 1	Returns 28 comma-separated scalar results, in the following order. 1. 0.0 2. Total carrier power (dBm) 3. 0.0 4. Reference carrier power (dBm) 5. Lower offset A - relative power (dB) 6. Lower offset A - absolute power (dBm) 7. Upper offset A - relative power (dB) 8. Upper offset A - absolute power (dBm)

Condition	N	Results Returned
		9. Lower offset B - relative power (dB) 10. Lower offset B - absolute power (dBm) 11. Upper offset B - relative power (dB) 12. Upper offset B - absolute power (dBm) ... 25. Lower offset F - relative power (dB) 26. Lower offset F - absolute power (dBm) 27. Upper offset F - relative power (dB) 28. Upper offset F - absolute power (dBm) If the results are not available, -999.0 is returned. When in MSR and LTE-Advanced FDD/TDD, this trace includes only outer offset results and their reference value(s).
Meas Type = Power spectral density reference	not specified or n = 1	Returns 28 comma-separated scalar results, in the following order. 1. 0.0 2. Total carrier power (dBm/Hz or dBm/MHz) 3. 0.0 4. Reference carrier power (dBm/Hz or dBm/MHz) 5. Lower offset A - relative power (dB) 6. Lower offset A - absolute power (dBm/Hz or dBm/MHz) 7. Upper offset A - relative power (dB) 8. Upper offset A - absolute power (dBm/Hz or dBm/MHz) 9. Lower offset B - relative power (dB) 10. Lower offset B - absolute power (dBm/Hz or dBm/MHz) 11. Upper offset B - relative power (dB) 12. Upper offset B - absolute power (dBm/Hz or dBm/MHz) ... 25. Lower offset F - relative power (dB) 26. Lower offset F - absolute power (dBm/Hz or dBm/MHz) 27. Upper offset F - relative power (dB) 28. Upper offset F - absolute power (dBm/Hz or dBm/MHz) If the results are not available, -999.0 is returned. When in MSR and LTE-Advanced FDD/TDD, this trace includes only outer offset results and their reference value(s).
Meas Method = FAST	not specified or n = 1	Returns 5 comma-separated results, in the following order: 1. Reference carrier - absolute power (dBm) 2. Lower offset A - absolute power (dBm) 3. Upper offset A - absolute power (dBm) 4. Lower offset B - absolute power (dBm) 5. Upper offset B - absolute power (dBm)
Mode = MSR , LTEAFDD,	Not specified	Returns 28 comma-separated scalar results, in the following order.

Condition	N	Results Returned
LTEATDD, Meas Type = Total power reference and Power Ref = Left & Right Carriers	or n = 1	<ol style="list-style-type: none"> <li>1. 0.0</li> <li>2. Total carrier power (dBm)</li> <li>3. Left Reference carrier power (dBm)</li> <li>4. Right Reference carrier power (dBm)</li> <li>5. Lower offset A - relative power (dB)</li> <li>6. Lower offset A - absolute power (dBm)</li> <li>7. Upper offset A - relative power (dB)</li> <li>8. Upper offset A - absolute power (dBm)</li> <li>9. Lower offset B - relative power (dB)</li> <li>10. Lower offset B - absolute power (dBm)</li> <li>11. Upper offset B - relative power (dB)</li> <li>12. Upper offset B - absolute power (dBm)</li> <li>...</li> <li>25. Lower offset F - relative power (dB)</li> <li>26. Lower offset F - absolute power (dBm)</li> <li>27. Upper offset F - relative power (dB)</li> <li>28. Upper offset F - absolute power (dBm)</li> </ol> <p>If the results are not available, -999.0 is returned.</p>
Mode = MSR , LTEAFDD, LTEATDD, Meas Type = Power spectral density reference and Power Ref = Left & Right Carriers	not specified or n = 1	<p>Returns 28 comma-separated scalar results, in the following order.</p> <ol style="list-style-type: none"> <li>1. 0.0</li> <li>2. Total carrier power (dBm/Hz or dBm/MHz)</li> <li>3. Left reference carrier power (dBm/Hz or dBm/MHz)</li> <li>4. Right reference carrier power (dBm/Hz or dBm/MHz)</li> <li>5. Lower offset A - relative power (dB)</li> <li>6. Lower offset A - absolute power (dBm/Hz or dBm/MHz)</li> <li>7. Upper offset A - relative power (dB)</li> <li>8. Upper offset A - absolute power (dBm/Hz or dBm/MHz)</li> <li>9. Lower offset B - relative power (dB)</li> <li>10. Lower offset B - absolute power (dBm/Hz or dBm/MHz)</li> <li>11. Upper offset B - relative power (dB)</li> <li>12. Upper offset B - absolute power (dBm/Hz or dBm/MHz)</li> <li>...</li> <li>25. Lower offset F - relative power (dB)</li> <li>26. Lower offset F - absolute power (dBm/Hz or dBm/MHz)</li> <li>27. Upper offset F - relative power (dB)</li> <li>28. Upper offset F - absolute power (dBm/Hz or dBm/MHz)</li> </ol> <p>If the results are not available, -999.0 is returned.</p> <p>When in MSR and LTE-Advanced FDD/TDD, this trace includes only outer offset results and their reference value(s).</p>
Meas Type = Total	n = 2	Returns 48 scalar results, in the following order:

Condition	N	Results Returned
power reference		1. Channel (1) - relative power (dB) 2. Channel (1) - absolute power (dBm) 3. Channel (2) - relative power (dB) 4. Channel (2) - absolute power (dBm) ... 23. Channel (12) - relative power (dB) 24. Channel (12) - absolute power (dBm) 25. Lower offset A - relative power (dB) 26. Lower offset A - absolute power (dBm) 27. Upper offset A - relative power (dB) 28. Upper offset A - absolute power (dBm) 29. Lower offset B - relative power (dB) 30. Lower offset B - absolute power (dBm) 31. Upper offset B - relative power (dB) 32. Upper offset B - absolute power (dBm) ... 45. Lower offset F - relative power (dB) 46. Lower offset F - absolute power (dBm) 47. Upper offset F - relative power (dB) 48. Upper offset F - absolute power (dBm) If the results are not available, -999.0 is returned. When in MSR and LTE-Advanced FDD/TDD, this trace includes only outer offset results and their reference value(s).
Meas Type = Power spectral density reference	n = 2	Returns 48 scalar results, in the following order: 1. Channel (1) - relative power (dB) 2. Channel (1) - absolute power (dBm/Hz or dBm/MHz) 3. Channel (2) - relative power (dB) 4. Channel (2) - absolute power (dBm/Hz or dBm/MHz) ... 23. Channel (12) - relative power (dB) 24. Channel (12) - absolute power (dBm/Hz or dBm/MHz) 25. Lower offset A - relative power (dB) 26. Lower offset A - absolute power (dBm/Hz or dBm/MHz) 27. Upper offset A - relative power (dB) 28. Upper offset A - absolute power (dBm/Hz or dBm/MHz) 29. Lower offset B - relative power (dB) 30. Lower offset B - absolute power (dBm/Hz or dBm/MHz) 31. Upper offset B - relative power (dB) 32. Upper offset B - absolute power (dBm/Hz or dBm/MHz)

Condition	N	Results Returned
		<p>...</p> <p>45. Lower offset F - relative power (dB)</p> <p>46. Lower offset F - absolute power (dBm/Hz or dBm/MHz)</p> <p>47. Upper offset F - relative power (dB)</p> <p>48. Upper offset F - absolute power (dBm/Hz or dBm/MHz)</p> <p>If the results are not available, -999.0 is returned.</p> <p>When in MSR and LTE-Advanced FDD/TDD, this trace includes only outer offset results.</p>
Mode = DTMB (CTTB) or CMMB, Radio BW = 8 MHz and Meas Type = Total power reference	n = 3	<p>Returns 28 scalar values of the pass/fail (0 = passed, or 1 = failed) determined by testing the relative to the reference carrier and by testing the absolute power limit of the offset frequencies (measured as total power in dB):</p> <ol style="list-style-type: none"> <li>1. Lower offset A - relative limit result</li> <li>2. Lower offset A - absolute limit result</li> <li>3. Upper offset A - relative limit result</li> <li>4. Upper offset A - absolute limit result</li> <li>5. Lower offset B - relative limit result</li> <li>6. Lower offset B - absolute limit result</li> <li>7. Upper offset B - relative limit result</li> <li>8. Upper offset B - absolute limit result</li> </ol> <p>...</p> <ol style="list-style-type: none"> <li>21. Lower offset F - relative limit result</li> <li>22. Lower offset F - absolute limit result</li> <li>23. Upper offset F - relative limit result</li> <li>24. Upper offset F - absolute limit result</li> <li>25. Inside Adjacent Channel - relative limit result</li> <li>26. Inside Adjacent Channel - absolute limit result</li> <li>27. Outside Adjacent Channel - relative limit result</li> <li>28. Outside Adjacent Channel - absolute limit result</li> </ol> <p>If Radio Device = Exciter, the last four (25, 26, 27 and 28) results returned -999.0.</p>
Mode = DTMB (CTTB) or CMMB, Radio BW = 8 MHz and Meas Type = Power spectral density reference	n = 3	<p>Returns 28 scalar values of the pass/fail (0 = passed, or 1 = failed) determined by testing the relative to the reference carrier and by testing the absolute power limit of the offset frequencies (measured as power spectral density in dB):</p> <ol style="list-style-type: none"> <li>1. Lower offset A - relative limit result</li> <li>2. Lower offset A - absolute limit result</li> <li>3. Upper offset A - relative limit result</li> <li>4. Upper offset A - absolute limit result</li> <li>5. Lower offset B - relative limit result</li> <li>6. Lower offset B - absolute limit result</li> <li>7. Upper offset B - relative limit result</li> </ol>

Condition	N	Results Returned
		8. Upper offset B - absolute limit result ... 21. Lower offset F - relative limit result 22. Lower offset F - absolute limit result 23. Upper offset F - relative limit result 24. Upper offset F - absolute limit result 25. -999.0 26. -999.0 27. -999.0 28. -999.0 The last four results always returned -999.0.
Meas Type = Total power reference	n = 3	Returns 24 scalar values of the pass/fail (0 = passed, or 1 = failed) determined by testing the relative to the reference carrier and by testing the absolute power limit of the offset frequencies (measured as total power in dB): 1. Lower offset A - relative limit result 2. Lower offset A - absolute limit result 3. Upper offset A - relative limit result 4. Upper offset A - absolute limit result 5. Lower offset B - relative limit result 6. Lower offset B - absolute limit result 7. Upper offset B - relative limit result 8. Upper offset B - absolute limit result ... 21 Lower offset F - relative limit result 22 Lower offset F - absolute limit result 23 Upper offset F - relative limit result 24 Upper offset F - absolute limit result When in MSR and LTE-Advanced FDD/TDD, this trace includes only outer offset results.
Meas Type = Power spectral density reference	n = 3	Returns 24 scalar values of the pass/fail (0 = passed, or 1 = failed) determined by testing the relative to the reference carrier and by testing the absolute power limit of the offset frequencies (measured as power spectral density in dB): 1. Lower offset A - relative limit result 2. Lower offset A - absolute limit result 3. Upper offset A - relative limit result 4. Upper offset A - absolute limit result 5. Lower offset B - relative limit result 6. Lower offset B - absolute limit result 7. Upper offset B - relative limit result 8. Upper offset B - absolute limit result

Condition	N	Results Returned
		... 21 Lower offset F - relative limit result 22 Lower offset F - absolute limit result 23 Upper offset F - relative limit result 24 Upper offset F - absolute limit result When in MSR and LTE-Advanced FDD/TDD, this trace includes only outer offset results.
	n = 4	Returns <Num Pts> comma-separated scalar values representing the Y values in Trace 1
	n = 5	Returns <Num Pts> comma-separated scalar values representing the Y values in Trace 2
	n = 6	Returns <Num Pts> comma-separated scalar values representing the Y values in Trace 3
Meas Type = Total power reference	n = 7	Returns (2 * Number of Carriers) scalar results, in the following order: The Number of Carriers is the value filled in Carriers under Carrier Setup menu. If license N9060A-5FP is enabled, max value of Number of Carriers is 18, otherwise, max value of Number of Carriers is 12. In MSR mode, max value of Number of Carriers is 100. In LTE-Advanced FDD/TDD mode, max value of number of carriers is 5. 1. Channel (1) - relative power (dB) 2. Channel (1) - absolute power (dBm) 3. Channel (2) - relative power (dB) 4. Channel (2) - absolute power (dBm) ... 2 * Number of Carriers -1. Channel (Number of Carriers) - relative power (dB) 2 * Number of Carriers. Channel (Number of Carriers) - absolute power (dBm) If the results are not available, 9.91E+37 is returned.
Meas Type = Power spectral density reference	n = 7	Returns (2 * Number of Carriers) scalar results, in the following order: The Number of Carriers is the value filled in Carriers under Carrier Setup menu. If license N9060A-5FP is enabled, max value of Number of Carriers is 18, otherwise, max value of Number of Carriers is 12. In MSR mode, max value of Number of Carriers is 100. In LTE-Advanced FDD/TDD mode, max value of number of carriers is 5. 1. Channel (1) - relative power (dB) 2. Channel (1) - absolute power (dBm/Hz or dBm/MHz) 3. Channel (2) - relative power (dB) 4. Channel (2) - absolute power (dBm/Hz or dBm/MHz) ... 2 * Number of Carriers -1. Channel (Number of Carriers) - relative power (dB) 2 * Number of Carriers. Channel (Number of Carriers) - absolute power (dBm/Hz or dBm/MHz)

Condition	N	Results Returned
If the results are not available, 9.91E+37 is returned		
Mode = MSR,LTEAFDD,LTEATDD	n = 8	<p>Returns scalar results, in the following order:</p> <ol style="list-style-type: none"> <li>1. 0.0</li> <li>2. Total carrier power (dBm)</li> <li>3. 0.0</li> <li>4. Reference carrier power (dBm, dBm/Hz or dBm/MHz)</li> <li>5. Inner Lower offset A - relative power (dB)</li> <li>6. Inner Lower offset A - absolute power (dBm, dBm/Hz or dBm/MHz)</li> <li>7. Inner Upper offset A - relative power (dB)</li> <li>8. Inner Upper offset A - absolute power (dBm, dBm/Hz or dBm/MHz)</li> <li>9. Inner Lower offset B - relative power (dB)</li> <li>10. Inner Lower offset B - absolute power (dBm, dBm/Hz or dBm/MHz)</li> <li>11. Inner Upper offset B - relative power (dB)</li> <li>12. Inner Upper offset B - absolute power (dBm, dBm/Hz or dBm/MHz)</li> </ol> <p>...</p> <ol style="list-style-type: none"> <li>25. Inner Lower offset F - relative power (dB)</li> <li>26. Inner Lower offset F - absolute power (dBm, dBm/Hz or dBm/MHz)</li> <li>27. Inner Upper offset F - relative power (dB)</li> <li>28. Inner Upper offset F - absolute power (dBm, dBm/Hz or dBm/MHz)</li> </ol> <p>When Power Ref is either Left &amp; Right Carriers or Max Power Carrier in Sub-block, the first four values are</p> <ol style="list-style-type: none"> <li>1. 0.0</li> <li>2. Total carrier power (dBm)</li> <li>3. Reference carrier in the lower sub-block (dBm, dBm/Hz or dBm/MHz)</li> <li>4. Reference carrier in the upper sub-block (dBm, dBm/Hz or dBm/MHz)</li> </ol> <p>Unit of absolute power results.            dBm: Meas Type = Total Pwr Ref            dBm/Hz: Meas Type = PSD Ref, PSD Unit = dBm/Hz            dBm/MHz: Meas Type = PSD Ref, PSD Unit = dBm/MHz</p> <p>If the results are not available, 9.91E+37 is returned.</p>
Mode = MSR, LTEAFDD,LTEATDD	n = 9	<p>Returns scalar values of the pass/fail (0 = passed, or 1 = failed) determined by testing the relative to the reference carrier and by testing the absolute power limit of the offset frequencies.</p> <ol style="list-style-type: none"> <li>1. Inner Lower offset A - relative limit result</li> <li>2. Inner Lower offset A - absolute limit result</li> <li>3. Inner Upper offset A - relative limit result</li> <li>4. Inner Upper offset A - absolute limit result</li> <li>5. Inner Lower offset B - relative limit result</li> <li>6. Inner Lower offset B - absolute limit result</li> </ol>



Condition	N	Results Returned
		7. Inner Upper offset B - relative limit result 8. Inner Upper offset B - absolute limit result ... 21. Inner Lower offset F - relative limit result 22. Inner Lower offset F - absolute limit result 23. Inner Upper offset F - relative limit result 24. Inner Upper offset F - absolute limit result
Mode = MSR, LTEAFDD,LTEATDD	n = 10	Returns scalar values of offset results. Numbers returned in this trace is 10 x actually measured offsets. Note that upper and lower sides of an offset are returned separately. For example, when only outer offset A is measured with offset side both, $10 \times 2 = 20$ values are returned. 1. Inner = 1 or Outer = 2. 2. Offset A~F. (A=1, B=2, ... F=6) 3. Offset Side. Lower=1 or Upper=2 4. Relative power or relative PSD (dBc or dB) 5. Absolute power (dBm) or absolute PSD (dBm/Hz or dBm/MHz) 6. Reference power (dBm) or reference PSD (dBm/Hz or dBm/MHz) 7. Reference Index 1 8. Reference Index 2 9. 0 (Reserved) 10. 0 (Reserved) ... 10(n-1)+1. Inner = 1 or Outer = 2. 10(n-1)+2. Offset A~F. (A=1, B=2, ... F=6) 10(n-1)+3. Offset Side. Lower=1 or Upper=2 10(n-1)+4. Relative power or relative PSD (dBc or dB) 10(n-1)+5. Absolute power (dBm) or absolute PSD (dBm/Hz or dBm/MHz) 10(n-1)+6. Reference power (dBm) or reference PSD (dBm/Hz or dBm/MHz) 10(n-1)+7. Reference Index 1 10(n-1)+8. Reference Index 2 10(n-1)+9. 0 (Reserved) 10(n-1)+10. 0 (Reserved) Where n is number of offsets. Meas Type determines which type of power result is returned, i.e. power or PSD. Unit for PSD results is determined by PSD Unit. If result is not available, 9.91E+37 is returned.

Key Path	Front-panel key
Initial S/W Revision	Prior to A.02.00
Modified at S/W Revision	A.13.00

## AMPTD Y Scale

Accesses a menu of functions that enable you to set the vertical scale parameters. The parameter values are measurement independent, except all Attenuation values and the Internal Preamp selections, which are the same across all measurements.

Key Path	Front-panel key
Initial S/W Revision	Prior to A.02.00

### Ref Value

Sets the value for the absolute power reference. However, since the Auto Scaling is defaulted to On, this value is automatically determined by the measurement result. When you set a value manually, Auto Scaling automatically changes to Off.

Key Path	AMPTD Y Scale
Mode	SA, WCDMA, C2K, WIMAX OFDMA, TD-SCDMA, 1xEVDO, DVB-T/H, DTMB (CTTB), ISDB-T, CMMB, LTE, LTE-TDD, Digital Cable TV, MSR, LTEAFDD, LTEATDD
<b>Remote Command</b>	:DISPlay:ACP:Power:VIEW[1]:WINDow[1]:TRACe:Y[:SCALe]:RLEVel <real> :DISPlay:ACP:Power:VIEW[1]:WINDow[1]:TRACe:Y[:SCALe]:RLEVel?
<b>Example</b>	DISP:ACP:VIEW:WIND:TRAC:Y:RLEV 100 DISP:ACP:VIEW:WIND:TRAC:Y:RLEV?
Notes	You must be in the mode that includes ACP measurements to use this command. Use :INSTrument:SElect to set the mode.
Couplings	When the Auto Scaling is On, this value is automatically determined by the measurement result. When you set a value manually, Auto Scaling automatically changes to Off.
Preset	10dBm
State Saved	Saved in instrument state.
Min	-250.00 dBm
Max	250.00 dBm
Initial S/W Revision	Prior to A.02.00
Modified at S/W Revision	A.02.00, A.03.00

### Range

The Range menu allows setting amplitude controls of the instrument.

Key Path	AMPTD Y Scale
Scope	Meas Global
Initial S/W Revision	A.12.50

## Range

Represents the amplitude of the largest sinusoidal signal that could be present within the IF without being clipped by the ADC. For signals with high peak-to-average ratios, the range may need to exceed the rms signal power by a fair amount to avoid clipping.

Key Path	Range
Mode	BASIC
Remote Command	<code>[ :SENSe ] :POWer [ :RF ] :RANGe &lt;real&gt;</code> <code>[ :SENSe ] :POWer [ :RF ] :RANGe?</code>
Example	<code>:POW:RANG 10.0</code> <code>:POW:RANG?</code>
Notes	The MIN and MAX values are affected by the External Gain parameters, and by the Center Frequency. (The hardware compensates for frequency response and alters the Range setting.)
Preset	0
State Saved	Saved in instrument state.
Min	-100
Max	100
Initial S/W Revision	A.12.50

## Adjust Range For Min Clip

Sets the combination of attenuation and gain based on the current measured signal level so that clipping will be at a minimum.

This is an "immediate action" function, that is, it executes once, when the key is pressed.

This key is grayed out in measurements that do not support this functionality.

Key Path	AMPTD Y Scale, Attenuation
Remote Command	<code>[ :SENSe ] :POWer [ :RF ] :RANGe:OPTimize IMMEDIATE</code>
Initial S/W Revision	Prior to A.02.00
Modified at S/W Revision	A.03.00

## Pre-Adjust for Min Clip

If this function is on, it does the adjustment described under Adjust Range For Min Clip each time a measurement restarts. Therefore, in Continuous measurement mode, it only executes before the first measurement.

Key Path	AMPTD Y Scale, Attenuation
Remote Command	<code>[ :SENSe ] :POWer [ :RF ] :RANGe:OPTimize:ATTenuation OFF   ON   ELEctrical   COMBined</code>

	<code>[ :SENSe ] :POWer [ :RF ] :RANGe:OPTimize:ATTenuation?</code>
Notes	This parameter is shared with old XA platform which uses AutoAtten. To keep the backward compatibility, ELECTrical and COMBined still can be used. Then, upon receiving ELECTrical and COMBined, these enums will be interpreted as aliases of ON. Then, when queried, ON will be returned.
Preset	OFF for Swept SA measurement; ON for all other measurements that support Pre-Adjust for Min Clip
State Saved	Saved in instrument state
Initial S/W Revision	Prior to A.02.00
Modified at S/W Revision	A.03.00

## Peak to Average

The Peak to Average Ratio is used with the Range setting to optimize the level control in the instrument. The value is the ratio, in dB, of the peak power to the average power of the signal to be measured. A ratio of 0 should be used for sinusoidal signals; for 802.11g OFDM signals use 9 dB.

All Applications (Modes) will show the current value of Peak to Average ratio on the softkey. However, some applications will not permit changing the value. In these situations the softkey will be grayed-out.

Key Path	AMPTD Y Scale, Range
Remote Command	<code>[ :SENSe ] :POWer [ :RF ] :RANGe:PARatio &lt;real&gt;</code> <code>[ :SENSe ] :POWer [ :RF ] :RANGe:PARatio?</code>
Example	POW:RANG:PAR 12 dB
Notes	In some Applications (Modes) this parameter will be read-only; meaning the value will appear on the softkey and query via SCPI, but not changeable. In such applications the softkey will be grayed-out. Attempting to change the value via SCPI will be ignored and no error message will be generated.
Preset	10 dB
State Saved	Saved in instrument state
Min	0 dB
Max	20 dB
Initial S/W Revision	A.13.00

## Mixer Level Offset

Mixer level offset is an advanced setting to adjust target Range at the input mixer which in turn affects the signal level in the instrument's IF. This setting can be used when additional optimization is needed after setting Peak to Average ratio. Positive values of offset optimize noise performance over distortion, negative values optimize distortion performance over noise.

Key Path	AMPTD Y Scale, Range
Remote Command	<code>[ :SENSe ] :POWer [ :RF ] :RANGe:MIXer:OFFSet &lt;real&gt;</code>

	<code>[ :SENSe ] :POWeR [ :RF ] :RANGe :MIXer :OFFSet ?</code>
<b>Example</b>	<code>POW:RANG:MIX:OFFS -5 dB</code>
Preset	0 dB
State Saved	Saved in instrument state
Min	-35 dB
Max	30 dB
Initial S/W Revision	A.13.00

## Scale/Div

Sets the units-per-division of the vertical scale in the logarithmic display. However, since the Auto Scaling is defaulted to On, this value is automatically determined by the measurement result. When you set a value manually, Auto Scaling automatically changes to Off.

Key Path	AMPTD Y Scale
Mode	SA, WCDMA, C2K, WIMAX OFDMA, TD-SCDMA, 1xEVDO, DVB-T/H, DTMB (CTTB), ISDB-T, CMMB, LTE, LTE-TDD, Digital Cable TV, MSR, LTEAFDD, LTEATDD
Remote Command	<code>:DISPlay:ACPower:VIEW[1]:WINDow[1]:TRACe:Y[:SCALe]:PDIVision &lt;rel_ampl&gt;</code> <code>:DISPlay:ACPower:VIEW[1]:WINDow[1]:TRACe:Y[:SCALe]:PDIVision?</code>
Example	<code>DISP:ACP:VIEW:WIND:TRAC:Y:PDIV 5</code> <code>DISP:ACP:VIEW:WIND:TRAC:Y:PDIV?</code>
Notes	You must be in the mode that includes ACP measurements to use this command. Use <code>:INSTrument:SElect</code> to set the mode.
Couplings	When the Auto Scaling is On, this value is automatically determined by the measurement result. When you set a value manually, Auto Scaling automatically changes to Off.
Preset	10.00 dB
State Saved	Saved in instrument state.
Min	0.10 dB
Max	20.00 dB
Initial S/W Revision	Prior to A.02.00
Modified at S/W Revision	A.02.00, A.03.00

## Ref Position

Positions the reference level at the top, center, or bottom of the Y- scale display. Changing the reference position does not change the reference level value.

Key Path	AMPTD Y Scale
Mode	SA, WCDMA, C2K, WIMAX OFDMA, TD-SCDMA, 1xEVDO, DVB-T/H, DTMB (CTTB), ISDB-T, CMMB, LTE, LTE-TDD, Digital Cable TV, MSR, LTEAFDD, LTEATDD

<b>Remote Command</b>	:DISPlay:ACPower:VIEW[1]:WINDow[1]:TRACe:Y[:SCALe]:RPOSition TOP   CENTER   BOTTom  :DISPlay:ACPower:VIEW[1]:WINDow[1]:TRACe:Y[:SCALe]:RPOSition?
<b>Example</b>	DISP:ACP:VIEW:WIND:TRAC:Y:RPOS CENT DISP:ACP:VIEW:WIND:TRAC:Y:RPOS?
Notes	You must be in the mode that includes ACP measurements to use this command. Use :INSTrument:SElect to set the mode.
Preset	TOP
State Saved	Saved in instrument state.
Range	Top Ctr Bot
Initial S/W Revision	Prior to A.02.00
Modified at S/W Revision	A.02.00, A.03.00

## Auto Scaling

Toggles the Auto Scaling function between On and Off.

<b>Key Path</b>	AMPTD Y Scale
Mode	SA, WCDMA, C2K, WIMAX OFDMA, TD-SCDMA, 1xEVDO, DVB-T/H, DTMB (CTTB), ISDB-T, CMMB, LTE, LTEFDD, Digital Cable TV, MSR, LTEAFDD,LTEATDD
<b>Remote Command</b>	:DISPlay:ACPower:VIEW[1]:WINDow[1]:TRACe:Y[:SCALe]:COUPle 0   1   OFF   ON  :DISPlay:ACPower:VIEW[1]:WINDow[1]:TRACe:Y[:SCALe]:COUPle?
<b>Example</b>	DISP:ACP:VIEW:WIND:TRAC:Y:COUP ON DISP:ACP:VIEW:WIND:TRAC:Y:COUP?
Notes	You must be in the mode that includes ACP measurements to use this command. Use :INSTrument:SElect to set the mode.
Couplings	When Auto Scaling is On and the Restart front-panel key is pressed, this function automatically determines the scale per division and reference values based on the measurement results.  When you set a value to either Scale/Div or Ref Value manually, Auto Scaling automatically changes to Off.
Preset	ON
State Saved	Saved in instrument state.
Range	On Off
Initial S/W Revision	Prior to A.02.00
Modified at S/W Revision	A.02.00, A.03.00

## Auto Couple

The Auto Couple feature provides a quick and convenient way to automatically couple multiple instrument settings. This helps ensure accurate measurements and optimum dynamic range. When the Auto Couple feature is activated, either from the front panel or remotely, all parameters of the current measurement that have an Auto/Manual mode are set to Auto mode and all measurement settings dependent on (or coupled to) the Auto/Man parameters are automatically adjusted for optimal performance.

However, the Auto Couple key actions are confined to the current measurement only. It does not affect other measurements in the mode, and it does not affect markers, marker functions, or trace or display attributes.

See "[More Information](#)" on page 572

<b>Key Path</b>	Front-panel key
<b>Remote Command</b>	:COUPLe ALL NONE
<b>Example</b>	:COUP ALL
<b>Notes</b>	:COUPLe ALL puts all Auto/Man parameters in Auto mode (equivalent to pressing the Auto Couple key). :COUPLE NONE puts all Auto/Man parameters in manual mode. It decouples all the coupled instrument parameters and is not recommended for making measurements.
<b>Initial S/W Revision</b>	Prior to A.02.00

### More Information

There are two types of functions that have Auto/Manual modes.

#### Auto/Man Active Function keys

An Auto/Man toggle key controls the binary state associated with an instrument parameter by toggling between Auto (where the parameter is automatically coupled to the other parameters it is dependent upon) and Man (where the parameter is controlled independent of the other parameters), as well as making the parameter the active function. The current mode is indicated on the softkey with either Auto or Man underlined as illustrated below.

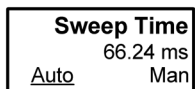

vsd07

#### Auto/Man 1-of-N keys

An Auto/Man 1-of-N key allows you to manually pick from a list of parameter values, or place the function in Auto, in which case the value is automatically selected (and indicated) as shown below. If in Auto, Auto is underlined on the calling key. If in manual operation, manual is indicated on the calling key. But the calling key does not actually toggle the function, it simply opens the menu.



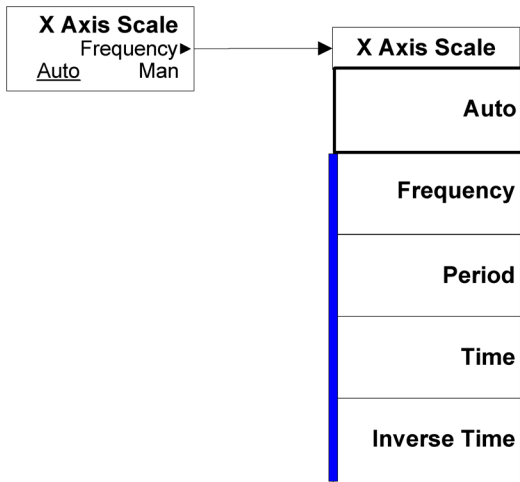

vsd08

## BW

Accesses a menu of functions that enable you to specify and control the video and resolution bandwidths. You can also select the type of filter for the measurement and set the filter bandwidth.

Key Path	Front-panel key
Initial S/W Revision	Prior to A.02.00

## Res BW

Sets the value of the resolution bandwidth. If an unavailable bandwidth is entered with the numeric keypad, the closest available bandwidth is selected.

LTE-Advanced FDD/TDD Auto RBW:

Bandwidth	RBW (KHz)
1.4MHz	51KHz
3MHz	
5MHz	100 KHz
10MHz	
15MHz	
20MHz	

the resolution bandwidth is predefined based on the corresponding bandwidth of the single LTE carrier, which is listed above. When ResBW mode is Auto, the narrowest RBW over the active carriers is selected for Multi-carriers.

Key Path	BW
Mode	SA, WCDMA, C2K, WIMAX OFDMA, TD-SCDMA, 1xEVDO, DVB-T/H, DTMB (CTTB), ISDB-T, CMMB, LTE, LTE-TDD, Digital Cable TV, MSR, LTEAFDD, LTEATDD
Remote Command	[:SENSe]:ACPower:BANDwidth[:RESolution] <freq> [:SENSe]:ACPower:BANDwidth[:RESolution]? [:SENSe]:ACPower:BANDwidth[:RESolution]:AUTO ON OFF 1 0 [:SENSe]:ACPower:BANDwidth[:RESolution]:AUTO?
Example	ACP:BAND 25kHz ACP:BAND? ACP:BAND:AUTO ON ACP:BAND:AUTO?
Notes	This key is available only in IBW mode. This parameter is preset by the Meas Method selection. Preset values are as follows: IBW: 100 kHz

	IBWR: 27 kHz FAST (WCDMA): 390 kHz You must be in the mode that includes ACP measurements to use this command. Use :INSTrument:SElect to set the mode.
Dependencies	When Meas Method is RBW or FAST, this key is grayed out and disabled. If the key is pressed, an advisory message is generated. If the equivalent remote command is sent, a "Setting conflict" warning is generated.
Couplings	The resolution bandwidth is coupled to the video bandwidth based on the video to resolution bandwidth ratio setting if AUTO is selected.
Preset	SA: 220 kHz WCDMA: 100 kHz WIMAX OFDMA: 100 kHz C2K: 15 kHz TD-SCDMA: 30 kHz 1xEVDO: 30 kHz DVB-T/H: 39 kHz DTMB (CTTB): 39 kHz ISDB-T: 39 kHz CMMB: 39 kHz LTE: 100 kHz LTETDD: 100 kHz Digital Cable TV: 39 kHz MSR: 100 kHz LTEAFDD, LTEATDD: 100kHz LTE, LTETDD, LTEAFDD, LTEATDD: 1 Others:0
State Saved	Saved in instrument state.
Min	1 Hz
Max	8 MHz
<b>Backwards Compatibility SCPI</b>	[ :SENSe ] :ACP:Power:BWIDth [ :RESolution ] [ :SENSe ] :ACP:SWEp:Bandwidth BWIDth [ :RESolution ] (PSA W-CDMA, PSA cdma2000 )
Initial S/W Revision	Prior to A.02.00
Modified at S/W Revision	A.02.00, A.03.00

## Video BW

Changes the analyzer post-detection filter (VBW).

Key Path	BW
Mode	SA, WCDMA, C2K, WIMAX OFDMA, TD-SCDMA, 1xEVDO, DVB-T/H, DTMB (CTTB), ISDB-T, CMMB,

	LTE, LTETDD, Digital Cable TV, MSR, LTEAFDD, LTEATDD
<b>Remote Command</b>	[:SENSe]:ACPower:BANDwidth:VIDeo <freq> [:SENSe]:ACPower:BANDwidth:VIDeo? [:SENSe]:ACPower:BANDwidth:VIDeo:AUTO OFF ON 0 1 [:SENSe]:ACPower:BANDwidth:VIDeo:AUTO?
<b>Example</b>	ACP:BAND:VID 1kHz ACP:BAND:VID? ACP:BWID:VID:AUTO ON ACP:BWID:VID:AUTO?
<b>Notes</b>	The values shown in this table reflect the conditions after a Mode Preset.
<b>Dependencies</b>	When Meas Method is RBW or FAST, this key is grayed out and disabled. If the key is pressed, an advisory message is generated. If the equivalent remote command is sent, a "Setting conflict" warning is generated.
<b>Preset</b>	SA: 22 kHz WCDMA, WIMAX OFDMA: 1 MHz C2K: Method RBW: grayed out (1.2 MHz) Method IBW: 150 kHz TD-SCDMA: 300 kHz 1xEVDO: 300 kHz DVB-T/H: 390 kHz DTMB (CTTB): 390 kHz ISDB-T: 390 kHz CMMB: 390 kHz LTE, LTETDD, MSR: Auto LTETDD: 1 MHz Digital Cable TV: 390 kHz LTEAFDD, LTEATDD: Auto SA: ON WCDMA: OFF WIMAX OFDMA: OFF TD-SCDMA: OFF DVB-T/H: OFF DTMB (CTTB): OFF CDMA1xEVDO: OFF ISDB-T: OFF CMMB: OFF LTE, MSR: ON LTETDD: ON Digital Cable TV: OFF

	LTEAFDD, LTEATDD: ON
State Saved	Saved in instrument state.
Min	1 Hz
Max	50 MHz
<b>Backwards Compatibility SCPI</b>	[ :SENSe ] :ACPower :BWIDth :VIDeo
Initial S/W Revision	Prior to A.02.00
Modified at S/W Revision	A.02.00, A.03.00

## RBW Control

Accesses a menu that enables you to select the filter bandwidth and type.

Key Path	BW
Initial S/W Revision	Prior to A.02.00

## Filter Type

Selects the type of bandwidth filter that is used. The choices are Gaussian or Flat top.

Key Path	BW, RBW Control
Mode	SA, WCDMA, C2K, WIMAX OFDMA, TD-SCDMA, 1xEVDO, DVB-T/H, DTMB (CTTB), ISDB-T, CMMB, LTE, LTE-TDD, Digital Cable TV, MSR, LTEAFDD, LTEATDD
<b>Remote Command</b>	[ :SENSe ] :ACPower :BANDwidth :SHAPE GAUSSian   FLATtop [ :SENSe ] :ACPower :BANDwidth :SHAPE?
<b>Example</b>	ACP:BAND:SHAP GAUS ACP:BAND:SHAP?
Dependencies	When Meas Method is FAST, this key is grayed out and disabled. If the key is pressed, an advisory message is generated. If the equivalent remote command is sent, a "Setting conflict" warning is generated.
Preset	GAUSSian C2K: FLATtop
State Saved	Saved in instrument state.
Range	Gaussian (Normal) Flattop
<b>Backwards Compatibility SCPI</b>	[ :SENSe ] :ACPower :BWIDth :SHAPE
Initial S/W Revision	Prior to A.02.00
Modified at S/W Revision	A.02.00, A.03.00

## Filter BW

Selects a Gaussian filter based on its -3 dB (Normal) bandwidth or its -6 dB bandwidth.

Key Path	BW, RBW Control
Mode	SA, WCDMA, C2K, WIMAX OFDMA, TD-SCDMA, 1xEVDO, DVB-T/H, DTMB (CTTB), ISDB-T, CMMB, LTE, LTE-TDD, Digital Cable TV, MSR, LTEAFDD, LTEATDD
<b>Remote Command</b>	<code>[ :SENSe ] :ACPower:BAWdwidth:TYPE DB3 DB6</code> <code>[ :SENSe ] :ACPower:BAWdwidth:TYPE?</code>
<b>Example</b>	ACP:BAND:TYPE DB3 ACP:BAND:TYPE?
Dependencies	When Filter Type is Flattop or Meas Method is RBW or FAST, this key is grayed out and disabled. If the key is pressed, an advisory message is generated. If the equivalent remote command is sent, a "Setting conflict" warning is generated.
Preset	DB3
State Saved	Saved in instrument state.
Range	-3 dB (Normal) -6 dB
<b>Backwards Compatibility SCPI</b>	<code>[ :SENSe ] :ACPower:BWIDth:TYPE</code>
Initial S/W Revision	Prior to A.02.00
Modified at S/W Revision	A.02.00, A.03.00

## Cont (Continuous Measurement/Sweep)

Sets the analyzer for Continuous measurement operation. The single/continuous state is Meas Global so the setting will affect all measurements. If you are Paused, pressing Cont does a Resume.

Key Path	Front-panel key
Remote Command	:INITiate:CONTinuous OFF ON 0 1 :INITiate:CONTinuous?
Example	:INIT:CONT 0 puts analyzer in Single measurement operation. :INIT:CONT 1 puts analyzer in Continuous measurement operation
Preset	ON (Note that SYST:PRESet sets INIT:CONT to ON but *RST sets INIT:CONT to OFF)
State Saved	Saved in instrument state
Backwards Compatibility Notes	For Spectrum Analysis mode in ESA and PSA, there is no Cont hardkey, instead there is a Sweep Single/Cont key. In these analyzers, switching the Sweep Single/Cont key from Single to Cont restarts averages (displayed average count reset to 1), but does not restart Max Hold and Min Hold. The X-Series has Single and Cont keys in place of the SweepSingleCont key. In the X-Series, if in single measurement, the Cont key (and INIT:CONT ON ) switches to continuous measurement, but never restarts a measurement and never resets a sweep.
Initial S/W Revision	Prior to A.02.00

In Swept SA Measurement (Spectrum Analysis Mode):

The analyzer takes repetitive sweeps, averages, measurements, etc., when in Continuous mode. When the average count reaches the Average/Hold Number the count stops incrementing, but the analyzer keeps sweeping. See the Trace/Detector section for the averaging formula used both before and after the Average/Hold Number is reached. The trigger condition must be met prior to each sweep. The type of trace processing for multiple sweeps, is set under the Trace/Detector key, with choices of Trace Average, Max Hold, or Min Hold.

In Other Measurements/Modes:

With Avg/Hold Num (in the Meas Setup menu) set to Off or set to On with a value of 1, a sweep is taken after the trigger condition is met; and the analyzer continues to take new sweeps after the current sweep has completed and the trigger condition is again met. However, with Avg/Hold Num set to On with a value >1, multiple sweeps (data acquisitions) are taken for the measurement. The trigger condition must be met prior to each sweep. The sweep is not stopped when the average count k equals the number N set for Avg/Hold Num is reached, but the number k stops incrementing. A measurement average usually applies to all traces, marker results, and numeric results. But sometimes it only applies to the numeric results.

If the analyzer is in Single measurement, pressing the Cont key does not change k and does not cause the sweep to be reset; the only action is to put the analyzer into Continuous measurement operation.

If it is already in continuous sweep:

the INIT:CONT 1 command has no effect

9 ACP Measurement  
Cont (Continuous Measurement/Sweep)

the INIT:CONT 0 command will place the analyzer in Single Sweep but will have no effect on the current sequence until  $k = N$ , at which point the current sequence will stop and the instrument will go to the idle state.



File

See "File" on page 178

## FREQ Channel

Accesses a menu of keys that allow you to control the Frequency and Channel parameters of the instrument.

Some features in the Frequency menu are the same for all measurements – they do not change as you change measurements. Settings like these are called “Meas Global” and are unaffected by Meas Preset. For example, the Center Freq setting is the same for all measurements - it does not change as you change measurements.

<b>Key Path</b>	<b>Front-panel key</b>
<b>Initial S/W Revision</b>	<b>Prior to A.02.00</b>

### Center Freq

Sets the frequency that corresponds to the horizontal center of the graticule (when frequency Scale Type is set to linear). While adjusting the Center Frequency the Span is held constant, which means that both Start Frequency and Stop Frequency will change.

Pressing Center Freq also sets the frequency entry mode to Center/Span. In Center/Span mode, the center frequency and span values are displayed below the graticule, and the default active function in the Frequency menu is Center Freq.

The center frequency setting is the same for all measurements within a mode, that is, it is Meas Global. Some modes are also able to share a Mode Global center frequency value. If this is the case, the Mode will have a Global Settings key in its Mode Setup menu.

The Center Freq function sets (and queries) the Center Frequency for the currently selected input. If your analyzer has multiple inputs, and you select another input, the Center Freq changes to the value for that input. SCPI commands are available to directly set the Center Freq for a specific input.

Center Freq is remembered as you go from input to input. Thus you can set a Center Freq of 10 GHz with the RF Input selected, change to BBIQ and set a Center Freq of 20 MHz, then switch to External Mixing and set a Center Freq of 60 GHz, and when you go back to the RF Input the Center Freq will go back to 10 GHz; back to BBIQ and it is 20 MHz; back to External Mixing and it is 60 GHz.

See ["RF Center Freq" on page 585](#)

See [Ext Mix Center Freq](#)

See ["I/Q Center Freq" on page 587](#)

See ["Center Frequency Presets" on page 583](#)

<b>Key Path</b>	<b>FREQ Channel</b>
<b>Scope</b>	<b>Meas Global</b>
<b>Remote Command</b>	<code>[ :SENSe ] :FREQuency:CENTer &lt;freq&gt;</code> <code>[ :SENSe ] :FREQuency:CENTer?</code>
<b>Example</b>	<code>FREQ:CENT 50 MHz</code>

	FREQ:CENT UP changes the center frequency to 150 MHz if you use FREQ:CENT:STEP 100 MHz to set the center frequency step size to 100 MHz FREQ:CENT?
Notes	This command sets either the RF or I/Q Center Frequency depending on the selected input. For RF input it is equivalent to FREQ:RF:CENT For I/Q input it is equivalent to FREQ:IQ:CENT Preset and Max values are dependent on Hardware Options (5xx) If no terminator (e.g. MHz) is sent the terminator Hz is used. If a terminator with unit other than Frequency is used, an invalid suffix error message is generated.
Dependencies	The Center Frequency can be limited by Start or Stop Freq limits, if the Span is so large that Start or Stop reach their limit.
Couplings	When operating in "swept span", any value of the Center Frequency or Span that is within the frequency range of the analyzer is allowed when the value is being set through the front panel numeric key pad or the SCPI command. The other parameter is forced to a different value if needed, to keep the Start and the Stop Frequencies within the analyzer's frequency range
Preset	Depends on instrument maximum frequency, mode, measurement, and selected input. See "Center Frequency Presets" on page 583 and "RF Center Freq" on page 585 and Ext Mix Center Freq and "I/Q Center Freq" on page 587.
State Saved	Saved in instrument state
Min	Depends on instrument maximum frequency, mode, measurement, and selected input.. See "Center Frequency Presets" on page 583 and "RF Center Freq" on page 585 and "I/Q Center Freq" on page 587.
Max	Depends on instrument maximum frequency, mode, measurement, and selected input.. See "Center Frequency Presets" on page 583 and "RF Center Freq" on page 585 and "I/Q Center Freq" on page 587.
Default Unit	Hz
Status Bits/OPC	Non-overlapped
Dependencies	
Initial S/W Revision	Prior to A.02.00

## Center Frequency Presets

The following table provides the Center Frequency Presets for the Spectrum Analyzer mode, and the Max Freq, for the various frequency options:

Freq Option	CF after Mode Preset	Stop Freq after Mode Preset	Max Freq (can't tune above)

9 ACP Measurement  
FREQ Channel

503 (all but N9000A)	1.805 GHz	3.6 GHz	3.7 GHz
503 (N9000A)	1.505 GHz	3.0 GHz	3.08 GHz
504 (M9420A)	1 GHz	3.8GHz	3.88 GHz
506 (M9420A)	1 GHz	6.0GHz	6.08 GHz
507 (all but N9000A)	3.505 GHz	7.0 GHz	7.1 GHz
507 (N9000A)	3.755 GHz	7.5 GHz	7.58 GHz
508 (all but N9038A)	1.805 GHz	3.6 GHz	8.5 GHz
508 (N9038A)	4.205 GHz	8.4 GHz	8.5 GHz
513	6.805 GHz	13.6 GHz	13.8 GHz
526 (all but N9000A and N9038A)	13.255 GHz	26.5 GHz	27.0 GHz
526 (N9000A)	13.255 GHz	26.5 GHz	26.55 GHz
526 (N9038A)	1.805 GHz	3.6 GHz	27.0 GHz
532	16.005 GHz	32.0 GHz	32.5 GHz
543	21.505 GHz	43.0 GHz	TBD
544	22.005 GHz	44.0 GHz	44.5 GHz
550	25.005 GHz	50.0 GHz	51 GHz

Input 2:

Model	CF after Mode Preset	Stop Freq after Mode Preset	Max Freq (can't tune above)
N9000A opt C75	0.7505GHz	1.5 GHz	1.58 GHz
N9038A	505 MHz	1 GHz	1.000025 GHz

Tracking Generator Frequency Limits (N9000A only):

Tracking Generator Option	Min Freq (clips to this freq when turn TG on and can't tune below while TG on)	If above this Freq, Stop Freq clipped to this Freq when TG turned on	Max Freq (can't tune above) while TG on
T03	9 kHz	3.0 GHz	3.08 GHz
T06	9 kHz	6.0 GHz	6.05 GHz

The following table shows the Center Frequency Presets for modes other than Spectrum Analyzer:

Mode	CF Preset for RF
WCDMA	1 GHz
WIMAXOFDMA,	1 GHz
BASIC	1 GHz
ADEMOD	1 GHz
VSA	1 GHz
TDSCDMA	1 GHz
PNOISE	1 GHz
LTE	1 GHz
LTETDD	1 GHz
MSR	1 GHz
GSM	935.2 MHz
NFIGURE	1.505 GHz

## RF Center Freq

SCPI command for specifying the RF Center Frequency. This command will set the Center Frequency to be used when the RF input is selected, even if the RF input is not the input that is selected at the time the command is sent. Note that the Center Freq function in the Frequency menu on the front panel always applies to the currently selected input.

Scope	Meas Global
<b>Remote Command</b>	<code>[ :SENSe ] :FREQuency:RF:CENTer &lt;freq&gt;</code> <code>[ :SENSe ] :FREQuency:RF:CENTer?</code>
<b>Example</b>	FREQ:RF:CENT 30 MHz
Notes	This command is the same in all modes, but the parameter is Measurement Global. So the value is independent in each mode and common across all the measurements in the mode.
Dependencies	If the electronic/soft attenuator is enabled, any attempt to set Center Frequency such that the Stop Frequency would be >3.6 GHz fails and results in an advisory message. If the equivalent SCPI

	command is sent, this same message is generated as part of a “-221, Settings conflict” warning. If Source Mode is set to Tracking, and the Max or Min Center Freq is therefore limited by the limits of the source, a warning message is generated, “Data out of range;clipped to source max/min” if these limits are exceeded. Note that for an external source, these limits can be affected by the settings of Source Numerator, Source Denominator and Power Sweep.
Preset	See table above
State Saved	Saved in instrument state.
Min	-79.999995 MHz, unless Source Mode is set to Tracking, in which case it is limited by the minimum frequency of the Source
Max	See table above. Basically instrument maximum frequency – 5 Hz. Note that, if the Source Mode is set to Tracking, the effective instrument maximum frequency may be limited by the source maximum frequency. If the knob or step keys are being used, also depends on the value of the other three interdependent parameters Span, Start Frequency and Stop Frequency
Initial S/W Revision	Prior to A.02.00
Modified at S/W Revision	A.03.00

## Ext Mix Center Freq

SCPI command for specifying the External Mixer Center Frequency. This command will set the Center Frequency to be used when the External Mixer is selected, even if the External Mixer input is not the input which is selected at the time the command is sent. Note that the Center Freq function in the Frequency menu on the front panel always applies to the currently selected input.

Scope	Meas Global
<b>Remote Command</b>	<code>[ :SENSE ] :FREQuency:EMIXer:CENTer &lt;freq&gt;</code> <code>[ :SENSE ] :FREQuency:EMIXer:CENTer?</code>
<b>Example</b>	<code>:FREQ:EMIX:CENT 60 GHz</code> <code>:FREQ:EMIX:CENT?</code>
Notes	This command is the same in all modes, but the parameter is Measurement Global. So the value is independent in each mode and common across all the measurements in the mode.
Couplings	When returning to External Mixing after having been switched to one of the other inputs (e.g., RF), you will come back into the settings that you had when you left External Mixing. So you will come back to the band you were in with the Center Frequency that you had. However, Span is not an input-dependent parameter, therefore you will bring the span over from the other input. Therefore, the analyzer comes back with the span from the previous input, limited as necessary by the current mixer setup.
Preset	When a Mode Preset is performed while in External Mixing, the Start frequency of the current Mode is set to the nominal Min Freq of the lowest harmonic range in the Harmonic Table for the current mixer setup. Similarly, the Stop frequency of the current Mode is set to the nominal Max Freq of the highest harmonic range in the Harmonic Table. The Center Freq thus presets to the point arithmetically equidistant from these two frequencies.

If the current measurement has a limited Span available to it, and cannot achieve the Span shown in the table (Span=Stop Freq – Start Freq), the analyzer uses the maximum Span the measurement allows, and still sets the Center Freq to the midpoint of the Start and Stop Freq values in the Harmonic Table.

When Restore Input/Output Defaults is performed, the mixer presets to the 11970A, whose Start and Stop frequencies are 26.5 and 40 GHz respectively. The center of these two frequencies is 33.25 GHz.

Therefore, after a Restore Input/Output Defaults, if you go into External Mixing and do a Mode Preset while in the Spectrum Analyzer Mode, the resulting Center Freq is 33.25 GHz.

State Saved	Saved in instrument state.
Min	The minimum frequency in the currently selected mixer band + 5 Hz
Max	The maximum frequency in the currently selected mixer band – 5 Hz If the knob or step keys are being used, also depends on the value of the other three interdependent parameters Span, Start Frequency and Stop Frequency
Initial S/W Revision	A.08.01

## I/Q Center Freq

SCPI command for specifying the I/Q Center Frequency. This command will set the Center Frequency to be used when the I/Q input is selected, even if the I/Q input is not the input which is selected at the time the command is sent. Note that the Center Freq function in the Frequency menu on the front panel always applies to the currently selected input.

Scope	Meas Global
<b>Remote Command</b>	[ :SENSe ] :FREQuency:IQ:CENTer <freq> [ :SENSe ] :FREQuency:IQ:CENTer?
<b>Example</b>	FREQ:IQ:CEN: 30 MHz
Notes	This command is the same in all modes, but the parameter is Measurement Global. So the value is independent in each mode and common across all the measurements in the mode.
Preset	0 Hz
State Saved	Saved in instrument state.
Min	-40.049995 MHz
Max	40.049995 MHz
Initial S/W Revision	Prior to A.02.00

## Input/Output

See "[Input/Output](#)" on page 118



## Marker

Accesses a menu that enables you to select, set up and control the markers for the current measurement. Note that this hard key and all sub keys are unavailable when "Meas Method" on page 656 is set to RBW.

Key Path	Front-panel key
Initial S/W Revision	Prior to A.02.00

## Select Marker

Displays 12 markers available for selection. Note that this key is unavailable when "Meas Method" on page 656 is set to RBW.

Key Path	Marker
Initial S/W Revision	Prior to A.02.00

## Marker Type

Sets the marker control mode to Normal, Delta, Fixed or Off. All interactions and dependencies detailed under the key description are enforced when the remote command is sent. If the selected marker is Off, pressing Marker sets it to Normal and places it at the center of the screen on the trace determined by the Marker Trace rules. At the same time, Marker X Axis Value appears on the Active Function area.

The default active function is the active function for the currently selected marker control mode. If the current control mode is Off, there is no active function and the active function is turned off.

Key Path	Marker
Mode	SA, WCDMA, C2K, WIMAX OFDMA, TD-SCDMA, 1xEVDO, DVB-T/H, DTMB (CTTB), ISDB-T, CMMB, LTE, LTE-TDD, Digital Cable TV, MSR, LTEAFDD, LTEATDD
Remote Command	:CALCulate:ACPower:MARKer[1] 2 ... 12:MODE POSITION   DELTa   OFF :CALCulate:ACPower:MARKer[1] 2 ... 12:MODE?
Example	CALC:ACP:MARK2:MODE DELT CALC:ACP:MARK2:MODE?
Notes	If the selected marker is Off, pressing Marker sets it to Normal and places it at the center of the screen on the trace determined by the Marker Trace rules. At the same time, Marker X Axis Value appears on the Active Function area.  Default Active Function: the active function for the selected marker's current control mode. If the current control mode is Off, there is no active function and the active function is turned off.  Active Function Display: the marker X axis value entered in the active function area will display the marker value to its full entered precision.  You must be in the mode that includes ACP measurements to use this command. Use :INSTrument:SElect to set the mode.
Dependencies	This key is unavailable when "Meas Method" on page 656 is set to RBW.

Preset	OFF OFF OFF OFF OFF OFF OFF OFF OFF OFF OFF OFF
State Saved	Saved in instrument state.
Range	Normal Delta Off
Initial S/W Revision	Prior to A.02.00
Modified at S/W Revision	A.02.00, A.03.00

## Properties

Accesses the marker properties menu. Note that this key is unavailable when "Meas Method" on page 656 is set to RBW.

Key Path	Marker
Initial S/W Revision	Prior to A.02.00

## Select Marker

Displays 12 markers available for selection. Note that this key is unavailable when "Meas Method" on page 656 is set to RBW.

Key Path	Marker
Initial S/W Revision	Prior to A.02.00

## Relative To

Selects the desired marker. The selected marker will be relative to its reference marker.

Key Path	Marker, Properties
Mode	SA, WCDMA, C2K, WIMAX OFDMA, TD-SCDMA, 1xEVDO, DVB-T/H, DTMB (CTTB), ISDB-T, CMMB, LTE, LTETDD, Digital Cable TV, MSR, LTEAFDD, LTEATDD
Remote Command	:CALCulate:ACPpower:MARKer[1] 2 ... 12:REFerence <integer> :CALCulate:ACPpower:MARKer[1] 2 ... 12:REFerence?
Example	CALC:ACP:MARK2:REF 6 CALC:ACP:MARK2:REF?
Notes	A marker cannot be relative to itself so that choice is grayed out, and if sent from a remote command, generates error -221: "Settings conflict; marker cannot be relative to itself." When queried a single value will be returned (the specified marker numbers relative marker). You must be in the mode that includes ACP measurements to use this command. Use :INSTrument:SElect to set the mode.
Dependencies	This key is unavailable when "Meas Method" on page 656 is set to RBW.

Preset	2 3 4 5 6 7 8 9 10 11 12 1
State Saved	Saved in instrument state.
Min	1
Max	12
Initial S/W Revision	Prior to A.02.00
Modified at S/W Revision	A.02.00, A.03.00

## Marker Trace

Selects the trace that you want your marker to be placed on. A marker is associated with one and only one trace. This trace is used to determine the placement, result, and X Axis Scale of the marker. All markers have an associated trace, even Fixed markers; it is from that trace that they determine their attributes and behaviors, and it is to that trace that they go when they become Normal or Delta markers.

Key Path	Marker, Properties
Mode	SA, WCDMA, C2K, WIMAX OFDMA, TD-SCDMA, 1xEVDO, DVB-T/H, DTMB (CTTB), ISDB-T, CMMB, LTE, LTE-TDD, Digital Cable TV, MSR, LTEAFDD, LTEATDD
Remote Command	:CALCulate:ACPower:MARKer[1] 2 ... 12:TRACe 1 2 3 :CALCulate:ACPower:MARKer[1] 2 ... 12:TRACe?
Example	CALC:ACP:MARK2:TRAC 2 CALC:ACP:MARK2:TRAC?
Notes	If the selected marker is Off, pressing Marker sets it to Normal and places it at the center of the screen on the trace determined by the Marker Trace rules. At the same time, Marker X Axis Value appears on the Active Function area.  Default Active Function: the active function for the selected marker's current control mode. If the current control mode is Off, there is no active function and the active function is turned off.  Active Function Display: the marker X axis value entered in the active function area will display the marker value to its full entered precision.
Dependencies	This key is unavailable when " <b>Meas Method</b> " on page 656 is set to RBW.
Couplings	This is not affected by Auto Coupling.  Sending the remote command causes the addressed marker to become selected.
Preset	All Markers Off
State Saved	Saved in instrument state.
Range	1 2 3
Initial S/W Revision	Prior to A.02.00
Modified at S/W Revision	A.02.00, A.03.00

## Couple Markers

When this function is On, moving any marker causes an equal X axis movement of every other marker which is not Off. By “equal X axis movement” we mean that we preserve the difference between each marker’s X axis value (in the fundamental x-axis units of the trace that marker is on) and the X axis value of the marker being moved (in the same fundamental x-axis units).

Key Path	Marker
Mode	SA, WCDMA, C2K, WIMAX OFDMA, TD-SCDMA, 1xEVDO, DVB-T/H, DTMB (CTTB), ISDB-T, CMMB, LTE, LTETDD, Digital Cable TV, MSR, LTEAFDD,LTEATDD
Remote Command	:CALCulate:ACPower:MARKer:COUPle[:STATe] ON OFF 1 0 :CALCulate:ACPower:MARKer:COUPle[:STATe]?
Example	CALC:ACP:MARK:COUP ON
Dependencies	This key is unavailable when "Meas Method" on page 656 is set to RBW.
Preset	OFF
State Saved	Saved in instrument state.
Range	On Off
Initial S/W Revision	Prior to A.02.00
Modified at S/W Revision	A.02.00, A.03.00

## Marker All Off

Turns all active markers off.

Key Path	Marker
Mode	SA, WCDMA, C2K, WIMAX OFDMA, TD-SCDMA, 1xEVDO, DVB-T/H, DTMB (CTTB), ISDB-T, CMMB, LTE, LTETDD, Digital Cable TV, MSR, LTEAFDD,LTEATDD
Remote Command	:CALCulate:ACPower:MARKer:AOFF
Example	CALC:ACP:MARK:AOFF
Dependencies	This key is unavailable when "Meas Method" on page 656 is set to RBW.
Initial S/W Revision	Prior to A.02.00
Modified at S/W Revision	A.02.00, A.03.00

## Marker X Axis Value (Remote Command only)

Sets the marker X axis value in the current marker X Axis Scale unit. This value has no effect if the control mode is Off, but is the SCPI equivalent of entering an X value if the control mode is Normal,Delta or Fixed.

Mode	SA, WCDMA, C2K, WIMAX OFDMA, TD-SCDMA, 1xEVDO, DVB-T/H, DTMB (CTTB), ISDB-T, CMMB, LTE, LTETDD, Digital Cable TV, MSR, LTEAFDD,LTEATDD
Remote Command	:CALCulate:ACPower:MARKer[1] 2 ... 12:X <freq> :CALCulate:ACPower:MARKer[1] 2 ... 12:X?

<b>Example</b>	CALC:ACP:MARK3:X 0 CALC:ACP:MARK3:X?
Notes	The query returns the marker's absolute X Axis value if the control mode is Normal, or the offset from the marker's reference marker if the control mode is Delta. If the marker is Off the response is not a number.
Dependencies	Unavailable when " <b>Meas Method</b> " on page 656 is set to RBW.
Preset	After a preset, all Markers are turned OFF, so Marker X Axis Value query will return a not a number (NAN).
State Saved	No
Min	-9.9E+37
Max	9.9E+37
Initial S/W Revision	Prior to A.02.00
Modified at S/W Revision	A.02.00, A.03.00

### Marker X Axis Position (Remote Command only)

Sets the marker X position in trace points. It has no effect if the control mode is Off, but is the SCPI equivalent of entering a value if the control mode is Normal, Delta or Fixed. The entered value is immediately translated into the current X Axis Scale units for setting the value of the marker.

Mode	SA, WCDMA, C2K, WIMAX OFDMA, TD-SCDMA, 1xEVDO, DVB-T/H, DTMB (CTTB), ISDB-T, CMMB, LTE, LTE-TDD, Digital Cable TV, MSR, LTEAFDD, LTEATDD
<b>Remote Command</b>	:CALCulate:ACPower:MARKer[1] 2 ... 12:X:POSition <real> :CALCulate:ACPower:MARKer[1] 2 ... 12:X:POSition?
<b>Example</b>	CALC:ACP:MARK10:X:POS 0 CALC:ACP:MARK10:X:POS?
Notes	The query returns the marker's absolute X Axis value in trace points if the control mode is Normal, or the offset from the marker's reference marker in trace points if the control mode is Delta. The value is returned as a real number, not an integer, corresponding to the translation from X Axis Scale units to trace points (see "Fractional Trace Points"). If the marker is Off the response is not a number.  When a Marker is turned on, it is placed center of the screen on the trace. Therefore the default value depends on instrument condition, although the Preset/Default is defined as 500 (this value might be expected value when all offset is on).
Dependencies	Unavailable when " <b>Meas Method</b> " on page 656 is set to RBW.
Preset	After a preset, all Markers are turned OFF, so Marker X Axis Value query will return a not a number (NAN).
State Saved	No
Min	-9.9E+37
Max	9.9E+37
Initial S/W Revision	Prior to A.02.00
Modified at S/W Revision	A.02.00, A.03.00

## Marker Y Axis Value (Remote Command only)

Returns the marker Y axis value in the current marker Y axis unit.

Mode	SA, WCDMA, C2K, WIMAX OFDMA, TD-SCDMA, 1xEVDO, DVB-T/H, DTMB (CTTB), ISDB-T, CMMB, LTE, LTEFDD, Digital Cable TV, MSR, LTEAFDD, LTEATDD
<b>Remote Command</b>	:CALCulate:ACPower:MARKer[1] 2 ... 12:Y?
<b>Example</b>	CALC:ACP:MARK11:Y?
Notes	Since the result value is always calculated from acquisition data, the default value is arbitrary. Although the Preset/Default values are defined.
Dependencies	Unavailable when " <b>Meas Method</b> " on page 656 is set to RBW.
Preset	Result dependent on markers setup and signal source.
State Saved	No
<b>Backwards Compatibility SCPI</b>	:CALCulate:ACPower:MARKer[1] 2 ... 12:FUNCTION:RESULT?
Initial S/W Revision	Prior to A.02.00
Modified at S/W Revision	A.02.00, A.03.00

## Backward Compatibility Remote Commands

Sets or queries the state of a marker. Setting a marker which is off to the on state or 1 puts it in Normal mode and places it at the center of the screen.

Mode	SA, WCDMA, WIMAXOFDMA, CDMA2K, TDSCDMA, CDMA1XEV, DVB, DTMB, ISDBT, CMMB, LTE, LTEFDD, DCATV, MSR, LTEAFDD, LTEATDD
<b>Remote Command</b>	:CALCulate:ACPower:MARKer[1] 2 ... 12:STATe OFF ON 0 1 :CALCulate:ACPower:MARKer[1] 2 ... 12:STATe?
<b>Example</b>	CALC:ACP:MARK2:STAT ON CALC:ACP:MARK2:STAT?
Notes	This parameter is also accessed from Marker, Properties, 1 You must be in the mode that includes ACP measurements to use this command. Use :INSTrument:SElect to set the mode.
Preset	OFF OFF OFF OFF OFF OFF OFF OFF OFF OFF OFF OFF
State Saved	Saved in instrument state.
Range	On Off
Initial S/W Revision	Prior to A.02.00
Modified at S/W Revision	A.02.00, A.03.00

## Marker Function

There are no Marker Functions supported in the ACP measurement. The front-panel key will display a blank key menu when pressed.

---

Key Path	Front-panel key
Initial S/W Revision	Prior to A.02.00

---

## Marker To

There is no Marker To functionality supported in ACP. The front-panel key will display a blank key menu when pressed.

---

Key Path	Front-panel key
Initial S/W Revision	Prior to A.02.00

---



## Meas

The information in this section is common to all measurements. For key and remote command information for a specific measurement, refer to the section that describes the measurement of interest.

Measurements available under the Meas key are specific to the current Mode.

When viewing Help for measurements, note the following:

**NOTE**

Operation for some keys differs between measurements. The information displayed in Help pertains to the current measurement. To see how a key operates in a different measurement, exit Help (press the Cancel Esc key), select the measurement, then reenter Help (press the Help key) and press that key.

---

Key Path	Front-panel key
Initial S/W Revision	Prior to A.02.00

---

### Remote Measurement Functions

This section contains the following topics:

"Measurement Group of Commands" on page 1269

"Current Measurement Query (Remote Command Only)" on page 1271

"Limit Test Current Results (Remote Command Only)" on page 1271

"Data Query (Remote Command Only)" on page 1271

"Calculate/Compress Trace Data Query (Remote Command Only)" on page 1272

"Calculate Peaks of Trace Data (Remote Command Only)" on page 1277

"Hardware-Accelerated Fast Power Measurement (Remote Command Only)" on page 1278

"Format Data: Numeric Data (Remote Command Only)" on page 1292

"Format Data: Byte Order (Remote Command Only)" on page 1293

---

Initial S/W Revision	Prior to A.02.00
----------------------	------------------

---

## Measurement Group of Commands

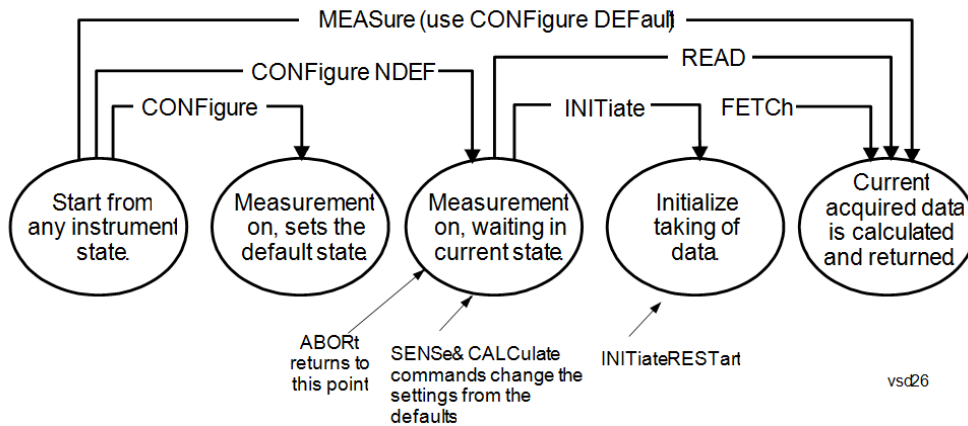

---

### Measure Commands:

`:MEASure:<measurement>[n]?`

This is a fast single-command way to make a measurement using the factory default instrument settings. These are the settings and units that conform to the Mode Setup settings (e.g. radio standard) that you have currently selected.

- Stops the current measurement (if any) and sets up the instrument for the specified measurement using the factory defaults
- Initiates the data acquisition for the measurement
- Blocks other SCPI communication, waiting until the measurement is complete before returning results.
- If the function does averaging, it is turned on and the number of averages is set to 10.
- After the data is valid it returns the scalar results, or the trace data, for the specified measurement. The type of data returned may be defined by an [n] value that is sent with the command.
- The scalar measurement results will be returned if the optional [n] value is not included, or is set to 1. If the [n] value is set to a value other than 1, the selected trace data results will be returned. See each command for details of what types of scalar results or trace data results are available.
- ASCII is the default format for the data output. (Older versions of Spectrum Analysis and Phase Noise mode measurements only use ASCII.) The binary data formats should be used for handling large blocks of data since they are smaller and faster than the ASCII format. Refer to the `FORMat:DATA` command for more information.

If you need to change some of the measurement parameters from the factory default settings you can set up the measurement with the `CONFIGure` command. Use the commands in the `SENSE:<measurement>` and `CALCulate:<measurement>` subsystems to change the settings. Then you can use the `READ?` command to initiate the measurement and query the results.

If you need to repeatedly make a given measurement with settings other than the factory defaults, you can use the commands in the `SENSE:<measurement>` and `CALCulate:<measurement>` subsystems to set up the measurement. Then use the `READ?` command to initiate the measurement and query results.

Measurement settings persist if you initiate a different measurement and then return to a previous one. Use `READ:<measurement>?` if you want to use those persistent settings. If you want to go back to the default settings, use `MEASure:<measurement>?`.

---

### Configure Commands:

`:CONFIGure:<measurement>`

This command stops the current measurement (if any) and sets up the instrument for the specified measurement using

---

---

the factory default instrument settings. It does not initiate the taking of measurement data unless INIT:CONTinuous is ON. If you change any measurement settings after using the CONFigure command, the READ command can be used to initiate a measurement without changing the settings back to their defaults.

In the Swept SA measurement in Spectrum Analyzer mode the CONFigure command also turns the averaging function on and sets the number of averages to 10 for all measurements.

:CONFigure: <measurement>: NDEFault stops the current measurement and changes to the specified measurement. It does not change the settings to the defaults. It does not initiate the taking of measurement data unless INIT:CONTinuous is ON.

The CONFigure? query returns the current measurement name.

The CONFigure:CATalog? query returns a quoted string of all licensed measurement names in the current mode. For example, "SAN, CHP, OBW, ACP, PST, TXP, SPUR, SEM, LIST".

---

#### Fetch Commands:

:FETCh:<measurement>[n]?

This command puts selected data from the most recent measurement into the output buffer. Use FETCh if you have already made a good measurement and you want to return several types of data (different [n] values, for example, both scalars and trace data) from a single measurement. FETCh saves you the time of re-making the measurement. You can only FETCh results from the measurement that is currently active, it will not change to a different measurement. An error message is reported if a measurement other than the current one is specified.

If you need to get new measurement data, use the READ command, which is equivalent to an INITiate followed by a FETCh.

The scalar measurement results will be returned if the optional [n] value is not included, or is set to 1. If the [n] value is set to a value other than 1, the selected trace data results will be returned. See each command for details of what types of scalar results or trace data results are available. The binary data formats should be used for handling large blocks of data since they are smaller and transfer faster than the ASCII format. (FORMat:DATA)

FETCh may be used to return results other than those specified with the original READ or MEASure command that you sent.

---

#### INITiate Commands:

:INITiate:<measurement>

This command is not available for measurements in all the instrument modes:

- Initiates a trigger cycle for the specified measurement, but does not output any data. You must then use the FETCh<meas> command to return data. If a measurement other than the current one is specified, the instrument will switch to that measurement and then initiate it.
- For example, suppose you have previously initiated the ACP measurement, but now you are running the channel power measurement. If you send INIT:ACP? it will change from channel power to ACP and will initiate an ACP measurement.
- Does not change any of the measurement settings. For example, if you have previously started the ACP measurement and you send INIT:ACP? it will initiate a new ACP measurement using the same instrument settings as the last time ACP was run.
- If your selected measurement is currently active (in the idle state) it triggers the measurement, assuming the trigger conditions are met. Then it completes one trigger cycle. Depending upon the measurement and the number of averages, there may be multiple data acquisitions, with multiple trigger events, for one full trigger cycle. It also holds off additional commands on GPIB until the acquisition is complete.

---

#### READ Commands:

:READ:<measurement>[n]?

- Does not preset the measurement to the factory default settings. For example, if you have previously initiated the ACP
-

---

measurement and you send READ:ACP? it will initiate a new measurement using the same instrument settings.

- Initiates the measurement and puts valid data into the output buffer. If a measurement other than the current one is specified, the instrument will switch to that measurement before it initiates the measurement and returns results.
  - For example, suppose you have previously initiated the ACP measurement, but now you are running the channel power measurement. Then you send READ:ACP? It will change from channel power back to ACP and, using the previous ACP settings, will initiate the measurement and return results.
  - Blocks other SCPI communication, waiting until the measurement is complete before returning the results
  - If the optional [n] value is not included, or is set to 1, the scalar measurement results will be returned. If the [n] value is set to a value other than 1, the selected trace data results will be returned. See each command for details of what types of scalar results or trace data results are available. The binary data formats should be used when handling large blocks of data since they are smaller and faster than the ASCII format. (FORMat:DATA)
- 

---

Initial S/W Revision	Prior to A.02.00
----------------------	------------------

---

### Current Measurement Query (Remote Command Only)

This command returns the name of the measurement that is currently running.

---

<b>Remote Command</b>	:CONFigure?
-----------------------	-------------

---

<b>Example</b>	CONF?
----------------	-------

---

Initial S/W Revision	Prior to A.02.00
----------------------	------------------

---

### Limit Test Current Results (Remote Command Only)

Queries the status of the current measurement limit testing. It returns a 0 if the measured results pass when compared with the current limits. It returns a 1 if the measured results fail any limit tests.

---

<b>Remote Command</b>	:CALCulate:CLIMits:FAIL?
-----------------------	--------------------------

---

<b>Example</b>	CALC:CLIM:FAIL? queries the current measurement to see if it fails the defined limits. Returns a 0 or 1: 0 it passes, 1 it fails.
----------------	--------------------------------------------------------------------------------------------------------------------------------------

---

Initial S/W Revision	Prior to A.02.00
----------------------	------------------

---

### Data Query (Remote Command Only)

Returns the designated measurement data for the currently selected measurement and subopcode.

n = any valid subopcode for the current measurement. See the measurement command results table for your current measurement, for information about what data is returned for the subopcodes.

This command uses the data setting specified by the FORMat:BORDER and FORMat:DATA commands and can return real or ASCII data. (See the format command descriptions under Input/Output in the Analyzer Setup section.)

<b>Remote Command</b>	:CALCulate:DATA[n]?
<b>Notes</b>	The return trace depends on the measurement. In CALCulate:<meas>:DATA[n], n is any valid subopcode for the current measurement. It returns the same data as the FETCH:<measurement>? query where <measurement> is the current measurement.
<b>Initial S/W Revision</b>	Prior to A.02.00

## Calculate/Compress Trace Data Query (Remote Command Only)

Returns compressed data for the currently selected measurement and sub-opcode [n].

n = any valid sub-opcode for that measurement. See the MEASure:<measurement>? command description of your specific measurement for information on the data that can be returned.

The data is returned in the current Y Axis Unit of the analyzer. The command is used with a sub-opcode <n> (default=1) to specify the trace. With trace queries, it is best if the analyzer is not sweeping during the query. Therefore, it is generally advisable to be in Single Sweep, or Update=Off.

This command is used to compress or decimate a long trace to extract and return only the desired data. A typical example would be to acquire N frames of GSM data and return the mean power of the first burst in each frame. The command can also be used to identify the best curve fit for the data.

<b>Remote Command</b>	:CALCulate:DATA<n>:COMPRESS? BLOCK   CFIT   MAXimum   MINimum   MEAN   DMEan   RMS   RMSCubed   SAMPLE   SDEVIation   PPHase [,<soffset> [,<length>[,<roffset>[,<rlimit>]]]]
<b>Example</b>	To query the mean power of a set of GSM bursts: Supply a signal that is a set of GSM bursts. Select the IQ Waveform measurement (in IQ Analyzer Mode). Set the sweep time to acquire at least one burst. Set the triggers such that acquisition happens at a known position relative to a burst. Then query the mean burst levels using, CALC:DATA2:COMP? MEAN, 24e-6, 526e-6 (These parameter values correspond to GSM signals, where 526e-6 is the length of the burst in the slot and you just want 1 burst.)
<b>Notes</b>	The command supports 5 parameters. Note that the last 4 (<soffset>, <length>, <roffset>, <rlimit>) are optional. But these optional parameters must be entered in the specified order. For example, if you want to specify <length>, then you must also specify <soffset>. See details below for a definition of each of these parameters.  This command uses the data in the format specified by FORMat:DATA, returning either binary or ASCII data.
<b>Initial S/W Revision</b>	Prior to A.02.00

- BLOCK or block data - returns all the data points from the region of the trace data that you specify. For example, it could be used to return the data points of an input signal over several timeslots, excluding the portions of the trace data that you do not want. (This is x,y pairs for trace data and I,Q pairs for complex data.)

- CFIT or curve fit - applies curve fitting routines to the data. <soffset> and <length> are required to define the data that you want. <roffset> is an optional parameter for the desired order of the curve equation. The query will return the following values: the x-offset (in seconds) and the curve coefficients ((order + 1) values).

MIN, MAX, MEAN, DME, RMS, RMSC, SAMP, SDEV and PPH return one data value for each specified region (or <length>) of trace data, for as many regions as possible until you run out of trace data (using <roffset> to specify regions). Or they return the number of regions you specify (using <rlimit>) ignoring any data beyond that.

- MINimum - returns the minimum data point (y value) for the specified region(s) of trace data. For I/Q trace data, the minimum magnitude of the I/Q pairs is returned.
- MAXimum - returns the maximum data point (y value) for the specified region(s) of trace data. For I/Q trace data, the maximum magnitude of the I/Q pairs is returned.
- MEAN - returns a single value that is the arithmetic mean of the data point values (in dB/ dBm) for the specified region(s) of trace data. For I/Q trace data, the mean of the magnitudes of the I/Q pairs is returned. See the following equations.

**NOTE** If the original trace data is in dB, this function returns the arithmetic mean of those log values, not log of the mean power which is a more useful value. The mean of the log is the better measurement technique when measuring CW signals in the presence of noise. The mean of the power, expressed in dB, is useful in power measurements such as Channel Power. To achieve the mean of the power, use the RMS option.

Equation 1

Mean Value of Data Points for Specified Region(s)

$$MEAN = \frac{1}{n} \sum_{X_i \in \text{region}(s)} X_i$$

where  $X_i$  is a data point value, and  $n$  is the number of data points in the specified region(s).

Equation 2

Mean Value of I/Q Data Pairs for Specified Region(s)

$$MEAN = \frac{1}{n} \sum_{X_i \in \text{region}(s)} |X_i|$$

where  $|X_i|$  is the magnitude of an I/Q pair, and  $n$  is the number of I/Q pairs in the specified region(s).

- DMEan - returns a single value that is the mean power (in dB/ dBm) of the data point values for the specified region(s) of trace data. See the following equation:

Equation 3

DMEan Value of Data Points for Specified Region(s)

$$\text{DME} = 10 \times \log_{10} \left( \frac{1}{n} \sum_{X_i \in \text{region}(s)} 10^{\frac{X_i}{10}} \right)$$

- RMS - returns a single value that is the average power on a root-mean-squared voltage scale (arithmetic rms) of the data point values for the specified region(s) of trace data. See the following equation.

**NOTE** For I/Q trace data, the rms of the magnitudes of the I/Q pairs is returned. See the following equation. This function is very useful for I/Q trace data. However, if the original trace data is in dB, this function returns the rms of the log values which is not usually needed.

Equation 4

RMS Value of Data Points for Specified Region(s)

$$\text{RMS} = \sqrt{\frac{1}{n} \sum_{X_i \in \text{region}(s)} X_i^2}$$

where  $X_i$  is a data point value, and  $n$  is the number of data points in the specified region(s).

Equation 5

RMS Value of I/Q Data Pairs for Specified Region(s)

$$\text{RMS} = \sqrt{\frac{1}{n} \sum_{X_i \in \text{region}(s)} X_i X_i^*}$$

where  $X_i$  is the complex value representation of an I/Q pair,  $X_i^*$  its conjugate complex number, and  $n$  is the number of I/Q pairs in the specified region(s).

Once you have the rms value for a region of trace data (linear or I/Q), you may want to calculate the mean power. You must convert this rms value (peak volts) to power in dBm:

$$10 \times \log[10 \times (\text{rms value})^2]$$

- SAMPlE - returns the first data value (x,y pair) for the specified region(s) of trace data. For I/Q trace data, the first I/Q pair is returned.
- SDEVIation - returns a single value that is the arithmetic standard deviation for the data point values for the specified region(s) of trace data. See the following equation.
- For I/Q trace data, the standard deviation of the magnitudes of the I/Q pairs is returned. See the following equation.

Equation 6

Standard Deviation of Data Point Values for Specified Region(s)

$$\text{SDEV} = \sqrt{\frac{1}{n} \sum_{X_i \in \text{region}(s)} (X_i - \bar{X})^2}$$

where  $X_i$  is a data point value,  $\bar{X}$  is the arithmetic mean of the data point values for the specified region (s), and  $n$  is the number of data points in the specified region(s).

$$\text{SDEV} = \sqrt{\frac{1}{n} \sum_{X_i \in \text{region}(s)} (|X_i| - \bar{X})^2}$$

where  $|X_i|$  is the magnitude of an I/Q pair,  $\bar{X}$  is the mean of the magnitudes for the specified region(s), and  $n$  is the number of data points in the specified region(s).

- PPHase - returns the x,y pairs of both rms power (dBm) and arithmetic mean phase (radian) for every specified region and frequency offset (Hz). The number of pairs is defined by the specified number of regions. This parameter can be used for I/Q vector ( $n=0$ ) in Waveform (time domain) measurement and all parameters are specified by data point in PPHase.

The rms power of the specified region may be expressed as:

$$\text{Power} = 10 \times \log [10 \times (\text{RMS I/Q value})] + 10.$$

The RMS I/Q value (peak volts) is:

$$\sqrt{\frac{1}{n} \sum_{X_i \in \text{region}} X_i X_i^*}$$

where  $X_i$  is the complex value representation of an I/Q pair,  $X_i^*$  its conjugate complex number, and  $n$  is the number of I/Q pairs in the specified region.

The arithmetic mean phase of the specified region may be expressed as:

$$\frac{1}{n} \sum_{Y_i \in \text{region}} Y_i$$

where  $Y_i$  is the unwrapped phase of I/Q pair with applying frequency correction and  $n$  is the number of I/Q pairs in the specified region.

The frequency correction is made by the frequency offset calculated by the arithmetic mean of every specified region's frequency offset. Each frequency offset is calculated by the least square method against the unwrapped phase of I/Q pair.

Sample Trace Data - Constant Envelope

(See below for explanation of variables.)



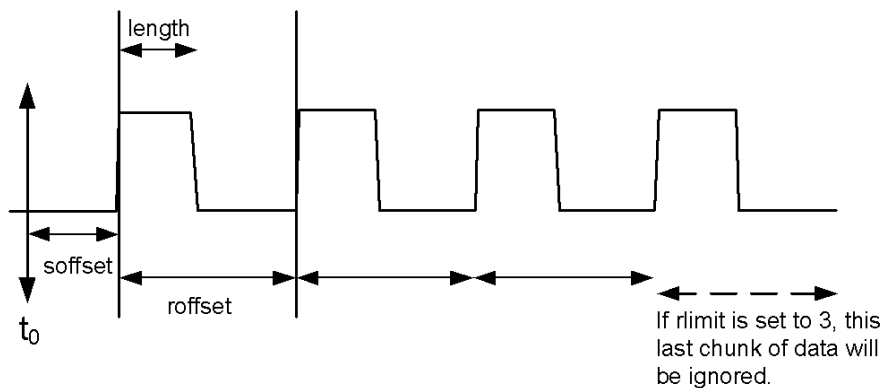

### Sample Trace Data - Not Constant Envelope

(See below for explanation of variables.)

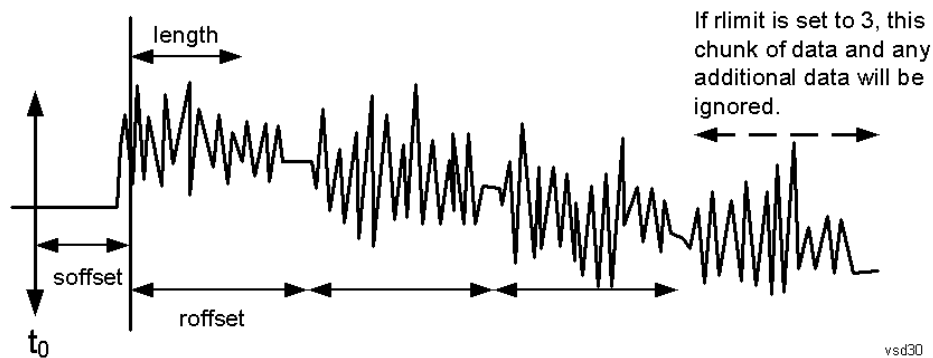

<soffset> - start offset is an optional real number. (It is in seconds for time-domain traces, and is a dimensionless index 0 to Npoints - 1, for frequency-domain traces). It specifies the amount of data at the beginning of the trace that will be ignored before the decimation process starts. It is the time or frequency change from the start of the trace to the point where you want to start using the data. The default value is zero.

<length> - is an optional real number. (It is in seconds for time-domain traces, and is a dimensionless index 0 to Npoints - 1, for frequency-domain traces). It defines how much data will be compressed into one value. This parameter has a default value equal to the current trace length.

<roffset> - repeat offset is an optional real number. (It is in seconds for time-domain traces, and is a dimensionless index 0 to Npoints - 1, for frequency-domain traces). It defines the beginning of the next field of trace elements to be compressed. This is relative to the beginning of the previous field. This parameter has a default value equal to the <length> variable. Note that this parameter is used for a completely different purpose when curve fitting (see CFIT above).

<rlimit> - repeat limit is an optional integer. It specifies the number of data items that you want returned. It will ignore any additional items beyond that number. You can use the Start offset and the Repeat limit to pick out exactly what part of the data you want to use. The default value is all the data.

## Calculate Peaks of Trace Data (Remote Command Only)

Returns a list of all the peaks for the currently selected measurement and sub-opcode [n]. The peaks must meet the requirements of the peak threshold and excursion values.

n = any valid sub-opcode for the current measurement. See the MEASure:<measurement> command description of your specific measurement for information on the data that can be returned.

The command can only be used with specific sub-opcodes with measurement results that are trace data. Both real and complex traces can be searched, but complex traces are converted to magnitude in dBm. In many measurements the sub-opcode n=0, is the raw trace data which cannot be searched for peaks. And Sub-opcode n=1, is often calculated results values which also cannot be searched for peaks.

This command uses the data setting specified by the FORMat:BORDER and FORMat:DATA commands and can return real or ASCII data. If the format is set to INT,32, it returns REAL,32 data.

The command has four types of parameters:

- Threshold (in dBm)
- Excursion (in dB)
- Sorting order (amplitude, frequency, time)
- Optional in some measurements: Display line use (all, > display line, < display line)

---

<b>Remote Command</b>	<p>For Swept SA measurement:</p> <pre>:CALCulate:DATA[1] 2 ... 6:PEAKs? &lt;threshold&gt;,&lt;excursion&gt;[,AMPLitude   FREQuency   TIME[,ALL   GTDLine   LTDLine]]</pre> <p>For most other measurements:</p> <pre>:CALCulate:DATA[1] 2 ... 6:PEAKs? &lt;threshold&gt;,&lt;excursion&gt;[,AMPLitude   FREQuency   TIME]</pre>
-----------------------	--------------------------------------------------------------------------------------------------------------------------------------------------------------------------------------------------------------------------------------------------------------------------------------------------------------------------------

---

<b>Example</b>	<p>Example for Swept SA measurement in Spectrum Analyzer Mode:</p> <p>CALC:DATA4:PEAK? -40, 10, FREQ, GTDL This will identify the peaks of trace 4 that are above -40 dBm, with excursions of at least 10 dB. The peaks are returned in order of increasing frequency, starting with the lowest frequency. Only the peaks that are above the display line are returned.</p> <p>Query Results 1:</p> <p>With FORMat:DATA REAL, 32 selected, it returns a list of floating-point numbers. The first value in the list is the number of peak points that are in the following list. A peak point consists of two values: a peak amplitude followed by its corresponding frequency (or time).</p> <p>If no peaks are found the peak list will consist of only the number of peaks, (0).</p>
----------------	-----------------------------------------------------------------------------------------------------------------------------------------------------------------------------------------------------------------------------------------------------------------------------------------------------------------------------------------------------------------------------------------------------------------------------------------------------------------------------------------------------------------------------------------------------------------------------------------------------------------------------------------------------------------------------------------------------------------------------------------------------------------------------------------

---

<b>Notes</b>	<p>&lt;n&gt; - is the trace that will be used</p> <p>&lt;threshold&gt; - is the level below which trace data peaks are ignored. Note that the threshold value is required and is always used as a peak criterion. To effectively disable the threshold criterion for this command, provide a substantially low threshold value such as -200 dBm. Also note that the threshold value used in this command is independent of and has no effect on the threshold value stored under the Peak Criteria menu.</p> <p>&lt;excursion&gt; - is the minimum amplitude variation (rise and fall) required for a signal to be identified as peak. Note that the excursion value is required and is always used as a peak criterion. To effectively disable the excursion criterion for this command, provide the minimum value of 0.0 dB. Also note that the excursion value used in this command is independent of and has no effect on the</p>
--------------	---------------------------------------------------------------------------------------------------------------------------------------------------------------------------------------------------------------------------------------------------------------------------------------------------------------------------------------------------------------------------------------------------------------------------------------------------------------------------------------------------------------------------------------------------------------------------------------------------------------------------------------------------------------------------------------------------------------------------------------------------------------------------------------------------------------------------------------------------------------------------------------------------------------------------------------

---

---

excursion value stored under the Peak Criteria menu.

Values must be provided for threshold and excursion. The sorting and display line parameters are optional (defaults are AMPLitude and ALL).

Note that there is always a Y-axis value for the display line, regardless of whether the display line state is on or off. It is the current Y-axis value of the display line which is used by this command to determine whether a peak should be reported. Sorting order:

AMPLitude - lists the peaks in order of descending amplitude, with the highest peak first (default if optional parameter not sent)

FREQUENCY - lists the peaks in order of occurrence, left to right across the x-axis.

TIME - lists the peaks in order of occurrence, left to right across the x-axis.

Peaks vs. Display Line:

ALL - lists all of the peaks found (default if optional parameter not sent).

GTDLine (greater than display line) - lists all of the peaks found above the display line.

LTDLine (less than display line) - lists all of the peaks found below the display line.

---

Initial S/W Revision	Prior to A.02.00
----------------------	------------------

---

## Hardware-Accelerated Fast Power Measurement (Remote Command Only)

The Fast Power option (FP2) enables very fast channel power measurements for instruments with the prerequisite hardware (DP2 and/or B40). It accomplishes this by performing real-time overlapped FFTs at the hardware layer, using software for basic post-processing before returning the result to the user. The upshot of this approach is improved throughput for user applications that require many sequential power measurements.

The analysis bandwidth of FP2 is limited by the licenses in the instrument, but its maximum overall analysis bandwidth per acquisition is 40 MHz.

FP2 is remote-only, which means the instrument does not switch to any particular mode or measurement. FP2 commands can be sent while another application is in use on the front panel.

Each Fast Power measurement can be predefined using an array index, and up to 1,000 measurements can be stored. In the following documentation, instances of [1,2,...,999] can be substituted with a particular measurement index, e.g. CALC:FPOW:POW1?, CALC:FPOW:POW2?, CALC:FPOW:POW134?. In this way, power measurements can be defined one time in a batch, and then executed multiple times without having to redefine them, similar to “list mode” on other measurements.

In addition to basic channel power measurements, there are a number of other measurement “functions” for each channel, including peak power, peak frequency, and power spectral density. See the Function parameter for more information.

## Reset Fast Power Measurement (Remote Command Only)

Resets the measurement configuration to the defaults.

---

Mode	All
Remote Command	:CALCulate:FPOWer:POWer[1,2,...,999]:RESet
Example	:CALC:FPOW:POW1:RES

---

Notes	Option FP2 is required.
Initial S/W Revision	A.14.00

### Define Fast Power Measurement (Remote Command Only)

Fast Power acquisitions are configured using the DEFine command. This command accepts a comma-delimited string of configuration parameters and their appropriate values, which are all specified in the subsection below.

Mode	All
<b>Remote Command</b>	:CALCulate:FPOWER:POWer[1,2,...,999]:DEFine "configuration string"
<b>Example</b>	:CALC:FPOW:POW1:DEF "CenterFrequency=2e9, AcquisitionTime=0.005"
Notes	See below for a list of measurement variables that can be defined in the configuration string.
Initial S/W Revision	A.14.00

### Acquisition Time

Example	CALC:FPOW:POW1:DEF "AcquisitionTime=0.002"
Notes	The acquisition time parameter sets the time in which the entire spectrum is measured. An increase in the acquisition time yields an improvement in measurement repeatability.
Preset	0.001 s
Range	0 s to 1 s
Default Unit	Time (s)
Initial S/W Revision	A.14.00

### Center Frequency

Example	CALC:FPOW:POW1:DEF "CenterFrequency=2e9"
Notes	The center frequency parameter sets the frequency in which the measurement is centered around. The OffsetFrequency parameter is calculated relative to the center frequency.
Preset	1 GHz
Range	0 Hz to maximum instrument frequency
Default Unit	Frequency (Hz)
Initial S/W Revision	A.14.00

## DC Coupled

Example	CALC:FPOW:POW1:DEF "DCCoupled=True"
Notes	The DC coupled parameter allows the user to specify whether the DC blocking capacitor is utilized. Set parameter to true when measuring frequencies below 10 MHz.
Preset	False
Range	True (DC Coupled) or False (AC Coupled)
Default Unit	Boolean
Initial S/W Revision	A.14.00

## DetectorType

Example	CALC:FPOW:POW1:DEF "DetectorType=Peak"
Notes	Option FP2 is required. The detector type parameter allows the user to choose whether a RMS average or peak value is used during the measurement.
Preset	RmsAverage
Range	RmsAverage, Peak
Initial S/W Revision	A.14.00

## Do Noise Correction

Example	CALC:FPOW:POW1:DEF "DoNoiseCorrection=True"
Notes	When noise correction is enabled, the linear noise power contributed by the analyzer is subtracted from all measurements. This effectively lowers the noise floor of the analyzer. When noise correction is enabled, the first measurement for a given set of input parameters will take extra time. This is because the analyzer takes an extra acquisition with the RF input disconnected from the analyzer's front end to measure the noise of just the analyzer. The measured noise floor is stored in a cache so the noise acquisition will occur only once for the same state settings. In other words, if noise correction was turned on and the analyzer made an acquisition at frequency A, then frequency B, and back again to frequency A, the hidden initial noise floor acquisition would only occur for the first acquisition at frequency A and the cached noise floor would be used the second time frequency A was measured.
Preset	False
Range	True (enable noise correction) or False (disable noise correction)
Default Unit	Boolean
Initial S/W Revision	A.14.00

### Do Spur Suppression

Example	CALC:FPOW:POW1:DEF "DoSpurSuppression=True"
Notes	<p>When measuring very low level signals, or when large out-of-band inputs are input into the analyzer, sometimes unwanted spurs and residuals can appear in the measured spectrum. Spur suppression is a method to help minimize the levels of these internally generated spurs and residuals.</p> <p>When spur suppression is enabled, the analyzer will automatically take two acquisitions using two different internal analog LO frequencies. The FFT spectrums from both acquisitions are combined by taking the minimum power between both traces on a per FFT bin basis. External signals will have the same amplitude for both traces and therefore will return the expected amplitudes. However, low level spurs and residuals generated internally to the analyzer tend to move to different FFT bins depending on the internal analog LO frequency used, and therefore tend to be suppressed using this spur suppression method.</p> <p>Because two acquisitions, rather than a single acquisition, are made when spur suppression is enabled, the measurement time will always be slower when spur suppression is enabled.</p>
Preset	False
Range	True (enable spur suppression) or False (disable spur suppression)
Default Unit	Boolean
Initial S/W Revision	A.14.00

### Electronic Attenuator Bypass

Example	CALC:FPOW:POW1:DEF "ElecAttBypass =False"
Notes	The electronic attenuation bypass parameter allows the user to either utilize or bypass the electronic attenuator. The electronic attenuator is only available for frequencies up to 3.6 GHz. Set parameter to true when using frequencies above 3.6 GHz and set the parameter to false when using the preamp.
Preset	True
Range	True (bypass electronic attenuator) or False (use electronic attenuator)
Default Unit	Boolean
Initial S/W Revision	A.14.00

### Electronic Attenuation

Example	CALC:FPOW:POW1:DEF "ElecAttenuation=10"
Notes	<p>Option EA3 is required.</p> <p>The electronic attenuation value parameter sets the amount of electrical attenuation from 0 to 24 dB (1 dB steps).</p> <p>Set "ElecAttBypass=False" to make sure the electronic attenuator path is enabled.</p>
Preset	0 dB
Range	0 – 24 dB (1 dB steps)

Default Unit	dB
Initial S/W Revision	A.14.00

### IF Gain

Example	CALC:FPOW:POW1:DEF "IFGain=10"
Notes	The IF gain parameter allows the user to specify the gain at the IF stage anywhere from -6 to 16 dB (1 dB steps). This is an advanced feature, and for most cases this should remain at its default value of 0 dB.
Preset	0 dB
Range	-6 - 16 dB (1 dB steps)
Default Unit	dB
Initial S/W Revision	A.14.00

### IF Type

Example	CALC:FPOW:POW1:DEF "IFType=B25M"
Notes	The IF type parameter allows the user to select between different IF paths. For example, if the signal is less than 25 MHz wide, then the user can select the B25M path to take advantage of additional filtering on this analog IF path.
Preset	B40M
Range	B10M, B25M, B40M
Initial S/W Revision	A.14.00

### Include Power Spectrum

Example	CALC:FPOW:POW1:DEF "IncludePowerSpectrum=True"
Notes	The power spectrum parameter allows the user to read data on the entire spectrum for diagnostic purposes. It is not recommended for production use. See CALC:FPOW:POW[n]:READ2? for details on the binary format of the response.
Preset	False
Range	True (return both channel power and full power spectrum) or False (returns only channel power)
Default Unit	Boolean
Initial S/W Revision	A.14.00

### Mechanical Attenuation

Example	CALC:FPOW:POW1:DEF "MechAttenuation=10"
Notes	The mechanical attenuation value parameter sets the amount of mechanical attenuation anywhere from 0 to 70 dB (2 dB steps).
Preset	0 dB
Range	0 – 70 dB (2 dB steps)
Default Unit	dB
Initial S/W Revision	A.14.00

### Preamp Mode

Example	CALC:FPOW:POW1:DEF "PreAmpMode=Low"
Notes	The license for the appropriate preamp is required. The preamp mode parameter specifies whether the preamps are being utilized. Low allows any preamps up to 3.6 GHz, and Full allows all licensed preamps. Set "ElecAttBypass=True" in order to utilize any preamps.
Preset	Off
Range	Off, Low, Full
Initial S/W Revision	A.14.00

### Resolution Bandwidth Mode

Example	CALC:FPOW:POW1:DEF "PreAmpMode=Low"
Notes	The resolution bandwidth mode parameter allows the user to choose whether the RBW filter is automatically or manually set. The BestSpeed value minimizes measurement time, while the Narrowest value minimizes RBW size (minimum of two FFT bins per RBW). To manually specify an RBW, set this parameter to Explicit, and set the ResolutionBW parameter to the desired value.
Preset	BestSpeed
Range	BestSpeed, Narrowest, Explicit
Initial S/W Revision	A.14.00

### Resolution Bandwidth

Example	CALC:FPOW:POW1:DEF "ResolutionBW=25e3"
Notes	The resolution bandwidth parameter sets the 3-dB bandwidth of the RBW filter. The ResolutionBWMode parameter must be set to Explicit in order to manually set the RBW.



Preset	0 Hz
Default Unit	Hz
Initial S/W Revision	A.14.00

#### Trigger Delay

Example	CALC:FPOW:POW1:DEF "TriggerDelay=0.025"
Notes	The trigger delay parameter sets the time after an external trigger is detected until the measurement is performed.
Preset	0 s
Range	0 – 1 s
Default Unit	Seconds
Initial S/W Revision	A.14.00

#### Trigger Level

Example	CALC:FPOW:POW1:DEF "TriggerLevel=2"
Notes	The trigger level parameter sets the voltage value at which an external trigger is detected.
Preset	1.2 V
Range	-5 to 5 V
Default Unit	Volts
Initial S/W Revision	A.14.00

#### Trigger Slope

Example	CALC:FPOW:POW1:DEF "TriggerSlope=Negative"
Notes	The trigger slope parameter indicates the direction of the edge trigger voltage for detection.
Preset	Positive
Range	Positive, Negative
Initial S/W Revision	A.14.00

### Trigger Source

Example	CALC:FPOW:POW1:DEF "TriggerSource=Ext1"
Notes	The trigger source parameter allows the user to choose between measurement's triggering freely or controlled by an external input. Ext1 and Ext2 correspond to Trigger 1 In and Trigger 2 In, respectively.
Preset	Free
Range	Free, Ext1, Ext2
Initial S/W Revision	A.14.00

### Trigger Timeout

Example	CALC:FPOW:POW1:DEF "TriggerTimeout=0.1"
Notes	The trigger timeout parameter sets the time in which the analyzer will wait for a trigger before automatically performing the measurement.
Preset	1 s
Range	0 - 1 s
Default Unit	Seconds
Initial S/W Revision	A.14.00

### Signal Input

Example	CALC:FPOW:POW1:DEF "SignalInput=Fp50MHzCW"
Notes	The signal input parameter allows the user to select between using the main RF input or the internal analyzer reference CW signal of 50 MHz.
Preset	FpMainRf
Range	FpMainRf, Fp50MHzCW
Initial S/W Revision	A.14.00

### Use Preselector

Example	CALC:FPOW:POW1:DEF "UsePreSelector=True"
Notes	The preselector parameter allows the user to either utilize or bypass the front end tunable filter at frequencies above 3.6 GHz. For frequencies below 3.6 GHz, the preselector is automatically bypassed, so you do not need to set this parameter to False in those cases.
Preset	False
Range	True (use preselector above 3.6 GHz), or False (preselector bypassed)

Default Unit	Boolean
Initial S/W Revision	A.14.00

### Channel Bandwidth Array

Example	CALC:FPOW:POW1:DEF "Bandwidth=[3.84e6, 5e6, 3.84e6]"
Notes	The bandwidth parameter array defines the bandwidth of each channel that will be measured. All array parameters should have the same number of elements. Alternatively, if all the elements are the same value, a single number with no square brackets can be used to define the parameter.
Preset	[1 e6]
Range	0 to 40 MHz
Default Unit	Hz
Initial S/W Revision	A.14.00

### Channel Filter Type Array

Example	CALC:FPOW:POW1:DEF "FilterType=[RRC, IBW, RRC]"
Notes	The filter type parameter allows the user to choose between an integration bandwidth (IBW) filter or a root-raised-cosine (RRC) filter. The integration bandwidth filter weighs all frequencies within the bandwidth equally. The root-raised-cosine filter has an associated shape parameter, defined by the FilterAlpha parameter. All array parameters should have the same number of elements. Alternatively, if all the elements are the same value, a single value with no square brackets can be used to define the parameter.
Preset	[IBW]
Range	IBW, RRC
Initial S/W Revision	A.14.00

### Channel Filter Alpha Array

Example	CALC:FPOW:POW1:DEF "FilterAlpha=[0.5, 0.0, 0.5]"
Notes	The filter alpha parameter allows the user to adjust the alpha value associated with the root-raised-cosine (RRC) filter type. Set FilterType to RRC in order to utilize this parameter. All array parameters should have the same number of elements. Alternatively, if all the elements are the same value, a single number with no square brackets can be used to define the parameter.
Preset	[0.22]
Range	0.0 - 1.0

Initial S/W Revision	A.14.00
-------------------------	---------

### Channel Measurement Function Array

Example	CALC:FPOW:POW1:DEF "Function=[BandPower, PeakPower, BandPower]"
Notes	<p>This parameter array defines what measurement is being made for each individually-specified channel:</p> <p>BandPower: Total power within the specified bandwidth of the channel (dBm)</p> <p>BandDensity: Total power density within the specified bandwidth of the channel (dBm/Hz)</p> <p>PeakPower: The peak power value within the specified bandwidth of the channel (dBm)</p> <p>PeakFrequency: The frequency which corresponds to the peak power value within the specified bandwidth of the channel. This frequency is relative to the center frequency (Hz)</p> <p>XdBBandwidth: The half power (-3.01 dB) bandwidth of the highest amplitude signal that resides within the channel (Hz), dB is configurable using XdBBandwidth parameter</p> <p>OccupiedBandwidth: The bandwidth at which 99% of the total power resides within the channel (Hz), percentage configurable using OccupiedBandwidthPercent parameter</p> <p>All array parameters should have the same number of elements. Alternatively, if all the elements are the same value, a single value with no square brackets can be used to define the parameter.</p>
Preset	[BandPower]
Range	BandPower, BandDensity, PeakPower, PeakFrequency, XdBBandwidth, OccupiedBandwidth
Initial S/W Revision	A.14.00

### Channel Offset Frequency Array

Example	CALC:FPOW:POW1:DEF "OffsetFrequency=[-5e6, 0, 5e6]"
Notes	<p>The offset frequency parameter array defines the difference between the center frequency to the center frequency of each channel.</p> <p>All array parameters should have the same number of elements.</p>
Preset	[0]
Range	0 to 20 MHz
Default Unit	Hz
Initial S/W Revision	A.14.00

### Channel Occupied Bandwidth Percent Array

Example	CALC:FPOW:POW1:DEF "OccupiedBandwidthPercent =[0.95, 0.95, 0.95]"
Notes	This parameter only applies for channels whose Function is set to OccupiedBandwidth. The occupied

---

bandwidth percent parameter specifies the percent of total power in these channels. The valid range for this parameter is 0.0 to 1.0, where 1.0 represents 100%. The default for this parameter is 0.99, which will return the bandwidth that contains 99% of the total channel power.

---

Preset	[0.99]
Range	0 – 1.0
Initial S/W Revision	A.14.00

---

### Channel x-dB Bandwidth Array

---

Example	CALC:FPOW:POW1:DEF " XdBBandwidth =[-6.02, -3.01, -1.0]"
Notes	This parameter only applies for channels whose Function is set to XdBBandwidth. The X dB bandwidth parameter is used to specify the power relative to the peak channel power over which the bandwidth is calculated. The parameter value must be a negative number.
Preset	[-3.01]
Range	-200 to 0 dB
Default Unit	dB
Initial S/W Revision	A.14.00

---

### Define Fast Power Measurement Query (Remote Command Only)

The DEFine? command is used to retrieve a list of all defined parameters in an ASCII string format

---

```

M All
o
d
e
R :CALCulate:FPOWER:POWer [1,2,...,999]:DEFine?
e
m
o
t
e
C
o
m
m
a
n
d
E :CALC:FPOW:POW1:DEF?

```

---

---

x  
a  
m  
p  
l  
e

---

N This command query is used to retrieve a list of all defined parameters in an ASCII format.  
o The following is an example of the returned results:  
t "DCCoupled=False,ElecAttBypass=True,ElecAttenuation=0,IFGain=0,MechAttenuation=0,PreAmpMode=Off,PreSelectorOffset  
e =0,UsePreSelector=False,ExternalReferenceFrequency=10000000,FrequencyReferenceSource=AutoExternalFrequencyRefer  
s ence,IFType=B40M,LOMode=SLW,SignalInput=FpMainRf,AcquisitionTime=0.001,CenterFrequency=1000000000,Resolution  
BW=0,ResolutionBWMode=BestSpeed,DetectorType=RmsAverage,Bandwidth=[1000000],OffsetFrequency=[0],Function=  
[BandPower],FilterType=[IBW],FilterAlpha=[0.22],OccupiedBandwidthPercent=[0.99],XdBBandwidth=[-  
3.01],DoNoiseCorrection=False,DoSpurSuppression=False,MeasurementMethod=HardwareFFT,IncludePowerSpectrum=False,  
e,TriggerDelay=0,TriggerLevel=1.2,TriggerSlope=Positive,TriggerSource=Free,TriggerTimeout=1 "

---

I A.14.00  
n  
i  
t  
i  
a  
l

S  
/  
W

R  
e  
v  
i  
s  
i  
o  
n

---

### Configure Fast Power Measurement (Remote Command Only)

The configure command begins hardware setup and returns immediately, with no acquisition made. This can be used in parallel with other hardware operations to effectively hide the hardware setup time.

Mode	All
<b>Remote Command</b>	:CALCulate:FPOWer:POWer[1,2,...,999]:CONFigure
<b>Example</b>	:CALC:FPOW:POW1:CONF
Notes	Option FP2 is required.
Initial S/W Revision	A.14.00

### Initiate Fast Power Measurement (Remote Command Only)

The INITiate command begins an acquisition and returns immediately. The results of the measurement can be retrieved using FETCh.

Mode	All
<b>Remote Command</b>	:CALCulate:FPOWer:POWer[1,2,...,999]:INITiate
<b>Example</b>	:CALC:FPOW:POW1:INIT
Notes	Option FP2 is required.
Initial S/W Revision	A.14.00

### Fetch Fast Power Measurement (Remote Command Only)

The FETCh command query is used to retrieve the results of an acquisition initiated by the INIT command. The returned results are in ASCII string format. The string begins and ends with quotation marks.

Mode	All
<b>Remote Command</b>	:CALCulate:FPOWer:POWer[1,2,...,999]:FETCh?
<b>Example</b>	:CALC:FPOW:POW1:FETC?
Notes	Option FP2 is required. Returns m comma-separated ASCII values, where m corresponds to the number of bandwidths defined. 1. Declared function return in the 1st specified channel 2. Declared function return in the 2nd specified channel ... m. Declared function return in the last specified channel The INIT and FETC? command sequence performs the same functionality of a single CALC:FPOW:POW[n]? query. Units of the returned values are dependent on the Function parameter for each channel.
Initial S/W Revision	A.14.00

### Execute Fast Power Measurement (Remote Command Only)

This command query is used as shorthand for an INIT command immediately followed by a FETC? command. The returned results are in ASCII string format. The string begins and ends with quotation marks.

Mode	All
<b>Remote Command</b>	:CALCulate:FPOWer:POWer[1,2,...,999]?
<b>Example</b>	:CALC:FPOW:POW1?

Notes	Option FP2 is required. See notes for Fast Power Fetch for return format.
Initial S/W Revision	A.14.00

### Binary Read Fast Power Measurement (Remote Command Only)

This command query is used as shorthand for an INIT command immediately followed by a FETC? command. The returned results are in a binary format.

Mode	All
<b>Remote Command</b>	:CALCulate:FPOWER:POWER[1,2,...,999]:READ? :CALCulate:FPOWER:POWER[1,2,...,999]:READ1?
<b>Example</b>	:CALC:FPOW:POW1:READ? :CALC:FPOW:POW1:READ1?
Notes	Option FP2 is required. Returns m 4 byte floating point binary values (Little-Endian), where m corresponds to the number of bandwidths defined.
Initial S/W Revision	A.14.00

### Diagnostic Binary Read Fast Power Measurement (Remote Command Only)

This command query is used as shorthand for an INIT command immediately followed by a FETC? command. The returned results are in a binary format. This command is used primarily for diagnostic purposes to test for ADC overloads and to visibly inspect the spectrum.

Mode	All
<b>Remote Command</b>	:CALCulate:FPOWER:POWER[1,2,...,999]:READ2?
<b>Example</b>	:CALC:FPOW:POW1:READ2?
Notes	Option FP2 is required. Note: Spectrum data is only returned if the IncludePowerSpectrum parameter is set to True. If IncludePowerSpectrum is False, the number of spectrum points will be zero (0). Units of the returned values are dependent on the Function parameter per channel (e.g. dBm for BandPower, Hz for PeakFrequency). Returns binary data (Little-Endian) that contains information on m amount of channels, along with ADC over range and full spectrum data. The following is the binary format of the response. Bandwidth Return Value 1. Number of channels specified, m [4 byte int] 2. Declared function result for the 1st specified channel [4 byte float]



---

	3. Declared function result for the 2nd specified channel [4 byte float]
	...
	(m + 1). Declared function result for the last (mth) specified channel [4 byte float]
	ADC Over Range
	1. ADC over-range occurred (1: true, 0: false) [2 byte short]
	Spectrum Data
	1. Number of points in the spectrum data, k [4 byte int]
	2. Start frequency of spectrum data (Hz) [8 byte double]
	3. Step frequency of spectrum data (Hz) [8 byte double]
	4. FFT bin at 1st point (dBm) [4 byte float]
	5. FFT bin at 2nd point (dBm) [4 byte float]
	...
	(k + 3). FFT bin at last (kth) point (dBm) [4 byte float]

---

Initial S/W Revision	A.14.00
-------------------------	---------

---

### Format Data: Numeric Data (Remote Command Only)

This command specifies the format of the trace data input and output. It specifies the formats used for trace data during data transfer across any remote port. It affects only the data format for setting and querying trace data for the :TRACe[:DATA], TRACe[:DATA]?, :CALCulate:DATA[n]? and FETCh:SANalyzer [n]? commands and queries.

---

<b>Remote Command</b>	:FORMat[:TRACe][:DATA] ASCii INTEger,32 REAL,32  REAL,64 :FORMat[:TRACe][:DATA]?
<b>Notes</b>	The query response is: ASCii: ASC,8 REAL,32: REAL,32 REAL,64: REAL,64 INTEger,32: INT,32 When the numeric data format is REAL or ASCii, data is output in the current Y Axis unit. When the data format is INTEger, data is output in units of m dBm (.001 dBm). The INT,32 format returns binary 32-bit integer values in internal units (m dBm), in a definite length block.
<b>Dependencies</b>	Sending a data format spec with an invalid number (for example, INT,48) generates no error. The analyzer simply uses the default (8 for ASCii, 32 for INTEger, 32 for REAL). Sending data to the analyzer which does not conform to the current FORMat specified, results in an error. Sending ASCII data when a definite block is expected generates message -161 "Invalid Block Data" and sending a definite block when ASCII data is expected generates message -121 "Invalid Character in Number".
<b>Preset</b>	ASCii
<b>Backwards Compatibility</b>	Note that the INT,32 format is only applicable to the command, TRACe:DATA. This preserves

---

Notes	backwards compatibility for the Swept SA measurement. For all other commands/queries which honor FORMat:DATA, if INT,32 is sent the analyzer will behave as though it were set to REAL,32.
Initial S/W Revision	Prior to A.02.00

The specs for each output type follow:

ASCIi - Amplitude values are in ASCII, in the current Y Axis Unit, one ASCII character per digit, values separated by commas, each value in the form:

SX.YYYYYEsZZ

Where:

S = sign (+ or -)

X = one digit to left of decimal point

Y = 5 digits to right of decimal point

E = E, exponent header

s = sign of exponent (+ or -)

ZZ = two digit exponent

REAL,32 - Binary 32-bit real values in the current Y Axis Unit, in a definite length block.

REAL,64 - Binary 64-bit real values in the current Y Axis Unit, in a definite length block.

### Format Data: Byte Order (Remote Command Only)

This command selects the binary data byte order for data transfer and other queries. It controls whether binary data is transferred in normal or swapped mode. This command affects only the byte order for setting and querying trace data for the :TRACe[:DATA], TRACe[:DATA]? , :CALCulate:DATA[n]? and FETCh:SANalyzer[n]? commands and queries.

By definition any command that says it uses FORMat:DATA uses any format supported by FORMat:DATA.

The NORMal order is a byte sequence that begins with the most significant byte (MSB) first, and ends with the least significant byte (LSB) last in the sequence: 1|2|3|4. SWAPped order is when the byte sequence begins with the LSB first, and ends with the MSB last in the sequence: 4|3|2|1.

<b>Remote Command</b>	:FORMat:BORDer NORMal   SWAPped :FORMat:BORDer?
Preset	NORMal
Initial S/W Revision	Prior to A.02.00

## Meas Setup

Displays the setup menu for the currently selected measurement. The functions included in the measurement setup menu include setting the parameters for the carriers, offsets, bandwidths, measurement methods and types. This menu also allows you to turn noise correction on and off.

Key Path	Front-panel key
Initial S/W Revision	Prior to A.02.00

### Average/Hold Number

Specifies the number of measurement averages used to calculate the measurement result. The average will be displayed at the end of each sweep. After the specified number of average counts, the average mode (termination control) setting determines the average action.

Key Path	Meas Setup
Mode	SA, WCDMA, C2K, WIMAX OFDMA, TD-SCDMA, 1xEVDO, DVB-T/H, DTMB (CTTB), ISDB-T, CMMB, LTE, LTE-TDD, Digital Cable TV, MSR, LTEAFDD, LTEATDD
<b>Remote Command</b>	[:SENSe]:ACPower:AVERage:COUNT <integer> [:SENSe]:ACPower:AVERage:COUNT? [:SENSe]:ACPower:AVERage[:STATe] OFF ON 0 1 [:SENSe]:ACPower:AVERage[:STATe]?
<b>Example</b>	ACP:AVER:COUN 250 ACP:AVER:COUN? ACP:AVER OFF ACP:AVER?
Notes	You must be in the mode that includes ACP measurements to use this command. Use :INSTRument:SElect to set the mode.
Preset	10 ON
State Saved	Saved in instrument state.
Min	1
Max	1000
<b>Backwards Compatibility SCPI</b>	[:SENSe]:ACPR:AVERage:COUNT [:SENSe]:MCPower:AVERage:COUNT (PSA Power Suite, PSA W-CDMA, PSA cdma2000 )
Initial S/W Revision	Prior to A.02.00
Modified at S/W Revision	A.02.00, A.03.00

## Avg Mode

Enables you to set the averaging mode. This determines the averaging action after the specified number of data acquisitions (average count) is reached.

When set to Exponential (Exp) the measurement averaging continues using the specified number of averages to compute each averaged value. The average will be displayed at the end of each sweep.

When set to Repeat, the measurement resets the average counter each time the specified number of averages is reached.

<b>Key Path</b>	Meas Setup
<b>Mode</b>	SA, WCDMA, C2K, WIMAX OFDMA, TD-SCDMA, 1xEVDO, DVB-T/H, DTMB (CTTB), ISDB-T, CMMB, LTE, LTETDD, Digital Cable TV, MSR, LTEAFDD, LTEATDD
<b>Remote Command</b>	[ :SENSe ] :ACPpower:AVERage:TCONtrol EXPonential   REPEAT [ :SENSe ] :ACPpower:AVERage:TCONtrol ?
<b>Example</b>	ACP:AVER:TCON EXP ACP:AVER:TCON ?
<b>Notes</b>	You must be in the mode that includes ACP measurements to use this command. Use :INSTRument:SElect to set the mode.
<b>Preset</b>	EXPonential
<b>State Saved</b>	Saved in instrument state.
<b>Range</b>	Exp Repeat
<b>Backwards Compatibility SCPI</b>	[ :SENSe ] :ACPR:AVERage:TCONtrol
<b>Initial S/W Revision</b>	Prior to A.02.00
<b>Modified at S/W Revision</b>	A.02.00, A.03.00

## Carrier Setup (This menu is unavailable in MSR )

Accesses a menu that contains Carriers, Ref Carrier, Ref Car Freq, Ref Car Pwr and Configure Carriers.

<b>Key Path</b>	Meas Setup
<b>Initial S/W Revision</b>	Prior to A.02.00

## Carriers

Specifies the number of carriers to be measured.

<b>Key Path</b>	Meas Setup, Carrier Setup, Configure Carriers
<b>Mode</b>	SA, WCDMA, C2K, WIMAX OFDMA, 1xEVDO, TD-SCDMA, DVB-T/H, DTMB (CTTB), ISDB-T, CMMB, LTE, LTETDD, Digital Cable TV, LTEAFDD, LTEATDD

<b>Remote Command</b>	<code>[ :SENSe ] :ACPower:CARRier [1]   2 :COUNT &lt;integer&gt;</code> <code>[ :SENSe ] :ACPower:CARRier [1]   2 :COUNT?</code>
<b>Example</b>	<code>ACP:CARR:COUN 1</code> <code>ACP:CARR:COUN?</code>
<b>Notes</b>	Carrier sub op code. 1 for BTS, 2 for MS. Default is BTS. Note that Carrier sub op code 2 is supported only in Non-SA modes. In the SA mode, Carrier sub op code 1 is used for both BTS and MS. You must be in the mode that includes ACP measurements to use this command. Use <code>:INSTrument:SElect</code> to set the mode. For LTE-Advanced FDD/TDD mode, this key is blank. In order to keep backwards compatible with the legacy LTE FDD/TDD, the <code>scpi</code> command is supported in LTE & LTE-A converged application.
<b>Dependencies</b>	When Number of Carriers is 1, Ref Carrier is grayed out. If N9060A-5FP license is enabled, Max of Carrier is 18, otherwise, Max of Carrier is 12.
<b>Couplings</b>	Changing this parameter might affect the Span.
<b>Preset</b>	1
<b>State Saved</b>	Saved in instrument state.
<b>Min</b>	1
<b>Max</b>	Refer to Dependencies item.
<b>Initial S/W Revision</b>	Prior to A.02.00
<b>Modified at S/W Revision</b>	A.02.00, A.03.00

## Ref Carrier

Sets the reference carrier. Relative power measurements are made from the reference carrier.

If set to Auto, the measurement selects the carrier with the highest power as the reference carrier and the Ref Carrier parameter is updated. If a value is entered when Ref Carrier Mode is set to Auto, the mode changes to Man.

If set to Man, the value that you enter for the Ref Carrier is used as the reference carrier.

<b>Key Path</b>	Meas Setup, Carrier Setup
<b>Mode</b>	SA, WCDMA, C2K, WIMAX OFDMA, 1xEVDO, TD-SCDMA, DVB-T/H, DTMB (CTTB), ISDB-T, CMMB, LTE, LTE-TDD, Digital Cable TV, LTEAFDD, LTEATDD
<b>Remote Command</b>	<code>[ :SENSe ] :ACPower:CARRier [1]   2 :RCARrier &lt;integer&gt;</code> <code>[ :SENSe ] :ACPower:CARRier [1]   2 :RCARrier?</code> <code>[ :SENSe ] :ACPower:CARRier [1]   2 :RCARrier:AUTO OFF ON 0 1</code> <code>[ :SENSe ] :ACPower:CARRier [1]   2 :RCARrier:AUTO?</code>
<b>Example</b>	<code>ACP:CARR:RCAR 1</code>

	ACP:CARR:RCAR? ACP:CARR:RCAR:AUTO OFF ACP:CARR:RCAR:AUTO?
Notes	<p>Carrier sub op code. 1 for BTS, 2 for MS. Default is BTS.</p> <p>Note that Carrier sub op code 2 is supported only in Non-SA modes.</p> <p>In the SA mode, Carrier sub op code 1 is used for both BTS and MS.</p> <p>You must be in the mode that includes ACP measurements to use this command. Use :INSTrument:SElect to set the mode.</p> <p>For LTE-Advanced FDD/TDD mode, this key is blank. In order to keep backwards compatible with the legacy LTE FDD/TDD, the scpi command is supported in LTE &amp; LTE-A converged application.</p>
Dependencies	If there is only one carrier, this key will be grayed out.
Couplings	<p>If you enter a carrier value that is currently configured as having no power present, that carrier will be changed to having power present.</p> <p>If you enter a ref carrier this parameter will be set to manual.</p>
Preset	Auto determined
State Saved	Saved in instrument state.
Min	1
Max	Number of available carriers
<b>Backwards Compatibility SCPI</b>	[ :SENSe ] :MCPower:RCARrier [ 1 ]   2 (PSA Power Suite)
Initial S/W Revision	Prior to A.02.00
Modified at S/W Revision	A.02.00, A.03.00

## Ref Car Freq

Sets the reference carrier frequency.

Key Path	Meas Setup, Carrier Setup
Mode	SA, WCDMA, C2K, WIMAX OFDMA, 1xEVDO, TD-SCDMA, DVB-T/H, DTMB (CTTB), ISDB-T, CMMB, LTE, LTETDD, Digital Cable TV, LTEAFDD, LTEATDD
<b>Remote Command</b>	<pre>[ :SENSe ] :ACPpower:CARRier [ 1 ]   2 :RCFRrequency &lt;freq&gt; [ :SENSe ] :ACPpower:CARRier [ 1 ]   2 :RCFRrequency? [ :SENSe ] :ACPpower:CARRier [ 1 ]   2 :RCFRrequency:AUTO OFF ON 0 1 [ :SENSe ] :ACPpower:CARRier [ 1 ]   2 :RCFRrequency:AUTO?</pre>
<b>Example</b>	<pre>ACP:CARR:RCFR 250 MHz ACP:CARR:RCFR? ACP:CARR:RCFR:AUTO OFF</pre>

## ACP:CARR:RCFR:AUTO?

## Notes

Carrier sub op code. 1 for BTS, 2 for MS. Default is BTS.

Note that Carrier sub op code 2 is supported only in Non-SA modes.

In the SA mode, Carrier sub op code 1 is used for both BTS and MS.

You must be in the mode that includes ACP measurements to use this command. Use :INSTrument:SElect to set the mode.

For LTE-Advanced FDD/TDD mode, this key is blank. In order to keep backwards compatible with the legacy LTE FDD/TDD, the scpi command is supported in LTE & LTE-A converged application

## Couplings

LTE-Advanced FDD/TDD not supported the following couplings.

Coupled to the Center Frequency.

If the center frequency changes, the Ref Carrier Frequency is calculated using the following three steps;

$$\text{Ref Freq1} = \text{Ctr Freq} - (\text{Total of all Carrier Widths} / 2)$$

$$\text{Ref Freq2} = \text{Ref Freq1} + (\text{Total of all Carrier Widths up to Ref Carrier})$$

$$\text{Ref Freq} = \text{Ref Freq2} + (0.5 * \text{Carrier Width of Ref Carrier})$$

If reference carrier frequency changes the Center Frequency is calculated using the following three steps;

$$\text{Ctr Freq1} = \text{Ref Freq} - (0.5 * \text{Carrier Width of Ref Carrier})$$

$$\text{Ctr Freq2} = \text{Ctr Freq1} - (\text{Total of all Carrier Widths up to Ref Carrier})$$

$$\text{Ctr Freq} = \text{Ctr Freq2} + (\text{Total of all Carrier Widths} / 2)$$

This ensures that the carriers are always centered on the screen.

If there is only one carrier present the Reference Carrier Frequency will be the same as the Center Frequency.

Preset Calculated based on the current Center Frequency

State Saved Saved in instrument state.

Min -79.999995 MHz

Max Hardware Dependent:  
Option F03 = 3.079999995 GHz  
Option F07 = 7.574999995 GHz  
Option F13 = 13.799999995 GHz  
Option F26 = 26.549999995 GHz

Initial S/W Revision Prior to A.02.00

Modified at S/W Revision A.02.00, A.03.00

## Power Ref

Sets the power reference in the carrier that will be used to compute the relative values for the offsets.

Key Path	Meas Setup, Carrier Setup
Initial S/W Revision	Prior to A.02.00
Modified at S/W Revision	A.03.00, A.04.00

## Total Power

Sets the multi-carrier power reference.

When set to Auto, the carrier power result reflects the measured power value in the selected reference carrier.

When set to Man, the result is referenced to the last measured value, or you may specify the reference for the multi-carrier power measurement. Relative values are displayed, referenced to the “Power Reference” value.

Key Path	Meas Setup, Carrier Setup, Power Ref
Mode	SA, WCDMA, C2K, WIMAX OFDMA, TD-SCDMA, DVB-T/H, DTMB (CTTB), ISDB-T, CMMB, LTE, LTETDD, Digital Cable TV, MSR
Remote Command	[:SENSe]:ACPoweR:CARRier[1] 2[:POWeR] <real> [:SENSe]:ACPoweR:CARRier[1] 2[:POWeR]? [:SENSe]:ACPoweR:CARRier[1] 2:AUTO[:STATe] OFF ON 0 1 [:SENSe]:ACPoweR:CARRier[1] 2:AUTO[:STATe]?
Example	ACP:CARR 10 ACP:CARR? ACP:CARR:AUTO OFF ACP:CARR:AUTO?
Notes	Although the default value is defined, the value is recalculated by the measurement result just after measurement. Carrier sub op code: 1 for BTS, 2 for MS. Default is BTS. Carrier sub op code 2 is supported only in Non-SA modes. MS is not supported in MSR. In the SA mode, Carrier sub op code 1 is used for both BTS and MS. The Unit Terminator keys differ depending on whether or not the mode supports Y Axis Unit and also which Y Axis Unit is selected. You must be in the mode that includes ACP measurements to use this command. Use :INSTrument:SElect to set the mode. Power Ref State ([:SENSe]:ACPoweR:CARRier[1] 2:AUTO[:STATe]) is not available in MSR mode.
Dependencies	This key is available only when the Meas Type is TPreF. If the Meas Type is not TPreF, this key is grayed out.
Preset	0.0 ON
State Saved	Saved in instrument state.
Min	-200 dBm



Max	200 dBm
<b>Backwards Compatibility SCPI</b>	<code>[ :SENSe ] :MCPower :CARRier [1]   2 [ :POWer ]</code>
Initial S/W Revision	Prior to A.02.00
Modified at S/W Revision	A.02.00, A.03.00, A.04.00, A.10.00

## PSD

Sets the power spectral density in the carrier (main channel) that is used to compute the relative power spectral density values for the offsets when Meas Type is set to PSD Ref. When the PSD Ref state is set to Auto, this will be set to the measured carrier power spectral density.

Key Path	Meas Setup, Carrier Setup, Power Ref
Mode	SA, WCDMA, C2K, WIMAX OFDMA, TD-SCDMA, DVB-T/H, DTMB (CTTB), ISDB-T, CMMB, LTE, LTETDD, Digital Cable TV, MSR
<b>Remote Command</b>	<code>[ :SENSe ] :ACPPower :CARRier [1]   2 :CPSD &lt;real&gt;</code> <code>[ :SENSe ] :ACPPower :CARRier [1]   2 :CPSD?</code>
<b>Example</b>	ACP:CARR:CPSD 25 ACP:CARR:CPSD?
Notes	Although the default value is defined, the value is recalculated by the measurement result just after measurement. Carrier sub op code. 1 for BTS, 2 for MS. Default is BTS. MS is not supported in MSR. Note that Carrier sub op code 2 is supported only in Non-SA modes. In the SA mode, Carrier sub op code 1 is used for both BTS and MS. You must be in the mode that includes ACP measurements to use this command. Use :INSTrument:SElect to set the mode.
Dependencies	This key is available only when the Meas Type is PSDRef. If the Meas Type is not PSDRef, this key is grayed out.
Couplings	The value of PSD is automatically converted when PSD Unit is changed.
Preset	0.0
State Saved	Saved in instrument state.
Min	-999
Max	999
Initial S/W Revision	Prior to A.02.00
Modified at S/W Revision	A.02.00, A.03.00, A.04.00, A.10.00

## Configure Carriers

Accesses a menu that contains Carrier, Carrier Pwr Present, Carrier Width and Carrier Integ BW parameters.

Key Path	Meas Setup, Carrier Setup
Initial S/W Revision	Prior to A.02.00

## Carrier

Selects the carrier to configure for the current measurement.

Key Path	Meas Setup, Carrier Setup, Configure Carriers
Mode	SA, WCDMA, C2K, WIMAX OFDMA, 1xEVDO, TD-SCDMA, DVB-T/H, DTMB (CTTB), ISDB-T, CMMB, LTE, LTEFDD, Digital Cable TV
Couplings	Max value is the number of available carriers, so this value might change when the number of carriers is changed.
Preset	1
State Saved	No
Min	1
Max	Number of available carriers
Initial S/W Revision	Prior to A.02.00
Modified at S/W Revision	A.02.00, A.03.00

## Carrier Pwr Present

Configures the carriers for this measurement. It allows spaces to be inserted between carriers. Carriers with the power present parameter set to Yes are carriers, and those with the power present parameter set to No are spaces. Each carrier power present is set to Yes or No. The individual carriers can be set by selecting the desired carrier on the carrier menu key using the up down arrows, the knob, or numeric keypad, then toggling the carrier power present using the carrier power present menu key.

The query for this parameter returns the current values for all of the carriers. If a carrier is defined as having no power present, the power displayed will be relative to the reference carrier, otherwise the absolute power will be displayed.

If you change the carrier power present to no and that carrier is currently configured as the reference carrier, the next carrier to the left (or the right if there are no carriers to the left) will be assigned as the reference carrier. This also applies to the scenario where there are only two carriers configured as having power present and you configure only one carrier to have no power present.

Key Path	Meas Setup, Carrier Setup, Configure Carriers
Mode	SA, WCDMA, C2K, WIMAX OFDMA, 1xEVDO, TD-SCDMA, DVB-T/H, DTMB (CTTB), ISDB-T, CMMB, LTE, LTEFDD, Digital Cable TV, LTEAFDD, LTEATDD

<b>Remote Command</b>	<code>[ :SENSe ] :ACPower:CARRier [ 1 ]   2 :LIST:PPResent YES   NO, YES   NO, YES   NO, YES   NO, YES   NO, YES   NO, YES   NO</code> <code>[ :SENSe ] :ACPower:CARRier [ 1 ]   2 :LIST:PPResent?</code>
<b>Example</b>	ACP:CARR2:LIST:PPR YES ACP:CARR2:LIST:PPR?
<b>Notes</b>	Carrier sub op code. 1 for BTS, 2 for MS. Default is BTS. Note that Carrier sub op code 2 is supported only in Non-SA modes. In the SA mode, Carrier sub op code 1 is used for both BTS and MS. When setting these values remotely, the position in the list sent corresponds to the carrier. Missing values are not permitted, therefore if you want to change values 2 and 6 you must send all values up to 6. Subsequent values will remain unchanged, unless the number of values sent is greater than the number of carriers, then subsequent values will be ignored. For LTE-Advanced FDD/TDD mode, this key is blank. In order to keep backwards compatible with the legacy LTE FDD/TDD, the scpi command is supported in LTE & LTE-A converged application.
<b>Dependencies</b>	If there is only one carrier, this key will be grayed out.
<b>Couplings</b>	Coupled to the number of carriers. When the SCPI command is sent, the number of carriers will be set to the number of entries in the parameter list.
<b>Preset</b>	YES
<b>State Saved</b>	Saved in instrument state.
<b>Range</b>	Yes No
<b>Backwards Compatibility SCPI</b>	<code>[ :SENSe ] :MCPower:CARRier [ 1 ]   2 :LIST:PPResent (PSA Power Suite)</code>
<b>Initial S/W Revision</b>	Prior to A.02.00
<b>Modified at S/W Revision</b>	A.02.00, A.03.00

## Carrier Spacing

Sets the width of the carrier spacing. This will be the value applied to all the current slots, whether they are carriers or spaces.

Enter each carrier spacing value individually by selecting the desired carrier on the carrier menu key using the up down arrows, the knob, or the numeric keypad, then enter the carrier width using the carrier spacing menu key.

<b>Key Path</b>	Meas Setup, Carrier Setup, Configure Carriers
<b>Mode</b>	SA, WCDMA, C2K, WIMAX OFDMA, 1xEVDO, TD-SCDMA, DVB-T/H, DTMB (CTTB), ISDB-T, CMMB, LTE, LTE-TDD, Digital Cable TV, LTEAFDD, LTEATDD
<b>Remote Command</b>	<code>[ :SENSe ] :ACPower:CARRier [ 1 ]   2 :LIST:WIDTh &lt;freq&gt;, &lt;freq&gt;, &lt;freq&gt;, &lt;freq&gt;, &lt;freq&gt;, &lt;freq&gt;</code> <code>[ :SENSe ] :ACPower:CARRier [ 1 ]   2 :LIST:WIDTh?</code>
<b>Example</b>	ACP:CARR2:LIST:WIDT 25kHz ACP:CARR2:LIST:WIDT?

Notes	<p>Carrier sub op code. 1 for BTS, 2 for MS. Default is BTS.</p> <p>Note that Carrier sub op code 2 is supported only in Non-SA modes.</p> <p>In the SA mode, Carrier sub op code 1 is used for both BTS and MS.</p> <p>When setting these values remotely, the position in the list sent corresponds to the carrier. Missing values are not permitted, therefore if you want to change values 2 and 6 you must send all values up to 6. Subsequent values will remain unchanged, unless the number of values sent is greater than the number of carriers, then subsequent values will be ignored.</p> <p>You must be in the mode that includes ACP measurements to use this command. Use :INSTrument:SElect to set the mode.</p> <p>For LTE-Advanced FDD/TDD mode, this key is blank. In order to keep backwards compatible with the legacy LTE FDD/TDD, the scpi command is supported in LTE &amp; LTE-A converged application.</p>
Couplings	<p>Coupled to the number of carriers. When the SCPI command is sent, the number of carriers will be set to the number of entries in the parameter list.</p> <p>Changing Carrier Spacing might affect the Span.</p>
Preset	<p>SA, WCDMA: 5 MHz</p> <p>WIMAX OFDMA: 10 MHz</p> <p>C2K: 1.25 MHz</p> <p>1xEVDO: 1.25 MHz</p> <p>TD-SCDMA: 1.6 MHz</p> <p>DVB-T/H: 8 MHz</p> <p>DTMB (CTTB): 8 MHz</p> <p>ISDB-T: 6 MHz</p> <p>CMMB: 8 MHz</p> <p>LTE: 5 MHz</p> <p>LTETDD: 5 MHz</p> <p>Digital Cable TV: 8 MHz</p>
State Saved	Saved in instrument state.
Min	0 Hz
Max	1 GHz
<b>Backwards Compatibility SCPI</b>	[[:SENSE]:MCPower:CARRier[1] 2:LIST:WIDTh (PSA Power Suite)
Initial S/W Revision	Prior to A.02.00
Modified at S/W Revision	A.02.00, A.03.00

### Measurement Noise Bandwidth

Specifies the Measurement Noise Bandwidth used to calculate the power in the carriers.

Each Measurement Noise Bandwidth value is entered individually by selecting the desired carrier on the carrier menu key using the up down arrows, the knob, or the numeric keypad. Then enter the measurement noise bandwidth using the measurement noise bandwidth key.

Key Path	Meas Setup, Carrier Setup, Configure Carriers
Mode	SA, WCDMA, C2K, WIMAX OFDMA, TD-SCDMA, 1xEVDO, DVB-T/H, DTMB (CTTB), ISDB-T, CMMB, LTE, LTEFDD, Digital Cable TV, LTEAFDD, LTEATDD
Remote Command	<code>[ :SENSe]:ACPower:CARRier[1] 2:LIST:BANDwidth[:INTEgration] &lt;freq&gt;, &lt;freq&gt;, &lt;freq&gt;, &lt;freq&gt;, &lt;freq&gt;</code> <code>[ :SENSe]:ACPower:CARRier[1] 2:LIST:BANDwidth[:INTEgration]?</code>
Example	ACP:CARR2:LIST:BAND 25kHz ACP:CARR2:LIST:BAND?
Notes	In the WCDMA mode, the preset/default value is defined as 3.84 MHz. But internally, 4.6848 MHz is used as the default value. Carrier sub op code. 1 for BTS, 2 for MS. Default is BTS. Note that Carrier sub op code 2 is supported only in Non-SA modes. In the SA mode, Carrier sub op code 1 is used for both BTS and MS. When setting these values remotely, the position in the list sent corresponds to the carrier. Missing values are not permitted, therefore if you want to change values 2 and 6 you must send all values up to 6. Subsequent values will remain unchanged, unless the number of values sent is greater than the number of carriers, then subsequent values will be ignored. You must be in the mode that includes ACP measurements to use this command. Use <code>:INSTrument:SElect</code> to set the mode. For LTE-Advanced FDD/TDD mode, this key is blank. In order to keep backwards compatible with the legacy LTE FDD/TDD, the <code>scpi</code> command is supported in LTE & LTE-A converged application.
Couplings	Coupled to the number of carriers. When the SCPI command is sent, the number of carriers is set to the number of entries in the parameter list.
Preset	SA: 2 MHz WCDMA: 3.84 MHz WIMAX OFDMA: 10 MHz C2K: 1.23MHz TD-SCDMA: 1.28 MHz 1xEVDO: 1.23 MHz DVB-T/H: 7.61 MHz DTMB (CTTB): 7.56 MHz ISDB-T: 5.6 MHz CMMB: 7.512 MHz LTE, LTEFDD: 4.515 MHz 4.5 MHz Digital Cable TV: 8.0 MHz
State Saved	Saved in instrument state.
Min	10 Hz
Max	1 GHz
Backwards Compatibility SCPI	<code>[ :SENSe]:ACPower:BANDwidth:INTEgration</code> <code>[ :SENSe]:ACPower:BWIDth:INTEgration</code> <code>[ :SENSe]:ACPower:CARRier[1] 2:LIST:BWIDth[:INTEgration]</code>

	<code>[ :SENSe ] :MCPower :CARRier [ 1 ]   2 :LIST :BANDwidth [ :INTEgration ]</code> (PSA Power Suite)
	<code>[ :SENSe ] :MCPower :CARRier [ 1 ]   2 :LIST :BWIDTh [ :INTEgration ]</code> (PSA Power Suite)
Initial S/W Revision	Prior to A.02.00
Modified at S/W Revision	A.02.00, A.03.00

## Method for Carrier

Accesses the carrier configuration method settings.

Key Path	Meas Setup, Carrier Setup, Configure Carriers
Mode	SA, WCDMA, WIMAX OFDMA, TD-SCDMA, DVB-T/H, DTMB (CTTB), ISDB-T, CMMB, LTE, LTETDD, Digital Cable TV, LTEAFDD, LTEATDD
Remote Command	<code>[ :SENSe ] :ACPpower :CARRier [ 1 ]   2 :LIST :FILTer [ :RRC ] [ :STATE ] ON   OFF   1   0, ON   OFF   1   0, ON   OFF   1   0, ON   OFF   1   0, ON   OFF   1   0, ON   OFF   1   0</code>  <code>[ :SENSe ] :ACPpower :CARRier [ 1 ]   2 :LIST :FILTer [ :RRC ] [ :STATE ] ?</code>
Example	ACP:CARR:LIST:FILT 0,0,0,0 ACP:CARR:LIST:FILT?
Notes	The binary values translate as follows: 1 ON = RRC Weighted 0 OFF = Integ BW Maximum of Array length depends on the number of carriers. You must be in the mode that includes ACP measurements to use this command. Use :INSTrument:SElect to set the mode. For LTE-Advanced FDD/TDD mode, this key is blank. In order to keep backwards compatible with the legacy LTE FDD/TDD, the scpi command is supported in LTE & LTE-A converged application.
Preset	SA, LTE, LTETDD: OFF WCDMA: ON WIMAX OFDMA: OFF TD-SCDMA: ON DVB-T/H: OFF DTMB (CTTB): ON ISDB-T, CMMB: OFF Digital Cable TV: OFF
State Saved	Saved in instrument state.
Range	IntegBW RRC Weight
Initial S/W Revision	Prior to A.02.00
Modified at S/W Revision	A.02.00, A.03.00

## Filter Alpha for Carrier

Inputs the alpha value for the filter used in the current carrier configuration.

Key Path	Meas Setup, Carrier Setup, Configure Carriers, Method, RRC Weighted
Mode	SA, WCDMA, WIMAX OFDMA, TD-SCDMA, DVB-T/H, DTMB (CTTB), ISDB-T, CMMB, LTE, LTETDD, Digital Cable TV, LTEAFDD, LTEATDD
Remote Command	<code>[ :SENSe ] :ACPoweR :CARRier [ 1 ]   2 :LIST :FILTer :ALPHA &lt;real&gt;, &lt;real&gt;, &lt;real&gt;, &lt;real&gt;, &lt;real&gt;, &lt;real&gt;</code>  <code>[ :SENSe ] :ACPoweR :CARRier [ 1 ]   2 :LIST :FILTer :ALPHA?</code>
Example	ACP:CARR2:LIST:FILT:ALPH 0.5 ACP:CARR2:LIST:FILT:ALPH?
Notes	You must be in the mode that includes ACP measurements to use this command. Use <code>:INSTrument:SElect</code> to set the mode.  For LTE-Advanced FDD/TDD mode, this key is blank. In order to keep backwards compatible with the legacy LTE FDD/TDD, the <code>scpi</code> command is supported in LTE & LTE-A converged application.
Preset	0.22 C2K: No DTMB (CTTB): 0.05 Digital Cable TV: 0.15
State Saved	Saved in instrument state.
Min	0.01
Max	1.0
Initial S/W Revision	Prior to A.02.00
Modified at S/W Revision	A.02.00, A.03.00

## Carrier Coupling

Couples carrier settings to carrier #1. The coupled parameters are Carrier Power Present, Carrier Spacing, Measurement Noise Bandwidth, Method, and Filter Alpha.

Parameter Name	Carrier Coupling
Key Path	Meas Setup, Carrier Setup, Configure Carriers
Key Type	Binary
Mode	SA, WCDMA, C2K, WIMAX OFDMA, 1xEVDO, TD-SCDMA, DVB-T/H, DTMB (CTTB), ISDB-T, CMMB, LTE, LTETDD, Digital Cable TV, LTEAFDD, LTEATDD
Remote Command	<code>[ :SENSe ] :ACPoweR :CARRier [ 1 ]   2 :LIST :COUple OFF   ON   0   1, OFF   ON   0   1, OFF   ON   0   1, OFF   ON   0   1, OFF   ON   0   1, OFF   ON   0   1, OFF   ON   0   1</code>  <code>[ :SENSe ] :ACPoweR :CARRier [ 1 ]   2 :LIST :COUple?</code>
Example	ACP:CARR:LIST:COUP OFF ACP:CARR:LIST:COUP?
Notes	Carrier sub op code. 1 for BTS, 2 for MS. Default is BTS.

	<p>Note that Carrier sub op code 2 is supported only in Non-SA modes. In the SA mode, Carrier sub op code 1 is used for both BTS and MS. You must be in the mode that includes ACP measurements to use this command. Use :INSTrument:SElect to set the mode. For LTE-Advanced FDD/TDD mode, this key is blank. In order to keep backwards compatible with the legacy LTE FDD/TDD, the scpi command is supported in LTE &amp; LTE-A converged application.</p>
Couplings	<p>When Couple is selected, the carrier settings are coupled to carrier #1. Coupled parameters are Carrier Power Present, Carrier Spacing, Measurement Noise Bandwidth, Method and Filter Alpha. When a setting is changed, the couple is set to Man automatically. Carrier #1 is always set to couple and cannot be changed. Couple/Man selection on the Carrier key is not displayed when selected carrier number is #1.</p>
Preset	ON
Force Restart	No
State Saved	Saved in instrument state.
Range	Couple Man
Initial S/W Revision	Prior to A.02.00
Modified at S/W Revision	A.02.00, A.03.00
Softkey Label	Carrier

### Offset/Limits

Accesses a menu of functions that contains Offset, Offset Freq/Offset To Edge, Offset Integ BW, Upper Offset Limit and Lower Offset parameters.

Key Path	Meas Setup
Initial S/W Revision	Prior to A.02.00
Modified at S/W Revision	A.13.00

### Select Offset

Selects the offset to configure.

Key Path	Meas Setup, Offset/Limits, Limits
Mode	SA, WCDMA, C2K, WIMAX OFDMA, TD-SCDMA, 1xEVDO, DVB-T/H, DTMB (CTTB), ISDB-T, CMMB, LTE, LTETDD, Digital Cable TV, MSR, LTEAFDD, LTEATDD
Preset	A
State Saved	Saved in instrument state.
Range	Offset A Offset B Offset C Offset D Offset E Offset F
Initial S/W Revision	Prior to A.02.00
Modified at S/W Revision	A.02.00, A.03.00, A.13.00



## Offset Freq

This parameter determines the frequency difference between the center of the main channel and the center of the carrier.

Each Offset Freq state value is entered individually by selecting the desired carrier on the carrier menu key using the up down arrows, RPG or numeric keypad. Then enter the Offset Freq State using the Offset Frequency key.

The list contains up to six (6) entries, depending on the mode selected, for offset frequencies. Each offset frequency in the list corresponds to a reference bandwidth in the bandwidth list.

An offset frequency of zero turns the display of the measurement for that offset off, but the measurement is still made and reported. You can turn off (not use) specific offsets with the `[:SENSe]:ACP:OFFSet:LIST:STATe` command.

Turning the offset off has the same effect as setting the frequency of the offset to 0 Hz and will cause it to be removed from the results screen.

<b>Key Path</b>	Meas Setup, Offset/Limits
<b>Mode</b>	SA, WCDMA, C2K, WIMAX OFDMA, TD-SCDMA, 1xEVDO, DVB-T/H, DTMB (CTTB), ISDB-T, CMMB, LTE, LTE-TDD, Digital Cable TV, MSR, LTEAFDD, LTEATDD
<b>Remote Command</b>	<pre>[:SENSe]:ACPower:OFFSet[1] 2[:OUTer]:LIST[:FREQuency] &lt;freq&gt;, &lt;freq&gt;, &lt;freq&gt;, &lt;freq&gt;, &lt;freq&gt;, &lt;freq&gt;  [:SENSe]:ACPower:OFFSet[1] 2[:OUTer]:LIST[:FREQuency]?  [:SENSe]:ACPower:OFFSet[1] 2[:OUTer]:LIST:STATe OFF   ON   0   1, OFF   ON   0   1, OFF   ON   0   1, OFF   ON   0   1, OFF   ON   0   1, OFF   ON   0   1  [:SENSe]:ACPower:OFFSet[1] 2[:OUTer]:LIST:STATe?</pre>
<b>Example</b>	<pre>ACP:OFFS1:LIST 0,0,0,0,0,0 ACP:OFFS1:LIST? ACP:OFFS2:LIST:STAT 1,1,0,0,0,0 ACP:OFFS2:LIST:STAT?</pre>
<b>Notes</b>	<p>The label for this menu key will change depending on the currently selected radio standard or mode. For cdma2000 the label for the menu key will be Offset to Edge. For all other supported standards the label will be Offset Freq.</p> <p>When setting these values remotely, the position in the list sent corresponds to the offset. Missing values are not permitted, unless the number of values sent is greater than the number of carriers, then subsequent values will be ignored.</p> <p>Offset sub op code. 1 for BTS, 2 for MS. Default is BTS.</p> <p>Note that Offset sub op code 2 is supported only in Non-SA modes.</p> <p>In the SA mode, Offset sub op code 1 is used for both BTS and MS.</p> <p>You must be in the mode that includes ACP measurements to use this command. Use <code>:INSTrument:SElect</code> to set the mode.</p>
<b>Couplings</b>	Changing Offset Frequency might affect the Span. See the Span key section for details.
<b>Preset</b>	SA: 3 MHz, 0 Hz, 0 Hz, 0 Hz, 0 Hz, 0 Hz 3 MHz, 0 Hz, 0 Hz, 0 Hz, 0 Hz, 0 Hz

---

<p>WCDMA: 5.0 MHz, 10.0 MHz, 0 Hz, 0 Hz, 0 Hz, 0 Hz 5.0 MHz, 10.0 MHz, 0 Hz, 0 Hz, 0 Hz, 0 Hz  WIMAX OFDMA: 10 MHz, 20 MHz, 0 Hz, 0 Hz, 0 Hz, 0 Hz  10 MHz, 20 MHz, 0 Hz, 0 Hz, 0 Hz, 0 Hz  C2K:750KHz, 1.980 MHz, 0 Hz, 0 Hz, 0 Hz, 0 Hz  885 kHz, 1.980 MHz, 0 Hz, 0 Hz, 0 Hz, 0 Hz  TD-SCDMA: 1.6 MHz, 3.2 MHz, 0 Hz, 0 Hz, 0 Hz, 0 Hz 1.6 MHz, 3.2 MHz, 0 Hz, 0 Hz, 0 Hz, 0 Hz  1xEVDO: 750KHz, 1.98MHz, 3.125MHz, 4.000MHz, 7.500MHz, 7.500MHz 885KHz, 1.98MHz,  3.125MHz, 4.000MHz, 7.500MHz, 7.500MHz  DVB-T/H: 8 MHz, 16 MHz, 0 Hz, 0 Hz, 0 Hz, 0 Hz  8 MHz, 16 MHz, 0 Hz, 0 Hz, 0 Hz, 0 Hz  DTMB (CTTB): 8 MHz, 16 MHz, 24 MHz, 32 MHz, 0 Hz, 0 Hz  8 MHz, 16 MHz, 24 MHz, 32 MHz, 0  Hz, 0 Hz  ISDB-T: 6 MHz, 12 MHz, 0 Hz, 0 Hz, 0 Hz, 0 Hz  6 MHz, 12 MHz, 0 Hz, 0 Hz, 0 Hz, 0 Hz  CMMB: 8 MHz, 16 MHz, 24 MHz, 32 MHz, 0 Hz, 0 Hz  8 MHz, 16 MHz, 24 MHz, 32 MHz, 0 Hz, 0  Hz  LTE, LTETDD, MSR, LTEAFDD, LTEATDD: 5 MHz, 10 MHz, 0, 0, 0, 0 5 MHz, 10 MHz, 0, 0, 0, 0  Digital Cable TV: 8 MHz, 16 MHz, 0 Hz, 0 Hz, 0 Hz, 0 Hz 8 MHz, 16 MHz, 0 Hz, 0 Hz, 0 Hz, 0 Hz  SA: ON, OFF, OFF, OFF, OFF, OFF ON, OFF, OFF, OFF, OFF, OFF  WCDMA: ON, ON, OFF, OFF, OFF, OFF ON, ON, OFF, OFF, OFF, OFF  WIMAX OFDMA: ON, ON, OFF, OFF, OFF, OFF ON, ON, OFF, OFF, OFF, OFF  TD-SCDMA: ON, ON, OFF, OFF, OFF, OFF ON, ON, OFF, OFF, OFF, OFF  DVB-T/H: ON, ON, OFF, OFF, OFF, OFF ON, ON, OFF, OFF, OFF, OFF  DTMB (CTTB): ON, ON, OFF, OFF, OFF, OFF ON, ON, OFF, OFF, OFF, OFF  CDMA1xEVDO: ON, ON, OFF, OFF, OFF, OFF  ON, ON, OFF, OFF, OFF, OFF  ISDB-T: ON, ON, OFF, OFF, OFF, OFF ON, ON, OFF, OFF, OFF, OFF  CMMB: ON, ON, ON, ON, OFF, OFF ON, ON, ON, ON, OFF, OFF  LTE, LTETDD, MSR, LTEAFDD, LTEATDD: ON, ON, OFF, OFF, OFF, OFF ON, OFF, OFF, OFF, OFF, OFF  Digital Cable TV: ON, ON, OFF, OFF, OFF, OFF ON, ON, OFF, OFF, OFF, OFF</p>	
State Saved	Saved in instrument state.
Min	0 Hz
Max	500 MHz
<b>Backwards Compatibility SCPI</b>	[[:SENSE]:MCPower:OFFSet[1] 2:LIST[:FREQuency] (PSA Power Suite)
Initial S/W Revision	Prior to A.02.00
Modified at S/W Revision	A.02.00, A.03.00, A.13.00

---

## Integ BW

Sets the Integration Bandwidth for the offsets. Each resolution bandwidth in the list corresponds to an offset frequency in the list defined by [[:SENSE]:ACP:OFFSet[n][:OUTer]:LIST[:FREQuency]].

Enter each value individually by selecting the desired offset on the offset menu key using the up down arrows, the knob, or the numeric keypad, then enter the Offset Integration Bandwidth using the Offset Integration Bandwidth menu key.

You can turn off (not use) specific offsets with the [[:SENSE]:ACP:OFFSet[n][:OUTer]:LIST:STATe command.

Key Path	Meas Setup, Offset/Limits
Mode	SA, WCDMA, C2K, WIMAX OFDMA, TD-SCDMA, 1xEVDO, DVB-T/H, DTMB (CTTB), ISDB-T, CMMB, LTE, LTE-TDD, Digital Cable TV, MSR, LTEAFDD, LTEATDD
Remote Command	<code>[ :SENSE]:ACPower:OFFSet[1] 2[:OUTer]:LIST:BANDwidth[:INTegration] &lt;freq&gt;, &lt;freq&gt;, &lt;freq&gt;, &lt;freq&gt;, &lt;freq&gt;, &lt;freq&gt;  [:SENSE]:ACPower:OFFSet[1] 2[:OUTer]:LIST:BANDwidth[:INTegration]?</code>
Example	ACP:OFFS2:LIST:BAND 2MHz, 2MHz, 2MHz, 2MHz, 2MHz, 2MHz ACP:OFFS2:LIST:BAND?
Notes	<p>When setting these values remotely, the position in the list sent corresponds to the offset. Missing values are not permitted i.e. if you want to change the second value, you must send all values up to it. Subsequent values will remain unchanged, unless the number of values sent is greater than the number of carriers, then subsequent values will be ignored.</p> <p>Offset sub op code. 1 for BTS, 2 for MS. Default is BTS.</p> <p>Note that Offset sub op code 2 is supported only in Non-SA modes.</p> <p>In the SA mode, Offset sub op code 1 is used for both BTS and MS.</p> <p>You must be in the mode that includes ACP measurements to use this command. Use :INSTrument:SElect to set the mode.</p>
Couplings	Changing Integ BW might affect the Span. See Span section for details.
Preset	<p>SA: 2 MHz, 2 MHz, 2 MHz, 2 MHz, 2 MHz, 2 MHz 2 MHz, 2 MHz, 2 MHz, 2 MHz, 2 MHz, 2 MHz</p> <p>WCDMA: 3.84 MHz, 3.84 MHz, 3.84 MHz, 3.84 MHz, 3.84 MHz, 3.84 MHz 3.84 MHz, 3.84 MHz, 3.84 MHz, 3.84 MHz</p> <p>WIMAX OFDMA: 10 MHz, 10 MHz, 10 MHz, 10 MHz, 10 MHz, 10 MHz 10 MHz, 10 MHz, 10 MHz, 10 MHz, 10 MHz, 10 MHz</p> <p>C2K: 30 kHz, 30 kHz, 30 kHz, 30 kHz, 30 kHz, 30 kHz 30 kHz, 30 kHz, 30 kHz, 30 kHz, 30 kHz, 30 kHz</p> <p>TD-SCDMA: 1.28 MHz, 1.28 MHz, 1.28 MHz, 1.28 MHz, 1.28 MHz, 1.28 MHz</p> <p>1xEVDO: C2K: 30 kHz, 30 kHz, 30 kHz, 30 kHz, 30 kHz, 30 kHz 30 kHz, 30 kHz, 30 kHz, 30 kHz, 30 kHz, 30 kHz</p> <p>DVB-T/H: 7.61 MHz, 7.61 MHz, 7.61 MHz, 7.61 MHz, 7.61 MHz, 7.61 MHz 7.61 MHz, 7.61 MHz, 7.61 MHz, 7.61 MHz, 7.61 MHz, 7.61 MHz</p> <p>DTMB (CTTB): 7.56 MHz, 7.56 MHz, 7.56 MHz, 7.56 MHz, 7.56 MHz, 7.56 MHz 7.56 MHz, 7.56 MHz, 7.56 MHz, 7.56 MHz, 7.56 MHz, 7.56 MHz</p> <p>ISDB-T: 5.6 MHz, 5.6 MHz, 5.6 MHz, 5.6 MHz, 5.6 MHz, 5.6 MHz 5.6 MHz, 5.6 MHz, 5.6 MHz, 5.6 MHz, 5.6 MHz, 5.6 MHz</p> <p>CMMB: 7.512 MHz, 7.512 MHz, 7.512 MHz, 7.512 MHz, 7.512 MHz, 7.512 MHz 7.512 MHz, 7.512 MHz, 7.512 MHz, 7.512 MHz, 7.512 MHz, 7.512 MHz</p> <p>LTE, LTE-TDD, MSR, LTEAFDD, LTEATDD: 4.515 MHz, 4.515 MHz, 4.515 MHz, 4.515 MHz, 4.515 MHz, 4.515 MHz 4.5 MHz, 4.5 MHz, 4.5 MHz, 4.5 MHz, 4.5 MHz, 4.5 MHz</p> <p>Digital Cable TV: 8.0 MHz, 8.0 MHz, 8.0 MHz, 8.0 MHz, 8.0 MHz, 8.0 MHz 8.0 MHz, 8.0 MHz, 8.0 MHz, 8.0 MHz, 8.0 MHz, 8.0 MHz</p>
State Saved	Saved in instrument state.
Min	10 Hz

Max	1 GHz
<b>Backwards Compatibility SCPI</b>	[:SENSe]:ACPower:OFFSet [1]   2:LIST:BWIDth[:INTEgration] [:SENSe]:ACPR:OFFSet [1]   2:LIST:BANDwidth [:SENSe]:ACPR:OFFSet [1]   2:LIST:BWIDth [:SENSe]:MCPower:OFFSet [1]   2:LIST:BANDwidth[:INTEgration] (PSA Power Suite) [:SENSe]:MCPower:OFFSet [1]   2:LIST:BWIDth[:INTEgration] (PSA Power Suite)
Initial S/W Revision	Prior to A.02.00
Modified at S/W Revision	A.02.00, A.03.00, A.13.00

### Offset BW

Accesses the offset bandwidth menu.

Key Path	Meas Setup, Offset/Limits
Initial S/W Revision	Prior to A.02.00

### Res BW

Sets the resolution bandwidth. If an unavailable bandwidth is entered with the numeric keypad, the closest available bandwidth is selected.

Key Path	Meas Setup, Offset/Limits
Mode	SA, WCDMA, C2K, WIMAX OFDMA, TD-SCDMA, 1xEVDO, DVB-T/H, DTMB (CTTB), ISDB-T, CMMB, LTE, LTE-TDD, Digital Cable TV, MSR, LTEAFDD, LTEATDD
<b>Remote Command</b>	[:SENSe]:ACPower:OFFSet [1]   2[:OUTer]:LIST:BANDwidth:RESolution <freq>, <freq>, <freq>, <freq>, <freq> [:SENSe]:ACPower:OFFSet [1]   2[:OUTer]:LIST:BANDwidth:RESolution? [:SENSe]:ACPower:OFFSet [1]   2[:OUTer]:LIST:BANDwidth:RESolution:AUTO ON   OFF   1   0, ON   OFF   1   0, ON   OFF   1   0, ON   OFF   1   0, ON   OFF   1   0, ON   OFF   1   0 [:SENSe]:ACPower:OFFSet [1]   2[:OUTer]:LIST:BANDwidth:RESolution:AUTO?
<b>Example</b>	ACP:OFFS2:LIST:BAND:RES 220kHz, 220kHz, 220kHz, 220kHz, 220kHz, 220kHz ACP:OFFS2:LIST:BAND:RES? ACP:OFFS2:LIST:BAND:RES:AUTO 1,1,1,1,1,1 ACP:OFFS2:LIST:BAND:RES:AUTO?
Notes	Offset sub op code. 1 for BTS, 2 for MS. Default is BTS. Note that Offset sub op code 2 is supported only in Non-SA modes. In the SA mode, Offset sub op code 1 is used for both BTS and MS.

	You must be in the mode that includes ACP measurements to use this command. Use :INSTrument:SElect to set the mode.
Dependencies	When Meas Method is RBW or FAST, this key is grayed out and disabled. If the key is pressed, an advisory message is generated. If the equivalent remote command is sent, a "Setting conflict" warning is generated.
Couplings	When Res BW Mode is AUTO, this value is exactly same as Res BW under BW key. And when this value is changed by user, Res BW Mode is also changed to Man.
Preset	SA: 220 kHz, 220 kHz, 220 kHz, 220 kHz, 220 kHz, 220 kHz WCDMA: 100 kHz, 100 kHz, 100 kHz, 100 kHz, 100 kHz, 100 kHz WIMAX OFDMA: 100 kHz, 100 kHz, 100 kHz, 100 kHz, 100 kHz, 100 kHz C2K: Method:RBW 30 kHz Method: IBW C2K: 15 kHz, 15 kHz, 15 kHz, 15 kHz, 15 kHz, 15 kHz 15 kHz, 15 kHz, 15 kHz, 15 kHz, 15 kHz, 15 kHz TD-SCDMA: 30 kHz, 30 kHz, 30 kHz, 30 kHz, 30 kHz, 30 kHz 1xEVDO: 30kHz, 30kHz, 30kHz, 30kHz, 30kHz, 30kHz  30kHz, 30kHz, 30kHz, 30kHz, 30kHz, 30kHz DVB-T/H: 39 kHz, 39 kHz, 39 kHz, 39 kHz, 39 kHz, 39 kHz 39 kHz, 39 kHz, 39 kHz, 39 kHz, 39 kHz, 39 kHz DTMB (CTTB): 39 kHz, 39 kHz, 39 kHz, 39 kHz, 39 kHz, 39 kHz 39 kHz, 39 kHz, 39 kHz, 39 kHz, 39 kHz, 39 kHz ISDB-T: 39 kHz, 39 kHz, 39 kHz, 39 kHz, 39 kHz, 39 kHz 39 kHz, 39 kHz, 39 kHz, 39 kHz, 39 kHz, 39 kHz CMMB: 39 kHz, 39 kHz, 39 kHz, 39 kHz, 39 kHz, 39 kHz 39 kHz, 39 kHz, 39 kHz, 39 kHz, 39 kHz, 39 kHz LTE, LTEFDD, MSR, LTEAFDD, LTEATDD: 100 kHz, 100 kHz, 100 kHz, 100 kHz, 100kHz, 100 kHz 100 kHz, 100 kHz, 100 kHz, 100 kHz, 100 kHz, 100 kHz Digital Cable TV: 39 kHz, 39 kHz, 39 kHz, 39 kHz, 39 kHz, 39 kHz 39 kHz, 39 kHz, 39 kHz, 39 kHz, 39 kHz, 39 kHz 1, 1, 1, 1, 1, 1
State Saved	Saved in instrument state.
Min	1 Hz
Max	8 MHz
<b>Backwards Compatibility SCPI</b>	[ :SENSE ] :ACPower:OFFSet [ 1 ]   2 :LIST:BWIDth:RESolution
Initial S/W Revision	Prior to A.02.00
Modified at S/W Revision	A.02.00, A.03.00, A.13.00

## Video BW

Enables you to change the analyzer post-detection filter (VBW).

<b>Key Path</b>	Meas Setup, Offset/Limits, Offset BW
<b>Mode</b>	SA, WCDMA, C2K, WIMAX OFDMA, TD-SCDMA, 1xEVDO, DVB-T/H, DTMB (CTTB), ISDB-T, CMMB, LTE, LTETDD, Digital Cable TV, MSR, LTEAFDD, LTEATDD
<b>Remote Command</b>	<pre>[ :SENSe]:ACPower:OFFSet [1]   2[:OUTer]:LIST:BANDwidth:VIDeo &lt;freq&gt;, &lt;freq&gt;, &lt;freq&gt;, &lt;freq&gt;, &lt;freq&gt;  [:SENSe]:ACPower:OFFSet [1]   2[:OUTer]:LIST:BANDwidth:VIDeo?  [:SENSe]:ACPower:OFFSet [1]   2[:OUTer]:LIST:BANDwidth:VIDeo:AUTO OFF   ON   0   1, OFF   ON   0   1, OFF   ON   0   1, OFF   ON   0   1, OFF   ON   0   1, OFF   ON   0   1  [:SENSe]:ACPower:OFFSet [1]   2[:OUTer]:LIST:BANDwidth:VIDeo:AUTO?</pre>
<b>Example</b>	<pre>ACP:OFFS2:LIST:BAND:VID 5MHz, 5MHz, 5MHz, 5MHz, 5MHz, 5MHz ACP:OFFS2:LIST:BAND:VID? ACP:OFFS2:LIST:BAND:VID:AUTO 0,0,0,0,1,1 ACP:OFFS2:LIST:BAND:VID:AUTO?</pre>
<b>Notes</b>	<p>The values shown in this table reflect the conditions after a Mode Preset.</p> <p>Offset sub op code. 1 for BTS, 2 for MS. Default is BTS.</p> <p>Note that Offset sub op code 2 is supported only in Non-SA modes.</p> <p>In the SA mode, Offset sub op code 1 is used for both BTS and MS.</p> <p>You must be in the mode that includes ACP measurements to use this command. Use :INSTrument:SElect to set the mode.</p> <p>.</p>
<b>Dependencies</b>	When Meas Method is RBW or FAST, this key is grayed out and disabled. If the key is pressed, an advisory message is generated. If the equivalent remote command is sent, a "Setting conflict" warning is generated.
<b>Preset</b>	<pre>SA: 22 kHz, 22 kHz, 22 kHz, 22 kHz, 22 kHz, 22 kHz WCDMA, WIMAX OFDMA: 1 MHz, 1 MHz, 1 MHz, 1 MHz, 1 MHz, 1 MHz C2K: 150 kHz, 150 kHz, 150 kHz, 150 kHz, 150 kHz, 150 kHz  150 kHz, 150 kHz, 150 kHz, 1150 kHz, 1150 kHz, 150 kHz TD-SCDMA: 300 kHz, 300 kHz, 300 kHz, 300 kHz, 300 kHz, 300 kHz 1xEVDO: 300KHz, 300KHz, 300KHz, 300KHz, 300KHz, 300KHz   300KHz, 300KHz, 300KHz, 300KHz, 300KHz, 300KHz DVB-T/H: 390 kHz, 390 kHz, 390 kHz, 390 kHz, 390 kHz, 390 kHz 390 kHz, 390 kHz, 390 kHz, 390 kHz, 390 kHz, 390 kHz DTMB (CTTB): 390 kHz, 390 kHz, 390 kHz, 390 kHz, 390 kHz, 390 kHz 390 kHz, 390 kHz, 390 kHz, 390 kHz, 390 kHz, 390 kHz ISDB-T: 390 kHz, 390 kHz, 390 kHz, 390 kHz, 390 kHz, 390 kHz 390 kHz, 390 kHz, 390 kHz, 390 kHz, 390 kHz, 390 kHz CMMB: 390 kHz, 390 kHz, 390 kHz, 390 kHz, 390 kHz, 390 kHz 390 kHz, 390 kHz, 390 kHz, 390 kHz, 390 kHz, 390 kHz LTE, LTETDD, MSR, LTEAFDD, LTEATDD: 1 MHz, 1 MHz, 1 MHz, 1 MHz, 1 MHz, 1 MHz Digital Cable TV: 390 kHz, 390 kHz, 390 kHz, 390 kHz, 390 kHz, 390 kHz 390 kHz, 390 kHz, 390 kHz, 390 kHz, 390 kHz, 390 kHz ON, ON, ON, ON, ON, ON</pre>

State Saved	Saved in instrument state.
Min	1 Hz
Max	50 MHz
<b>Backwards Compatibility SCPI</b>	<code>[ :SENSE]:ACPower:OFFSet [1]   2:LIST:BWIDth:VIDeo</code>
Initial S/W Revision	Prior to A.02.00
Modified at S/W Revision	A.02.00, A.03.00, A.13.00

## RBW Control

Accesses the resolution bandwidth control menu.

Key Path	Meas Setup, Offset/Limits, Offset BW
Initial S/W Revision	Prior to A.02.00

## Filter Type

Selects the type of bandwidth filter that is used.

Key Path	Meas Setup, Offset/Limits, Offset BW, RBW Control
Mode	SA, WCDMA, C2K, WIMAX OFDMA, TD-SCDMA, 1xEVDO, DVB-T/H, DTMB (CTTB), ISDB-T, CMMB, LTE, LTEFDD, Digital Cable TV, MSR, LTEAFDD,LTEATDD
<b>Remote Command</b>	<code>[ :SENSE]:ACPower:OFFSet [1]   2[:OUTer]:LIST:BA NDwidth:SHAPE GAUSSian   FLATtop, GAUSSian   FLATtop, GAUSSian   FLATtop, GAUSSian   FLATtop, GAUSSian   FLATtop, GAUSSian   FLATtop</code>  <code>[ :SENSE]:ACPower:OFFSet [1]   2[:OUTer]:LIST:BA NDwidth:SHAPE?</code>
<b>Example</b>	ACP:OFFS2:LIST:BA ND:SHAP FLAT, GAUS, GAUS, GAUS, GAUS, GAUS ACP:OFFS2:LIST:BA ND:SHAP?
Notes	Offset sub op code. 1 for BTS, 2 for MS. Default is BTS. Note that Offset sub op code 2 is supported only in Non-SA modes. In the SA mode, Offset sub op code 1 is used for both BTS and MS. You must be in the mode that includes ACP measurements to use this command. Use :INSTrument:SElect to set the mode.
Dependencies	When Res BW Mode for the offset is Auto, this key is grayed out and disabled. Since Res BW Mode for the offset is preset to Auto on changing Meas Method to RBW or FAST, this key is grayed out and disabled too. If the key is pressed, an advisory message is generated. If the equivalent remote command is sent, a "Setting conflict" warning is generated.
Couplings	See the description above
Preset	GAUSSian, GAUSSian, GAUSSian, GAUSSian, GAUSSian, GAUSSian
State Saved	Saved in instrument state.
Range	GAUSSian FLATtop

<b>Backwards Compatibility SCPI</b>	<code>[ :SENSe ] :ACPpower:OFFSet [ 1 ]   2 :LIST:BWIDth:SHAPE</code>
Initial S/W Revision	Prior to A.02.00
Modified at S/W Revision	A.02.00, A.03.00, A.13.00

### Filter BW

Selects a Gaussian filter based on its -3 dB (Normal) bandwidth or its -6 dB bandwidth.

Key Path	Meas Setup, Offset/Limits, Offset BW, RBW Control
Mode	SA, WCDMA, C2K, WIMAX OFDMA, TD-SCDMA, 1xEVDO, DVB-T/H, DTMB (CTTB), ISDB-T, CMMB, LTE, LTETDD, Digital Cable TV, MSR, LTEAFDD, LTEATDD
<b>Remote Command</b>	<code>[ :SENSe ] :ACPpower:OFFSet [ 1 ]   2 [ :OUTer ] :LIST:BWIDth:TYPE DB3   DB6, DB3   DB6, DB3   DB6, DB3   DB6, DB3   DB6</code>  <code>[ :SENSe ] :ACPpower:OFFSet [ 1 ]   2 [ :OUTer ] :LIST:BWIDth:TYPE?</code>
<b>Example</b>	ACP:OFFS2:LIST:BAND:TYPE DB3, DB3, DB3, DB3, DB3, DB3 ACP:OFFS2:LIST:BAND:TYPE?
Notes	Offset sub op code. 1 for BTS, 2 for MS. Default is BTS. Note that Offset sub op code 2 is supported only in Non-SA modes. In the SA mode, Offset sub op code 1 is used for both BTS and MS. You must be in the mode that includes ACP measurements to use this command. Use :INSTRument:SElect to set the mode.
Dependencies	When Filter Type is Flattop or Res BW Mode for the offset is Auto, this key is grayed out and disabled. Since Res BW Mode for the offset is preset to Auto on changing Meas Method to RBW or FAST, this key is grayed out and disabled too. If the key is pressed, an advisory message is generated. If the equivalent remote command is sent, a "Setting conflict" warning is generated.
Preset	DB3, DB3, DB3, DB3, DB3, DB3
State Saved	Saved in instrument state.
Range	-3 dB (Normal)   -6 dB
<b>Backwards Compatibility SCPI</b>	<code>[ :SENSe ] :ACPpower:OFFSet [ 1 ]   2 :LIST:BWIDth:TYPE</code>
Initial S/W Revision	Prior to A.02.00
Modified at S/W Revision	A.02.00, A.03.00, A.13.00

### Limits

Limits key accesses a menu of functions that contains Select Offset, Abs Limit, Rel Limit and Fail Mask parameters.

Key Path	Meas Setup, Offset/Limits
Initial S/W Revision	A.03.00



## Select Offset

Selects the offset to configure.

Key Path	Meas Setup, Offset/Limits, Limits
Mode	SA, WCDMA, C2K, WIMAX OFDMA, TD-SCDMA, 1xEVDO, DVB-T/H, DTMB (CTTB), ISDB-T, CMMB, LTE, LTE-TDD, Digital Cable TV, MSR, LTEAFDD, LTEATDD
Preset	A
State Saved	Saved in instrument state.
Range	Offset A Offset B Offset C Offset D Offset E Offset F
Initial S/W Revision	Prior to A.02.00
Modified at S/W Revision	A.02.00, A.03.00, A.13.00

## Abs Limit

Enters an absolute limit value, which sets the absolute amplitude levels to test against for each of the custom offsets. The list must contain six (6) entries. If there is more than one offset, the offset closest to the carrier channel is the first one in the list. [:SENSe]:ACP:OFFSet[n][:OUTer]:LIST:TEST selects the type of testing to be done at each offset.

You can turn off (not use) specific offsets with the [:SENSe]:ACP:OFFSet[n][:OUTer]:LIST:STATe command.

The query returns the six (6) sets of real numbers that are the current absolute amplitude test limits.

Key Path	Meas Setup, Offset/Limits, Limits
Mode	SA, WCDMA, C2K, WIMAX OFDMA, TD-SCDMA, 1xEVDO, DVB-T/H, DTMB (CTTB), ISDB-T, CMMB, LTE, LTE-TDD, Digital Cable TV, MSR, LTEAFDD, LTEATDD
Remote Command	[:SENSe]:ACP:OFFSet[1] 2[:OUTer]:LIST:ABSolute <real>, <real>, <real>, <real>, <real>, <real> [:SENSe]:ACP:OFFSet[1] 2[:OUTer]:LIST:ABSolute?
Example	ACP:OFFS2:LIST:ABS -10, -10, -10, -10, -10, -10 ACP:OFFS2:LIST:ABS?
Notes	Offset sub op code. 1 for BTS, 2 for MS. Default is BTS. Note that Offset sub op code 2 is supported only in Non-SA modes. In the SA mode, Offset sub op code 1 is used for both BTS and MS. You must be in the mode that includes ACP measurements to use this command. Use :INSTrument:SElect to set the mode.
Couplings	None If current mode is DTMB (CTTB) or CMMB and current device type is Transmitter, the value from position 2 to position 4 are coupled, changing any one will change the others.
Preset	SA: 0dBm, 0 dBm, 0 dBm, 0 dBm, 0 dBm, 0 dBm 0dBm, 0 dBm, 0 dBm, 0 dBm, 0 dBm, 0 dBm WCDMA: 50 dBm, 50 dBm, 50 dBm, 50 dBm, 50 dBm, 50 dBm 50 dBm, 50 dBm, 50 dBm, 50 dBm, 50 dBm, 50 dBm dBm, 50 dBm, 50 dBm

	<p>C2K: 50 dBm, 50 dBm, 50 dBm, 50 dBm, 50 dBm, 50 dBm 50 dBm, 50 dBm, 50 dBm, 50 dBm, 50 dBm, 50 dBm</p> <p>WIMAX OFDMA: 50,50,50,50,50,50</p> <p>TD-SCDMA: 50 dBm, 50 dBm, 50 dBm, 50 dBm, 50 dBm, 50 dBm 50 dBm, 50 dBm, 50 dBm, 50 dBm, 50 dBm, 50 dBm</p> <p>1xEVDO: -27dBm, -27dBm, -13dBm, -13dBm, -13dBm, -13dBm  -27dBm, -27dBm, -13dBm, -13dBm, -13dBm, -13dBm</p> <p>DVB-T/H: 50 dBm, 50 dBm, 50 dBm, 50 dBm, 50 dBm, 50 dBm 50 dBm, 50 dBm, 50 dBm, 50 dBm, 50 dBm, 50 dBm</p> <p>DTMB (CTTB): 11.14 dBm, 11.14dBm, 11.14 dBm, 11.14 dBm, 50 dBm, 50 dBm 11.14 dBm, 11.14 dBm, 11.14 dBm, 11.14 dBm, 50 dBm, 50 dBm</p> <p>ISDB-T: 50 dBm, 50 dBm, 50 dBm, 50 dBm, 50 dBm, 50 dBm 50 dBm, 50 dBm, 50 dBm, 50 dBm, 50 dBm, 50 dBm</p> <p>CMMB: 11.14 dBm, 11.14dBm, 11.14 dBm, 11.14 dBm, 50 dBm, 50 dBm 11.14 dBm, 11.14 dBm, 11.14 dBm, 11.14 dBm, 50 dBm, 50 dBm</p> <p>LTE, LTETDD, MSR, LTEAFDD, LTEATDD: -8.45, -8.45, -8.45, -8.45, -8.45, -8.45 -50.0, -50.0, -50.0, -50.0, -50.0, -50.0</p> <p>Digital Cable TV: 50 dBm, 50 dBm, 50 dBm, 50 dBm, 50 dBm, 50 dBm 50 dBm, 50 dBm, 50 dBm, 50 dBm, 50 dBm, 50 dBm</p>
State Saved	Saved in instrument state.
Min	-200.0 dBm
Max	50.0 dBm
<b>Backwards Compatibility SCPI</b>	[:SENSe]:ACPR:OFFSet[1] 2:LIST:ABSolute (PSA W-CDMA, PSA cdma2000 )
	[:SENSe]:MCPower:OFFSet[1] 2:LIST:ABSolute (PSA W-CDMA)
Initial S/W Revision	Prior to A.02.00
Modified at S/W Revision	A.02.00, A.03.00, A.13.00

### Rel Lim (Car)

Enters a relative limit value for the carrier level. This sets the amplitude levels to test against for the specified offsets.

The amplitude level is relative to the carrier amplitude. If multiple offsets are available, the list contains six (6) entries. The offset closest to the carrier channel is the first one in the list.

[:SENSe]:ACP:OFFSet[n][:OUTer]:LIST:TEST selects the type of testing to be done at each offset.

You can turn off (not use) specific offsets with the [:SENSe]:ACP:OFFSet[n][:OUTer]:LIST:STATe command.

The query returns the six (6) sets of real numbers that are the current amplitude test limits, relative to the carrier, for each offset.

Offset[n] n = 1 is base station and n = 2 is mobiles. The default is base station (1).

Key Path	Meas Setup, Offset/Limits, Limits,
----------	------------------------------------

Mode	SA, WCDMA, C2K, WIMAX OFDMA, TD-SCDMA, 1xEVDO, DVB-T/H, DTMB (CTTB), ISDB-T, CMMB, LTE, LTE-TDD, Digital Cable TV, MSR, LTEAFDD, LTEATDD
Remote Command	<code>[ :SENSe ] :ACPower:OFFSet [ 1 ]   2 [ :OUTer ] :LIST:RCARrier &lt;real&gt;, &lt;real&gt;, &lt;real&gt;, &lt;real&gt;, &lt;real&gt;</code>  <code>[ :SENSe ] :ACPower:OFFSet [ 1 ]   2 [ :OUTer ] :LIST:RCARrier?</code>
Example	ACP:OFFS2:LIST:RCAR 0,0,0,0,0 ACP:OFFS2:LIST:RCAR?
Notes	Offset sub op code. 1 for BTS, 2 for MS. Default is BTS. Note that Offset sub op code 2 is supported only in Non-SA modes. In the SA mode, Offset sub op code 1 is used for both BTS and MS. You must be in the mode that includes ACP measurements to use this command. Use :INSTrument:SElect to set the mode.
Couplings	None If current mode is DTMB (CTTB) or CMMB and current device type is Transmitter, the value from position 2 to position 4 are coupled, changing any one will change the others.
Preset	SA: -45, -60, 0, 0, 0, 0 -45, -60, 0, 0, 0, 0 WCDMA: -44.2, -49.2, -49.2, -49.2, -49.2, -49.2 -32.2, -42.2, -42.2, -42.2, -42.2, -42.2 C2K: 0, 0, 0, 0, 0, 0 0, 0, 0, 0, 0, 0 WIMAX OFDMA: -50, -60, 0, 0, 0, 0 TD-SCDMA: -40, -45, -45, -45, -45, -45 -33, -43, -43, -43, -43, -43 1xEVDO: -45, -55, -55, -55, -55, -55 -45, -55, -55, -55, -55, -55 DVB-T/H: -60, -60, 0, 0, 0, 0 -60, -60, 0, 0, 0, 0 DTMB (CTTB): -45, -60, -60, -60, 50, 50 -45, -60, -60, -60, 50, 50 ISDB-T: -60, -60, 0, 0, 0, 0 -60, -60, 0, 0, 0, 0 CMMB: -45, -60, -60, -60, 50, 50 -45, -60, -60, -60, 50, 50 LTE, LTE-TDD, MSR, LTEAFDD, LTEATDD: -44.2, -44.2, -44.2, -44.2, -44.2, -44.2 -29.2, -29.2, -29.2, -29.2, -29.2, -29.2 Digital Cable TV: -58, -62, -65, -73, -73, -73 -58, -62, -65, -73, -73, -73
State Saved	Saved in instrument state.
Min	-150
Max	50.0
Backwards Compatibility SCPI	<code>[ :SENSe ] :MCPower:OFFSet [ 1 ]   2 :LIST:RCARrier (PSA WCDMA)</code>
Initial S/W Revision	Prior to A.02.00
Modified at S/W Revision	A.02.00, A.03.00, A.04.00, A.13.00

#### Positive Offset Limit (SCPI only)

Enables you to set the upper limit for the upper segment of the specified offset pair.

Mode	SA, WCDMA, CDMA2K, WIMAXOFDMA, TDSCDMA, CDMA1XEV, DVB, DTMB, LTE, LTETDD, DCATV, MSR, LTEAFDD,LTEATDD
Remote Command	:CALCulate:ACPower:OFFSet[:OUTer]:LIST:LIMit:POSitive[:UPPer]:DATA <real>, <real>, <real>, <real>, <real>, <real>  :CALCulate:ACPower:OFFSet[:OUTer]:LIST:LIMit:POSitive[:UPPer]:DATA?
Example	CALC:ACP:OFFS:LIST:LIM:POS:DATA 0, 0, 0, 0, 0, 0 CALC:ACP:OFFS:LIST:LIM:POS:DATA?
Notes	SCPI only command
Preset	SA: -45, -60, 0, 0, 0, 0 -45, -60, 0, 0, 0, 0 WCDMA: -44.2, -49.2, -49.2, -49.2, -49.2, -49.2 -32.2, -42.2, -42.2, -42.2, -42.2, -42.2 C2K: 0, 0, 0, 0, 0, 0 0, 0, 0, 0, 0, 0 WIMAX OFDMA: -50, -60, 0, 0, 0, 0 TD-SCDMA: -40, -45, -45, -45, -45, -45 -33, -43, -43, -43, -43, -43 1xEVDO: -45, -55, -55, -55, -55, -55 -45, -55, -55, -55, -55, -55 DVB-T/H: -60, -60, 0, 0, 0, 0 -60, -60, 0, 0, 0, 0 DTMB (CTTB): -45, -60, -60, -60, 0, 0 -45, -60, -60, -60, 0, 0 Digital Cable TV: -58, -62, -65, -73, -73, -73 -58, -62, -65, -73, -73, -73 LTE, LTETDD, MSR, LTEAFDD, LTEATDD: -44.2, -44.2, -44.2, -44.2, -44.2, -44.2 -29.2, -29.2, -29.2, -29.2, -29.2, -29.2
State Saved	Saved in instrument state.
Min	-150.0
Max	50.0
Backwards Compatibility SCPI	:CALCulate:MCPower:OFFSet:LIST:LIMit:POSitive[:UPPer]:DATA (PSA Power Suite)
Initial S/W Revision	A.04.00
Modified at S/W Revision	A.13.00

### Negative Offset Limit

Enables you to set the upper limit for the lower segment of the specified offset pair.

Mode	SA, WCDMA, CDMA2K, WIMAXOFDMA, TDSCDMA, CDMA1XEV, DVB, DTMB, LTE, LTETDD, DCATV, MSR, LTEAFDD,LTEATDD
Remote Command	:CALCulate:ACPower:OFFSet[:OUTer]:LIST:LIMit:NEGative[:UPPer]:DATA <real>, <real>, <real>, <real>, <real>, <real>  :CALCulate:ACPower:OFFSet[:OUTer]:LIST:LIMit:NEGative[:UPPer]:DATA?
Example	CALC:ACP:OFFS:LIST:LIM:NEG:DATA 0, 0, 0, 0, 0, 0 CALC:ACP:OFFS:LIST:LIM:NEG:DATA?
Notes	SCPI only command
Preset	SA: -45, -60, 0, 0, 0, 0 -45, -60, 0, 0, 0, 0 WCDMA: -44.2, -49.2, -49.2, -49.2, -49.2, -49.2 -32.2, -42.2, -42.2, -42.2, -42.2, -42.2

	C2K: 0, 0, 0, 0, 0, 0 0, 0, 0, 0, 0, 0 WIMAX OFDMA: -50, -60, 0, 0, 0, 0 TD-SCDMA: -40, -45, -45, -45, -45, -45 -33, -43, -43, -43, -43, -43 1xEVDO: -45, -55, -55, -55, -55, -55 -45, -55, -55, -55, -55, -55 DVB-T/H: -60, -60, 0, 0, 0, 0 -60, -60, 0, 0, 0, 0 DTMB (CTTB): -45, -60, -60, -60, 0, 0 -45, -60, -60, -60, 0, 0 Digital Cable TV: -58, -62, -65, -73, -73, -73 -58, -62, -65, -73, -73, -73 LTE, LTEFDD, MSR, LTEAFDD, LTEATDD: -44.2, -44.2, -44.2, -44.2, -44.2, -44.2 -29.2, -29.2, -29.2, -29.2, -29.2, -29.2
State Saved	Saved in instrument state.
Min	-150.0
Max	50.0
<b>Backwards Compatibility SCPI</b>	:CALCulate:MCPower:OFFSet:LIST:LIMit:NEGative[:UPPer]:DATA (PSA Power Suite)
Initial S/W Revision	A.04.00
Modified at S/W Revision	A.13.00

## Rel Limit (PSD)

Enters a relative limit value for the level of the power spectral density. This sets the amplitude levels to test against for any custom offsets. The amplitude level is relative to the power spectral density. If multiple offsets are available, the list contains six (6) entries. The offset closest to the carrier channel is the first one in the list.

`[:SENSe]:ACP:OFFSet[n][:OUTer]:LIST:TEST` selects the type of testing to be done at each offset.

You can turn off (not use) specific offsets with the `[:SENSe]:ACP:OFFSet[n][:OUTer]:LIST:STATe` command.

The query returns the six (6) sets of real numbers that are the current amplitude test limits, relative to the power spectral density, for each offset.

Offset[n] n = 1 is base station and n = 2 is mobiles. The default is base station (1).

Key Path	Meas Setup, Offset/Limits, Limits
Mode	SA, WCDMA, C2K, WIMAX OFDMA, TD-SCDMA, 1xEVDO, DVB-T/H, DTMB (CTTB), ISDB-T, CMMB, LTE, LTEFDD, Digital Cable TV, MSR, LTEAFDD, LTEATDD
Remote Command	<code>[:SENSe]:ACP:OFFSet[1] 2[:OUTer]:LIST:RPSDensity &lt;rel_ampl&gt;, &lt;rel_ampl&gt;, &lt;rel_ampl&gt;, &lt;rel_ampl&gt;, &lt;rel_ampl&gt;</code> <code>[:SENSe]:ACP:OFFSet[1] 2[:OUTer]:LIST:RPSDensity?</code>
Example	<code>ACP:OFFS2:LIST:RPSD 10,10,10,10,10,10</code> <code>ACP:OFFS2:LIST:RPSD?</code>
Notes	Offset sub op code. 1 for BTS, 2 for MS. Default is BTS. Note that Offset sub op code 2 is supported only in Non-SA modes. In the SA mode, Offset sub op code 1 is used for both BTS and MS.

	You must be in the mode that includes ACP measurements to use this command. Use :INSTrument:SElect to set the mode.
Preset	SA: -28.87 dB, -43.87 dB, 0 dB, 0 dB, 0 dB, 0 dB -28.87 dB, -43.87 dB, 0 dB, 0 dB, 0 dB, 0 dB WCDMA: -44.2 dB, -49.2 dB, -49.2 dB, -49.2 dB, -49.2 dB, -49.2 dB -32.2 dB, -42.2 dB, -42.2 dB, -42.2 dB C2K: 0 dB, 0 dB, 0 dB, 0 dB, 0 dB, 0 dB 0 dB, 0 dB, 0 dB, 0 dB, 0 dB, 0 dB WIMAX OFDMA: -25,-35,0,0,0,0 TD-SCDMA: -40 dB, -45 dB, -45 dB, -45 dB, -45 dB, -45 dB -33 dB, -43 dB, -43 dB, -43 dB, -43 dB, -43 dB 1xEVDO: -45, -55, -55, -55, -55, -55 -45, -55, -55, -55, -55, -55 DVB-T/H: -60 dB, -60 dB, 0 dB, 0 dB, 0 dB, 0 dB -60 dB, -60 dB, 0 dB, 0 dB, 0 dB, 0 dB DTMB (CTTB): 50 dB, 50 dB, 50 dB, 50 dB, 50 dB, 50 dB 50 dB, 50 dB, 50 dB, 50 dB, 50 dB, 50 dB ISDB-T: -60 dB, -60 dB, 0 dB, 0 dB, 0 dB, 0 dB -60 dB, -60 dB, 0 dB, 0 dB, 0 dB, 0 dB CMMB: 50 dB, 50 dB, 50 dB, 50 dB, 50 dB, 50 dB 50 dB, 50 dB, 50 dB, 50 dB, 50 dB, 50 dB LTE, LTE TDD, MSR, LTE AFDD, LTE ATDD: 0, 0, 0, 0, 0, 0 0, 0, 0, 0, 0, 0 Digital Cable TV: 50 dB, 50 dB, 50 dB, 50 dB, 50 dB, 50 dB 50 dB, 50 dB, 50 dB, 50 dB, 50 dB, 50 dB
State Saved	Saved in instrument state.
Min	-150.0 dB
Max	50.0 dB
Initial S/W Revision	Prior to A.02.00
Modified at S/W Revision	A.02.00, A.03.00, A.13.00

## Fail Mask

Accesses a menu that enables you to select one of the logic keys for the fail conditions between the measurement results and the test limits. The setting defines the type of testing to be done at any custom offset frequencies. The measured powers are tested against the absolute values defined with [:SENSE]:ACP:OFFSet[n][:OUTer]:LIST:ABSolute, or the relative values defined with [:SENSE]:ACP:OFFSet[n][:OUTer]:LIST:RPSDensity and [:SENSE]:ACP:OFFSet[n][:OUTer]:LIST:RCARrier.

You can turn off (not use) specific offsets with the [:SENSE]:ACP:OFFSet[n][:OUTer]:LIST:STATe command.

- Absolute – Fail is shown if one of the absolute ACP measurement results is larger than the limit for Abs Limit.
- Relative – Fail is shown if one of the relative ACP measurement results is larger than the limit for Rel Lim (Car) or Rel Lim (PSD).
- Abs AND Rel – Fail is shown if one of the absolute ACP measurement results is larger than the limit for Abs Limit AND one of the relative ACP measurement results is larger than the limit for Rel Lim (Car) or Rel Lim (PSD).

- Abs OR Rel– Fail is shown if one of the absolute ACP measurement results is larger than the limit for Abs Limit OR one of the relative ACP measurement results is larger than the limit for Rel Lim (Car) or Rel Lim (PSD).

Key Path	Meas Setup, Offset/Limits, Limits
Mode	SA, WCDMA, C2K, WIMAX OFDMA, TD-SCDMA, 1xEVDO, DVB-T/H, DTMB (CTTB), ISDB-T, CMMB, LTE, LTETDD, Digital Cable TV, MSR, LTEAFDD, LTEATDD
Remote Command	[:SENSe]:ACPower:OFFSet[1] 2[:OUTer]:LIST:TEST ABSolute   AND   OR   RELative, ABSolute   AND   OR   RELative, ABSolute   AND   OR   RELative, ABSolute   AND   OR   RELative, ABSolute   AND   OR   RELative [:SENSe]:ACPower:OFFSet[1] 2[:OUTer]:LIST:TEST?
Example	ACP:OFFS2:LIST:TEST ABS, ABS, ABS, ABS, ABS, ABS ACP:OFFS2:LIST:TEST?
Notes	Offset sub op code. 1 for BTS, 2 for MS. Default is BTS. Note that Offset sub op code 2 is supported only in Non-SA modes. In the SA mode, Offset sub op code 1 is used for both BTS and MS. You must be in the mode that includes ACP measurements to use this command. Use :INSTrument:SElect to set the mode.
Couplings	None If current mode is DTMB (CTTB) or CMMB and current device type is Transmitter, the value from position 2 to position 4 are coupled, changing any one will change the others.
Preset	SA, WCDMA, C2K, TD-SCDMA: REL, REL, REL, REL, REL, REL REL, REL, REL, REL, REL, REL WIMAX OFDMA: REL, REL, REL, REL, REL, REL DVB-T/H: REL, REL, REL, REL, REL, REL DTMB (CTTB): OR,AND, AND,AND, REL, REL CDMA1xEVDO: REL, REL, ABS, REL, REL, REL REL, REL, ABS, REL, REL, REL ISDB-T: REL, REL, REL, REL, REL, REL CMMB: OR,AND, AND,AND, REL, REL LTE, LTETDD, MSR, LTEAFDD, LTEATDD: AND, AND, AND, AND, AND, AND AND, AND, AND, AND, AND, AND Digital Cable TV: REL, REL, REL, REL, REL, REL
State Saved	Saved in instrument state.
Range	Absolute Relative Abs AND Rel (fail if both fail) Abs OR Rel (fail if either fails)
Backwards Compatibility SCPI	[:SENSe]:MCPower:OFFSet[1] 2:LIST:TEST
Initial S/W Revision	Prior to A.02.00
Modified at S/W Revision	A.02.00, A.03.00, A.04.00, A13.00

## Offset Side

Enables you to turn off (not use) specific offsetswith [:SENSe]:ACPower:OFFSet[1]|2[:Outer]:LIST:SIDE.

- NEGative - Negative (lower) sideband only

- BOTH - Both of the negative (lower) and positive (upper) sidebands
- POSitive - Positive (upper) sideband only

The figure below shows the relation between the negative/positive offset side setups and the upper/lower results in the MSR and LTE-Advanced FDD/TDD.

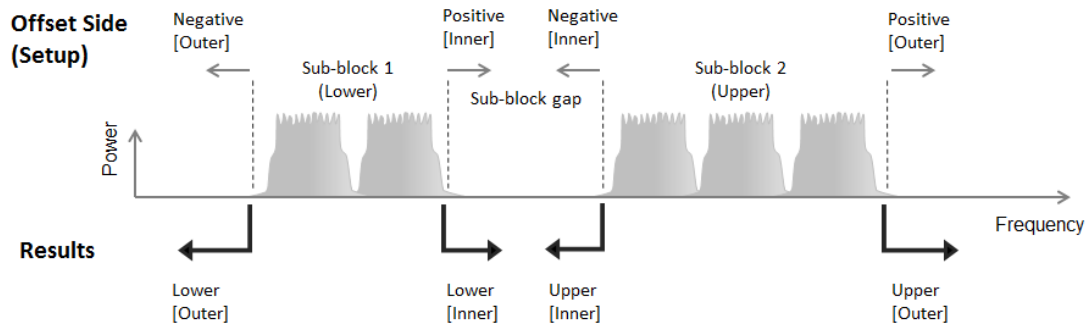

Key Path	Meas Setup, Offset/Limits
Mode	SA, WCDMA, C2K, WIMAX OFDMA, TD-SCDMA, 1xEVDO, DTMB (CTTB), DVB-T/H, LTE, LTEFDD, Digital Cable TV, MSR, LTEAFDD, LTEATDD
Remote Command	<code>[[:SENSE]:ACPower:OFFSet [1]   2 [:OUTer]:LIST:SIDE NEGative   BOTH   POSitive,NEGative   BOTH   POSitive,NEGative   BOTH   POSitive,NEGative   BOTH   POSitive,NEGative   BOTH   POSitive</code> <code>[[:SENSE]:ACPower:OFFSet [1]   2 [:OUTer]:LIST:SIDE?</code>
Example	ACP:OFFS:LIST:SIDE BOTH ACP:OFFS:LIST:SIDE?
Notes	OFFSet1 is for BTS, 2 for MS. Default is BTS. You must be in the Spectrum Analysis mode, W-CDMA mode, cdma2000 mode, TD-SCDMA mode, DTMB (CTTB) mode, DVB-T/H mode, ISDB-T mode, CMMB mode, Digital Cable TV mode, 1xEVDO mode, WIMAX OFDMA mode, LTE mode, LTEFDD, LTEATDD or MSR mode to use this command. Use :INSTRument:SElect to set the mode. If you set POS or NEG in an offset, result of the inactive side will return -999.
Preset	BOTH, BOTH, BOTH, BOTH, BOTH, BOTH BOTH, BOTH, BOTH, BOTH, BOTH, BOTH
State Saved	Saved in instrument state.
Range	Neg Both Pos
Initial S/W Revision	A.03.00
Modified at S/W Revision	A.13.00

### Method for Offset

This key allows you to turn RRC filtering of each offset on or off. The value (roll off) for the filter will be set to the value of the Filter Alpha parameter.

Key Path	Meas Setup, Offset/Limits
----------	---------------------------



Mode	SA, WCDMA, WIMAX OFDMA, TD-SCDMA, DVB-T/H, DTMB (CTTB), ISDB-T, CMMB, LTE, LTETDD, Digital Cable TV, MSR, LTEAFDD, LTEATDD
Remote Command	[ :SENSe ] :ACPower:OFFSet [ 1 ]   2 [ :OUTer ] :LIST:FILTer [ :RRC ] [ :STATe ] ON   OFF   1   0, ON   OFF   1   0, ON   OFF   1   0, ON   OFF   1   0, ON   OFF   1   0, ON   OFF   1   0  [ :SENSe ] :ACPower:OFFSet [ 1 ]   2 [ :OUTer ] :LIST:FILTer [ :RRC ] [ :STATe ] ?
Example	ACP:OFFS:LIST:FILT 1,0,0 ACP:OFFS:LIST:FILT?
Notes	1 ON = RRC Weighted, 0 OFF = Integ BW This parameter is not available for cdma2000 and 1xEVDO. You must be in the mode that includes ACP measurements to use this command. Use :INSTrument:SElect to set the mode.
Preset	SA: 0, 0, 0, 0, 0, 0 0, 0, 0, 0, 0, 0 WCDMA:1, 1, 1, 1, 1, 1 1, 1, 1, 1, 1, 1 C2K: NO WIMAX OFDMA: 0, 0, 0, 0, 0, 0 0, 0, 0, 0, 0, 0 TD-SCDMA: 1, 1, 1, 1, 1, 1 1, 1, 1, 1, 1, 1 DVB-T/H: 0, 0, 0, 0, 0, 0 0, 0, 0, 0, 0, 0 DTMB (CTTB): 1, 1, 1, 1, 1, 1 1, 1, 1, 1, 1, 1 ISDB-T: 0, 0, 0, 0, 0, 0 0, 0, 0, 0, 0, 0 CMMB: 1, 1, 1, 1, 1, 1 1, 1, 1, 1, 1, 1 LTE: 0, 0, 0, 0, 0, 0 0, 0, 0, 0, 0, 0 LTETDD: 0, 0, 0, 0, 0, 0 0, 0, 0, 0, 0, 0 Digital Cable TV: 0, 0, 0, 0, 0, 0 0, 0, 0, 0, 0, 0 MSR, LTEAFDD, LTEATDD: 0, 0, 0, 0, 0, 0 0, 0, 0, 0, 0, 0
State Saved	Saved in instrument state.
Range	Integ BW RRC Weighted
Initial S/W Revision	A.03.00
Modified at S/W Revision	A.13.00

### Method for Offset

This key allows you to turn RRC filtering of each offset on or off. The value (roll off) for the filter will be set to the value of the Filter Alpha parameter.

Key Path	Meas Setup, Offset/Limits
Mode	SA, WCDMA, WIMAX OFDMA, TD-SCDMA, DVB-T/H, DTMB (CTTB), ISDB-T, CMMB, LTE, LTETDD, Digital Cable TV, MSR, LTEAFDD, LTEATDD
Remote Command	[ :SENSe ] :ACPower:OFFSet [ 1 ]   2 [ :OUTer ] :LIST:FILTer [ :RRC ] [ :STATe ] ON   OFF   1   0, ON   OFF   1   0, ON   OFF   1   0, ON   OFF   1   0, ON   OFF   1   0, ON   OFF   1   0  [ :SENSe ] :ACPower:OFFSet [ 1 ]   2 [ :OUTer ] :LIST:FILTer [ :RRC ] [ :STATe ] ?

<b>Example</b>	ACP:OFFS:LIST:FILT 1,0,0 ACP:OFFS:LIST:FILT?
<b>Notes</b>	1 ON = RRC Weighted, 0 OFF = Integ BW This parameter is not available for cdma2000 and 1xEVDO. You must be in the mode that includes ACP measurements to use this command. Use :INSTrument:SElect to set the mode.
<b>Preset</b>	SA: 0, 0, 0, 0, 0, 0 0, 0, 0, 0, 0, 0 WCDMA:1, 1, 1, 1, 1, 1 1, 1, 1, 1, 1, 1 C2K: NO WIMAX OFDMA: 0, 0, 0, 0, 0, 0 0, 0, 0, 0, 0, 0 TD-SCDMA: 1, 1, 1, 1, 1, 1 1, 1, 1, 1, 1, 1 DVB-T/H: 0, 0, 0, 0, 0, 0 0, 0, 0, 0, 0, 0 DTMB (CTTB): 1, 1, 1, 1, 1, 1 1, 1, 1, 1, 1, 1 ISDB-T: 0, 0, 0, 0, 0, 0 0, 0, 0, 0, 0, 0 CMMB: 1, 1, 1, 1, 1, 1 1, 1, 1, 1, 1, 1 LTE: 0, 0, 0, 0, 0, 0 0, 0, 0, 0, 0, 0 LTETDD: 0, 0, 0, 0, 0, 0 0, 0, 0, 0, 0, 0 Digital Cable TV: 0, 0, 0, 0, 0, 0 0, 0, 0, 0, 0, 0 MSR, LTEAFDD, LTEATDD: 0, 0, 0, 0, 0, 0 0, 0, 0, 0, 0, 0
<b>State Saved</b>	Saved in instrument state.
<b>Range</b>	Integ BW RRC Weighted
<b>Initial S/W Revision</b>	A.03.00
<b>Modified at S/W Revision</b>	A.13.00

### Filter Alpha for Offset

Sets the alpha value for the RRC Filter for each offset.

<b>Key Path</b>	Meas Setup, Offset/Limits, Method, RRC Weighted
<b>Mode</b>	SA, WCDMA, WIMAX OFDMA, TD-SCDMA, DVB-T/H, DTMB (CTTB), ISDB-T, CMMB, LTE, LTETDD, Digital Cable TV, MSR, LTEAFDD, LTEATDD
<b>Remote Command</b>	[ :SENSe ] :ACPpower:OFFSet [ 1 ]   2 [ :OUTer ] :LIST:FILTER:ALPHa <real>, <real>, <real>, <real>, <real> [ :SENSe ] :ACPpower:OFFSet [ 1 ]   2 [ :OUTer ] :LIST:FILTER:ALPHa?
<b>Example</b>	ACP:OFFS:LIST:FILT:ALPH 0.5, 0.5, 0.5, 0.5, 0.5, 0.5 ACP:OFFS:LIST:FILT:ALPH?
<b>Notes</b>	This parameter is not available for cdma2000 and 1xEVDO. You must be in the mode that includes ACP measurements to use this command. Use :INSTrument:SElect to set the mode.
<b>Preset</b>	SA: 0.22, 0.22, 0.22, 0.22, 0.22, 0.22 0.22, 0.22, 0.22, 0.22, 0.22, 0.22 WCDMA: 0.22, 0.22, 0.22, 0.22, 0.22, 0.22 0.22, 0.22, 0.22, 0.22, 0.22, 0.22

	WIMAX OFDMA: 0.22, 0.22, 0.22, 0.22, 0.22, 0.22 0.22, 0.22, 0.22, 0.22, 0.22, 0.22
	C2K: NO
	TD-SCDMA: 0.22, 0.22, 0.22, 0.22, 0.22, 0.22 0.22, 0.22, 0.22, 0.22, 0.22, 0.22
	DVB-T/H: 0.22, 0.22, 0.22, 0.22, 0.22, 0.22 0.22, 0.22, 0.22, 0.22, 0.22, 0.22
	DTMB (CTTB): 0.05, 0.05, 0.05, 0.05, 0.05, 0.05 0.05, 0.05, 0.05, 0.05, 0.05, 0.05
	ISDB-T : 0.22, 0.22, 0.22, 0.22, 0.22, 0.22 0.22, 0.22, 0.22, 0.22, 0.22, 0.22
	CMMB : 0.22, 0.22, 0.22, 0.22, 0.22, 0.22 0.22, 0.22, 0.22, 0.22, 0.22, 0.22
	LTE: 0.22, 0.22, 0.22, 0.22, 0.22, 0.22 0.22, 0.22, 0.22, 0.22, 0.22, 0.22
	LTETDD: 0.22, 0.22, 0.22, 0.22, 0.22, 0.22 0.22, 0.22, 0.22, 0.22, 0.22, 0.22
	Digital Cable TV: 0.15, 0.15, 0.15, 0.15, 0.15, 0.15 0.15, 0.15, 0.15, 0.15, 0.15, 0.15
	MSR, LTEAFDD, LTEATDD: 0.22, 0.22, 0.22, 0.22, 0.22, 0.22 0.22, 0.22, 0.22, 0.22, 0.22, 0.22
State Saved	Saved in instrument state.
Min	0.01
Max	1.00
Initial S/W Revision	A.03.00
Modified at S/W Revision	A.13.00

## Offset Frequency Define

This key allows you to select “Offset” definition. Each standard defines each “Offset” from Carrier.

3GPP2 requires the “From Carrier Center to MeasBW Closer Edge” definition. LTE conformance test requires “From Carrier Edge to MeasBW Center” and/or “From Carrier Edge to MeasBW Closer Edge” definition.

- CTOCenter – From the center of the carrier closest to the adjacent channel to the center of the adjacent channel Offset Integ BW
- CTOEdge – From the center of the carrier closest to the adjacent channel to the edge of the closest adjacent channel Offset Integ BW
- ETOCenter – From Center Frequency - Carrier Spacing / 2 (for lower offset), Center Frequency + Carrier Spacing / 2 (for upper offset) of the carrier closest to the adjacent channel's to the center of the adjacent channel Offset Integ BW
- ETOEdge – From Center Frequency - Carrier Spacing / 2 (for lower offset), Center Frequency + Carrier Spacing / 2 (for upper offset) of the carrier closest to the adjacent channel's to the edge of the closest adjacent channel Offset Integ BW

Key Path	Meas Setup, Offset/Limits
Mode	SA, WCDMA, C2K, WIMAX OFDMA, TD-SCDMA, 1xEVDO, DVB-T/H, DTMB (CTTB), ISDB-T, CMMB, LTE, LTETDD, Digital Cable TV, MSR,LTEAFDD,LTEATDD
Remote Command	[ :SENSe ] :ACPower:OFFSet [1]   2 [ :OUTer ] :TYPE CTOCenter   CTOEdge   ETOCenter   ETOEdge [ :SENSe ] :ACPower:OFFSet [1]   2 [ :OUTer ] :TYPE?

<b>Example</b>	ACP:OFFS:TYPE ETOC ACP:OFFS:TYPE?
<b>Notes</b>	You must be in the mode that includes ACP measurements to use this command. Use :INSTrument:SElect to set the mode.
<b>Preset</b>	All Except C2K and 1xEVDO: CTOCenter C2K and 1xEVDO: CTOEdge
<b>State Saved</b>	Saved in instrument state.
<b>Range</b>	Carrier Center To Meas BW Center Carrier Center To Meas BW Edge Carrier Edge To Meas BW Center Carrier Edge To Meas BW Edge
<b>Initial S/W Revision</b>	A.03.00
<b>Modified at S/W Revision</b>	A.13.00

## Carrier Result

Allows you to view and scroll through the carrier power results.

<b>Key Path</b>	Meas Setup
<b>Mode</b>	SA, WCDMA, C2K, WIMAX OFDMA, TD-SCDMA, 1xEVDO, DVB-T/H, DTMB (CTTB), ISDB-T, CMMB, LTE, LTE-TDD, Digital Cable TV, MSR, LTEAFDD, LTEATDD
<b>Couplings</b>	This key will be grayed out if there is only one carrier.
<b>Preset</b>	1
<b>State Saved</b>	No
<b>Min</b>	1
<b>Max</b>	Number of carriers.
<b>Initial S/W Revision</b>	Prior to A.02.00
<b>Modified at S/W Revision</b>	A.02.00, A.03.00

## Meas Method

Sets the desired method to measure ACP.

Integration BW – one sweep of the trace is taken, and the band power for each offset is computed. Depending on the status of the Meas Type parameter (Total Power Reference or PSD Reference), results are displayed relative to the total power or the power spectral density. The display reflects either the current trace or a bar graph view.

Filtered IBW (max dynamic range) – the ACP Path is used to compute ACP when an ACP path is available. This method increases dynamic range, but increases measurement time as it limits the resolution bandwidth. This method is useful for improving dynamic range on a W-CDMA signal because a sharp cutoff bandpass filter is used. The accuracy of the adjacent channel power ratio is not degraded by this method, but the absolute accuracy of both adjacent channel power and carrier power are degraded by up to about 0.5 dB.

RBW – the algorithm uses zero-span and an appropriate RBW setting to capture all of the power in the carrier channel and the offsets. The zero-span algorithm (RBW method) is slower than the IBW method, but greatly improves repeatability.

Fast (in WCDMA mode or SA mode with 3GPP WCDMA radio standard selected) – this provides the same method as the Integration BW method, but is optimized for speed to measure a W-CDMA signal.

Fast (in CDMA2K mode or SA mode with CDMA2K radio standard selected) – this provides faster measurement using the FFT method with a limited parameter flexibility. When this is selected, CDMA2K preset offsets are given and control of the following are grayed out:

BW menu, Sweep/Control menu except Pause/Resume, Trace/Detector menu, Carrier Setup, Offset Limit, RRC Weighting, Filter Alpha, and Noise Correction softkeys in Meas Setup menu.

Key Path	Meas Setup
Mode	SA, WCDMA, C2K, WIMAX OFDMA, 1xEVDO, DVB-T/H, DTMB (CTTB), ISDB-T, CMMB, LTE, LTETDD, Digital Cable TV, MSR,, LTEAFDD, LTEATDD
Remote Command	[ :SENSe] :ACPoweR:METhod IBW IBWRange FAST RBW [ :SENSe] :ACPoweR:METhod?
Example	ACP:METh IBW ACP:METh?
Notes	<p>FAST mode is only supported for WCDMA and C2K signal. You must be in the WCDMA or C2K mode or SA mode with 3GPP WCDMA or CDMA2K radio standard. Otherwise a setting conflict error message will be reported.</p> <p>In the TDSCDMA mode, only the IBW method is available to use. Therefore, the measure method key is not displayed in the TD-SCDMA mode.</p> <p>CDMA1xEVDO mode only supports RBW and Integration BW method.</p> <p>C2K mode only supports RBW, Integration BW and FAST method.</p> <p>LTETDD mode only supports Integration BW and Filtered IBW method.</p> <p>MSR mode only supports Integration BW and Filtered IBW method.</p> <p>LTE-Advanced FDD/TDD mode only support IBW and Filtered IBW method.</p> <p>You must be in the mode that includes ACP measurements to use this command. Use :INSTrument:SElect to set the mode.</p>
Dependencies	<p>When RBW or FAST is selected, Gate function is not available. If you try to turn Gate On while Meas Method is RBW or FAST, an error is generated.</p> <p>When Gate function is ON, RBW and FAST method is not available. If you try to change Meas Method to RBW or FAST, an error is generated.</p>
Couplings	IBW (Range) restricts the Res BW available for making this measurement to 30 kHz. When selected, the Res BW is clipped to this value if required and an error number displayed.
Preset	SA, LTE, LTETDD, MSR, LTEAFDD, LTEATDD: IBW WCDMA: IBW C2K: RBW WIMAX OFDMA: IBW 1xEVDO: IBW DVB-T/H: IBW

	DTMB (CTTB): IBW ISDB-T: IBW CMMB: IBW Digital Cable TV: IBW
State Saved	Saved in instrument state.
Range	Integration BW Filtered IBW (max dynamic range) RBW Fast
Readback Text	IBW Filtered IBW RBW Fast
<b>Backwards Compatibility SCPI</b>	[ :SENSe ] :ACPR :SWEep :TYPE [ :SENSe ] :MCPower :METHod (PSA Power Suite)
Initial S/W Revision	Prior to A.02.00
Modified at S/W Revision	A.02.00, A.03.00

## Meas Type

Changes the reference used for the measurement. This allows you to make absolute and relative power measurements of either total power or the power normalized to the measurement bandwidth.

Total Pwr Ref (TPR) sets the reference to the total carrier power. PSD Ref (PSDR) sets the reference to the power spectral density of the carrier.

Key Path	Meas Setup
Mode	SA, WCDMA, C2K, WIMAX OFDMA, TD-SCDMA, 1xEVDO, DVB-T/H, DTMB (CTTB), ISDB-T, CMMB, LTE, LTEFDD, Digital Cable TV, MSR, LTEAFDD, LTEATDD
<b>Remote Command</b>	[ :SENSe ] :ACPpower :TYPE TPRef   PSDRef [ :SENSe ] :ACPpower :TYPE?
<b>Example</b>	ACP:TYPE PSDR ACP:TYPE?
Notes	You must be in the mode that includes ACP measurements to use this command. Use :INSTRument:SElect to set the mode.
Preset	TPRef
State Saved	Saved in instrument state.
Range	Total Power Ref PSD Ref
Initial S/W Revision	Prior to A.02.00
Modified at S/W Revision	A.02.00, A.03.00

## PSD Ref

Sets the unit bandwidth for Power Spectral Density. The available units are dBm/Hz and dBm/MHz.

Key Path	Meas Setup
----------	------------

Mode	A, WCDMA, C2K, WIMAX OFDMA, TD-SCDMA, 1xEVDO, DVB-T/H, DTMB (CTTB), ISDB-T, CMMB, LTE, LTETDD, Digital Cable TV, MSR, LTEAFDD, LTEATDD
<b>Remote Command</b>	:UNIT:ACPower:POWer:PSD DBMHZ   DBMMHZ :UNIT:ACPower:POWer:PSD?
<b>Example</b>	UNIT:ACP:POW:PSD DBMMHZ UNIT:ACP:POW:PSD?
Couplings	When the PSD unit is changed, the PSD reference result of the “MEAS READ FETCH:ACP[n]?” is also changed by the PSD unit basis (in either dBm/Hz or dBm/MHz).
Preset	DBMHZ
State Saved	Saved in instrument state.
Range	dBm/Hz dBm/MHz
Initial S/W Revision	Prior to A.02.00
Modified at S/W Revision	A.02.00, A.03.00

## Limit Test

Turns limit checking for each offset On or Off. The limits may be specified within the Offset menu, for each offset, both sides of the carrier. For results that fail the limit, a red F is appended. In the Combined view, the bar turns red.

Key Path	Meas Setup
Mode	SA, WCDMA, C2K, WIMAX OFDMA, TD-SCDMA, 1xEVDO, DVB-T/H, DTMB (CTTB), ISDB-T, CMMB, LTE, LTETDD, Digital Cable TV, MSR, LTEAFDD, LTEATDD
<b>Remote Command</b>	:CALCulate:ACPower:LIMit:STATe OFF ON 0 1 :CALCulate:ACPower:LIMit:STATe?
<b>Example</b>	CALC:ACP:LIM:STAT OFF CALC:ACP:LIM:STAT?
Notes	You must be in the mode that includes ACP measurements to use this command. Use :INSTrument:SElect to set the mode.
Preset	SA: OFF WCDMA: ON C2K: ON WIMAX OFDMA: OFF TD-SCDMA: ON 1xEVDO: ON DVB-T/H: OFF DTMB (CTTB): ON ISDB-T: OFF CMMB: ON LTE, LTETDD, MSR, LTEAFDD, LTEATDD: ON

	Digital Cable TV: OFF
State Saved	Saved in instrument state.
Range	On Off
<b>Backwards Compatibility SCPI</b>	<code>[ :SENSe ] :MCPower:LIMit [ :STATe ]</code>
	<code>[ :SENSe ] :ACPpower:LIMit [ :STATe ]</code>
Initial S/W Revision	Prior to A.02.00
Modified at S/W Revision	A.02.00, A.03.00

## Meas Preset

Restores all the measurement parameters to their default values.

Key Path	Meas Setup
Mode	SA, WCDMA, C2K, WIMAX OFDMA, TD-SCDMA, 1xEVDO, DVB-T/H, DTMB (CTTB), ISDB-T, CMMB, LTE, LTEFDD, Digital Cable TV, MSR, LTEAFDD, LTEATDD
<b>Remote Command</b>	<code>:CONFigure:ACPpower</code>
<b>Example</b>	CONF:ACP
Notes	You must be in the mode that includes ACP measurements to use this command. Use <code>:INSTrument:SElect</code> to set the mode.
Couplings	Selecting Meas Preset will restore all measurement parameters to their default values.
Initial S/W Revision	Prior to A.02.00
Modified at S/W Revision	A.02.00, A.03.00

## Offset RRC Weighting (Backward Compatibility SCPI)

Mode	SA, WCDMA, TD-SCDMA, WIMAX OFDMA, DVB-T/H, DTMB (CTTB), ISDB-T, CMMB, LTE, LTEFDD, Digital Cable TV, MSR, LTEAFDD, LTEATDD
<b>Remote Command</b>	<code>[ :SENSe ] :ACPpower:FILTer [ :RRC ] [ :STATe ] OFF ON 0 1</code> <code>[ :SENSe ] :ACPpower:FILTer [ :RRC ] [ :STATe ] ?</code>
<b>Example</b>	ACP:FILT OFF ACP:FILT?
Notes	This parameter is not available for cdma2000 and 1xEVDO The backwards Compatibility SCPI command, <code>[ :SENSe ] :ACPpower:FILTer [ :RRC ] [ :STATe ]</code> , is provided to support same functionality as <code>[ :SENSe ] :ACPpower:FILTer [ :RRC ] [ :STATe ]</code> (PSA W-CDMA, PSA cdma2000 and PSA 1xEVDO) due to ACPp node conflicts with ACPpower node. You must be in the mode that includes ACP measurements to use this command. Use <code>:INSTrument:SElect</code> to set the mode.
Couplings	This command is an alias to <code>[ :SENSe ] :ACPpower:OFFSet [ 1 ] 2 :LIST:FILTer [ :RRC ] [ :STATe ]</code>



Sending the commands to set values of all offsets for BS and MS, however, sending the query always return a value of BS Offset A.

Preset	SA, WIMAX OFDMA, LTE, LTETDD, MSR: OFF WCDMA: ON C2K: NO TD-SCDMA: ON DVB-T/H: OFF DTMB (CTTB):ON ISDB-T: OFF CMMB: OFF Digital Cable TV: ON LTEAFDD,LTEATDD: OFF
State Saved	Saved in instrument state.
<b>Backwards Compatibility SCPI</b>	<code>[ :SENSe ] :ACPR:FiLTeR [ :RRC ] [ :STATe ]</code> <code>[ :SENSe ] :MCPower:FiLTeR [ :RRC ] [ :STATe ]</code>
Initial S/W Revision	Prior to A.02.00
Modified at S/W Revision	A.03.00

### Offset Filter Alpha (Backward Compatibility SCPI)

Mode	SA, WCDMA, WIMAX OFDMA, TD-SCDMA, DVB-T/H, DTMB (CTTB), ISDB-T, CMMB, LTE, LTETDD, Digital Cable TV, MSR, LTEAFDD,LTEATDD
<b>Remote Command</b>	<code>[ :SENSe ] :ACPpower:FiLTeR [ :RRC ] :ALPHa &lt;real&gt;</code> <code>[ :SENSe ] :ACPpower:FiLTeR [ :RRC ] :ALPHa?</code>
<b>Example</b>	ACP:FILT:ALPH 0.5 ACP:FILT:ALPH?
Notes	This parameter is not available for cdma2000 and 1xEVDO The backwards Compatibility SCPI command, <code>[ :SENSe ] :ACPpower:FiLTeR [ :RRC ] :ALPHa</code> , is provided to support same functionality as <code>[ :SENSe ] :ACPpower:FiLTeR [ :RRC ] :ALPHa</code> (PSA W-CDMA, PSA cdma2000 and PSA 1xEVDO) due to ACPpower node conflicts with ACPpower node. You must be in the mode that includes ACP measurements to use this command. Use <code>:INSTrument:SElect</code> to set the mode.
Couplings	This command is an alias to <code>[ :SENSe ] :ACPpower:OFFSet[1]2:LIST:FiLTeR:ALPHa</code> Sending the commands to set values of all offsets for BS and MS, however, sending the query always return a value of BS Offset A.
Preset	SA, WCDMA, WIMAX OFDMA, TD-SCDMA, DVB-T/H, ISDB-T, CMMB, LTE, LTETDD, MSR: 0.22 C2K: NO DTMB (CTTB): 0.05

	Digital Cable TV: 0.15 LTEAFDD,LTEATDD: 0.22
State Saved	Saved in instrument state.
Min	0.01
Max	1.00
<b>Backwards Compatibility SCPI</b>	[ :SENSe ] :ACPR:FILTer [ :RRC ] :ALPHa [ :SENSe ] :MCPower:FILTer [ :RRC ] :ALPHa
Initial S/W Revision	Prior to A.02.00
Modified at S/W Revision	A.03.00

### Method for Carrier (Backward Compatibility SCPI)

Mode	SA, WCDMA, WIMAX OFDMA, TD-SCDMA, DVB-T/H, DTMB (CTTB), ISDB-T, CMMB, LTE, LTETDD, Digital Cable TV, MSR
<b>Remote Command</b>	[ :SENSe ] :ACPower:CARRier [ 1 ]   2 :LIST:METhod IBW RRC, ... [ :SENSe ] :ACPower:CARRier [ 1 ]   2 :LIST:METhod?
<b>Example</b>	ACP:CARR2:LIST:METH RRC ACP:CARR2:LIST:METH?
Notes	You must be in the mode that includes ACP measurements to use this command. Use :INSTrument:SElect to set the mode. Maximum of Array length depends on the number of carriers.
Couplings	This command is an alias to [ :SENSe ] :ACPower:CARRier [ 1 ]   2 :LIST:FILTer [ :RRC ] [ :STATe ] The enum value translates as follows: RRC Weighted = 1 ON Integ BW = 0 OFF Maximum of Array length depends on the number of carriers.
Preset	SA: IBW WCDMA: RRC WIMAX OFDMA: IBW TD-SCDMA: RRC DVB-T/H: IBW DTMB (CTTB): RRC ISDB-T: IBW CMMB: IBW LTE, MSR: IBW LTETDD: IBW Digital Cable TV: RRC
State Saved	Saved in instrument state.

---

Initial S/W Revision	Prior to A.02.00
Modified at S/W Revision	A.03.00

---

## Mode

See "[Mode](#)" on page 140

## Mode Preset

Returns the active mode to a known state.

Mode Preset does the following for the currently active mode:

- Aborts the currently running measurement.
- Brings up the default menu for the mode, with no active function.
- Sets measurement Global settings to their preset values for the active mode only.
- Activates the default measurement.
- Brings up the default menu for the mode.
- Clears the input and output buffers.
- Sets Status Byte to 0.

Mode Preset does not:

- Cause a mode switch
- Affect mode persistent settings
- Affect system settings
- See "[How-To Preset](#)" on page 666 for more information.

Key Path	Front-panel key
<b>Remote Command</b>	:SYSTem:PRESet
<b>Example</b>	:SYST:PRES
Notes	*RST is preferred over :SYST:PRES for remote operation. *RST does a Mode Preset, as done by the :SYST:PRES command, and it sets the measurement mode to Single measurement rather than Continuous for optimal remote control throughput. Clears all pending OPC bits. The Status Byte is set to 0.
Couplings	A Mode Preset aborts the currently running measurement, activates the default measurement, and gets the mode to a consistent state with all of the default couplings set.
Backwards Compatibility Notes	In the X-Series, the legacy "Factory Preset" has been replaced with Mode Preset, which only presets the currently active mode, not the entire instrument. In the X-Series, the way to preset the entire instrument is by using System, Restore System Defaults All, which behaves essentially the same way as restore System Defaults does on ESA and PSA. There is also no "Preset Type" as there is on the PSA. There is a green Mode Preset front-panel key that does a Mode Preset and a white-with-green-letters User Preset front-panel key that does a User Preset. The old PRESet:TYPE command is ignored (without generating an error), and SYST:PRES without a parameter does a Mode Preset, which should cover most backward code compatibility issues. The settings and correction data under the Input/Output front-panel key (examples: Input Z Corr, Ext Amp Gain, etc.) are no longer part of any Mode, so they will not be preset by a Mode Preset. They are preset using Restore Input/Output Defaults, Restore System Defaults All. Note that because User Preset does a Recall State, and all of these settings are saved in State, they ARE recalled when using

	User Preset.
Initial S/W Revision	Prior to A.02.00

## How-To Preset

The table below shows all possible presets, their corresponding SCPI commands and front-panel access (key paths). Instrument settings depend on the current measurement context. Some settings are local to the current measurement, some are global (common) across all the measurements in the current mode, and some are global to all the available modes. In a similar way, restoring the settings to their preset state can be done within the different contexts.

Auto Couple - is a measurement local key. It sets all Auto/Man parameter couplings in the measurement to Auto. Any Auto/Man selection that is local to other measurements in the mode will not be affected.

Meas Preset - is a measurement local key. Meas Preset resets all the variables local to the current measurement except the persistent ones.

Mode Preset - resets all the current mode's measurement local and measurement global variables except the persistent ones.

Restore Mode Defaults - resets ALL the Mode variables (and all the Meas global and Meas local variables), including the persistent ones.

Type Of Preset	SCPI Command	Front Panel Access
Auto Couple	:COUPle ALL	Auto Couple front-panel key
Meas Preset	:CONFigure:<Measurement>	Meas Setup Menu
Mode Preset	:SYSTem:PRESet	Mode Preset (green key)
Restore Mode Defaults	:INSTrument:DEFault	Mode Setup Menu
Restore All Mode Defaults	:SYSTem:DEFault MODes	System Menu; Restore System Default Menu
*RST	*RST	not possible (Mode Preset with Single)
Restore Input/Output Defaults	:SYSTem:DEFault INPUt	System Menu; Restore System Default Menu
Restore Power On Defaults	:SYSTem:DEFault PON	System Menu; Restore System Default Menu
Restore Alignment Defaults	:SYSTem:DEFault ALIGN	System Menu; Restore System Default Menu
Restore Miscellaneous Defaults	:SYSTem:DEFault MISC	System Menu; Restore System Default Menu
Restore All System Defaults	:SYSTem:DEFault [ALL] :SYSTem:PRESet:PERsistent	System Menu; Restore System Default Menu
User Preset	:SYSTem:PRESet:USER	User Preset Menu
User Preset All Modes	:SYSTem:PRESet:USER:ALL	User Preset Menu

Power On Mode Preset	:SYSTem:PON:TYPE MODE	System Menu
Power On User Preset	:SYSTem:PON:TYPE USER	System Menu
Power On Last State	:SYSTem:PON:TYPE LAST	System Menu

## Mode Setup

See "[Mode Setup](#)" on page 159



## Peak Search

Places the selected marker on the trace point with the maximum y-axis value.

Key Path	Peak Search
Mode	SA, WCDMA, C2K, WIMAX OFDMA, TD-SCDMA, 1xEVDO, DVB-T/H, DTMB (CTTB), ISDB-T, CMMB, LTE, LTE-TDD, Digital Cable TV, MSR, LTEAFDD, LTEATDD
<b>Remote Command</b>	:CALCulate:ACPower:MARKer [1]   2   . . .   12:MAXimum
<b>Example</b>	CALC:ACP:MARK2:MAX
Initial S/W Revision	Prior to A.02.00
Modified at S/W Revision	A.02.00, A.03.00

## Next Peak

Moves the selected marker to the peak that has the next highest amplitude.

Key Path	Peak Search
Mode	SA, WCDMA, C2K, WIMAX OFDMA, TD-SCDMA, 1xEVDO, DVB-T/H, DTMB (CTTB), ISDB-T, CMMB, LTE, LTE-TDD, Digital Cable TV, MSR, LTEAFDD, LTEATDD
<b>Remote Command</b>	:CALCulate:ACPower:MARKer [1]   2   . . .   12:MAXimum:NEXT
<b>Example</b>	CALC:ACP:MARK2:MAX:NEXT
Initial S/W Revision	Prior to A.02.00
Modified at S/W Revision	A.02.00, A.03.00

## Next Pk Right

Moves the selected marker to the nearest peak to the right of the current marker that meets all enabled peak criteria.

Key Path	Peak Search
Mode	SA, WCDMA, C2K, WIMAX OFDMA, TD-SCDMA, 1xEVDO, DVB-T/H, DTMB (CTTB), ISDB-T, CMMB, LTE, LTE-TDD, Digital Cable TV, MSR, LTEAFDD, LTEATDD
<b>Remote Command</b>	:CALCulate:ACPower:MARKer [1]   2   . . .   12:MAXimum:RIGHT
<b>Example</b>	CALC:ACP:MARK2:MAX:RIGH
Initial S/W Revision	Prior to A.02.00
Modified at S/W Revision	A.02.00, A.03.00

## Next Pk Left

Moves the selected marker to the nearest peak to the left of the current marker that meets all enabled peak criteria.

Key Path	Peak Search
Mode	SA, WCDMA, C2K, WIMAX OFDMA, TD-SCDMA, 1xEVDO, DVB-T/H, DTMB (CTTB), ISDB-T, CMMB, LTE, LTETDD, Digital Cable TV, MSR, LTEAFDD,LTEATDD
<b>Remote Command</b>	:CALCulate:ACPpower:MARKer[1] 2 ... 12:MAXimum:LEFT
<b>Example</b>	CALC:ACP:MARK2:MAX:LEFT
Initial S/W Revision	Prior to A.02.00
Modified at S/W Revision	A.02.00, A.03.00

## Marker Delta

Sets the control mode for the selected marker to Delta mode.

See Marker Delta in the "Marker Functions" section for more information.

Key Path	Peak Search
Initial S/W Revision	Prior to A.02.00

## Pk-Pk Search

Finds and displays the amplitude and frequency (or time, if in zero span) differences between the highest and lowest y-axis value.

Key Path	Peak Search
Mode	SA, WCDMA, C2K, WIMAX OFDMA, TD-SCDMA, 1xEVDO, DVB-T/H, DTMB (CTTB), ISDB-T, CMMB, LTE, LTETDD, Digital Cable TV, MSR, LTEAFDD,LTEATDD
<b>Remote Command</b>	:CALCulate:ACPpower:MARKer[1] 2 ... 12:PTPeak
<b>Example</b>	CALC:ACP:MARK:PTP
Notes	Turns on the Marker $\Delta$ active function.
Couplings	This key is not available (key is grayed out) when Coupled Markers is on.
Initial S/W Revision	Prior to A.02.00
Modified at S/W Revision	A.02.00, A.03.00

## Min Search

Moves the selected marker to the minimum y-axis value on the current trace.

Key Path	Peak Search
Mode	SA, WCDMA, C2K, WIMAX OFDMA, TD-SCDMA, 1xEVDO, DVB-T/H, DTMB (CTTB), ISDB-T, CMMB, LTE, LTE-TDD, Digital Cable TV, MSR, LTEAFDD, LTEATDD
<b>Remote Command</b>	:CALCulate:ACPower:MARKer [1]   2   . . .   12:MINimum
<b>Example</b>	CALC:ACP:MARK:MIN
Initial S/W Revision	Prior to A.02.00
Modified at S/W Revision	A.02.00, A.03.00

9 ACP Measurement  
Print

Print

See "[Print](#) " on page 183

## Quick Save

The Quick Save front-panel key repeats the most recent save that was performed from the Save menu, with the following exceptions:

- Register saves are not remembered as Saves for the purpose of the Quick Save function
- If the current measurement does not support the last non-register save that was performed, an informational message is generated, “File type not supported for this measurement”

Quick Save repeats the last type of qualified save (that is, a save qualified by the above criteria) in the last save directory by creating a unique filename using the Auto File Naming algorithm described below.

If Quick Save is pressed after startup and before any qualified Save has been performed, the Quick Save function performs a Screen Image save using the current settings for Screen Image saves (current theme, current directory), which then becomes the “last save” for the purpose of subsequent Quick Saves.

The Auto File Naming feature automatically generates a file name for use when saving a file. The filename consists of a prefix and suffix separated by a dot, as is standard for the Windows® file system. A default prefix exists for each of the available file types:

Type	Default Prefix	Menu
State	State_	(Save/Recall)
Trace + State	State_	(Save/Recall)
Screen	Screen_	(Save/Recall)
Amplitude Corrections	Ampcor_	(Import/Export)
Traces	Trace_	(Import/Export)
Limit Lines	LLine_	(Import/Export)
Measurement Result	MeasR_	(Import/Export)
Capture Buffer	CapBuf_	(Import/Export)

A four digit number is appended to the prefix to create a unique file name. The numbering sequence starts at 0000 within each Mode for each file type and updates incrementally to 9999, then wraps to 0000 again. It remembers where it was through a Mode Preset and when leaving and returning to the Mode. It is reset by Restore Misc Defaults and Restore System Defaults and subsequent running of the instrument application. So, for example, the first auto file name generated for State files is State\_0000.state. The next is State\_0001, and so forth.

One of the key features of Auto File Name is that we guarantee that the Auto File Name will never conflict with an existing file. The algorithm looks for the next available number. If it gets to 9999, then it looks for holes. If it find no holes, that is no more numbers are available, it gives an error.

For example, if when we get to State\_0010.state there is already a State\_0010.state file in the current directory, it advances the counter to State\_0011.state to ensure that no conflict will exist (and then it verifies that State\_0011.state also does not exist in the current directory and advances again if it does, and so forth).

If you enter a file name for a given file type, then the prefix becomes the filename you entered instead of the default prefix, followed by an underscore. The last four letters (the suffix) are the 4-digit number.

For example, if you save a measurement results file as “fred.csv”, then the next auto file name chosen for a measurement results save will be fred\_0000.csv.

**NOTE**

Although 0000 is used in the example above, the number that is used is actually the current number in the Meas Results sequence, that is, the number that would have been used if you had not entered your own file name.

---

**NOTE**

If the filename you entered ends with \_dddd, where d=any number, making it look just like an auto file name, then the next auto file name picks up where you left off with the suffix being dddd + 1.

---

Key Path	Front-panel key
Notes	No remote command for this key specifically.
Initial S/W Revision	Prior to A.02.00

## Recall

The Recall menu lets you choose what you want to recall, and where you want to recall it from. Among the types of files you can recall are **States and Traces**. In addition, an Import (Data) option lets you recall a number of data types stored in CSV files (as used by Excel and other spreadsheet programs).

**NOTE**

In products that run multiple instances of the X-Series Application, all instances share the same register and file location where you want to recall from.

The default paths for Recall are data type dependent and are the same as for the Save key.

Key Path	Front-panel key
Notes	<p>No remote command for this key specifically, but the :MMEM:LOAD command is available for specific file types. An example is :MMEM:LOAD:STATE &lt;filename&gt;.</p> <p>If you try to recall a State file for a mode that is not licensed or not available in the instrument, an error message will occur and the state will not change.</p>
Backwards Compatibility Notes	<p>In legacy analyzers, it was possible to load a state without affecting the trace data, limit lines or correction data. Similarly (since User Preset is actually loading a state), it was possible to do a User Preset without affecting the trace data, limit lines or correction data.</p> <p>In the X-Series, “state” always includes all of this data; so whenever state is loaded, all of the traces, limit lines and corrections are affected. Although this differs from previous behavior, it is desirable behavior, and should not cause adverse issues for users.</p>
Backwards Compatibility Notes	<p>Recall for the X-Series supports backward compatibility in the sense that you can recall a state file from any X-Series model number and any version of X-Series software. This is only possible if part of the recalling process goes through a limiting step after recalling the mode settings, at least for settings that may vary with version number, model number, option and license differences. If you try to recall a state file onto an instrument with less capability than what was available on the instrument during the save, the recall will ignore the state it doesn't support and it will limit the recalled setting to what it allows.</p> <p>Example: if the saved state includes preamp ON, but the recalling instrument does not have a preamp; the preamp is limited to OFF. Conversely, if you save a state without a preamp, the preamp is OFF in the state file. When this saved file is recalled on an instrument with a licensed preamp, the preamp is changed to OFF. Another example is if the saved state has center frequency set to 20 GHz, but the instrument recalling the saved state is a different model and only supports 13.5 GHz. In this case, the center frequency is limited along with any other frequency based settings. Since the center frequency can't be preserved in this case, the recall limiting tries to at least preserve span to keep the measurement setup as intact as possible.</p> <p>It may be appropriate to issue a warning if the state is limited on the recall; warnings do not go out to SCPI so this would only affect the manual user.</p> <p>Note that there is no state file compatibility outside of the X-Series. For example, you cannot recall a state file from ESA or PSA.</p>
Initial S/W Revision	Prior to A.02.00

## State

The Recall State menu lets you choose a register or file from which to recall the state.

The content of a state file includes all of the settings and data required to return the analyzer as closely as possible to the Mode it was in, with the exact settings that were in place, when the save occurred. The Mode settings in each state file include the settings that are affected by Mode Preset, as well as the additional settings affected by Restore Mode Defaults; all of the Mode's settings. In addition, all of the settings of the Input/Output system are included, even though they are outside of the Mode's state, because they are needed to restore the complete setup. Persistent System settings (for example, GPIB address) are not affected by either a Mode Preset or Restore Mode Defaults, nor are they included in a saved State file.

Since each state file is only for one Mode, the settings for other Modes are unaffected when it is loaded. Recall State will cause a mode switch if the state being recalled is not from the current active mode.

After the recall completes, the message "File <filename> recalled" or "Recalled State Register <register number>" is displayed.

For rapid recalls, the State menu lists 16 registers that you can choose from to recall. Pressing a Register key initiates the recall. You can also select a file from which to recall.

The default path for all State Files is:

My Documents\<mode name>\state

where <mode name> is the parameter used to select the mode with the INST:SEL command (for example, SA for the Spectrum Analyzer).

See ["More Information" on page 677](#).

<b>Key Path</b>	Recall
<b>Mode</b>	All
<b>Remote Command</b>	:MMEMory:LOAD:STATe <filename>
<b>Example</b>	:MMEM:LOAD:STAT "myState.state" This recalls the file myState.state on the default path
<b>Example</b>	MMEM:LOAD:STAT "MyStateFile.state" This loads the state file data (on the default file directory path) into the instrument state.
<b>Notes</b>	<p>When you pick a file to recall, the analyzer first verifies that the file is recallable in the current instrument by checking the software version and model number of the instrument. If everything matches, a full recall proceeds by aborting the currently running measurement, clearing any pending operations, and then loading the State from the saved state file. You can open state files from any mode, so recalling a State file switches to the mode that was active when the save occurred. After switching to the mode of the saved state file, mode settings and data (if any for the mode) are loaded with values from the saved file. The saved measurement of the mode becomes the newly active measurement and the data relevant to the measurement (if there is any) is recalled.</p> <ul style="list-style-type: none"> <li>• If there is a mismatch between file version or model number or instrument version or model number, the recall function tries to recall as much as possible and returns a warning message. It may limit settings that differ based on model number, licensing or version number.</li> </ul> <p>After recalling the state, the Recall State function does the following:</p> <ul style="list-style-type: none"> <li>• Makes the saved measurement for the mode the active measurement.</li> <li>• Clears the input and output buffers.</li> <li>• Status Byte is set to 0.</li> </ul>



	<ul style="list-style-type: none"> <li>• Executes a *CLS</li> </ul> <p>If the file specified is empty an error is generated. If the specified file does not exist, another error is generated. If there is a mismatch between the file and the proper file type, an error is generated. If there is a mismatch between file version or model number or instrument version or model number, a warning is displayed. Then it returns to the State menu and File Open dialog goes away.</p> <p>After the Recall, the analyzer exits the Recall menu and returns to the previous menu.</p>
<b>Backwards Compatibility SCPI</b>	:MMEMory:LOAD:STATe 1,<filename>
Initial S/W Revision	Prior to A.02.00

## More Information

In measurements that support saving Traces, for example, Swept SA, the Trace data is saved along with the State in the State file. When recalling the State, the Trace data is recalled as well. Traces are recalled exactly as they were stored, including the writing mode and update and display modes. If a Trace was updating and visible when the State was saved, it will come back updating and visible, and its data will be rewritten right away. When you use State to save and recall traces, any trace whose data must be preserved should be placed in View or Blank mode before saving.

The following table describes the Trace Save and Recall possibilities:

You want to recall state and one trace's data, leaving other traces unaffected.	Save Trace+State from 1 trace. Make sure that no other traces are updating (they should all be in View or Blank mode) when the save is performed.	On Recall, specify the trace you want to load the one trace's data into. This trace will load in View. All other traces' data will be unaffected, although their trace mode will be as it was when the state save was performed.
You want to recall all traces	Save Trace+State from ALL traces.	On Recall, all traces will come back in View (or Blank if they were in Blank or Background when saved)
You want all traces to load exactly as they were when saved.	Save State	On recall, all traces' mode and data will be exactly as they were when saved. Any traces that were updating will have their data immediately overwritten.

## From File...

When you press "From File", the analyzer brings up a Windows dialog and a menu entitled "File Open." This menu allows you to navigate to the various fields in the Windows dialog without using a keyboard or mouse. The Tab and Arrow keys can also be used for dialog navigation.

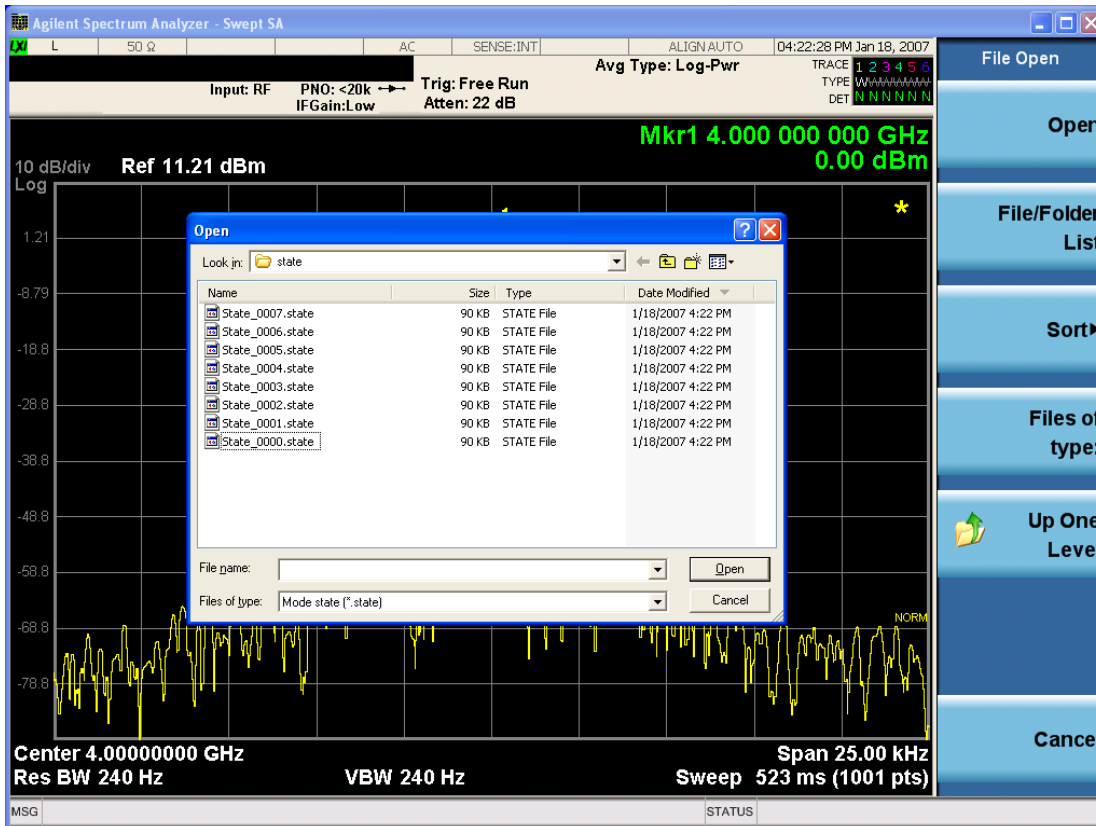

Listed below are the functions of the various fields in the dialog, and the corresponding softkeys:

#### Open

Performs the recall of the specified file. While the recall is being performed, the floppy icon appears briefly in the Meas bar.

#### File/Folder List

Enables you to navigate to the center of the dialog that contains the list of files and folders. Once here you can get information about the file and use the tab keys to navigate to the other fields in the dialog, such as Look In.

#### Look In

The Look In field shows the path from which the file will be recalled and allows you to change the path using the up and down arrow keys to navigate to other paths; the Enter key to open a directory; and the Backspace key to go back one directory. The **Look In field** first uses the last path from the Save As dialog **Save In:** path for that same file type. There is no softkey for directly navigating to the Look In field, but you can use the left tab to get here from the File/Folder List.

User specified paths are remembered when you leave and return to a Mode and are reset back to the default using Restore Mode Defaults.

#### Sort

Accesses a menu that enables you to sort the files within the File Open dialog. Only one sorting type can be selected at a time and the sorting happens immediately. The sorting types are By Date, By Name, By extension, and By Size.

#### Files of Type

This field shows the file suffix for the type of file you have selected to recall. For example, if you navigated here while recalling State, "Mode state (\*.state)" is in the field. If you navigated here while recalling Trace, ""Mode state (\*.trace)" is in the field. If you navigated here while importing a trace data file, "Trace Data (\*.csv)" is in the field. For some file types, there is more than one choice in the dropdown menu, which you can select by using the up and down arrow keys and Enter.

#### Up One Level

This key corresponds to the icon of a folder with the up arrow that is in the tool bar of the dialog. When pressed, it causes the file and folder list to navigate up one level in the directory structure. The Backspace key does the same thing.

#### Cancel

This key corresponds to the Cancel selection in the dialog. It causes the current **Open** request to be cancelled. The ESC key does the same thing.

Key Path	Recall, State
Notes	Brings up the Open dialog for recalling a State Save Type
Initial S/W Revision	Prior to A.02.00

### Edit Register Names

You may enter a custom name on any of the Register keys, to help you remember what you are using that state to save. To do this, press the Edit Register Names key, choose the register whose name you wish to edit, and then enter the desired label using the Alpha Editor or an external PC keyboard.

The maximum number of characters that can be added is 30. In most cases, 30 characters will fit on two lines of the key.

For more information and the SCPI command, see Edit Register Names under the Save, State function.

Key Path	Recall, State
Mode	All
Dependencies	N9060A-7FP or N9060B-2FP license required to edit the register names. When the feature is not licensed, sending the SCPI command generates an error, -221, "Settings conflict;Option not available"
Initial S/W Revision	A.11.00

### Register 1 thru Register 16

Selecting any one of these register keys causes the State of the mode from the specified Register to be recalled. Each of the register keys annotates whether it is empty or at what date and time it was last

modified. In addition, you can use the Edit Register Names key under Save, State to enter custom names for each register.

**NOTE**

In products that run multiple instances of the X-Series Application, recalling the same register name on each instance is a way to share setups between the instances.

Registers are shared by all modes, so recalling from any one of the registers will cause a mode switch to the mode that was active when the save to the Register occurred.

Although these 16 registers are the only registers available from the front panel, there are 128 state registers available in the instrument. Registers 17–128 are only available from the SCPI interface, using the \*RCL command.

After the recall completes, the message "Register <register number> recalled" appears in the message bar. If you are in the Spectrum Analyzer Mode, and you are recalling a register that was saved in the Spectrum Analyzer Mode, then after the recall, you will still be in the Recall Register menu. If the Recall causes you to switch modes, then after the Recall, you will be in the Frequency menu.

If a requested register is empty an error is generated.

Key Path	Recall, State
Example	*RCL 1
Range	1–16 from front panel, 1–128 from SCPI
Readback	Date and time with seconds resolution are displayed on the key OR A custom name of up to 30 characters entered using the Save, State, Edit Register Names key OR “(empty)” if no prior save operation has been performed to this register.
Initial S/W Revision	Prior to A.02.00
Modified at S/W Revision	Prior to A.11.00

## Register 1 thru Register 16

Selecting any one of these register keys causes the State of the mode from the specified Register to be recalled. Each of the register keys annotates whether it is empty or at what date and time it was last modified. In addition, you can use the Edit Register Names key under Save, State to enter custom names for each register.

**NOTE**

In products that run multiple instances of the X-Series Application, recalling the same register name on each instance is a way to share setups between the instances.

Registers are shared by all modes, so recalling from any one of the registers will cause a mode switch to the mode that was active when the save to the Register occurred.

Although these 16 registers are the only registers available from the front panel, there are 128 state registers available in the instrument. Registers 17–128 are only available from the SCPI interface, using the \*RCL command.

After the recall completes, the message "Register <register number> recalled" appears in the message bar. If you are in the Spectrum Analyzer Mode, and you are recalling a register that was saved in the Spectrum Analyzer Mode, then after the recall, you will still be in the Recall Register menu. If the Recall causes you to switch modes, then after the Recall, you will be in the Frequency menu.

If a requested register is empty an error is generated.

Key Path	Recall, State
<b>Example</b>	*RCL 1
Range	1-16 from front panel, 1-128 from SCPI
Readback	Date and time with seconds resolution are displayed on the key OR A custom name of up to 30 characters entered using the Save, State, Edit Register Names key OR “(empty)” if no prior save operation has been performed to this register.
Initial S/W Revision	Prior to A.02.00
Modified at S/W Revision	Prior to A.11.00

## Sequences

These keys allow you to import a Tab separated or .txt file that will automatically setup all the parameters required for building a Sequence. The parameters will automatically be loaded into the Stated Sequencer.

Once selected, in order to import the selected Sequence Type you must select the Open key in the Source Sequence menu.

Key Path	Recall, Sequences
Mode	All
<b>Remote Command</b>	:MMEMory:LOAD:SEQuences:   SLIS   ALIS   SAALIS   "MySequence.txt"
<b>Example</b>	:MMEM:LOAD:SEQ:SLIS "MySequence.txt"
Notes	Available file types are: –CSV (Comma delimited) (*.csv) –Text (Tab delimited) (*.txt)
Initial S/W Revision	A.05.00

## Source Sequence

The list of parameters, that configure steps, that makes up a sequence for the Source.

The Source sequence is a sequence of flexible configurable steps that can be set anywhere in the instruments frequency range.

Key Path	Recall, Sequences
----------	-------------------

<b>Example</b>	:MMEM:LOAD:SEQ:SLIS "MySequence.txt"
<b>Dependencies</b>	Only available in XOBT
<b>Initial S/W Revision</b>	A.05.00

### Open...

When you press “Open”, the analyzer brings up a Windows dialog and a menu entitled “**File Open.**” This menu allows you to navigate to the various fields in the Windows dialog without using a keyboard or mouse. The Tab and Arrow keys can also be used for dialog navigation.

See "[From File...](#)" on page 1336 in Recall, State, for a full description of this dialog and menu.

<b>Key Path</b>	Recall, Data
<b>Notes</b>	The key location is mode-dependent and will vary. Brings up Open dialog for recalling a <mode specific> Save Type
<b>Initial S/W Revision</b>	Prior to A.02.00

### Data (Import)

Importing a data file loads data that was previously saved from the current measurement or from other measurements and/or modes that produce compatible data files. The Import Menu only contains Data Types that are supported by the current measurement.

Since the commonly exported data files are in .csv format, the data can be edited by the user prior to importing. This allows you to export a data file, manipulate the data in Excel (the most common PC Application for manipulating .csv files) and then import it.

Importing Data loads measurement data from the specified file into the specified or default destination, depending on the data type selected. Selecting an Import Data menu key will not actually cause the importing to occur, since the analyzer still needs to know from where to get the data. Pressing the Open key in this menu brings up the Open dialog and Open menu that provides you with the options from where to recall the data. Once a filename has been selected or entered in the Open menu, the recall occurs as soon as the Open button is pressed.

<b>Key Path</b>	Recall
<b>Mode</b>	All
<b>Notes</b>	The menu is built from whatever data types are available for the mode. Some keys will be missing completely, so the key locations in the sub-menu will vary. No SCPI command directly controls the Data Type that this key controls. The Data Type is included in the MMEM:LOAD commands.
<b>Dependencies</b>	If a file type is not used by a certain measurement, it is grayed out for that measurement. The key for a file type will not show at all if there are no measurements in the Mode that support it.
<b>Preset</b>	Is not affected by Preset or shutdown, but is reset during Restore Mode Defaults

Readback	The data type that is currently selected
Initial S/W Revision	Prior to A.02.00

## Mask

Enables you to recall a preset mask file. This file type (.mask) differs from a normal “state” file because it contains the configuration for Carrier, Offset, and Limit for the specific preset profile BW. A brief description of the mask file is available in the properties view of each file. (Right-mouse-click on the file, select, “Properties” to view this information.) A detailed list of the mask parameter values is located in the .pdf file of the same name in the same directory. Blank values in the .pdf file are parameters that will not be overwritten when recalling the mask.

Key Path	Recall, Data
Mode	WIMAXOFDMA
Remote Command	:MMEMory:LOAD:MASK <string>
Example	:MMEM:LOAD:MASK "MyLimitFile.mask"
Notes	Set of parameters related to Limit, Carrier and Offset are overwritten by Preset Mask file.
Initial S/W Revision	A.02.00

This topic contains the following sections:

["File location and extension" on page 683](#)

["Example of Preset Mask file" on page 684](#)

### File location and extension

**File location:** The preset mask file is located in “My Documents\WIMAXOFDMA\data\masks”.

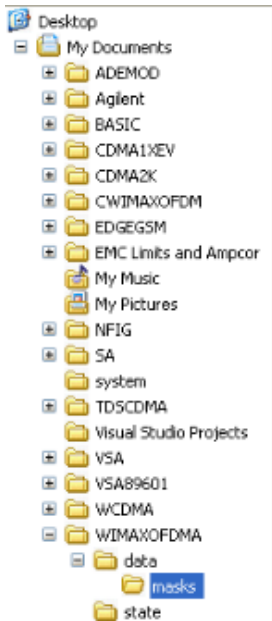

**NOTE**

When your X-Series analyzer starts, all mask files located in “My Documents\WIMAXOFDMA\data.masks” are overwritten, so any files you wish to save should be stored in another directory location.

**File type:** The file type is binary file.

**File Name:** The file name is decided by following naming rules. Each specific keyword is connected with underscore.

<Standard name>\_<Radio device>\_<Preset Profile BW>\_<Measurement>.mask

<Standard name>: This term references the standard associated with each mask file.

<Radio device>: This term specifies to which radio device (BS or MS) the mask file pertains.

<Preset Profile BW>: This term specifies to which Preset Profile BW the mask file pertains.

<Measurement>: This term specifies the measurement to which the mask file is applied. Your selections are: SEM, ACP, or Mode. When selecting **Mode**, the values of some parameters in both the ACP and SEM measurement are overwritten.

**File extension:** The extension of preset mask file is “mask” to distinguish it from a “state” file.

When you press the open key under the Data menu, the “My Documents\WIMAXOFDMA\data.masks” folder is opened. Select one mask file.

**NOTE**

When you change the preset BW profile or Radio Device, all measurement parameters are reset to their original values. Thus you have to recall the appropriate preset mask file again after the change.

**Example of Preset Mask file**

When you import a preset mask file, it is a “Recall” function. Specific parameter values are overwritten by the contents of the preset mask file (see table below). Those values not specified by the preset mask file remain unchanged. Because the file format type is binary, you cannot view, change, or create the preset mask file. Here is an example of a preset mask file used for ACP measurements.



File Location: My Documents/WIMAXOFDMA/data/masks

File Name: ETSI-EN301-021-SysE\_BS\_10MHz\_ACP.mask

The .pdf file that lists the parameters similarly to that shown below is named, "ETSI-EN301-021-SysE\_BS\_10MHz\_ACP.pdf"

The set of parameters listed in the following table for the Preset Profile BW (10MHz) are imported into the ACP measurement.

Offset	Start Freq (MHz)	Stop Freq (MHz)	Sweep Time	Res BW (Hz)	Meas BW	Rel Start	Rel Stop	Fail Mask
A	5	7.14		30k	1	-8	-25	Rel
B	7.14	10.57		30k	1	-25	-27	Rel
C	10.57	20		30k	1	-27	-50	Rel
D	20	25		30k	1	-50	-50	Rel
E	25	30		30k	1	-50	-50	Rel

## Zone Map

Pressing this key selects Zone Map as the data type to be imported.

The WiMAX-OFDMA application can load the Singal Studio Setup file, and the OFDMA Map file is compatible with the 89601A Mobile WiMAX omf file.

Key Path	Recall, Data
<b>Remote Command</b>	:MMEMory:LOAD:ZMAP <string>
<b>Example</b>	MMEM:LOAD:ZMAP "ZMap_0000.omf"
Notes	The SCPI parameter is a quoted string that specifies the filename. Both single and double quotes are supported for any filename parameter over SCPI.
Dependencies	You must be in the 802.16 OFDMA (WiMAX/WiBro) mode.
Status Bits/OPC dependencies	Sequential - waits for the previous measurement to complete.
Initial S/W Revision	Prior to A.02.00

## Open...

When you press "Open", the analyzer brings up a Windows dialog and a menu entitled "File Open." This menu allows you to navigate to the various fields in the Windows dialog without using a keyboard or mouse. The Tab and Arrow keys can also be used for dialog navigation.

See "[From File...](#)" on page 1336 in Recall, State, for a full description of this dialog and menu.

Key Path	Recall, Data
Notes	The key location is mode-dependent and will vary. Brings up Open dialog for recalling a <mode specific> Save Type
Initial S/W Revision	Prior to A.02.00

## Restart

The Restart function restarts the current sweep, or measurement, or set of averaged/held sweeps or measurements. If you are Paused, pressing Restart does a Resume.

The Restart function is accessed in several ways:

- Pressing the Restart key
- Sending the remote command INIT:IMMEDIATE
- Sending the remote command INIT:RESTART

See "[More Information](#)" on page 687

Key Path	Front-panel key
Remote Command	:INITiate[:IMMEDIATE] :INITiate:RESTART
Example	:INIT:IMM :INIT:REST
Notes	:INITiate:RESTART and :INITiate:IMMEDIATE perform exactly the same function.
Couplings	Resets average/hold count k. For the first sweep overwrites all active (update=on) traces with new current data. For application modes, it resets other parameters as required by the measurement.
Status Bits/OPC dependencies	This is an Overlapped command. The STATUS:OPERation register bits 0 through 8 are cleared. The STATUS:QUESTIONable register bit 9 (INTEgrity sum) is cleared. The SWEEPING bit is set. The MEASURING bit is set.
Backwards Compatibility Notes	For Spectrum Analysis mode in ESA and PSA, the Restart hardkey and the INITiate:RESTART command restart trace averages (displayed average count reset to 1) for a trace in Clear Write, but did not restart Max Hold and Min Hold. In the X-Series, the Restart hardkey and the INITiate:RESTART command restart not only Trace Average, but MaxHold and MinHold traces as well. For wireless comms modes in ESA and PSA, the Restart hardkey and the INITiate:RESTART command restart every measurement, which includes all traces and numeric results. There is no change to this operation.
Initial S/W Revision	Prior to A.02.00

### More Information

The **Restart** function first aborts the current sweep/measurement as quickly as possible. It then resets the sweep and trigger systems, sets up the measurement and initiates a new data measurement sequence with a new data acquisition (sweep) taken once the trigger condition is met.

If the analyzer is in the process of aligning when **Restart** is executed, the alignment finishes before the restart function is performed.

Even when set for Single operation, multiple sweeps may be taken when Restart is pressed (for example, when averaging/holding is on). Thus when we say that **Restart** "restarts a measurement," we may mean:

- It restarts the current sweep
- It restarts the current measurement
- It restarts the current set of sweeps if any trace is in Trace Average, Max Hold or Min Hold
- It restarts the current set of measurements if Averaging, or Max Hold, or Min Hold is on for the measurement
- depending on the current settings.

With **Average/Hold Number** (in **Meas Setup** menu) set to 1, or Averaging off, or no trace in Trace Average or Hold, a single sweep is equivalent to a single measurement. A single sweep is taken after the trigger condition is met; and the analyzer stops sweeping once that sweep has completed. However, with **Average/Hold Number** >1 and at least one trace set to **Trace Average, Max Hold, or Min Hold (SA Measurement)** or **Averaging on (most other measurements)**, multiple sweeps/data acquisitions are taken for a single measurement. The trigger condition must be met prior to each sweep. The sweep is stopped when the average count  $k$  equals the number  $N$  set for **Average/Hold Number**. A measurement average usually applies to all traces, marker results, and numeric results; but sometimes it only applies to the numeric results.

Once the full set of sweeps has been taken, the analyzer will go to idle state. To take one more sweep without resetting the average count, increment the average count by 1, by pressing the step up key while **Average/Hold Number** is the active function, or sending the remote command CALC:AVER:TCON UP.

## Save

The Save menu lets you choose what you want to save and where you want to save it. Among the types of files you can save are **States**, **Traces**, and **Screen Images**. In addition, an Export (Data) option lets you save a number of data types as CSV files for easy import into Excel and other spreadsheet programs.

Key Path	Front-panel key
Mode	All
Notes	No remote command for this key specifically, but the :MMEM:STORe command is available for specific file types. An example is :MMEM:STOR:STATe <filename>.
Initial S/W Revision	Prior to A.02.00

## State

The Save State menu lets you choose a register or file for saving the state.

### NOTE

In products that run multiple instances of the X-Series Application, all instances share the same register and file location where you want to save the state.

The content of a state file includes all of the settings and data required to return the analyzer as closely as possible to the Mode it was in, with the exact settings which were in place, when the save occurred. The Mode settings in each state file include the settings that are affected by Mode Preset, as well as the additional settings affected by Restore Mode Defaults; all of the Mode's settings. In addition, all of the settings of the Input/Output system are included, even though they are outside of the Mode's state, because they are needed to restore the complete setup. Persistent System settings (for example, Verbose SCPI) are not affected by either Mode Preset or Restore Mode Defaults, nor are they included in a saved State file.

After the save completes, the message "File <filename> saved" or "State Register <register number> saved" is displayed.

For rapid saving, the State menu lists 16 registers to save to. Pressing a Register key initiates the save. You can also select a file to save to.

The default path for all State Files is:

My Documents\<<mode name>\state

where <mode name> is the parameter used to select the mode with the INST:SEL command (for example, SA for the Spectrum Analyzer).

Key Path	Save
Mode	All
<b>Remote Command</b>	:MMEMory:STORe:STATe <filename>
<b>Example</b>	MMEM:STOR:STATe "MyStateFile.state" This stores the current instrument state data in the file MyStateFile.state in the default directory.
Notes	Both single and double quotes are supported for any filename parameter over remote.

After saving to a register, that register's menu key is updated with the date the time, unless a custom label has been entered for that key.

After saving to a register, you remain in the Save State menu, so that you can see the Register key update. After saving to a file, the analyzer automatically returns to the previous menu and any Save As dialog goes away.

**Backwards** :MMEMory:STORE:STATE 1,<filename>

**Compatibility SCPI** For backwards compatibility, the above syntax is supported. The "1" is simply ignored. The command is sequential.

**Initial S/W Revision** Prior to A.02.00

### To File . . .

When you press “To File”, the analyzer brings up a Windows dialog and a menu entitled “Save As.” This menu allows you to navigate to the various fields in the Windows dialog without using a keyboard or mouse. The Tab and Arrow keys can also be used for dialog navigation.

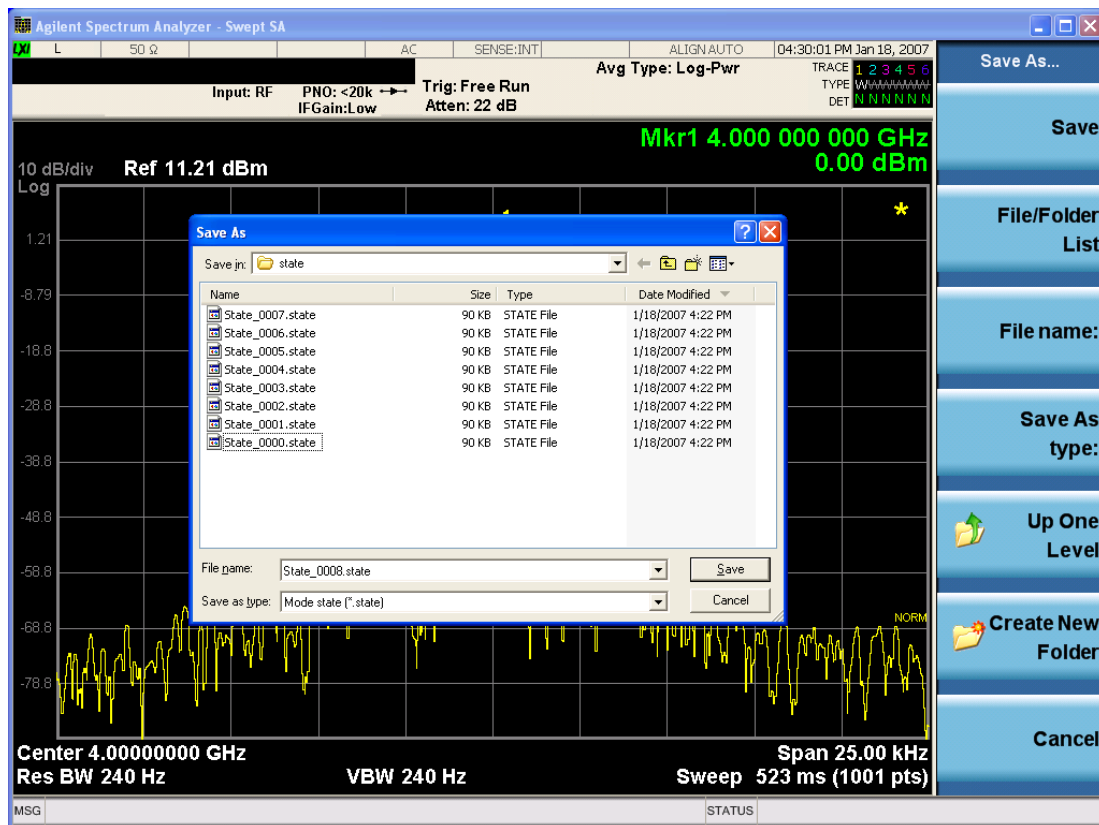

The Listed below

are the functions of the various fields in the dialog, and the corresponding softkeys:

#### Save

Performs the save to the specified file of the selected type. If the file already exists, a dialog will appear that allows you to replace the existing file by selecting OK, or you can Cancel the request. If you select OK,

the file will be overwritten. Using the C: drive is strongly discouraged, since it runs the risk of being overwritten during an instrument software upgrade.

While the save is being performed, the floppy icon appears briefly in the Meas bar.

#### File/Folder List

Enables you to navigate to the center of the dialog that contains the list of files and folders. Once here you can get information about the file and use the tab keys to navigate to the other fields in the dialog, such as Save In.

#### Save In

The Save In field shows the path to which the file will be saved and allows you to change the path using the up and down arrow keys to navigate to other paths; the Enter key to open a directory; and the Backspace key to go back one directory. The **Save In field** defaults to the default path for this type of file and remembers the last path you used to save this type of file. There is no softkey for directly navigating to the Save In field but you can use left tab to get here from the File/Folder List.

User specified paths are remembered when you leave and return to a Mode and are reset back to the default using Restore Mode Defaults.

#### File Name

The File Name field is initially loaded with an automatically generated filename specific to the appropriate Save Type. The automatically generated filename is guaranteed not to conflict with any filename currently in the directory. You may replace or modify this filename using the File Name key. See the ["Quick Save " on page 1332](#) documentation for more on the automatic file naming algorithm.

When you press the File Name key the analyzer displays the Alpha Editor. Use the knob to choose the letter to add and the front-panel Enter key to add the letter to the file name. The BK character moves you back and the FW character moves you forward in the filename. The Select key on the front panel generates a space character. When you are done entering the filename press the Done softkey. This returns back to the **File Open** dialog and menu, but does not cause the save to occur.

#### Save As Type

This field shows the file suffix for the type of file you have selected to save. For example, if you navigated here while saving State, "Mode state (\*.state)" is in the field. If you navigated here from saving Trace, ""Mode state (\*.trace)" is in the field. If you navigated here while exporting a trace data file, "Trace Data (\*.csv)" is in the field. For some file types, there is more than one choice in the dropdown, which you can select by using the up and down arrow keys and Enter.

#### Up One Level

This key corresponds to the icon of a folder with the up arrow that is in the tool bar of the dialog. When pressed, it causes the file and folder list to navigate up one level in the directory structure. The Backspace key does the same thing.

#### Create New Folder

This key corresponds to the icon of a folder with the "\*" that is in the tool bar of the dialog. When pressed, a new folder is created in the current directory with the name **New Folder** and you can enter a new folder name using the Alpha Editor.

#### Cancel

This key corresponds to the Cancel selection in the dialog. It causes the current **Save As** request to be cancelled. The ESC key does the same thing.

Key Path	Save, State
Mode	All
Notes	Brings up Save As dialog for saving a State Save Type
Initial S/W Revision	Prior to A.02.00

## Edit Register Names

You may enter a custom name on any of the Register keys, to help you remember what you are using that state to save. To do this, press the Edit Register Names key, choose the register whose name you wish to edit, and then enter the desired label using the Alpha Editor or an external PC keyboard.

The maximum number of characters that can be added is 30. In most cases, 30 characters will fit on two lines of the key.

See ["More Information" on page 692](#)

Key Path	Save, State
Mode	All
<b>Remote Command</b>	:MMEMory:REGister:STATe:LABel <reg number>,"label" :MMEMory:REGister:STATe:LABel? <reg number>
<b>Example</b>	:MMEM:REG:STAT:LAB 1,"my label"
Notes	<reg number> is an integer from 1 to 16. If the SCPI specifies an invalid register number an error message is generated, -222,"Data out of range;Invalid register label number" "label" is a string from 0 to 30 characters in length. If a label exceeds 30 characters, an error message is generated, -150,"String data error;Label clipped to 30 characters" "label" of length 0 erases the custom label and restores the default (time and date) label. E.g.: :MMEM:REG:STAT:LAB 1,""
Dependencies	N9060A-7FP or N9060B-2FP license required to edit the register names. When the feature is not licensed, sending this command generates an error, -221,"Settings conflict;Option not available"
Preset	The names are unaffected by Preset or power cycle but are set to the default label (time and date) on a "Restore System Defaults->Misc"
Initial S/W Revision	A.11.00

## More Information

When you edit one of the register names, the time and date field will be replaced by the custom name.

If you delete all the characters in the custom name, it restores the default (time and date).

The register names are stored within the state files, but they are not part of the instrument state; that is, once you have edited a register name, loading a new state will not change that register name. Another



consequence of this is that the names will be persistent through a power cycle. Also, if a named state file is transferred to another analyzer, it will bring its custom name along with it.

If you try to edit the name of an empty register, the analyzer will first save the state to have a file to put the name in. If you load a named state file into an analyzer with older firmware it will ignore the metadata.

The \*SAV and \*RCL commands will not be affected by the custom register names, nor will the MMEM commands.

## Register 1 thru Register 16

Selecting any one of these register menu keys causes the State of the currently active mode to be saved to the specified Register. The registers are provided for rapid saving and recalling, since you do not need to specify a filename or navigate to a file. Each of the register menu keys annotates whether it is empty or at what date and time it was last modified. In addition, you can use the Edit Register Names key to enter custom names for each register.

### NOTE

In products that run multiple instances of the X-Series Application, save with different register name if you do not want to overwrite the register of another running instance.

Although these 16 registers are the only registers available from the front panel, there are 128 state registers available in the instrument. Registers 17–128 are only available from the SCPI interface, using the \*SAV command.

There is one set of 128 state registers in the instrument, not one set for each Mode. When a state is saved, the Mode it was saved from is saved with it; then when it is recalled, the instrument switches to that Mode.

After the save completes, the corresponding register menu key annotation is updated with the date and time and the message "Register <register number> saved" is displayed.

Key Path	Save, State
Mode	All
Example	*SAV 1
Range	1–16 from front panel, 1–128 from SCPI
Readback	Date and time with seconds resolution are displayed on the key OR A custom name of up to 30 characters entered using the Edit Register Names key OR “(empty)” if no prior save operation has been performed to this register.
Initial S/W Revision	Prior to A.02.00
Modified at S/W Revision	A.11.00

## Register 1 thru Register 16

Selecting any one of these register menu keys causes the State of the currently active mode to be saved to the specified Register. The registers are provided for rapid saving and recalling, since you do not need to specify a filename or navigate to a file. Each of the register menu keys annotates whether it is empty or at

what date and time it was last modified. In addition, you can use the Edit Register Names key to enter custom names for each register.

**NOTE**

In products that run multiple instances of the X-Series Application, save with different register name if you do not want to overwrite the register of another running instance.

Although these 16 registers are the only registers available from the front panel, there are 128 state registers available in the instrument. Registers 17–128 are only available from the SCPI interface, using the \*SAV command.

There is one set of 128 state registers in the instrument, not one set for each Mode. When a state is saved, the Mode it was saved from is saved with it; then when it is recalled, the instrument switches to that Mode.

After the save completes, the corresponding register menu key annotation is updated with the date and time and the message "Register <register number> saved" is displayed.

Key Path	Save, State
Mode	All
<b>Example</b>	*SAV 1
Range	1–16 from front panel, 1–128 from SCPI
Readback	Date and time with seconds resolution are displayed on the key OR A custom name of up to 30 characters entered using the Edit Register Names key OR “(empty)” if no prior save operation has been performed to this register.
Initial S/W Revision	Prior to A.02.00
Modified at S/W Revision	A.11.00

### Mass Storage Catalog (Remote Command Only)

Key path	SCPI Only
<b>Remote Command</b>	:MMEMory:CATalog? [<directory_name>]
Notes	The string must be a valid logical path. Queries disk usage information (drive capacity, free space available) and obtains a list of files and directories in a specified directory in the following format: <numeric_value>,<numeric_value>,{<file_entry>} It returns two numeric parameters and as many strings as there are files and directories. The first parameter indicates the total amount of storage currently used in bytes. The second parameter indicates the total amount of storage available, also in bytes. The <file_entry> is a string. Each <file_entry> indicates the name, type, and size of one file in the directory list: <file_name>,<file_type>,<file_size> As the windows file system has an extension that indicates file type, <file_type> is always empty. <file_size> provides the size of the file in bytes. For directories, <file_entry> is surrounded by square brackets and both <file_type> and <file_size> are empty
Initial S/W Revision	Prior to A.02.00

## Mass Storage Change Directory (Remote Command Only)

Key path	SCPI Only
<b>Remote Command</b>	:MMEMory:CDIRectory [<directory_name>] :MMEMory:CDIRectory?
Notes	<p>The string must be a valid logical path.</p> <p>Changes the default directory for a mass memory file system. The &lt;directory_name&gt; parameter is a string. If no parameter is specified, the directory is set to the *RST value.</p> <p>At *RST, this value is set to the default user data storage area, that is defined as System.Environment.SpecialFolder.Personal.</p> <p>Query returns full path of the default directory.</p>
Initial S/W Revision	Prior to A.02.00

## Mass Storage Copy (Remote Command Only)

Key path	SCPI Only
<b>Remote Command</b>	:MMEMory:COPY <string>,<string>[,<string>,<string>]
Notes	<p>The string must be a valid logical path.</p> <p>Copies an existing file to a new file or an existing directory to a new directory.</p> <p>Two forms of parameters are allowed. The first form has two parameters. In this form, the first parameter specifies the source, and the second parameter specifies the destination.</p> <p>The second form has four parameters. In this form, the first and third parameters specify the source. The second and fourth parameters specify the directories. The first pair of parameters specifies the source. The second pair specifies the destination. An error is generated if the source doesn't exist or the destination file already exists.</p> <p>This command will generate an "access denied" error if the destination is a restricted folder (e.g., C:\Windows) and the current user does not have Power User or Administrator privileges.</p>

## Mass Storage Device Copy (Remote Command Only)

This command transfers data to/from a file and a peripheral device.

Key path	SCPI Only
<b>Remote Command</b>	:MMEMory:COPY:DEvice <source_string>,<dest_string>
Notes	<p>The strings must be a valid logical path or a valid device keyword. If the dest_string is a device keyword, the data is copied from the source file to the device. If the source_string is a device keyword, the data is copied to the source file from the device.</p> <p>Valid device keywords are:</p> <p>SNS (smart noise source)</p> <p>An error is generated if the file or device is not found.</p>

## Mass Storage Delete (Remote Command Only)

Key path	SCPI Only
<b>Remote Command</b>	:MMEMory:DELeTe <file_name>[,<directory_name>]
Notes	The string must be a valid logical path. Removes a file from the specified directory. The <file_name> parameter specifies the file name to be removed. This command will generate an "access denied" error if the file is in a restricted folder (e.g., C:\Windows) and the current user does not have Power User or Administrator privileges.
Initial S/W Revision	Prior to A.02.00

## Mass Storage Data (Remote Command Only)

Creates a file containing the specified data OR queries the data from an existing file.

Key path	SCPI Only
<b>Remote Command</b>	:MMEMory:DATA <file_name>, <data> :MMEMory:DATA? <file_name>
Notes	The string must be a valid logical path. The command form is MMEMory:DATA <file_name>,<data>. It loads <data> into the file <file_name>. <data> is in 488.2 block format. <file_name> is string data. The query form is MMEMory:DATA? <file_name> with the response being the associated <data> in block format.
Initial S/W Revision	Prior to A.02.00

## Mass Storage Make Directory (Remote Command Only)

Key path	SCPI Only
<b>Remote Command</b>	:MMEMory:MDIRectory <directory_name>
Notes	The string must be a valid logical path. Creates a new directory. The <directory_name> parameter specifies the name to be created. This command will generate an "access denied" error if the new directory would be in a restricted folder (e.g., C:\Windows) and the current user does not have Power User or Administrator privileges.
Initial S/W Revision	Prior to A.02.00

## Mass Storage Move (Remote Command Only)

Key path	SCPI Only
<b>Remote Command</b>	:MMEMory:MOVE <string>,<string>[,<string>,<string>]
Notes	The string must be a valid logical path. Moves an existing file to a new file or an existing directory to a new directory.

---

Two forms of parameters are allowed. The first form has two parameters. In this form, the first parameter specifies the source, and the second parameter specifies the destination.

The second form has four parameters. In this form, the first and third parameters specify the source. The second and fourth parameters specify the directories. The first pair of parameters specifies the source. The second pair specifies the destination. An error is generated if the source doesn't exist or the destination file already exists.

This command will generate an "access denied" error if the destination is a restricted folder (e.g., C:\Windows) and the current user does not have Power User or Administrator privileges.

---

Initial S/W Revision      Prior to A.02.00

---

### Mass Storage Remove Directory (Remote Command Only)

---

Key path                      SCPI Only

**Remote Command**        :MMEMory:RDIRECTory <directory\_name>

Notes                         The string must be a valid logical path.

Removes a directory. The <directory\_name> parameter specifies the directory name to be removed. All files and directories under the specified directory shall also be removed.

This command will generate an "access denied" error if the folder is a restricted folder (e.g., C:\Windows) or is in a restricted folder and the current user does not have Power User or Administrator privileges.

---

Initial S/W Revision        Prior to A.02.00

---

### Mass Storage Determine Removable Media (Remote Command Only)

This command is used to determine if any removable media devices are connected to the instrument. Primarily, these are USB memory devices plugged-in to the front panel or rear panel USB ports. On instruments with PC6 or PC7 CPU's, one SD card slot is available for removable media. The instrument's primary disk drive is not a removable media device.

---

Key Path                      SCPI Only

**Remote Command**        :MMEMory:RMEDIA:LIST?

Notes                         The return value will be a string containing a list of partition identifiers which are removable media devices. Each identifier will be separated by a comma. If no removable media is present, an empty string will be returned.

Examples:

One removable device present will result in a return string of "F:".

Two removable devices present will result in a return string of "F:,G:".

No removable devices present will result in a return string of "".

---

Initial S/W Revision        x.15.00

---

### Mass Storage Determine Removable Media Label (Remote Command Only)

This command is used to set or query a removable media device's label.

Key Path	SCPI Only
Remote Command	:MMEMory:RMEDia:LABel <partition>,<string> :MMEMory:RMEDia:LABel? <partition>
Example	MMEM:RMED:LAB "F:","My Device"
Notes	If the <partition> specified does not exist or is not a removable media device the error -252,"Missing Media" will be generated. Setting the removable media label requires Administrative privileges. If the currently logged in user does not have appropriate privileges the error "-221.9900,Settings conflict;Administrator privileges required" is generated.
Initial S/W Revision	x.15.00

### Mass Storage Determine Removable Media Write-protect status (Remote Command Only)

This command is used to query a removable media device's write-protect status.

Key Path	SCPI Only
Remote Command	:MMEMory:RMEDia:WPRotect? <partition>
Example	MMEM:RMED:WPR? "F:"
Notes	The return value is 1 if the device is write-protected, and 0 if the device is write-enabled. If the <partition> specified does not exist or is not a removable media device the error -252,"Missing Media" will be generated.
Preset	The return value will be depending on SD card installed.
Initial S/W Revision	x.15.00

### Mass Storage Determine Removable Media size (Remote Command Only)

This command is used to query a removable media device's total memory size (not available memory size).

Key Path	SCPI Only
Remote Command	:MMEMory:RMEDia:SIZE? <partition>
Example	MMEM:RMED:SIZE? "F:"
Notes	The return value is integer value in GBytes. Any device which is less than 1 GB will return 0 GB. If the <partition> specified does not exist or is not a removable media device the error -252,"Missing Media" will be generated.
Initial S/W Revision	x.15.00

## Sequences

These keys allow you to save a Tab separated or CSV file of the setup parameters required to build a Sequence.

In order to save you must select the Save As button and choose a destination folder.

Key Path	Save, Sequences
Mode	All
Remote Command	:MMEM:STOR:SEquences:   SLIS   ALIS   SAALIS   SStep "MySequence.txt"
Example	:MMEM:STOR:SEQ:SLIS "MySequence.txt"
Notes	Available file types are: –CSV (Comma delimited) (*.csv) –Text (Tab delimited) (*.txt)
Initial S/W Revision	A.05.00

## Source Sequence

The list of parameters, that configure steps, that makes up a sequence for the Source.

The Source sequence is a sequence of flexible configurable steps that can be set anywhere in the instruments frequency range.

Key Path	Save, Sequences
Example	:MMEM:STOR:SEQ:SLIS "MySequence.txt"
Dependencies	Only available in XOBT
Initial S/W Revision	A.05.00

## Save As . . .

This menu lets you select the location where you can save the Sequence. This menu is a standard Windows® dialog with Save As menu keys. The "File Name" field in the Save As dialog is initially loaded with an automatically generated filename specific to the appropriate Save Type. The automatically generated filename is guaranteed not to conflict with any filename currently in the directory. You may replace or modify this filename using the File Name softkey. See the Quick Save key documentation for more on the automatic file naming algorithm.

The default path for all Sequence Files is:

My Documents\Sequences

Key Path	Save, Sequences
Mode	All

Notes	Brings up Save As dialog for saving a Sequence Save Type
Initial S/W Revision	A.05.00

## Data (Export)

Exporting a data file stores data from the current measurement to mass storage files. The Export Menu only contains data types that are supported by the current measurement.

Since the commonly exported data files are in .csv format, the data can be edited by you prior to importing. This allows you to export a data file, manipulate the data in Excel (the most common PC Application for manipulating .csv files) and then import it.

Selecting an Export Data menu key will not actually cause the exporting to occur, since the analyzer still needs to know where you wish to save the data. Pressing the Save As key in this menu brings up the Save As dialog and Save As menu that allows you to specify the destination file and directory. Once a filename has been selected or entered in the Open menu, the export will occur as soon as the Save key is pressed.

Key Path	Save
Mode	All
Notes	The menu is built from whatever data types are available for the mode. So the key locations in the sub menu will vary. No SCPI command directly controls the Data Type that this key controls. The Data Type is included in the MMEM:STOR commands.
Dependencies	If a file type is not used by a certain measurement, that type is grayed out for that measurement. The key for a file type will not show at all if there are no measurements in the Mode that support it.
Preset	Is not affected by a Preset or shutdown, but is reset during Restore Mode Defaults
Readback	The data type that is currently selected
Initial S/W Revision	Prior to A.02.00

## Measurement Results

Pressing this key selects Meas Results as the data type to be exported.

The Meas Results file contains information which describes the current state of the analyzer. It is detailed in Meas Result File Contents below.

Key Path	Save, Data
Remote Command	:MMEMory:STORe:RESults <string>
Example	:MMEM:STOR:RES "MeasR_0000.csv"
Notes	If the save is initiated via SCPI and the file already exists, the file will be overwritten. The SCPI command exports ACP measurement results to the file specified as the parameter in the current path. The default path is My Documents\<current mode>\data\ACP\results. Using the C: drive is strongly discouraged, since it runs the risk of being overwritten during an



	instrument software upgrade. The SCPI parameter is a quoted string that specifies the filename. Both single and double quotes are supported for any filename parameter over SCPI.
Dependencies	The current active measurement must be the ACP measurement to use this command.
Status Bits/OPC dependencies	Sequential – waits for the previous measurement to complete
Initial S/W Revision	Prior to A.02.00

### Meas Results File Contents

A Meas Results File contains measurement results with the following information.

- File ID string, which is “MeasResult”
- Measurement ID following Mode ID, which is “SA:ACP” for example.
- Firmware rev and model number
- Option string
- Auto Scaling
- Auto Sweep Time Rules
- Automatic Trigger Time
- Automatic Trigger Time State
- Average Mode
- Average Number
- Average State
- Bar Graph
- Carrier Coupling
- Carrier Pwr Present
- Carrier Spacing
- Carriers
- Center Frequency
- Center Frequency Step
- Center Frequency Step State
- Detector Auto
- Detector Selection
- Electrical Atten

- Electrical Atten State
- External Array Trigger Delay
- External Array Trigger Delay State
- External Array Trigger Level
- External Array Trigger Slope
- Filter Alpha
- Filter BW
- Filter Type
- Internal Preamp
- Internal Preamp Band
- Limit Test
- Line Trigger Delay
- Line Trigger Delay State
- Line Trigger Slope
- Meas Method
- Meas Type
- Measurement Noise Bandwidth
- Mechanical Atten
- MechanicalAttenStepEnum
- Method
- Noise Correction
- Offset Abs Limit
- Offset Fail
- Offset Filter Alpha
- Offset Filter BW
- Offset Filter Type
- Offset Freq
- Offset Freq State
- Offset Integ BW
- Offset Method
- Offset Rel Lim (Car)

- Offset Rel Lim (PSD)
- Offset Res BW
- Offset Res BW Mode
- Offset Video BW
- Offset Video BW Mode
- Periodic Timer Period
- Periodic Timer Sync Source
- Periodic Timer Trigger Delay
- Periodic Timer Trigger Delay State
- Points
- Power Ref
- Power Ref State
- Preselector Adjust
- PSD Ref
- PSD Unit
- Ref Car Freq
- Ref Car Freq State
- Ref Carrier
- Ref Carrier Mode
- Ref Position
- Ref Value
- Res BW
- Res BW Mode
- RFBurst Trigger Delay
- RFBurst Trigger Delay State
- RFBurst Trigger Level Abs
- RFBurst Trigger Level Rel
- RFBurst Trigger Level Type
- RFBurst Trigger Slope
- Scale/Div
- Span

- Sweep Time
- Sweep Time Auto
- Trigger Holdoff
- Trigger Holdoff State
- Trigger Source
- Video BW
- Video BW Auto

The file contains these data followed by MeasResult1, MeasResult2, and MeasResult3 that flag the start of the measurement results. Each line of Measurement Results consists of three comma separated values, MeasResult1 value, MeasResult2 value, and MeasResult3 value. MeasResult1 contains the same result as MEAS/READ/FETCH:ACPower1; MeasResult2, MEAS/READ/FETCH:ACPower2; MeasResult3, MEAS/READ/FETCH:ACPower3.

Exported file is .csv file. The Meas Results file, when imported into Excel, will show the following data:

MeasResult	
SA:ACP	
A.10.53	N9030A
526 ALV ATP	1
B1X B1Y B25	
B40 BBA CR3	
CRP DCF DDA	
DP2 DRD EA3	
EDP EMC EP1	
ERC ESC ESP	
EXM FSA LFE	
LNP MAT MPB	
NFE NUL P26	
PFR PNC RTL	
RTS S40 SB1	
SEC SM1 TVT	
YAS YAV	
Auto Scaling	TRUE
Auto Sweep Time Rules	Accy
Automatic Trigger Time	0.1
Automatic Trigger Time State	FALSE
Average Mode	Exponential
Average Number	10

Average State	TRUE											
Bar Graph	TRUE											
Carrier Coupling	TRUE	TRUE	TRUE	TRUE	TRUE	TRUE	TRUE	TRUE	TRUE	TRUE	TRUE	TRUE
Carrier Pwr Present	Yes	Yes	Yes	Yes	Yes	Yes	Yes	Yes	Yes	Yes	Yes	Yes
Carrier Spacing	5000000	500000	500000	500000	500000	500000	500000	500000	500000	500000	500000	500000
Carriers	1											
Center Frequency	1.33E+10											
Center Frequency Step	800000											
Center Frequency Step State	TRUE											
Detector Auto	TRUE											
Detector Selection	Average											
Electrical Atten	0											
Electrical Atten State	FALSE											
External Array Trigger Delay	1.00E-06	1.00E-06										
External Array Trigger Delay State	FALSE	FALSE										
External Array Trigger Level	1.2	1.2										
External Array Trigger Slope	Positive	Positive										
Filter Alpha	0.22	0.22	0.22	0.22	0.22	0.22	0.22	0.22	0.22	0.22	0.22	0.22
Filter BW	Minus3dB											
Filter Type	Gaussian											
Internal Preamp	FALSE											
Internal Preamp Band	Low											

Limit Test	FALSE												
Line Trigger Delay	1.00E-06												
Line Trigger Delay State	FALSE												
Line Trigger Slope	Positive												
Meas Method	IbwSpeed												
Meas Type	TPRef												
Measurement Noise Bandwidth	2000000	2000000	200000	200000	200000	200000	200000	200000	200000	200000	200000	200000	200000
Mechanical Atten	10												
MechanicalAttenStepEnum	S2dB												
Method	IBW	IBW	IBW	IBW	IBW	IBW	IBW	IBW	IBW	IBW	IBW	IBW	IBW
Noise Correction	FALSE												
Offset Abs Limit	0	0	0	0	0	0							
Offset Fail	Relative	Relative	Relative	Relative	Relative	Relative							
Offset Filter Alpha	0.22												
Offset Filter BW	Minus3dB	Minus3dB	Minus3dB	Minus3dB	Minus3dB	Minus3dB							
Offset Filter Type	Gaussian	Gaussian	Gaussian	Gaussian	Gaussian	Gaussian							
Offset Freq	3000000	0	0	0	0	0							
Offset Freq State	TRUE	FALSE	FALSE	FALSE	FALSE	FALSE							
Offset Integ BW	2000000	2000000	200000	200000	200000	200000							
Offset Method	FALSE												
Offset Rel Lim (Car)	-45	-60	0	0	0	0							
Offset Rel Lim (PSD)	-28.87	-43.87	0	0	0	0							

Offset Res BW	220000	220000	220000	220000	220000	220000
Offset Res BW Mode	TRUE	TRUE	TRUE	TRUE	TRUE	TRUE
Offset Video BW	22000	22000	22000	22000	22000	22000
Offset Video BW Mode	TRUE	TRUE	TRUE	TRUE	TRUE	TRUE
Periodic Timer Period	0.02					
Periodic Timer Sync Source	None					
Periodic Timer Trigger Delay	1.00E-06					
Periodic Timer Trigger Delay State	FALSE					
Points	1001					
Power Ref	-76.81 dBm					
Power Ref State	On					
Preselector Adjust	0					
PSD Ref	-139.82 dBm/Hz					
PSD Unit	DbmHz					
Ref Car Freq	13.25500000 GHz					
Ref Car Freq State	On					
Ref Carrier	1					
Ref Carrier Mode	On					
Ref Position	Top					
Ref Value	-30					
Res BW	220000					
Res BW Mode	FALSE					
RFBurst Trigger Delay	1.00E-06					
RFBurst Trigger Delay	FALSE					

State		
RFBurst Trigger Level Abs	-20	
RFBurst Trigger Level Rel	-6	
RFBurst Trigger Level Type	Absolute	
RFBurst Trigger Slope	Positive	
Scale/Div	10	
Span	8000000	
Sweep Time	0.02	
Sweep Time Auto	TRUE	
Trigger Holdoff	0.1	
Trigger Holdoff State	FALSE	
Trigger Source	Free	
Video BW	22000	
Video BW Auto	TRUE	
MeasResult1	MeasResult 2	Meas Result 3
- 76.80585177 44559	0	1
0.084790019 950006	- 76.80585 17744559	0
0.028392912 8313787	-999	1
	-999	0
	-999	1

## Zone Map

Pressing this key selects Zone Map as the data type to be exported.

The Zone Map file contains information about current Zone Map configuration. Its format is compatible with the 89601A OFDMA map file. It is detailed in "[Zone Map File Contents](#)" on page 709 below.



Key Path	Save, Data
Remote Command	:MMEMory:STORe:ZMAP <string>
Example	MMEM:STOR:ZMAP "ZMap_0000.omf"
Notes	<p>If the save is initiated via SCPI and the file already exists, the file will be overwritten.</p> <p>The SCPI command exports Zone Map information to the file specified as the parameter in the current path. The default path is My Documents\WIMAXOFDMA\.</p> <p>Using the C: drive is strongly discouraged, since it runs the risk of being overwritten during an instrument software upgrade.</p> <p>The SCPI parameter is a quoted string that specifies the filename. Both single and double quotes are supported for any filename parameter over SCPI.</p>
Dependencies	You must be in the 802.16 OFDMA (WiMAX/WiBro) mode.
Status Bits/OPC dependencies	Sequential - waits for the previous measurement to complete.
Initial S/W Revision	Prior to A.02.00

## Zone Map File Contents

A Zone Map File contains the following information of the Zone Map configuration. See ["Zone Map Data" on page 171](#) for detailed definitions.

- DemodOfdmaMap\_AutoDetect
- DemodOfdmaMap\_Count
- DemodOfdmaMap\_F1\_DL\_Count
- DemodOfdmaMap\_F1\_DL\_Z1\_Active
- DemodOfdmaMap\_F1\_DL\_Z1\_AmcType
- DemodOfdmaMap\_F1\_DL\_Z1\_B1\_Active
- DemodOfdmaMap\_F1\_DL\_Z1\_B1\_AllocType
- DemodOfdmaMap\_F1\_DL\_Z1\_B1\_Boost
- DemodOfdmaMap\_F1\_DL\_Z1\_B1\_BurstType
- DemodOfdmaMap\_F1\_DL\_Z1\_B1\_ColorIndex
- DemodOfdmaMap\_F1\_DL\_Z1\_B1\_ModType
- DemodOfdmaMap\_F1\_DL\_Z1\_B1\_Name
- DemodOfdmaMap\_F1\_DL\_Z1\_B1\_SubchannelInterval
- DemodOfdmaMap\_F1\_DL\_Z1\_B1\_SubchannelOffset
- DemodOfdmaMap\_F1\_DL\_Z1\_B1\_SymbolInterval
- DemodOfdmaMap\_F1\_DL\_Z1\_B1\_SymbolOffset

- DemodOfdmaMap\_F1\_DL\_Z1\_Count
- DemodOfdmaMap\_F1\_DL\_Z1\_DedicPilots
- DemodOfdmaMap\_F1\_DL\_Z1\_IDCell
- DemodOfdmaMap\_F1\_DL\_Z1\_IDCellCouple
- DemodOfdmaMap\_F1\_DL\_Z1\_Len
- DemodOfdmaMap\_F1\_DL\_Z1\_Locked
- DemodOfdmaMap\_F1\_DL\_Z1\_Name
- DemodOfdmaMap\_F1\_DL\_Z1\_PrbsID
- DemodOfdmaMap\_F1\_DL\_Z1\_StcMatrix
- DemodOfdmaMap\_F1\_DL\_Z1\_StcType
- DemodOfdmaMap\_F1\_DL\_Z1\_SymOffset
- DemodOfdmaMap\_F1\_DL\_Z1\_UseAllSC
- DemodOfdmaMap\_F1\_DL\_Z1\_WrapType
- DemodOfdmaMap\_F1\_DL\_Z1\_ZoneType
- DemodOfdmaMap\_F1\_UL\_Count
- DemodOfdmaMap\_F1\_UL\_Z1\_Active
- DemodOfdmaMap\_F1\_UL\_Z1\_AmcType
- DemodOfdmaMap\_F1\_UL\_Z1\_B1\_Active
- DemodOfdmaMap\_F1\_UL\_Z1\_B1\_AllocType
- DemodOfdmaMap\_F1\_UL\_Z1\_B1\_Boost
- DemodOfdmaMap\_F1\_UL\_Z1\_B1\_BurstType
- DemodOfdmaMap\_F1\_UL\_Z1\_B1\_ColorIndex
- DemodOfdmaMap\_F1\_UL\_Z1\_B1\_ModType
- DemodOfdmaMap\_F1\_UL\_Z1\_B1\_Name
- DemodOfdmaMap\_F1\_UL\_Z1\_B1\_PilotPattern
- DemodOfdmaMap\_F1\_UL\_Z1\_B1\_StcMode
- DemodOfdmaMap\_F1\_UL\_Z1\_B1\_SubchannelInterval
- DemodOfdmaMap\_F1\_UL\_Z1\_B1\_SubchannelOffset
- DemodOfdmaMap\_F1\_UL\_Z1\_B1\_SymbolInterval
- DemodOfdmaMap\_F1\_UL\_Z1\_B1\_SymbolOffset
- DemodOfdmaMap\_F1\_UL\_Z1\_Count

- DemodOfdmaMap\_F1\_UL\_Z1\_Gap
- DemodOfdmaMap\_F1\_UL\_Z1\_IDCell
- DemodOfdmaMap\_F1\_UL\_Z1\_Len
- DemodOfdmaMap\_F1\_UL\_Z1\_Locked
- DemodOfdmaMap\_F1\_UL\_Z1\_Name
- DemodOfdmaMap\_F1\_UL\_Z1\_SymOffset
- DemodOfdmaMap\_F1\_UL\_Z1\_UseSubchRotate
- DemodOfdmaMap\_F1\_UL\_Z1\_WrapType
- DemodOfdmaMap\_F1\_UL\_Z1\_ZoneType
- DemodOfdmaMap\_Name
- DemodOfdmaMap\_RefreshMap

### Save As . . .

When you press “Save As”, the analyzer brings up a Windows dialog and a menu entitled “**Save As.**” This menu allows you to navigate to the various fields in the Windows dialog without using a keyboard or mouse. The Tab and Arrow keys can also be used for dialog navigation.

See "[To File . . .](#)" on page 1349 in Save, State for a full description of this dialog and menu.

The default path for saving files is:

For all of the Trace Data Files:

My Documents\`<mode name>`\data\traces

For all of the Limit Data Files:

My Documents\`<mode name>`\data\limits

For all of the Measurement Results Data Files:

My Documents\`<mode name>`\data\`<measurement name>`\results

For all of the Capture Buffer Data Files:

My Documents\`<mode name>`\data\captureBuffer

Key Path	Save, Data
Mode	All
Notes	The key location is mode-dependent and will vary. Brings up the Save As dialog for saving a <code>&lt;mode specific&gt;</code> Save Type. The save is performed immediately and does not wait until the measurement is complete.
Initial S/W Revision	Prior to A.02.00

## Screen Image

Pressing Screen Image accesses a menu of functions that enable you to specify a format and location for the saved screen image. It brings up a menu that allows you to specify the color scheme of the Screen Image (Themes) or navigate to the Save As dialog to perform the actual save.

Screen Image files contain an exact representation of the analyzer display. They cannot be loaded back onto the analyzer, but they can be loaded into your PC for use in many popular applications.

The image to be saved is actually captured when the Save front panel key is pressed, and kept in temporary storage to be used if you ask for a Screen Image save. When the Screen Image key is pressed, a "thumbnail" of the captured image is displayed, as shown below:

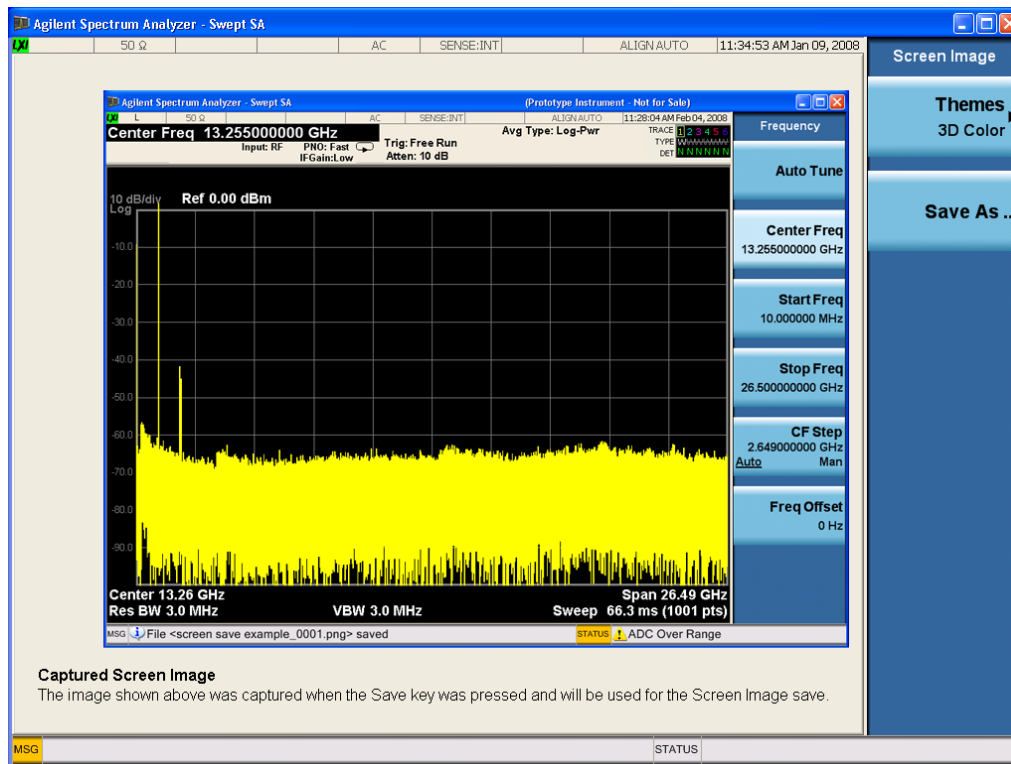

When you continue on into the Save As menu and complete the Screen Image save, the image depicted in the thumbnail is the one that gets saved, showing the menus that were on the screen before going into the Save menu. The save is performed immediately and does not wait until the measurement is complete.

After you have completed the save, the Quick Save front-panel key lets you quickly repeat the last save performed, using an auto-named file, with the current screen data.

**NOTE**

For versions previous to A.01.55, if you initiate a screen image save by navigating through the Save menus, the image that is saved will contain the Save menu softkeys, not the menus and the active function that were on the screen when you first pressed the Save front panel key.

Key Path	Save
Mode	All

<b>Remote Command</b>	:MMEMory:STORe:SCReen <filename>
<b>Example</b>	:MMEM:STOR:SCR "myScreen.png" This stores the current screen image in the file MyScreenFile.png in the default directory.
Initial S/W Revision	Prior to A.02.00

## Themes

Accesses a menu of functions that enable you to choose the theme to be used when saving the screen image.

The **Themes** option is the same as the **Themes** option under the **Display** and **Page Setup** dialogs. It allows you to choose between themes to be used when saving the screen image.

<b>Key Path</b>	Save, Screen Image
<b>Remote Command</b>	:MMEMory:STORe:SCReen:THEMe TDColor   TDMonochrome   FCOLOR   FMONochrome  :MMEMory:STORe:SCReen:THEMe?
<b>Example</b>	:MMEM:STOR:SCR:THEM TDM
Preset	3D Color; Is not part of Preset, but is reset by Restore Misc Defaults or Restore System Defaults All and survives subsequent running of the modes.
Readback	3D Color   3D Mono   Flat Color   Flat Mono
Backwards Compatibility Notes	In ESA and PSA we offer the choice of "Reverse Bitmap" or "Reverse Metafile" when saving screen images. This is much like the "Flat Color" theme available in X-Series. Also, if you selected Reverse Bitmap AND a black & white screen image, that would be much like "Flat Monochrome". In other words, each of the X-Series themes has a similar screen image type in ESA/PSA. But they are not identical.
Initial S/W Revision	Prior to A.02.00

## 3D Color

Selects a standard color theme with each object filled, shaded and colored as designed.

<b>Key Path</b>	Save, Screen Image, Themes
<b>Example</b>	MMEM:STOR:SCR:THEM TDC
Readback	3D Color
Initial S/W Revision	Prior to A.02.00

## 3D Monochrome

Selects a format that is like 3D color but shades of gray are used instead of colors.

Key Path	Save, Screen Image, Themes
<b>Example</b>	MMEM:STOR:SCR:THEM TDM
Readback	3D Mono
Initial S/W Revision	Prior to A.02.00

### Flat Color

Selects a format that is best when the screen is to be printed on an ink printer.

Key Path	Save, Screen Image, Themes
<b>Example</b>	MMEM:STOR:SCR:THEM FCOL
Readback	Flat Color
Initial S/W Revision	Prior to A.02.00

### Flat Monochrome

Selects a format that is like Flat Color. But only black is used (no colors, not even gray), and no fill.

Key Path	Save, Screen Image, Themes
<b>Example</b>	MMEM:STOR:SCR:THEM FMON
Readback	Flat Mono
Initial S/W Revision	Prior to A.02.00

### Save As...

When you press "Save As", the analyzer brings up a Windows dialog and a menu entitled "**Save As.**" This menu allows you to navigate to the various fields in the Windows dialog without using a keyboard or mouse. The Tab and Arrow keys can also be used for dialog navigation.

See "[To File ...](#)" on page 1349 in Save, State for a full description of this dialog and menu.

The default path for Screen Images is

My Documents\`<mode name>`\screen.

where `<mode name>` is the parameter used to select the mode with the INST:SEL command (for example, SA for the Spectrum Analyzer).

Key Path	Save, Screen Image
Notes	Brings up Save As dialog for saving a Screen Image Save Type
Initial S/W Revision	Prior to A.02.00

## Single (Single Measurement/Sweep)

Sets the analyzer for Single measurement operation. The single/continuous state is Meas Global, so the setting will affect all the measurements. If you are Paused, pressing Single does a Resume.

See ["More Information" on page 715](#)

Key Path	Front-panel key
Example	:INIT:CONT OFF
Notes	See Cont key description.
Backwards Compatibility Notes	<p>For Spectrum Analysis mode in ESA and PSA, the Single hardkey and the INITiate:IMM switched from continuous measurement to single measurement and restarted sweeps and averages (displayed average count reset to 1), but did not restart Max Hold and Min Hold. In the X-Series, the Single hardkey and the INITiate:IMM command initiate a sweep/ measurement/ average sequence/hold sequence including MaxHold and MinHold.</p> <p>For Spectrum Analysis mode in ESA and PSA, the Single hardkey restarted the sweep regardless of whether or not you were in an active sweep or sweep sequence. In the X-Series, Restart does this but Single only restarts the sweep or sweep sequence if you are in the idle state.</p> <p>INIT[:IMM] in ESA &amp; PSA Spectrum Analysis Mode does an implied ABORT. In some other PSA Modes, INIT[:IMM] is ignored if not in the idle state. . The X-Series follows the ESA/PSA SA Mode model, which may cause some Modes to have compatibility problems.</p>
Initial S/W Revision	Prior to A.02.00

### More Information

See ["Restart" on page 1346](#) for details on the INIT:IMMEDIATE (Restart) function.

If you are already in single sweep, the INIT:CONT OFF command has no effect.

If you are already in Single Sweep, then pressing the Single key in the middle of a sweep does not restart the sweep or sequence. Similarly, pressing the Single key does not restart the sweep or sequence if the sweep is not in the idle state (for example, if you are taking a very slow sweep, or the analyzer is waiting for a trigger). Instead, it results in a message. "Already in Single, press Restart to initiate a new sweep or sequence". Even though pressing the Single key in the middle of a sweep does not restart the sweep, sending INIT:IMMEDIATE does reset it.

To take one more sweep without resetting the average count, increment the average count by 1, by pressing the step up key while **Average/Hold Number** is the active function, or sending the remote command CALC:AVER:TCON UP.

## Source

Opens a menu of keys that access various source configuration menus and settings. In the test set, pressing this key also causes the central view area to change and display the Source Control Main view.

Key Path	Front-panel key
----------	-----------------

## RF Output

This parameter sets the source RF power output state.

Key Path	Source
<b>Remote Command</b>	:OUTPut[:EXTErnal][:STATe] ON OFF 1 0 :OUTPut[:EXTErnal][:STATe]?
<b>Example</b>	OUTP OFF OUTP?
Notes	<p>The EXTErnal node is shown in RD text so the SCPI remains the same between internal and external source control. However, for EXT we do not wish to document this node to the customer since we are controlling the internal source rather than the external source.</p> <p>This setting is for the independent mode and has no effect on the <a href="#">"List Sequencer" on page 1449</a>. If the <a href="#">"Sequencer" on page 1449</a> is set to ON, the list sequencer controls the source output and this key will be grayed-out. And this setting will be none-forceful grey out on front panel to indicate out-of-scope. Non-forceful means user still can change this setting by SCPI but cannot change on front panel. When set to OFF will make source leave list sequencer and this setting will be black out and take effect immediately.</p> <p>When the RF Output is ON, an "RF" annunciator is displayed in the system settings panel. When the RF Output is turned Off, the RF annunciator is cleared. If the <a href="#">"Sequencer" on page 1449</a> is set to ON, the "RF" annunciator will be replaced by "SEQ" in the system settings panel, indicating that the output is controlled by the list sequencer.</p>
Preset	Off
Range	On   Off
Initial S/W Revision	A.05.00

## Amplitude

Allows you to access the Amplitude sub-menu.

Key Path	Source
Notes	<p>The sub-menu under this button is for independent mode and has no effect on <a href="#">"List Sequencer" on page 1449</a>. If the <a href="#">"Sequencer" on page 1449</a> is set to ON, the list sequencer controls the source output and this key will be grayed-out on front panel to indicate out-of-scope. When you set <a href="#">"Sequencer" on page 1449</a> to Off will make source leave list sequencer and this button will be black out.</p>
Initial S/W Revision	A.05.00



## RF Power

Allows you to adjust the power level of the source using the numeric keypad, step keys, or RPG. Pressing any digit, 0 through 9, on the numeric keypad brings up the unit terminator.

Please refer to the ["RF Power Range " on page 718](#) table below for the valid ranges.

Key Path	Source, Amplitude
<b>Remote Command</b>	:SOURce:POWer[:LEVel][:IMMediate][:AMPLitude] <ampl> :SOURce:POWer[:LEVel][:IMMediate][:AMPLitude]?
<b>Example</b>	:SOUR:POW -100 dBm
Notes	<p>Amplitude corrections can be specified for use with the source. In the event of amplitude corrections being applied, the valid ranges for the RF power do not change dependant on the current amplitude correction setting. If the combination of RF power + amplitude correction is higher or lower than the source output range, the Source Unleveled bit is set and the "Source Unleveled" indicator will appear on status panel to indicate that the source cannot maintain the output power that has been requested.</p> <p>When signal generator is unable to maintain the requested output level, the "Source Unleveled" indicator will appear on status panel. When the source output setting is restored to the normal range, the "Source Unleveled" is removed from status panel.</p> <p>Internal source has list sequence mode, which comprises of several steps which contain separate output power, frequency and waveform etc. When the source list sequence playing is complete, the last step keeps playing, and user can use this command to change the list sequence last step's output power.</p> <p>The multiport adapter RFIO TX ports and GPS ports cannot ensure power accuracy when power setting is lower than -130dBm, this power setting value is defined by the sum of RF Power setting and related amplitude correction value. But user settable value could be lower than this limit. When application detected there exists power setting lower than -130dBm on MPA RFIO TX ports, then popup warning message . When application detected there exists power setting lower than -130dBm on MPA GPS ports, then popup warning message . This is only warning message, and check is performed when RF is ON.</p>
Notes	The Min and Max value here defined UI settable amplitude range. This range is larger than actual amplitude range with level accuracy defined in spec.
Dependencies	The RF power is dependent on the RF output port and frequency, such that the current frequency and selected output port determine the valid range of power values.
Preset	-100 dBm
Min	The range of values depends on the current frequency and selected RF output port. Please refer to the <a href="#">"RF Power Range " on page 718</a> table below for the valid ranges.
Max	The range of values depends on the current frequency and selected RF output port. Please refer to the <a href="#">"RF Power Range " on page 718</a> table below for the valid ranges.
Initial S/W Revision	A.05.00

All other models:

### RF Power Range

RF Output Port	Frequency Range	Min Output Power	Max Output Power
High Power RF Out	10 MHz ≤ f ≤ 6 GHz	-150 dBm	20 dBm
RFIO 1 & RFIO 2	10 MHz ≤ f ≤ 6 GHz	-150 dBm	0 dBm
GPS (Note2)	10 MHz ≤ f ≤ 6 GHz	-150 dBm	0 dBm

Note: This is the UI power range, it's larger than actual spec.

Note2: GPS port is on the multiport adapter, or E6607C which has embedded MPA.

M9420A:

### RF Power Range

RF Output Port	Frequency Range	Min Output Power	Max Output Power without Option "1EA"	Max Output Power with Option "1EA"
RF Output	60 MHz ≤ f ≤ 6 GHz	-150 dBm	10 dBm	18 dBm
RFHD	60 MHz ≤ f ≤ 6 GHz	-150 dBm	10 dBm	15 dBm
RFFD	60 MHz ≤ f ≤ 6 GHz	-150 dBm	0 dBm	0 dBm

### Set Reference Power

This key allows you to set the power reference. Pressing this key turns the power reference state to ON, sets the reference power value to the current RF output power, maintains this power at the RF output, and sets the displayed power to 0.00 dB. All subsequent RF power values entered under Source>Amplitude>RF Power are interpreted as being relative to this reference power.

When you use a power reference, the signal generator outputs an RF power that is set relative to the reference power by the value entered under Source>Amplitude>RF Power as follows:

Output power = reference power – entered power

Where:

reference power equals the original RF Power entered under Source>Amplitude>RF Power and set as the reference power

entered power equals a new value entered under Source>Amplitude>Amptd Offset

In addition, the displayed power value is the same as a new value entered under Source>Amplitude>RF Power.

#### NOTE

If Power Ref is set to ON with a reference value set, entering a value under Source>Amplitude>RF Power and pressing Set Reference Power will add that value to the existing Power Ref value.

If you wish to change the reference power value to a new value entered under Source>Amplitude>RF Power, first you must set Power Ref to OFF and then press Set Reference Power.

Key Path	Source, Amplitude
Dependencies	This key is unavailable, and is grayed out when the <a href="#">"List Sequencer" on page 1449</a> is turned ON.
Initial S/W Revision	A.05.00

## Power Ref

This key allows you to toggle the state of the power reference.

When you use a power reference, the signal generator outputs an RF power that is set relative to the reference power by the value entered under Source>Amplitude>RF Power as follows:

Output power = reference power + entered power

Where:

reference power equals the original RF Power entered under Source>Amplitude>RF Power and set as the reference power

entered power equals a new value entered under Source>Amplitude>Amptd Offset

For more information on Reference Frequency refer to ["Set Reference Power " on page 1380](#)

Key Path	Source, Amplitude
<b>Remote Command</b>	:SOURce:POWer:REFerence <ampl> :SOURce:POWer:REFerence? :SOURce:POWer:REFerence:STATe OFF ON 0 1 :SOURce:POWer:REFerence:STATe?
<b>Example</b>	:SOUR:POW:REF 0.00 dBm :SOUR:POW:REF:STATe ON
Dependencies	This setting is unavailable and is grayed out when the <a href="#">"List Sequencer" on page 1449</a> is turned ON.
Couplings	This value is coupled to the <a href="#">"Set Reference Power " on page 1380</a> key such that pressing the Set Reference Power key updates the reference power with the current output power.
Preset	0.00 dBm OFF
Min	-125.00 dBm
Max	10.00 dBm
Initial S/W Revision	A.05.00

## Amptd Offset

Allows you to specify the RF output power offset value.

When the amplitude offset is set to zero (0) and you set a new offset value (positive or negative), the displayed amplitude value will change as follows and the RF output power will not change:

Displayed value = output power + offset value

Where:

output power equals the original RF Power entered under Source>Amplitude>RF Power

offset value equals the value entered under Source>Amplitude>Amptd Offset

When the amplitude offset is set to a value other than zero (0) and you enter a new RF power value under Source>Amplitude>RF Power, the displayed power will be the same as the value entered and the RF output power will be equal to the value entered minus the offset value as follows:

Output power = entered power – offset power

Displayed Power = output power + offset power

Displayed power = entered power

Where:

entered power equals the amplitude entered under Source>Amplitude>RF Power

offset power equals the value previously entered and set under Source>Amplitude>Amptd Offset

Key Path	Source, Amplitude
Remote Command	:SOURce:POWer[:LEVel][:IMMediate]:OFFSet <rel_ampl> :SOURce:POWer[:LEVel][:IMMediate]:OFFSet?
Example	:SOUR:POW:OFFS 0.00 dB
Dependencies	This setting is unavailable, and is grayed out when the List Sequencer is turned ON.
Preset	0.00 dB
Min	-200.00 dB
Max	200.00 dB
Initial S/W Revision	A.05.00

## Modulation

Allows you to toggle the state of the modulation.

Key Path	Source
Remote Command	:OUTPut:MODulation[:STATe] ON OFF 1 0 :OUTPut:MODulation[:STATe]?
Example	:OUTP:MOD OFF
Notes	This setting is for independent mode and has no effect on <a href="#">"List Sequencer" on page 1449</a> . If the <a href="#">"Sequencer" on page 1449</a> is set to ON, the list sequencer controls the source output and this key will be grayed-out. And this setting will be none-forceful grey out on front panel to indicate out-of-scope. Non-forceful means user still can change this setting by SCPI but cannot change manually on front panel. When set to Off will make source leave list sequencer and this setting will be black out and take effect immediately. When the Modulation is ON, the "MOD" annunciator is displayed in the system settings panel. When the Modulation is turned Off, the "MOD" annunciator is cleared. If the

"Sequencer" on page 1449 is set to ON, the "MOD" annunciator will be replaced by "SEQ" in the system settings panel indicating that the output is controlled by list sequencer.

Preset	Off
Range	On   Off
Initial S/W Revision	A.05.00

## Frequency

Allows you to access the Frequency sub-menu.

Key Path	Source
Notes	The sub-menu under this button is for independent mode and has no effect on "List Sequencer" on page 1449. If the "Sequencer" on page 1449 is set to ON, the list sequencer controls the source output and this key will be grayed-out. And this button will be grey out on front panel to indicate out-of-scope. When set to Off will make source leave list sequencer and this button will be black out.
Initial S/W Revision	A.05.00

## Frequency

Allows you to set the RF Output Frequency. You can adjust the frequency of the source using the numeric keypad, step keys, or RPG. Pressing any digit, 0 through 9, on the numeric keypad brings up the unit terminator.

Key Path	Source, Frequency
<b>Remote Command</b>	:SOURce:FREQuency[:CW] <freq> :SOURce:FREQuency[:CW]?
<b>Example</b>	:SOUR:FREQ 1.00 GHz
Notes	Internal source has list sequence mode, which comprises of several steps which contain separate output power, frequency and waveform etc. When the source list sequence playing is complete, the last step keeps playing, and user can use this command to change the list sequence last step's output frequency.
Couplings	The frequency value is coupled to the current channel band and number, such that updates to the band and number will update the frequency value to the corresponding absolute frequency.
Preset	1.00 GHz If license F1A or 5WC is present, the default Center Frequency should be 2.412GHz.
Min	10.00 MHz
Max	Hardware Dependant: Option 503 = 3.6 GHz Option 504 = 3.8 GHz Option 506 = 6.00 GHz For E6640A, if license 5WC is present, the frequency range should be limited to: 1.1GHz-1.7GHz,

2.4GHz–2.5GHz, 4.8GHz–6.0GHz. If the user-defined frequency is outside of range, UI will report an error message called “Settings conflict; Frequency is outside available range”.

Initial S/W Revision      A.05.00

## Channel

The frequency of the source can be specified by a channel number of a given frequency band. This key allows you to specify the current channel number. For the appropriate range of channel numbers for a given frequency band, refer to the following tables: ["GSM/EDGE Channel Number Ranges" on page 722](#), ["W-CDMA Channel Number Ranges" on page 723](#), ["CDMA 2000 / 1xEVDO Channel Number Ranges" on page 725](#), and ["LTE FDD Channel Number Ranges" on page 727](#).

Key Path	Source, Frequency
<b>Remote Command</b>	:SOURce:FREQuency:CHANnels:NUMBer <int> :SOURce:FREQuency:CHANnels:NUMBer?
<b>Example</b>	:SOUR:FREQ:CHAN:NUMB 1
Notes	This key is grayed out when the <a href="#">"Radio Standard" on page 1392</a> is set to NONE. This key is grayed out on E6630A.
Dependencies	This key is grayed out when the <a href="#">"Radio Standard" on page 1392</a> is set to NONE. This key is grayed out on E6630A.
Couplings	The channel number is coupled to the frequency value when the <a href="#">"Radio Standard" on page 1392</a> is not set to NONE. When the frequency value is changed, the channel number will increase or decrease to match the new frequency. If the frequency is not at an exact match for a channel number, the nearest channel number is displayed along with a greater than or less than sign to indicate the frequency is above or below the channel number.
Preset	1
Min	Please refer to the tables below for the valid ranges.
Max	Please refer to the tables below for the valid ranges.
Initial S/W Revision	A.05.00

## GSM/EDGE Channel Number Ranges

Band	Link (Device)	Range	Frequency (MHz)
P-GSM	Uplink (MS)	$1 \leq n \leq 124$	$890.0 + 0.2*n$
	Downlink (BS)	$1 \leq n \leq 124$	$935.0 + 0.2*n$
E-GSM	Uplink (MS)	$0 \leq n \leq 124$	$890.0 + 0.2*n$
		$975 \leq n \leq 1023$	$890.0 + 0.2*(n-1024)$
	Downlink (BS)	$0 \leq n \leq 124$	$935.0 + 0.2*n$
		$975 \leq n \leq 1023$	$935.0 + 0.2*(n-1024)$

Band	Link (Device)	Range	Frequency (MHz)
DCS 1800	Uplink (MS)	$512 \leq n \leq 885$	$1710.200 + 0.20*(n-512)$
	Downlink (BS)	$512 \leq n \leq 885$	$1805.200 + 0.20*(n-512)$
PCS 1900	Uplink (MS)	$512 \leq n \leq 810$	$1850.200 + 0.2*(n-512)$
	Downlink (BS)	$512 \leq n \leq 810$	$1930.200 + 0.2*(n-512)$
R-GSM	Uplink (MS)	$0 \leq n \leq 124$	$890.0 + 0.2*n$
		$955 \leq n \leq 1023$	$890.0 + 0.2*(n-1024)$
	Downlink (BS)	$0 \leq n \leq 124$	$935.0 + 0.2*n$
		$955 \leq n \leq 1023$	$935.0 + 0.2*(n-1024)$
GSM 450	Uplink (MS)	$256 \leq n \leq 293$	$450.6 + 0.2*(n-259)$
	Downlink (BS)	$256 \leq n \leq 293$	$460.6 + 0.2*(n-259)$
GSM 480	Uplink (MS)	$306 \leq n \leq 340$	$479.000 + 0.20*(n-306)$
	Downlink (BS)	$306 \leq n \leq 340$	$489.000 + 0.20*(n-306)$
GSM 850	Uplink (MS)	$128 \leq n \leq 251$	$824.200 + 0.20*(n-128)$
	Downlink (BS)	$128 \leq n \leq 251$	$869.200 + 0.20*(n-128)$
GSM 700	Uplink (MS)	$438 \leq n \leq 516$	$777.200 + 0.20*(n-438)$
	Downlink (BS)	$438 \leq n \leq 516$	$747.200 + 0.20*(n-438)$
T-GSM810	Uplink (MS)	$350 \leq n \leq 425$	$806.0 + 0.20*(n-350)$
	Downlink (BS)	$350 \leq n \leq 425$	$851.0 + 0.20*(n-350)$

### W-CDMA Channel Number Ranges

Band	Link (Device)	Range	Frequency (MHz)
Band I	Downlink	$10562 \leq n \leq 10838$	$n \div 5$
	Uplink	$9612 \leq n \leq 9888$	$n \div 5$
Band II	Downlink	$412 \leq n \leq 687$	$n \div 5 + 1850.1$
		$9662 \leq n \leq 9938$	$n \div 5$
	Uplink	$12 \leq n \leq 287$	$n \div 5 + 1850.1$
		$350 \leq n \leq 425$	$n \div 5$
Band III	Downlink	$1162 \leq n \leq 1513$	$n \div 5 + 1575$
	Uplink	$937 \leq n \leq 1288$	$n \div 5 + 1525$
Band IV	Downlink	$537 \leq n \leq 1738$	$n \div 5 + 1805$
		$1887 \leq n \leq 2087$	$n \div 5 + 1735.1$
	Uplink	$1312 \leq n \leq 1513$	$n \div 5 + 1450$
		$1662 \leq n \leq 1862$	$n \div 5 + 1380.1$
Band V	Downlink	$1007 \leq n \leq 1087$	$n \div 5 + 670.1$
		$4357 \leq n \leq 4458$	$n \div 5$

Band	Link (Device)	Range	Frequency (MHz)
	Uplink	$782 \leq n \leq 862$	$n \div 5 + 670.1$
		$4132 \leq n \leq 4233$	$n \div 5$
Band VI	Downlink	$1037 \leq n \leq 1062$	$n \div 5 + 670.1$
		$4387 \leq n \leq 4413$	$n \div 5$
	Uplink	$812 \leq n \leq 837$	$n \div 5 + 670.1$
		$4162 \leq n \leq 4188$	$n \div 5$
Band VII	Downlink	$2237 \leq n \leq 2563$	$n \div 5 + 2175$
		$2587 \leq n \leq 2912$	$n \div 5 + 2105.1$
	Uplink	$2012 \leq n \leq 2338$	$n \div 5 + 2100$
		$2362 \leq n \leq 2687$	$n \div 5 + 2030.1$
Band VIII	Downlink	$2937 \leq n \leq 3088$	$n \div 5 + 340$
	Uplink	$2712 \leq n \leq 2863$	$n \div 5 + 340$
Band IX	Downlink	$9237 \leq n \leq 9387$	$n \div 5$
	Uplink	$8762 \leq n \leq 8912$	$n \div 5$
Band X	Downlink	$3112 \leq n \leq 3388$	$n \div 5 + 1490$
		$3412 \leq n \leq 3687$	$n \div 5 + 1430.1$
	Uplink	$2887 \leq n \leq 3163$	$n \div 5 + 1135$
		$3187 \leq n \leq 3462$	$n \div 5 + 1075.1$
Band XI	Downlink	$3712 \leq n \leq 3812$	$n \div 5 + 736$
	Uplink	$3487 \leq n \leq 3587$	$n \div 5 + 733$
Band XII	Downlink	$3837 \leq n \leq 3903$	$n \div 5 - 37$
		$3927 \leq n \leq 3992$	$n \div 5 - 54.9$
	Uplink	$3612 \leq n \leq 3678$	$n \div 5 - 22$
		$3702 \leq n \leq 3767$	$n \div 5 - 39.9$
Band XIII	Downlink	$4017 \leq n \leq 4043$	$n \div 5 - 55$
		$4067 \leq n \leq 4092$	$n \div 5 - 64.9$
	Uplink	$3792 \leq n \leq 3818$	$n \div 5 + 21$
		$3702 \leq n \leq 3767$	$n \div 5 - 39.9$
Band XIV	Downlink	$4117 \leq n \leq 4143$	$n \div 5 - 63$
		$4167 \leq n \leq 4192$	$n \div 5 - 72.9$
	Uplink	$3892 \leq n \leq 3918$	$n \div 5 + 12$
		$3942 \leq n \leq 3967$	$n \div 5 + 2.1$
Band XIX	Downlink	$712 \leq n \leq 763$	$n \div 5 + 735$
		$787 \leq n \leq 837$	$n \div 5 + 720.1$
	Uplink	$312 \leq n \leq 363$	$n \div 5 + 770$
		$387 \leq n \leq 437$	$n \div 5 + 755.1$



## CDMA 2000 / 1xEVDO Channel Number Ranges

Band	Link (Device)	Range	Frequency (MHz)
US Cellular	Uplink (MS, reverse link)	$1 \leq N \leq 799$	$0.030 \times N + 825.000$
		$991 \leq N \leq 1023$	$0.030 \times (N - 1023) + 825.000$
		$1024 \leq N \leq 1323$	$0.030 \times (N - 1024) + 815.040$
	Downlink (BS, forward link)	$1 \leq N \leq 799$	$0.030 \times N + 870.000$
		$991 \leq N \leq 1023$	$0.030 \times (N - 1023) + 870.000$
		$1024 \leq N \leq 1323$	$0.030 \times (N - 1024) + 860.040$
US PCS	Uplink (MS, reverse link)	$0 \leq N \leq 1199$	$1850.000 + 0.050 \times N$
	Downlink (BS, forward link)	$0 \leq N \leq 1199$	$1930.000 + 0.050 \times N$
Japan Cellular Band	Uplink (MS, reverse link)	$1 \leq N \leq 799$	$0.0125 \times (N + 915.000)$
		$801 \leq N \leq 1039$	$0.0125 \times (N - 800) + 898.000$
		$1041 \leq N \leq 1199$	$0.0125 \times (N - 1040) + 887.000$
		$1201 \leq N \leq 1600$	$0.0125 \times (N - 1200) + 893.000$
	Downlink (BS, forward link)	$1 \leq N \leq 799$	$0.0125 \times (N + 860.000)$
		$801 \leq N \leq 1039$	$0.0125 \times (N - 800) + 843.000$
		$1041 \leq N \leq 1199$	$0.0125 \times (N - 1040) + 832.000$
		$1201 \leq N \leq 1600$	$0.0125 \times (N - 1200) + 838.000$
Korean PCS Band	Uplink (MS, reverse link)	$0 \leq N \leq 599$	$0.050 \times N + 1750.000$
	Downlink (BS, forward link)	$0 \leq N \leq 599$	$0.050 \times N + 1840.000$
NMT-450 Band	Uplink (MS, reverse link)	$1 \leq N \leq 400$	$0.025 \times (N - 1) + 450.000$
		$472 \leq N \leq 871$	$0.025 \times (N - 472) + 410.000$
		$1039 \leq N \leq 1473$	$0.020 \times (N - 1024) + 451.010$
		$1536 \leq N \leq 1715$	$0.025 \times (N - 1536) + 479.000$
		$1792 \leq N \leq 2016$	$0.020 \times (N - 1792) + 479.000$
	Downlink (BS, forward link)	$1 \leq N \leq 400$	$0.025 \times (N - 1) + 460.000$
		$472 \leq N \leq 871$	$0.025 \times (N - 472) + 420.000$
		$1039 \leq N \leq 1473$	$0.020 \times (N - 1024) + 461.010$
IMT-2000 Band	Uplink (MS, reverse link)	$0 \leq N \leq 1199$	$1920.000 + 0.050 \times N$
	Downlink (BS, forward link)	$0 \leq N \leq 1199$	$2100.000 + 0.050 \times N$
Upper 700 MHz Band	Uplink (MS, reverse link)	$0 \leq N \leq 240$	$776.000 + 0.050 \times N$
	Downlink (BS, forward link)	$0 \leq N \leq 240$	$746.000 + 0.050 \times N$

Band	Link (Device)	Range	Frequency (MHz)
	forward link)		
Secondary 800 MHz Band	Uplink (MS, reverse link)	$0 \leq N \leq 719$	$0.025 \times N + 806.000$
		$720 \leq N \leq 919$	$0.025 \times (N - 720) + 896.000$
	Downlink (BS, forward link)	$0 \leq N \leq 719$	$0.025 \times N + 851.000$
		$720 \leq N \leq 919$	$0.025 \times (N - 720) + 935.000$
2.5 GHz IMT Extension	Uplink (MS, reverse link)	$0 \leq N \leq 1399$	$2500.000 + 0.050 \times N$
	Downlink (BS, forward link)	$0 \leq N \leq 1399$	$2620.000 + 0.050 \times N$
US PCS 1.9 GHz	Uplink (MS, reverse link)	$0 \leq N \leq 1299$	$1850.000 + 0.050 \times N$
	Downlink (BS, forward link)	$0 \leq N \leq 1299$	$1930.000 + 0.050 \times N$
AWS	Uplink (MS, reverse link)	$0 \leq N \leq 899$	$1710.000 + 0.050 \times N$
	Downlink (BS, forward link)	$0 \leq N \leq 899$	$2100.000 + 0.050 \times N$
US 2.5 GHz	Uplink (MS, reverse link)	$140 \leq N \leq 1459$	$2495.000 + 0.050 \times N$
	Downlink (BS, forward link)	$140 \leq N \leq 1459$	$2617.000 + 0.050 \times N$
700 Public Safety	Uplink (MS, reverse link)	$0 \leq N \leq 240$	$787.000 + 0.050 \times N$
	Downlink (BS, forward link)	$0 \leq N \leq 240$	$757.000 + 0.050 \times N$
C2K Lower 700	Uplink (MS, reverse link)	$0 \leq N \leq 360$	$698.000 + 0.050 \times N$
	Downlink (BS, forward link)	$0 \leq N \leq 360$	$728.000 + 0.050 \times N$
400 Euro PAMR	Uplink (MS, reverse link)	$1 \leq N \leq 400$	$0.025 \times (N - 1) + 450.000$
		$472 \leq N \leq 871$	$0.025 \times (N - 472) + 410.000$
	Uplink (MS, reverse link)	$1536 \leq N \leq 1715$	$0.025 \times (N - 1536) + 479.000$
	Uplink (MS, reverse link)		
	Downlink (BS, forward link)	$1 \leq N \leq 400$	$0.025 \times (N - 1) + 460.000$
		$472 \leq N \leq 871$	$0.025 \times (N - 472) + 420.000$
	Downlink (BS, forward link)	$1536 \leq N \leq 1715$	$0.025 \times (N - 1536) + 489.000$
	Downlink (BS, forward link)		

Band	Link (Device)	Range	Frequency (MHz)
800 PAMR	Uplink (MS, reverse link)	$0 \leq N \leq 239$	$870.0125 + 0.025 \times N$
	Downlink (BS, forward link)	$0 \leq N \leq 239$	$915.0125 + 0.025 \times N$

### LTE FDD Channel Number Ranges

The carrier frequency in the uplink and downlink is designated by the E-UTRA Absolute Radio Frequency Channel Number (EARFCN) in the range 0 – 65535. The relation between EARFCN and the carrier frequency in MHz for the downlink is given by the following equation, where FDL\_low and NOffs-DL are given in table 5.4.4–1 and NDL is the downlink EARFCN.

$$FDL = FDL\_low + 0.1(NDL - NOffs-DL)$$

The relation between EARFCN and the carrier frequency in MHz for the uplink is given by the following equation where FUL\_low and NOffs-UL are given in table 5.4.4–1 and NUL is the uplink EARFCN.

$$FUL = FUL\_low + 0.1(NUL - NOffs-UL)$$

Band	Downlink		Uplink			
	FDL_low (MHz)	NOffs-DL	Range of NDL	FUL_low (MHz)	NOffs-UL	Range of NUL
1		2110	0	0 – 599	1920	18000 – 18599
2		1930	600	600 – 1199	1850	18600 – 19199
3		1805	1200	1200 – 1949	1710	19200 – 19949
4		2110	1950	1950 – 2399	1710	19950 – 20399
5		869	2400	2400 – 2649	824	20400 – 20649
6		875	2650	2650 – 2749	830	20650 – 20749
7		2620	2750	2750 – 3449	2500	20750 – 20449
8		925	3450	3450 – 3799	880	21450 – 21799
9		1844.9	3800	3800 – 4149	1749.9	21800 – 22149
10		2110	4150	4150 – 4749	1710	22150 – 22749
11		1475.9	4750	4750 – 4949	1427.9	22750 – 22949

Band	Downlink	Uplink				
12	729	5010	5010 – 5179	699	23010	23010 – 23179
13	746	5180	5180 – 5279	777	23180	23180 – 23279
14	758	5280	5280 – 5379	788	23280	23280 – 23379
...						
17	734	5730	5730 – 5849	704	23730	23730 – 23849
18	860	5850	5850 – 5999	815	23850	23850 – 23999
19	875	6000	6000 – 6149	830	24000	24000 – 24149
20	791	6150	6150 – 6449	832	24150	24150 – 24449
21	1495.9	6450	6450 – 6599	1447.9	24450	24450 – 24599
...						
24	1525	7700	7700 – 8039	1626.5	25700	25700 – 26039
25	1930	8040	8040 – 8689	1850	26040	26040 – 26689
26	859	8690	8690 – 9039	814	26690	26690 – 27039
...						

Note: The channel numbers that designate carrier frequencies so close to the operating band edges that the carrier extends beyond the operating band edge shall not be used. This implies that the first 7, 15, 25, 50, 75 and 100 channel numbers at the lower operating band edge and the last 6, 14, 24, 49, 74 and 99 channel numbers at the upper operating band edge shall not be used for channel bandwidths of 1.4, 3, 5, 10, 15 and 20 MHz respectively.

### LTE TDD Channel Number Ranges

The carrier frequency in the uplink and downlink is designated by the E-UTRA Absolute Radio Frequency Channel Number (EARFCN) in the range 0 – 65535. The relation between EARFCN and the carrier frequency in MHz for the downlink is given by the following equation, where FDL\_low and NOffs-DL are given in table 5.4.4-1 and NDL is the downlink EARFCN.

$$FDL = FDL\_low + 0.1(NDL - NOffs-DL)$$

The relation between EARFCN and the carrier frequency in MHz for the uplink is given by the following equation where FUL\_low and NOffs-UL are given in table 5.4.4-1 and NUL is the uplink EARFCN.

$$FUL = FUL\_low + 0.1(NUL - NOffs-UL)$$

Band	Downlink		Uplink			
	NOffs-DL	Range of ND	FUL_low (MHz)	NOffs-UL	Range of NUL	
33	1900	36000	36000 - 36199	1900	36000	36000 - 36199
34	2010	36200	36200 - 36349	2010	36200	36200 - 36349
35	1850	36350	36350 - 36949	1850	36350	36350 - 36949
36	1930	36950	36950 - 37549	1930	36950	36950 - 37549
37	1910	37550	37550 - 37749	1910	37550	37550 - 37749
38	2570	37750	37750 - 38249	2570	37750	37750 - 38249
39	1880	38250	38250 - 38649	1880	38250	38250 - 38649
40	2300	38650	38650 - 39649	2300	38650	38650 - 39649
41	2496	39650	39650 - 41589	2496	39650	39650 - 41589
42	3400	41590	41590 - 43589	3400	41590	41590 - 43589
43	3600	43590	43590 - 45589	3600	43590	43590 - 45589

Note: The channel numbers that designate carrier frequencies so close to the operating band edges that the carrier extends beyond the operating band edge shall not be used. This implies that the first 7, 15, 25, 50, 75 and 100 channel numbers at the lower operating band edge and the last 6, 14, 24, 49, 74 and 99 channel numbers at the upper operating band edge shall not be used for channel bandwidths of 1.4, 3, 5, 10, 15 and 20 MHz respectively.

## TDSCDMA Channel Number Ranges

### 1.28 Mcps TDD Option

No TX-RX frequency separation is required as Time Division Duplex (TDD) is employed. Each subframe consists of 7 main timeslots where all main timeslots (at least the first one) before the single switching point are allocated DL and all main timeslots (at least the last one) after the single switching point are allocated UL.

The nominal channel spacing is 1.6 MHz, but this can be adjusted to optimise performance in a particular deployment scenario.

The carrier frequency is designated by the UTRA absolute radio frequency channel number (UARFCN). The value of the UARFCN in the IMT2000 band is defined in the general case as follows:

$$N_t = 5 * F \text{ 0.0 MHz } \leq F \leq 3276.6 \text{ MHz}$$

where F is the carrier frequency in MHz

Additional channels applicable to operation in the frequency band defined in sub-clause 5.2(d) are defined via the following UARFCN definition:

$$N_t = 5 * (F - 2150.1 \text{ MHz}) / 2572.5 \text{ MHz} \leq F \leq 2617.5 \text{ MHz}$$

UARFCN

1.28 Mcps TDD Option

The following UARFCN range shall be supported for each band:

**Table: UTRA Absolute Radio  
Frequency Channel Number 1.28  
Mcps TDD Option**

Frequency Band	Frequency Range	UARFCN Uplink and Downlink transmission
For operation in frequency band as defined in subclause 5.2 (a)	1900-1920 MHz	9504 to 9596
	2010-2025 MHz	10054 to 10121
For operation in frequency band as defined in subclause 5.2 (b)	1850-1910 MHz	9254 to 9546
	1930-1990 MHz	9654 to 9946
For operation in frequency band as defined in subclause 5.2 (c)	1910-1930 MHz	9554 to 9646
For operation in frequency band as defined in subclause 5.2 (d)	2570-2620 MHz	12854 to 13096
For operation in frequency band as defined in subclause 5.2 (e)	2300-2400 MHz	11504 to 11996
For operation in frequency band as defined in subclause 5.2 (f)	1880-1920 MHz	9404 to 9596

## Radio Setup

Allows access to the sub-menus for selecting the radio standard and associated radio band. You can also set a frequency reference and offset.

This menu is greyed out when on E6630A. Radio band settings for GSM, cdma2000, and so on -- most of which are not actually supported in E6630A, which has three narrow frequency bands. So band settings are grayed out.

Key Path	Source, Frequency
Initial S/W Revision	A.05.00

## Radio Standard

Allows access to the channel band sub-menus to select the desired radio standard. When you have selected the radio standard, you can then set an active channel band. The radio standard and the active

channel band allow you to use channel numbers to set frequency automatically.

Key Path	Source, Frequency, Radio Setup
<b>Remote Command</b>	:SOURce:FREQuency:CHANnels:BAND NONE   PGSM   EGSM   RGSM   DCS1800   PCS1900   TGSM810   GSM450   GSM480   GSM700   GSM850   BANDI   BANDII   BANDIII   BANDIV   BANDV   BANDVI   BANDVII   BANDVIII   BANDIX   BANDX   BANDXI   BANDXII   BANDXIII   BANDXIV   BANDXIX   USCELL   USPCS   JAPAN   KOREAN   NMT   IMT2K   UPPER   SECOND   PAMR400   PAMR800   IMTEXT   PCS1DOT9G   AWS   US2DOT5G   PUBLIC   LOWER   BAND1   BAND2   BAND3   BAND4   BAND5   BAND6   BAND7   BAND8   BAND10   BAND11   BAND12   BAND13   BAND14   BAND17   BAND18   BAND19   BAND20   BAND21   BAND24   BAND25   BAND26   BAND27   BAND28   BAND29   BAND30   BAND31   BAND33   BAND34   BAND35   BAND36   BAND37   BAND38   BAND39   BAND40   BAND41   BAND42   BAND43   BAND44   BANDA   BANDB   BANDC   BANDD   BANDE   BANDF  :SOURce:FREQuency:CHANnels:BAND?
<b>Example</b>	:SOUR:FREQ:CHAN:BAND PGSM
<b>Notes</b>	Set this setting to "NONE" will grey out "Channel" on page 1384 Channel
Initial S/W Revision	A.05.00

#### None

Selects no radio standard for use. When you have selected the radio standard to NONE, you cannot use channel numbers to set frequency automatically. You will need to set the frequency manually.

Key Path	Source, Frequency, Radio Setup, Radio Standard
Initial S/W Revision	A.05.00

#### GSM/EDGE

Sets GSM/EDGE as the radio standard for use and accesses the GSM/EDGE specific channel band sub-menus.

Key Path	Source, Frequency, Radio Setup, Radio Standard
Initial S/W Revision	A.05.00

#### P-GSM

Selects P-GSM as the active channel band.

Key Path	Source, Frequency, Radio Setup, Radio Standard, GSM/EDGE
<b>Example</b>	:SOUR:FREQ:CHAN:BAND PGSM
Initial S/W Revision	A.05.00

### E-GSM

Selects E-GSM as the active channel band.

Key Path	Source, Frequency, Radio Setup, Radio Standard, GSM/EDGE
<b>Example</b>	:SOUR:FREQ:CHAN:BAND EGSM
Initial S/W Revision	A.05.00

### R-GSM

Selects R-GSM as the active channel band.

Key Path	Source, Frequency, Radio Setup, Radio Standard, GSM/EDGE
<b>Example</b>	:SOUR:FREQ:CHAN:BAND RGSM
Initial S/W Revision	A.05.00

### DCS 1800

Selects DCS 1800 as the active channel band.

Key Path	Source, Frequency, Radio Setup, Radio Standard, GSM/EDGE
<b>Example</b>	:SOUR:FREQ:CHAN:BAND DCS1800
Initial S/W Revision	A.05.00

### PCS 1900

Selects PCS 1900 as the active channel band.

Key Path	Source, Frequency, Radio Setup, Radio Standard, GSM/EDGE
<b>Example</b>	:SOUR:FREQ:CHAN:BAND PCS1900
Initial S/W Revision	A.05.00

### GSM 450

Selects GSM 450 as the active channel band.

Key Path	Source, Frequency, Radio Setup, Radio Standard, GSM/EDGE
<b>Example</b>	:SOUR:FREQ:CHAN:BAND GSM450
Initial S/W Revision	A.05.00



**GSM 480**

Selects GSM 480 as the active channel band.

Key Path	Source, Frequency, Radio Setup, Radio Standard, GSM/EDGE
<b>Example</b>	:SOUR:FREQ:CHAN:BAND GSM480
Initial S/W Revision	A.05.00

**GSM 850**

Selects GSM 850 as the active channel band.

Key Path	Source, Frequency, Radio Setup, Radio Standard, GSM/EDGE
<b>Example</b>	:SOUR:FREQ:CHAN:BAND GSM850
Initial S/W Revision	A.05.00

**GSM 700**

Selects GSM 700 as the active channel band.

Key Path	Source, Frequency, Radio Setup, Radio Standard, GSM/EDGE
<b>Example</b>	:SOUR:FREQ:CHAN:BAND GSM700
Initial S/W Revision	A.05.00

**T-GSM 810**

Selects T-GSM 810 as the active channel band.

Key Path	Source, Frequency, Radio Setup, Radio Standard, GSM/EDGE
<b>Example</b>	:SOUR:FREQ:CHAN:BAND T-GSM810
Initial S/W Revision	A.05.00

**WCDMA**

Sets WCDMA as the radio standard for use and accesses the W-CDMA specific channel band sub-menus.

Key Path	Source, Frequency, Radio Setup, Radio Standard
Initial S/W Revision	A.05.00

**Band I**

Selects Band I as the active channel band.

---

Key Path	Source, Frequency, Radio Setup, Radio Standard, WCDMA
<b>Example</b>	:SOUR:FREQ:CHAN:BAND BANDI
Initial S/W Revision	A.05.00

---

#### Band II

Selects Band II as the active channel band.

---

Key Path	Source, Frequency, Radio Setup, Radio Standard, WCDMA
<b>Example</b>	:SOUR:FREQ:CHAN:BAND BANDII
Initial S/W Revision	A.05.00

---

#### Band III

Selects Band III as the active channel band.

---

Key Path	Source, Frequency, Radio Setup, Radio Standard, WCDMA
<b>Example</b>	:SOUR:FREQ:CHAN:BAND BANDIII
Initial S/W Revision	A.05.00

---

#### Band IV

Selects Band IV as the active channel band.

---

Key Path	Source, Frequency, Radio Setup, Radio Standard, WCDMA
<b>Example</b>	:SOUR:FREQ:CHAN:BAND BANDIV
Initial S/W Revision	A.05.00

---

#### Band V

Selects Band V as the active channel band.

---

Key Path	Source, Frequency, Radio Setup, Radio Standard, WCDMA
<b>Example</b>	:SOUR:FREQ:CHAN:BAND BANDV
Initial S/W Revision	A.05.00

---

#### Band VI

Selects Band VI as the active channel band.

Key Path	Source, Frequency, Radio Setup, Radio Standard, WCDMA
<b>Example</b>	:SOUR:FREQ:CHAN:BAND BANDVI
Initial S/W Revision	A.05.00

**Band VII**

Selects Band VII as the active channel band.

Key Path	Source, Frequency, Radio Setup, Radio Standard, WCDMA
<b>Example</b>	:SOUR:FREQ:CHAN:BAND BANDVII
Initial S/W Revision	A.05.00

**Band VIII**

Selects Band VIII as the active channel band.

Key Path	Source, Frequency, Radio Setup, Radio Standard, WCDMA
<b>Example</b>	:SOUR:FREQ:CHAN:BAND BANDVIII
Initial S/W Revision	A.05.00

**Band IX**

Selects Band IX as the active channel band.

Key Path	Source, Frequency, Radio Setup, Radio Standard, WCDMA
<b>Example</b>	:SOUR:FREQ:CHAN:BAND BANDIX
Initial S/W Revision	A.05.00

**Band X**

Selects Band X as the active channel band.

Key Path	Source, Frequency, Radio Setup, Radio Standard, WCDMA
<b>Example</b>	:SOUR:FREQ:CHAN:BAND BANDX
Initial S/W Revision	A.05.00

**Band XI**

Selects Band XI as the active channel band.

---

Key Path	Source, Frequency, Radio Setup, Radio Standard, WCDMA
<b>Example</b>	:SOUR:FREQ:CHAN:BAND BANDXI
Initial S/W Revision	A.05.00

---

#### Band XII

Selects Band XII as the active channel band.

---

Key Path	Source, Frequency, Radio Setup, Radio Standard, WCDMA
<b>Example</b>	:SOUR:FREQ:CHAN:BAND BANDXII
Initial S/W Revision	A.05.00

---

#### Band XIII

Selects band XIII as the active channel band.

---

Key Path	Source, Frequency, Radio Setup, Radio Standard, WCDMA
<b>Example</b>	:SOUR:FREQ:CHAN:BAND BANDXIII
Initial S/W Revision	A.05.00

---

#### Band XIV

Selects Band XIV as the active channel band.

---

Key Path	Source, Frequency, Radio Setup, Radio Standard, WCDMA
<b>Example</b>	:SOUR:FREQ:CHAN:BAND BANDXIV
Initial S/W Revision	A.05.00

---

#### LTE

Sets LTE FDD as the radio standard for use and accesses the LTE FDD specific channel band sub-menus..

---

Key Path	Source, Frequency, Radio Setup, Radio Standard
Initial S/W Revision	A.09.50

---

#### BAND 1

Selects BAND 1 as the band for the current step.

---

Key Path	Source, Frequency, Radio Setup, Radio Standard, LTE
----------	-----------------------------------------------------

---

<b>Example</b>	:SOUR:FREQ:CHAN:BAND BAND1
Initial S/W Revision	A.09.50

**BAND 2**

Selects BAND 2 as the band for the current step.

Key Path	Source, Frequency, Radio Setup, Radio Standard, LTE
<b>Example</b>	:SOUR:FREQ:CHAN:BAND BAND2
Initial S/W Revision	A.09.50

**BAND 3**

Selects BAND 3 as the band for the current step.

Key Path	Source, Frequency, Radio Setup, Radio Standard, LTE
<b>Example</b>	:SOUR:FREQ:CHAN:BAND BAND3
Initial S/W Revision	A.09.50

**BAND 4**

Selects BAND 4 as the band for the current step.

Key Path	Source, Frequency, Radio Setup, Radio Standard, LTE
<b>Example</b>	:SOUR:FREQ:CHAN:BAND BAND4
Initial S/W Revision	A.09.50

**BAND 5**

Selects BAND 5 as the band for the current step.

Key Path	Source, Frequency, Radio Setup, Radio Standard, LTE
<b>Example</b>	:SOUR:FREQ:CHAN:BAND BAND5
Initial S/W Revision	A.09.50

**BAND 6**

Selects BAND 6 as the band for the current step.

Key Path	Source, Frequency, Radio Setup, Radio Standard, LTE
----------	-----------------------------------------------------

---

<b>Example</b>	:SOUR:FREQ:CHAN:BAND BAND6
Initial S/W Revision	A.09.50

---

#### BAND 7

Selects BAND 7 as the band for the current step.

---

Key Path	Source, Frequency, Radio Setup, Radio Standard, LTE
<b>Example</b>	:SOUR:FREQ:CHAN:BAND BAND7
Initial S/W Revision	A.09.50

---

#### BAND 8

Selects BAND 8 as the band for the current step.

---

Key Path	Source, Frequency, Radio Setup, Radio Standard, LTE
<b>Example</b>	:SOUR:FREQ:CHAN:BAND BAND8
Initial S/W Revision	A.09.50

---

#### BAND 9

Selects BAND 9 as the band for the current step.

---

Key Path	Source, Frequency, Radio Setup, Radio Standard, LTE
<b>Example</b>	:SOUR:FREQ:CHAN:BAND BAND9
Initial S/W Revision	A.09.50

---

#### BAND 10

Selects BAND 10 as the band for the current step.

---

Key Path	Source, Frequency, Radio Setup, Radio Standard, LTE
<b>Example</b>	:SOUR:FREQ:CHAN:BAND BAND10
Initial S/W Revision	A.09.50

---

#### BAND 11

Selects BAND 11 as the band for the current step.

---

Key Path	Source, Frequency, Radio Setup, Radio Standard, LTE
----------	-----------------------------------------------------

---

<b>Example</b>	:SOUR:FREQ:CHAN:BAND BAND11
Initial S/W Revision	A.09.50

**BAND 12**

Selects BAND 12 as the band for the current step.

Key Path	Source, Frequency, Radio Setup, Radio Standard, LTE
<b>Example</b>	:SOUR:FREQ:CHAN:BAND BAND12
Initial S/W Revision	A.09.50

**BAND 13**

Selects BAND 13 as the band for the current step.

Key Path	Source, Frequency, Radio Setup, Radio Standard, LTE
<b>Example</b>	:SOUR:FREQ:CHAN:BAND BAND13
Initial S/W Revision	A.09.50

**BAND 14**

Selects BAND 14 as the band for the current step.

Key Path	Source, Frequency, Radio Setup, Radio Standard, LTE
<b>Example</b>	:SOUR:FREQ:CHAN:BAND BAND14
Initial S/W Revision	A.09.50

**BAND 17**

Selects BAND 17 as the band for the current step.

Key Path	Source, Frequency, Radio Setup, Radio Standard, LTE
<b>Example</b>	:SOUR:FREQ:CHAN:BAND BAND17
Initial S/W Revision	A.09.50

**BAND 18**

Selects BAND 18 as the band for the current step.

Key Path	Source, Frequency, Radio Setup, Radio Standard, LTE
----------	-----------------------------------------------------

---

<b>Example</b>	:SOUR:FREQ:CHAN:BAND BAND18
Initial S/W Revision	A.09.50

---

#### BAND 19

Selects BAND 19 as the band for the current step.

---

Key Path	Source, Frequency, Radio Setup, Radio Standard, LTE
<b>Example</b>	:SOUR:FREQ:CHAN:BAND BAND19
Initial S/W Revision	A.09.50

---

#### BAND 20

Selects BAND 20 as the band for the current step.

---

Key Path	Source, Frequency, Radio Setup, Radio Standard, LTE
<b>Example</b>	:SOUR:FREQ:CHAN:BAND BAND20
Initial S/W Revision	A.09.50

---

#### BAND 21

Selects BAND 21 as the band for the current step.

---

Key Path	Source, Frequency, Radio Setup, Radio Standard, LTE
<b>Example</b>	:SOUR:FREQ:CHAN:BAND BAND21
Initial S/W Revision	A.09.50

---

#### BAND 24

Selects BAND 24 as the band for the current step.

---

Key Path	Source, Frequency, Radio Setup, Radio Standard, LTE
<b>Example</b>	:SOUR:FREQ:CHAN:BAND BAND24
Initial S/W Revision	A.09.50

---

#### BAND 25

Selects BAND 25 as the band for the current step.

---

Key Path	Source, Frequency, Radio Setup, Radio Standard, LTE
----------	-----------------------------------------------------

---



<b>Example</b>	:SOUR:FREQ:CHAN:BAND BAND25
Initial S/W Revision	A.09.50

**BAND 26**

Selects BAND 26 as the band for the current step.

Key Path	Source, Frequency, Radio Setup, Radio Standard, LTE
<b>Example</b>	:SOUR:FREQ:CHAN:BAND BAND26
Initial S/W Revision	A.12.53

**BAND 27**

Selects BAND 27 as the band for the current step.

Key Path	Source, Frequency, Radio Setup, Radio Standard, LTE
<b>Example</b>	:SOUR:FREQ:CHAN:BAND BAND27
Initial S/W Revision	A.14.00

**BAND 28**

Selects BAND 28 as the band for the current step.

Key Path	Source, Frequency, Radio Setup, Radio Standard, LTE
<b>Example</b>	:SOUR:FREQ:CHAN:BAND BAND28
Initial S/W Revision	A.14.00

**BAND 31**

Selects BAND 31 as the band for the current step.

Key Path	Source, Frequency, Radio Setup, Radio Standard, LTE
<b>Example</b>	:SOUR:FREQ:CHAN:BAND BAND31
Initial S/W Revision	A.14.00

**LTE TDD**

Sets LTE TDD as the radio standard for use and accesses the LTE TDD specific channel band sub-menus..

Key Path	Source, Frequency, Radio Setup, Radio Standard
Initial S/W Revision	A.11.50

### BAND 33

Selects BAND 33 as the band for the current step.

Key Path	Source, Frequency, Radio Setup, Radio Standard, LTE TDD
<b>Example</b>	:SOUR:FREQ:CHAN:BAND BAND33
Initial S/W Revision	A.11.50

### BAND 34

Selects BAND 34 as the band for the current step.

Key Path	Source, Frequency, Radio Setup, Radio Standard, LTE TDD
<b>Example</b>	:SOUR:FREQ:CHAN:BAND BAND34
Initial S/W Revision	A.11.50

### BAND 35

Selects BAND 35 as the band for the current step.

Key Path	Source, Frequency, Radio Setup, Radio Standard, LTE TDD
<b>Example</b>	:SOUR:FREQ:CHAN:BAND BAND35
Initial S/W Revision	A.11.50

### BAND 36

Selects BAND 36 as the band for the current step.

Key Path	Source, Frequency, Radio Setup, Radio Standard, LTE TDD
<b>Example</b>	:SOUR:FREQ:CHAN:BAND BAND36
Initial S/W Revision	A.11.50

### BAND 37

Selects BAND 37 as the band for the current step.

Key Path	Source, Frequency, Radio Setup, Radio Standard, LTE TDD
<b>Example</b>	:SOUR:FREQ:CHAN:BAND BAND37
Initial S/W Revision	A.11.50

**BAND 38**

Selects BAND 38 as the band for the current step.

Key Path	Source, Frequency, Radio Setup, Radio Standard, LTE TDD
<b>Example</b>	:SOUR:FREQ:CHAN:BAND BAND38
Initial S/W Revision	A.11.50

**BAND 39**

Selects BAND 39 as the band for the current step.

Key Path	Source, Frequency, Radio Setup, Radio Standard, LTE TDD
<b>Example</b>	:SOUR:FREQ:CHAN:BAND BAND39
Initial S/W Revision	A.11.50

**BAND 40**

Selects BAND 40 as the band for the current step.

Key Path	Source, Frequency, Radio Setup, Radio Standard, LTE TDD
<b>Example</b>	:SOUR:FREQ:CHAN:BAND BAND40
Initial S/W Revision	A.11.50

**BAND 41**

Selects BAND 41 as the band for the current step.

Key Path	Source, Frequency, Radio Setup, Radio Standard, LTE TDD
<b>Example</b>	:SOUR:FREQ:CHAN:BAND BAND41
Initial S/W Revision	A.11.50

**BAND 42**

Selects BAND 42 as the band for the current step.

Key Path	Source, Frequency, Radio Setup, Radio Standard, LTE TDD
<b>Example</b>	:SOUR:FREQ:CHAN:BAND BAND42
Initial S/W Revision	A.11.50

### BAND 43

Selects BAND 43 as the band for the current step.

Key Path	Source, Frequency, Radio Setup, Radio Standard, LTE TDD
<b>Example</b>	:SOUR:FREQ:CHAN:BAND BAND43
Initial S/W Revision	A.11.50

### BAND 44

Selects BAND 44 as the band for the current step.

Key Path	Source, Frequency, Radio Setup, Radio Standard, LTE TDD
<b>Example</b>	:SOUR:FREQ:CHAN:BAND BAND44
Initial S/W Revision	A.14.00

### TDSCDMA

Sets TDSCDMA as the radio standard for use and accesses the TDSCDMA specific channel band sub-menus..

Key Path	Source, Frequency, Radio Setup, Radio Standard
Initial S/W Revision	A.11.50

### BAND A

Selects BAND A as the band for the current step.

Key Path	Source, Frequency, Radio Setup, Radio Standard, TDSCDMA
<b>Example</b>	:SOUR:FREQ:CHAN:BAND BANDA
Initial S/W Revision	A.11.50

### BAND B

Selects BAND B as the band for the current step.

Key Path	Source, Frequency, Radio Setup, Radio Standard, TDSCDMA
<b>Example</b>	:SOUR:FREQ:CHAN:BAND BANDB
Initial S/W Revision	A.11.50

### BAND C

Selects BAND C as the band for the current step.

Key Path	Source, Frequency, Radio Setup, Radio Standard, TDSCDMA
<b>Example</b>	:SOUR:FREQ:CHAN:BAND BANDC
Initial S/W Revision	A.11.50

**BAND D**

Selects BAND D as the band for the current step.

Key Path	Source, Frequency, Radio Setup, Radio Standard, TDSCDMA
<b>Example</b>	:SOUR:FREQ:CHAN:BAND BANDD
Initial S/W Revision	A.11.50

**BAND E**

Selects BAND E as the band for the current step.

Key Path	Source, Frequency, Radio Setup, Radio Standard, TDSCDMA
<b>Example</b>	:SOUR:FREQ:CHAN:BAND BANDE
Initial S/W Revision	A.11.50

**BAND F**

Selects BAND F as the band for the current step.

Key Path	Source, Frequency, Radio Setup, Radio Standard, TDSCDMA
<b>Example</b>	:SOUR:FREQ:CHAN:BAND BANDF
Initial S/W Revision	A.11.50

**Radio Band Link**

Allows you to specify the channel band type as either uplink or downlink link direction. This value is used in conjunction with the channel band and channel number to determine the absolute frequency output by the source. When set to "Uplink", the source will calculate the uplink frequency using an uplink formula together with the selected channel band and channel number. When set to "Downlink", the source will calculate the downlink frequency using a downlink formula together with the selected channel band and channel number.

Key Path	Source, Frequency, Radio Setup
<b>Remote Command</b>	:SOURce:RADio:BAND:LINK DOWN UP :SOURce:RADio:BAND:LINK?

<b>Example</b>	:SOUR:RAD:BAND:LINK UP
<b>Preset</b>	DOWN
<b>Range</b>	DOWN   UP
<b>Backwards Compatibility SCPI</b>	:SOURce:RADio:DEVIce BTS MS :SOURce:RADio:DEVIce?
<b>Backwards Compatibility Notes</b>	BTS maps to the Downlink frequency MS maps to the Uplink frequency
<b>Initial S/W Revision</b>	A.05.00

### Set Reference Frequency

This key allows you to set the frequency reference. Pressing this key turns the frequency reference state to ON, sets the reference frequency value to the current frequency, maintains this frequency at the RF output, and sets the displayed frequency to 0.00 Hz. All subsequent frequencies entered under Source>Frequency>Frequency are interpreted as being relative to this reference frequency.

When you use a frequency reference, the signal generator outputs a frequency that is set relative to the reference frequency by the value entered under Source>Frequency>Frequency as follows:

Output frequency = reference frequency - entered frequency

Where:

reference frequency equals the original RF frequency entered under Source>Frequency>Frequency and set as the reference frequency

entered frequency equals a new value entered under Source>Frequency>Frequency

In addition, the displayed frequency value will be the same as the value entered under Source>Frequency>Frequency.

**NOTE**

If Freq Reference is set to ON with a reference value set, entering a value under Source>Frequency>Frequency and pressing Set Frequency Reference will add that value to the existing Freq Reference value.

If you wish to change the reference frequency value to the new value entered under Source>Frequency>Frequency, first you must set Freq Reference to OFF and then press Set Frequency Reference.

<b>Key Path</b>	Source, Frequency
<b>Remote Command</b>	:SOURce:FREQuency:REFerence:SET
<b>Example</b>	:SOUR:FREQ:REF:SET
<b>Dependencies</b>	This setting is unavailable, and is grayed out when the List Sequencer is turned ON.
<b>Initial S/W Revision</b>	A.05.00

## Freq Reference

This key allows you to toggle the state of the frequency reference. When the frequency reference state is ON, an annunciator is displayed on the main source view to indicate this state to the user.

When you use a frequency reference, the signal generator outputs a frequency that is set relative to the reference frequency by the value entered under Source>Frequency>Frequency as follows:

Output frequency = reference frequency + entered frequency

Where:

reference frequency equals the original RF frequency entered under Source>Frequency>Frequency and set as the reference frequency

entered frequency equals a new value entered under Source>Frequency>Frequency

For more information on Reference Frequency refer to ["Set Reference Frequency" on page 1408](#)

Key Path	Source, Frequency
<b>Remote Command</b>	:SOURce:FREQuency:REFerence <freq> :SOURce:FREQuency:REFerence? :SOURce:FREQuency:REFerence:STATe OFF ON 0 1 :SOURce:FREQuency:REFerence:STATe?
<b>Example</b>	:SOUR:FREQ:REF 0.00 Hz :SOUR:FREQ:REF:STATe ON
Dependencies	This setting is unavailable, and is grayed out when the List Sequencer is turned ON.
Couplings	The frequency reference state is coupled to the frequency reference set immediate action. When the reference set immediate action key is pressed, or the SCPI command issued, it turns the frequency reference state ON.
Preset	0.00 Hz OFF
Min	0.00 Hz
Max	Hardware Dependant: Option 503 = 3.6 GHz Option 504 = 3.8 GHz Option 506 = 6.00 GHz
Initial S/W Revision	A.05.00

## Freq Offset

Allows you to specify the frequency offset value. When the frequency offset state is ON, an annunciator is displayed on the main source view to indicate this state to the user.

When the frequency offset is set to zero (0) and you set a new offset value, the displayed frequency value will change as follows and the RF output frequency will not change:

Displayed value = output frequency + offset value

Where:

output frequency equals the original frequency entered under Source>Frequency>Frequency

offset value equals the value entered under Source>Frequency>Freq Offset

When the frequency offset is set to a value other than zero (0) and you enter a new frequency value under Source>Frequency>Frequency, the displayed frequency will be the same as the value entered and the RF output frequency will be equal to the value entered minus the offset value as follows:

Output frequency = entered frequency – offset frequency

Displayed frequency = output frequency + offset frequency

Displayed frequency = entered frequency

Where:

entered frequency equals the frequency entered under Source>Frequency>Frequency

offset frequency equals the value previously entered and set under Source>Frequency>Freq Offset

Key Path	Source, Frequency
Remote Command	:SOURce:FREQuency:OFFSet <freq> :SOURce:FREQuency:OFFSet?
Example	:SOUR:FREQ:OFFS 0 Hz
Dependencies	This setting is unavailable, and is grayed out when the List Sequencer is turned ON.
Preset	0 Hz
Min	-100.00 GHz
Max	100.00 GHz
Initial S/W Revision	A.05.00

## Modulation Setup

Allows access to the menus for setting up the available modulation types: "ARB" on page 1424, "AM" on page 1445, "FM" on page 1446, and "PM" on page 1448.

Key Path	Source
Initial S/W Revision	A.05.00

## ARB

Allows you access to the ARB sub-menus.

Key Path	Source, Modulation Setup
Initial S/W Revision	A.05.00



## ARB

Allows you to toggle the state of the ARB function. When the ARB is On, a “MOD” annunciator is displayed in the system settings panel. When the ARB is turned Off, the MOD annunciator is cleared

Key Path	Source, Modulation Setup, ARB
Remote Command	:SOURce:RADio:ARB[:STATe] ON OFF 1 0 :SOURce:RADio:ARB[:STATe]?
Example	:SOUR:RAD:ARB OFF :SOUR:RAD:ARB?
Notes	If the ARB is ON, a user then loads or deletes another file to ARB memory, the playing waveform segment may not keep phase continuity during the ARB memory operation. The waveform will be replayed after the ARB operation is finished.
Dependencies	This setting is for independent mode and has no effect on 3.3.8 list sequencer mode. Setting <b>"Sequencer" on page 1449</b> Sequencer to On will put source enter list sequencer mode, and even if ARB state is On, the ARB file will not be played. Setting <b>"Sequencer" on page 1449</b> Sequencer to Off will make source leave list sequencer mode, and this setting will take effect immediately. The ARB can only be turned on when there is a waveform file selected for playback. On the GUI If no waveform is selected, this key is grayed out. If you send the SCPI command to turn the ARB on with no waveform selected for playback, the ARB state remains OFF and an error is generated. "- When you try to recall a certain set of states in which the selected waveform is not in ARB memory and the ARB state is On, errors are reported
Preset	Off
Range	On   Off
Initial S/W Revision	A.05.00

## Select Waveform

Allows you to access to the waveform selection sub-menus.

Pressing this key changes the central view area to show the Waveform File Selection view.

Key Path	Source, Modulation Setup, ARB
Initial S/W Revision	A.05.00

## Select Waveform

Allows you to select a waveform sequence or segment for the dual ARB to play.

NOTE: Selecting a waveform file does not result in automatic adjustments to burst timing (to compensate for the presence or absence of a Multiport Adapter); that adjustment occurs only when a waveform is loaded to ARB memory. See "Load Segment to ARB Memory" for more information about this adjustment.

<b>Key Path</b>	Source, Modulation Setup, ARB, Select Waveform
<b>Remote Command</b>	:SOURCE:RADio:ARB:WAVEform <string> :SOURCE:RADio:ARB:WAVEform?
<b>Example</b>	:SOUR:RAD:ARB:WAV "test_waveform.bin"
<b>Notes</b>	<p>If intended waveform is not in the memory yet, then issuing this command by SCPI will invoke ARB loading operation first, which involves a delay of unpredictable length. So this command should be followed by the query *OPC?, which holds off subsequent commands until the loading operation is complete.</p> <p>&lt;string&gt; - specifies the name of the waveform segment or waveform sequence to be played by the ARB.</p> <p>When in Sequence Analyzer mode, and Include Source is Yes, if the you attempt to play a waveform sequence but not all the required waveform segments are in the ARB playback memory, the application will reject the loading operation with an error is generated .</p> <p>When Include Source is No, if you attempt to play a waveform sequence but not all the required waveform segments are contained in the ARB playback memory, the application will attempt to load the required segments from either the default directory of the current directory. If the ARB memory does not have enough space for all the waveform segments to be loaded, an error is generated and none of the waveform segments is loaded.</p> <p>If the ARB is ON, and you attempt to play a waveform sequence but not all the waveform segments within the sequence could be found to be loaded into ARB memory, an error is generated. The selected waveform keeps the previous value and ARB state remains On.</p> <p>If you specify a waveform segment over SCPI but the waveform segment is not present within ARB playback memory and cannot be found for auto loading within the current directory or the default directory, an error is generated and the file selection remains unchanged.</p> <p>If you select a waveform for playback and the waveform requires a license that is not installed on the instrument, an error is generated. error is generated.</p> <p>If the ARB is ON and you load a file to ARB memory or delete a file from ARB memory, the playing waveform segment may not keep phase continuity during the ARB memory operation. The waveform will be replayed after the ARB operation is finished.</p>
<b>Initial S/W Revision</b>	A.05.00

### Segments on Hard Disk

Allows you access to the sub-menus for loading waveform segments from the hard disk into ARB memory. The default directory is: D: varb.

Pressing this key changes the current view to the Waveform Management View.

<b>Key Path</b>	Source, Modulation Setup, ARB, Select Waveform
<b>Initial S/W Revision</b>	A.05.00

### Load Segment To ARB Memory

Allows you to load the selected file into ARB memory. On the front panel you select the file for loading to the ARB memory by highlighting the desired file in the list. Using the SCPI command, you specify the file

name on the HDD.

“NVWFM” (none-volatile storage) MSUS (Mass Storage Unit Specifier) is supported in the memory subsystem because the ARB memory cannot be accessed directly. Therefore, files must be downloaded to the instrument hard disk and then loaded into the ARB memory. “NVWFM” MSUS will be mapped to the default directory D: VARB. The SCPI command supports using either “NVWFM” MSUS or specifying a full path. For more information, see Memory Subsystem (Remote Command Only).

If a file of the same name already exists within ARB memory, it is overwritten. If you wish to load two segments of the same name, you must rename one of the segments before loading it into ARB memory. To rename a segment, you can either use Windows File Explorer, or the :MMEMory:COpy command.

NOTE: When a waveform file is loaded to ARB memory, burst timing adjustments are made automatically, based on whether or not a Multiport Adapter is connected to the test set and powered on. If the connection/power status of the Multiport Adapter is changed after a waveform file has been loaded, it needs to be loaded again.

<b>Key Path</b>	Source, Modulation Setup, ARB, Select Waveform, Segments on Hard Disk
<b>Remote Command</b>	:SOURce:RADio:ARB:LOAD <string>
<b>Example</b>	:SOUR:RAD:ARB:LOAD "D: VARB\testwaveform.bin" or :SOUR:RAD:ARB:LOAD "NVWFM:testwaveform.bin"
<b>Notes</b>	<p>Because loading the file involves a delay of unpredictable length, this command should be followed by the query *OPC?, which holds off subsequent commands until the loading operating is complete.</p> <p>&lt;string&gt; – specifies the path name of the file to load from the HDD into ARB memory. It could be a &lt;full path + filename&gt;, or &lt;“NVWFM” MSUS + colon + filename&gt;.</p> <p>When in Sequence Analyzer mode, and Include Source is Yes, an attempt to load a file to ARB memory will be rejected with an error.</p> <p>When Include Source is No and if there is insufficient free ARB memory to load the selected waveform, an error is generated. .</p> <p>If you specify a file over SCPI, but the file is not at the specified location, an error is generated.</p> <p>If you try to load a waveform file but the file contains less than 500 IQ samples, an error is generated.</p> <p>If you try to load a Signal Studio waveform “*.wfm” which contains invalid waveform header, an error is generated.</p> <p>If the ARB is ON when you load a file to ARB memory or delete a file from ARB memory, the playing waveform segment may not keep phase continuity during the ARB memory operation. The waveform will be replayed after the ARB operation is finished.</p> <p>ARB can be loaded into ARB memory even required licenses do not present on the instrument. In this case, a GUI only warning message -800, “Operation complete; Loaded &lt;filename&gt; successfully, but no license &lt;required licenses&gt; installed”. User can install required licenses according to &lt;required licenses&gt; string to license it, or multi-pack license it.</p>
<b>Initial S/W Revision</b>	A.05.00

### Load All To ARB Memory

Allows you to load all the segment files within the currently selected directory into ARB memory. If a file of the same name already exists within ARB memory, it is overwritten. If you wish to load two segments of the

same name, you must rename one of the segments before loading it into ARB memory. To rename a segment, you can either use Windows File Explorer, or the :MEMory:COpy command.

NOTE: When a waveform file is loaded to ARB memory, burst timing adjustments are made automatically, based on whether or not a Multiport Adapter is connected to the test set and powered on. If the connection/power status of the Multiport Adapter is changed after a waveform file has been loaded, it needs to be loaded again.

<b>Key Path</b>	Source, Modulation Setup, ARB, Select Waveform, Segments on Hard Disk
<b>Remote Command</b>	:SOURce:RADio:ARB:LOAD:ALL <string>
<b>Example</b>	:SOUR:RAD:ARB:LOAD:ALL "D: varb"
<b>Notes</b>	<p>&lt;string&gt; - specifies the directory on the HDD to load the files into ARB memory from.</p> <p>When in Sequence Analyzer mode, and Include Source is Yes, an attempt to load all files from a directory to ARB memory is rejected with an error.</p> <p>When Include Source is No and there is insufficient free ARB memory to load all the waveforms, when the ARB memory is full, the copy ceases, and an error is generated.</p> <p>If you specify a directory over SCPI, but the directory does not exist, an error is generated.</p> <p>If the ARB is ON, a user then loads or deletes file to ARB memory, the playing waveform segment may not keep phase continuity during the ARB memory operation. The waveform will be replayed after the ARB operation is finished.</p>
<b>Initial S/W Revision</b>	A.05.00

#### Change Directory...

Allows you to change the currently selected directory on the hard disk. Pressing this key opens a standard windows change directory dialog allowing you to select the new directory of interest.

The current directory is used for manually loading waveform segments into ARB memory for playback, and as a search location for waveform segments that are required to be loaded into ARB memory for playback of a waveform sequence or a list sequence.

<b>Key Path</b>	Source, Modulation Setup, ARB, Select Waveform, Segments on Hard Disk
<b>Notes</b>	No remote command, SCPIfront panel only.
<b>Initial S/W Revision</b>	A.05.00

#### Default Directory...

Allows you to change the default directory. It is used as a search location for waveform segments that are required to be loaded into ARB memory for playback of a waveform sequence, and as a search location for selecting waveforms using SCPI.

<b>Key Path</b>	Source, Modulation Setup, ARB, Select Waveform, Segments on Hard Disk
<b>Remote Command</b>	:SOURce:RADio:ARB:DEFault:DIRectory <string> :SOURce:RADio:ARB: DEFault:DIRectory?
<b>Example</b>	:SOUR:RAD:ARB:DEF:DIR "D:\ArbFiles"

	:SOUR:RAD:ARB:DEF:DIR?
State Saved	Persistent, survives a power cycle and a preset but not saved in the instrument state
Initial S/W Revision	A.05.00

### Segments in ARB Memory

Allows you access to the sub-menus for managing the files within ARB memory.

Key Path	Source, Modulation Setup, ARB, Select Waveform
Initial S/W Revision	A.05.00

### Delete Segment From ARB Mem

Allows you to remove a segment from ARB playback memory.

Key Path	Source, Modulation Setup, ARB, Select Waveform, Segments in ARB Memory
<b>Remote Command</b>	:SOURce:RADio:ARB:DELeTe <string>
<b>Example</b>	:SOUR:RAD:ARB:DEL "testwaveform.bin"
Notes	<p>&lt;string&gt; - specifies the waveform to be deleted from the ARB playback memory.</p> <p>When in Sequence Analyzer mode and Include Source is Yes, an attempt to delete a file from ARB memory is rejected with an error.</p> <p>When Include Source is No and you specify a file that does not exist within ARB memory, an error is generated.</p> <p>It is possible to delete files from within the ARB memory when the ARB is ON. However, if you attempt to delete the file that is currently playing an error is generated.</p> <p>It is possible to delete a file from within the ARB memory when the sequencer state is ON and the file is not being used by the List Sequencer. If you attempt to delete a file which is being used by the list sequencer, an error is generated.</p> <p>When sequencer state is On, even if ARB state is On, the selected waveform will not be played. In this case, if the selected waveform is not used in List Sequence, it can be deleted and the ARB state is turned Off.</p> <p>If the ARB is ON and you load a file to ARB memory or delete a file from ARB memory, the playing waveform segment may not keep phase continuity during the ARB memory operation. The waveform will be replayed after the ARB operation is finished.</p>
Initial S/W Revision	A.05.00

### Delete All From ARB Memory

Allows you to remove all segments from ARB playback memory.

Key Path	Source, Modulation Setup, ARB, Select Waveform, Segments in ARB Memory
----------	------------------------------------------------------------------------

<b>Remote Command</b>	:SOURce:RADio:ARB:DELeTe:ALL
<b>Example</b>	:SOUR:RAD:ARB:DELeTe:ALL
<b>Notes</b>	<p>When in Sequence Analyzer mode and Include Source is Yes, an attempt to delete all files from ARB memory is rejected with an error.</p> <p>When Include Source is No and you attempt to delete all files from ARB memory when the ARB is currently playing a file, all files except the one playing are deleted and an error is generated.</p> <p>If you attempt to delete all files from ARB memory when there are waveform files used in "List Sequencer" on page 1449 and "Sequencer" on page 1449 state is ON, all files except the files currently being used in list sequencer are deleted, and an error is generated.</p> <p>If the ARB is ON and you load a file to ARB memory or delete a file from ARB memory, the playing waveform segment may not keep phase continuity during the ARB memory operation. The waveform will be replayed after the ARB operation is finished.</p>
<b>Initial S/W Revision</b>	A.05.00

### ARB Setup

Allows access to the ARB setup sub-menus.

<b>Key Path</b>	Source, Modulation Setup, ARB
<b>Initial S/W Revision</b>	A.05.00

### Sample Rate

Allows you to set the ARB waveform playback sample rate.

<b>Key Path</b>	Source, Modulation Setup, ARB, ARB Setup
<b>Remote Command</b>	:SOURce:RADio:ARB:SCLock:RATE <freq> :SOURce:RADio:ARB:SCLock:RATE?
<b>Example</b>	:SOUR:RAD:ARB:SCL:RATE 48.00 MHz
<b>Notes</b>	If there is a sample rate specified in the header of the waveform file, changing that sample rate is not recommended, as it may cause problems with burst timing.
<b>Dependencies</b>	When a new waveform is selected for playback the settings contained within the associated waveform header file are applied to the ARB. The sample rate is one of the values stored within the header file. If the newly selected waveform file has an associated header file, the sample rate is updated with the value from the header file. The sample rate will remain unchanged if the newly selected waveform does not have an associated header file.
<b>Preset</b>	125.00 MHz
<b>Min</b>	1.00 kHz
<b>Max</b>	125.00 MHz
<b>Initial S/W Revision</b>	A.05.00

### Run-Time Scaling

Allows you to adjust the run-time scaling value. The run-time scaling value is applied in real-time while the waveform is playing.

<b>Key Path</b>	Source, Modulation Setup, ARB, ARB Setup
<b>Remote Command</b>	:SOURce:RADio:ARB:RSCaling <real> :SOURce:RADio:ARB:RSCaling?
<b>Example</b>	:SOUR:RAD:ARB:RSC 100.00
<b>Notes</b>	This setting cannot be set in E6640A/M9420A. Grey out on menu and the value is fixed at 70.00%.
<b>Dependencies</b>	When a new waveform is selected for playback the settings contained within the associated waveform header file are applied to the ARB. The run-time scaling is one of the values stored within the header file. If the newly selected waveform file has an associated header file, the run-time scaling is updated with the value from the header file. The run-time scaling will remain unchanged if the newly selected waveform does not have an associated header file.
<b>Preset</b>	70.00 %
<b>Min</b>	1.00 %
<b>Max</b>	100.00 %
<b>Initial S/W Revision</b>	A.05.00

### Baseband Freq Offset

Allows you to adjust the value by which the baseband frequency is offset relative to the carrier.

<b>Key Path</b>	Source, Modulation Setup, ARB, ARB Setup
<b>Remote Command</b>	:SOURce:RADio:ARB:BASEband:FREQuency:OFFSet <freq> :SOURce:RADio:ARB:BASEband:FREQuency:OFFSet?
<b>Example</b>	:SOUR:RAD:ARB:BAS:FREQ:OFFS 0.00 Hz
<b>Dependencies</b>	When a new waveform is selected for playback the settings contained within the associated waveform header file are applied to the ARB. The baseband frequency offset is one of the values stored within the header file. If the newly selected waveform file has an associated header file, the baseband frequency offset is updated with the value from the header file. The baseband frequency offset will remain unchanged if the newly selected waveform does not have an associated header file.
<b>Preset</b>	0.00 Hz
<b>Min</b>	-50.00 MHz
<b>Max</b>	50.00 MHz
<b>Initial S/W Revision</b>	A.05.00

### Edit RMS

Allows you to edit or calculate current RMS of selected waveform.

Key Path	Source, Modulation Setup, ARB, ARB Setup
Initial S/W Revision	A.14.50

### Current RMS

Allows you to directly specify current RMS value used to playback currently selected waveform. Please note incorrect RMS value may cause inaccurate power output in E6640A/M9420A that is sensitive to RMS value.

This setting is also updated by RMS in waveform header or updated when invoking RMS calculation operation.

This setting can be saved to the header of currently selected waveform by invoking ["Save Setup To Header" on page 1445](#) "Save Setup To Header".

Key Path	Source, Modulation Setup, ARB, ARB Setup, Edit RMS
Remote Command	:SOURce:RADio:ARB:RMS <float> :SOURce:RADio:ARB:RMS?
Example	:SOUR:RAD:ARB:HEAD:RMS 0.7 :SOUR:RAD:ARB:HEAD:RMS?
Notes	Valid range is 0 to 1.414, values outside the range will be clipped to the closest boundary. Note this value does not affect <a href="#">"List Sequencer" on page 1449</a> Source List Sequencer that always uses RMS value resides in each ARB header. If want this value to take effect in list sequencer, use <a href="#">"Save Setup To Header" on page 1445</a> "Save Setup to Header" to save current RMS value to header first, then play the ARB in source list sequencer.
Dependencies	When a new waveform is selected for playback, this setting is updated by the RMS value defined in associated waveform header file. If selected waveform has no associated header file or header file does not specify RMS value, then instrument will try to calculate out one automatically. Calculating RMS can also update this setting.
Preset	0
Range	0 ~ 1.414
Initial S/W Revision	A.14.50

### RMS Calculation Mode

Allows you to specify the mode to calculate the current RMS.

Key Path	Source, Modulation Setup, ARB, ARB Setup, Edit RMS
Remote Command	:SOURce:RADio:ARB:RMS:CALCulation:MODE AUTO   M1   M2   M3   M4 :SOURce:RADio:ARB:RMS:CALCulation:MODE?
Example	:SOUR:RAD:ARB:RMS:CALC:MODE AUTO
Notes	If no waveform is selected, or selected waveform is waveform sequence, the key will grey out.



Preset	AUTO
Range	AUTO   M1   M2   M3   M4
Initial S/W Revision	A.14.50

**Auto**

RMS will be calculated based on the whole sample range of current selected waveform.

Key Path	Source, Modulation Setup, ARB, ARB Setup, Edit RMS, Calculate RMS, RMS Calculation Mode
<b>Example</b>	:SOUR:RAD:ARB:RMS:CALC:MODE AUTO
Initial S/W Revision	A.14.50

**Marker 1**

Selects marker 1 to designate sample range used for RMS calculation.

Key Path	Source, Modulation Setup, ARB, ARB Setup, Edit RMS, Calculate RMS, RMS Calculation Mode , Marker
<b>Example</b>	:SOUR:RAD:ARB:RMS:CALC:MODE M1
Initial S/W Revision	A.14.50

**Marker 2**

Selects marker 2 to designate sample range used for RMS calculation.

Key Path	Source, Modulation Setup, ARB, ARB Setup, Edit RMS, Calculate RMS, RMS Calculation Mode , Marker
<b>Example</b>	:SOUR:RAD:ARB:RMS:CALC:MODE M2
Initial S/W Revision	A.14.50

**Marker 3**

Selects marker 3 to designate sample range used for RMS calculation.

Key Path	Source, Modulation Setup, ARB, ARB Setup, Edit RMS, Calculate RMS, RMS Calculation Mode , Marker
<b>Example</b>	:SOUR:RAD:ARB:RMS:CALC:MODE M3
Initial S/W Revision	A.14.50

#### Marker 4

Selects marker 4 to designate sample range used for RMS calculation.

Key Path	Source, Modulation Setup, ARB, ARB Setup, Edit RMS, Calculate RMS, RMS Calculation Mode , Marker
<b>Example</b>	:SOUR:RAD:ARB:RMS:CALC:MODE M4
Initial S/W Revision	A.14.50

#### Calculate RMS

Allows you to calculate current RMS based on mode selected. This will update "[Current RMS](#)" on page 1418 Current RMS setting.

Key Path	Source, Modulation Setup, ARB, ARB Setup, Edit RMS, Calculate RMS
<b>Remote Command</b>	:SOURce:RADio:ARB:RMS:CALCulate
<b>Example</b>	:SOUR:RAD:ARB:RMS:CALC
Notes	<p>If no waveform is selected, invoking this operation will get error “-221 Setting conflict; No waveform is selected for RMS operation”.</p> <p>If no waveform is selected, or selected waveform is waveform sequence, the key will grey out.</p> <p>If selected waveform does not contain marker data, but "<a href="#">RMS Calculation Mode</a>" on page 1418 “RMS Calculation Mode” is set to marker, under this circumstance, invoking calculation operation will get error “-221 Setting conflict; There is no marker for currently selected waveform, auto RMS calculation mode is used instead”, and "<a href="#">RMS Calculation Mode</a>" on page 1418 “RMS Calculation Mode” will be coupled to “Auto” mode automatically.</p> <p>RMS calculation does not suit for waveform sequence. If selected waveform is waveform sequence file, invoking this operation will get error “-221 Setting conflict; RMS calculation does not apply to waveform sequence”. But users can still edit current RMS as play parameter, and can save current RMS to waveform sequence header for later use.</p>
Initial S/W Revision	A.14.50

#### Use Header RMS

Allows you to quickly set RMS in ARB header to "[Current RMS](#)" on page 1418 Current RMS setting.

Key Path	Source, Modulation Setup, ARB, ARB Setup, Edit RMS,
Notes	<p>No remote command, front panel only.</p> <p>If no waveform is selected, the key will grey out.</p> <p>If no waveform is selected, invoking this operation will get error “-221 Setting conflict; No waveform is selected for RMS operation”.</p>
Initial S/W Revision	A.14.50

## Trigger Type

Allows access to the trigger type sub-menus. The setting for trigger type determines the behavior of the waveform when it plays.

Key Path	Source, Modulation Setup, ARB
Remote Command	:SOURce:RADio:ARB:TRIGger:TYPE CONTInuous   SINGle   SADVance :SOURce:RADio:ARB:TRIGger:TYPE?
Example	:SOUR:RAD:ARB:TRIG:TYPE CONT :SOUR:RAD:ARB:TRIG:TYPE?
Notes	Gated trigger type will be implemented at a later release
Preset	CONTInuous
Range	Continuous   Single   Seg Adv
Initial S/W Revision	A.05.00

### Continuous

Sets the active trigger type to Continuous. If Continuous is already selected as the active trigger type, pressing this key allows access to the continuous trigger type setup menu. In Continuous trigger mode, the waveform repeats continuously.

Key Path	Source, Modulation Setup, ARB, Trigger Type
Remote Command	:SOURce:RADio:ARB:TRIGger:TYPE:CONTInuous[:TYPE] FREE   TRIGger   RESet :SOURce:RADio:ARB:TRIGger:TYPE:CONTInuous[:TYPE]?
Example	:SOUR:RAD:ARB:TRIG:TYPE:CONT FREE
Preset	FREE
Range	Free Run   Trigger + Run   Reset + Run
Initial S/W Revision	A.05.00

### Free Run

Selects Free Run as the trigger response for the continuous trigger type. Free Run sets the waveform generator to play a waveform sequence or segment continuously, without waiting for a trigger. In this mode, the waveform generator does not respond to triggers.

Key Path	Source, Modulation Setup, ARB, Trigger Type, Continuous
Example	:SOUR:RAD:ARB:TRIG:TYPE:CONT FREE
Initial S/W Revision	A.05.00

### Trigger + Run

Sets Trigger and Run as the trigger response for the continuous trigger type. Trigger and Run sets the waveform generator to play a waveform sequence or segment continuously when the first trigger is received, and to ignore any subsequent triggers.

<b>Key Path</b>	Source, Modulation Setup, ARB, Trigger Type, Continuous
<b>Example</b>	:SOUR:RAD:ARB:TRIG:TYPE:CONT TRIG
<b>Initial S/W Revision</b>	A.05.00

### Reset + Run

Sets Reset and Run as the trigger response for the continuous trigger type. Reset and Run sets the waveform generator to play a waveform sequence or segment continuously when the first trigger is received. Subsequent triggers reset the waveform sequence or segment to the start, and then play it continuously.

<b>Key Path</b>	Source, Modulation Setup, ARB, Trigger Type, Continuous
<b>Example</b>	:SOUR:RAD:ARB:TRIG:TYPE:CONT RES
<b>Initial S/W Revision</b>	A.05.00

### Single

Sets the active trigger type to Single. If Single is already selected as the active trigger type, pressing this key allows access to the single trigger type setup menu. In Single trigger mode, the waveform plays once.

<b>Key Path</b>	Source, Modulation Setup, ARB, Trigger Type
<b>Remote Command</b>	:SOURce:RADio:ARB:RETRigger ON OFF IMMediate :SOURce:RADio:ARB:RETRigger?
<b>Example</b>	:SOUR:RAD:ARB:RETR OFF
<b>Notes</b>	ON: Buffered Trigger OFF: No Retrigger Immediate: Restart on Trigger This is defined as an enumerated SCPI command, with ON OFF being considered as enumerated types rather than Boolean. This means the query will return OFF instead of 0, and ON instead of 1.
<b>Preset</b>	ON
<b>Range</b>	No Retrigger   Buffered Trigger   Restart on Trigger
<b>Initial S/W Revision</b>	A.05.00

### No Retrigger

Selects No Retrigger as the trigger response for single trigger type. No Retrigger sets the waveform generator to play a waveform sequence or segment once when a trigger is received. Any triggers then

received during playback are ignored.

Key Path	Source, Modulation Setup, ARB, Trigger Type, Single
<b>Example</b>	:SOUR:RAD:ARB:RETR OFF
Initial S/W Revision	A.05.00

### Buffered Trigger

Selects Buffered Trigger as the trigger response for single trigger type. Buffered Trigger sets the waveform generator to play a waveform sequence or segment once when a trigger is received. If a trigger is received during playback, the waveform generator plays the sequence or segment to the end, then plays the sequence or segment once more.

Key Path	Source, Modulation Setup, ARB, Trigger Type, Single
<b>Example</b>	:SOUR:RAD:ARB:RETR ON
Initial S/W Revision	A.05.00

### Restart on Trigger

Selects Restart on Trigger as the trigger response for single trigger type. Restart on Trigger sets the waveform generator to play a waveform sequence or segment once when a trigger is received. If a trigger is received during playback, the waveform generator resets and plays the sequence or segment from the start.

Key Path	Source, Modulation Setup, ARB, Trigger Type, Single
<b>Example</b>	:SOUR:RAD:ARB:RETR IMM
Initial S/W Revision	A.05.00

### Segment Advance

Sets the active trigger type to Segment Advance. If Segment Advance is already selected as the active trigger type, pressing this key allows access to the segment advance trigger type setup menu.

Segment Advance triggering allows you to control the playback of waveform segments within a waveform sequence. When a trigger is received the ARB advances to the next waveform segment within the waveform sequence. This type of triggering ignores the repetition count for the waveform segment within the waveform sequence. For example, if a waveform segment has a repetition count of 10 and you select single segment advance triggering mode, the waveform segment will only play once.

Segment Advance triggering can also be used for waveform segments only. In this situation the same waveform segment is played again when a trigger is received.

Key Path	Source, Modulation Setup, ARB, Trigger Type
<b>Remote Command</b>	:SOURce:RADio:ARB:TRIGger:TYPE:SADvance[:TYPE] SINGLE   CONTinuous

	:SOURce:RADio:ARB:TRIGger:TYPE:SADVance[:TYPE]?
<b>Example</b>	:SOUR:RAD:ARB:TRIG:TYPE:SADV SING
Preset	CONTInuous
Range	Single   Continuous
Initial S/W Revision	A.05.00

### Single

Selects Single as the trigger response for Segment Advance trigger type. With single selected, once a trigger is received a segment is played once. If a trigger is received during playback of a segment, the segment plays to completion and the next segment is played once.

Key Path	Source, Modulation Setup, ARB, Trigger Type, Segment Advance
<b>Example</b>	:SOUR:RAD:ARB:TRIG:TYPE:SADV SING
Initial S/W Revision	A.05.00

### Continuous

Selects Continuous as the trigger response for Segment Advance trigger type. With continuous selected, once a trigger is received a segment is played continuously. When subsequent triggers are received, the currently playing segment plays to completion and then the next segment is played continuously.

Key Path	Source, Modulation Setup, ARB, Trigger Type, Segment Advance
<b>Example</b>	:SOUR:RAD:ARB:TRIG:TYPE:SADV CONT
Initial S/W Revision	A.05.00

### ARB

Allows you access to the ARB sub-menus.

Key Path	Source, Modulation Setup
Initial S/W Revision	A.05.00

### Trigger Source

The trigger source setting determines how the source receives the trigger that starts the waveform playing. Therefore, this key is grayed out if the trigger type is free run, since free run triggers immediately with no trigger source required.

Key Path	Source, Modulation Setup, ARB
<b>Remote Command</b>	:SOURce:RADio:ARB:TRIGger[:SOURce] KEY BUS EXTErnal2

	:SOURce:RADio:ARB:TRIGger[:SOURce]?
<b>Example</b>	:SOUR:RAD:ARB:TRIGger KEY
Dependencies	This key is grayed out if the current trigger type is Continuous, Free Run.
Preset	EXTernal2
Range	Trigger Key   Bus   External 2
Initial S/W Revision	A.05.00

### Trigger Key

Sets the current trigger source to the front panel Trigger key. When Trigger Key is selected, the waveform is triggered when you press the front panel Trigger key.

Key Path	Source, Modulation Setup, ARB, Trigger Source
<b>Example</b>	:SOUR:RAD:ARB:TRIGger KEY
Initial S/W Revision	A.05.00

### Bus

Sets the current trigger source to Bus. Selecting Bus trigger source enables triggering over GPIB, LAN, or USB using the :SOURce:RADio:ARB:TRIGger:INITiate command.

Key Path	Source, Modulation Setup, ARB, Trigger Source
<b>Example</b>	:SOUR:RAD:ARB:TRIGger BUS
Initial S/W Revision	A.05.00

### External 2

Sets the current trigger source to External 2. Selecting External 2 enables triggering a waveform by an externally applied signal.

Key Path	Source, Modulation Setup, ARB, Trigger Source
<b>Example</b>	:SOUR:RAD:ARB:TRIGger EXT2
Notes	Note: When on E6640A, trigger 2 is a bi-directional trigger port. So when trigger 2 has been configured as OUTPUT type, choosing External 2 as the input trigger for the current step will generate error.
Initial S/W Revision	A.05.00

### External Trigger Delay

This key allows you to toggle the state and value of external trigger delay. The value you enter sets a delay time between when an external trigger is received and when it is applied to the waveform. This is key is

active only if you select external trigger as trigger source.

<b>Key Path</b>	Source, Modulation Setup, ARB, Trigger Source
<b>Remote Command</b>	:SOURce:RADio:ARB:TRIGger[:SOURce]:EXTernal:DELay <time> :SOURce:RADio:ARB:TRIGger[:SOURce]:EXTernal:DELay? SOURce:RADio:ARB:TRIGger[:SOURce]:EXTernal:DELay:STATe OFF   ON   0   1 :SOURce:RADio:ARB:TRIGger[:SOURce]:EXTernal:DELay:STATe?
<b>Example</b>	:SOUR:RAD:ARB:TRIG:EXT:DEL 100ns :SOUR:RAD:ARB:TRIG:EXT:DEL? :SOUR:RAD:ARB:TRIG:EXT:DEL:STAT ON :SOUR:RAD:ARB:TRIG:EXT:DEL:STAT?
<b>Notes</b>	External trigger delay time set by users will be rounded to the nearest integer multiple of the resolution.
<b>Dependencies</b>	This setting is unavailable and is grayed out when the Trigger Source is not set to external trigger.
<b>Preset</b>	1 ms OFF
<b>Min</b>	0 s
<b>Max</b>	8.589934588 s (Note: This value comes from $4\text{ns} * (2^{31} - 1) = 8589934588\text{ ns}$ )
<b>Initial S/W Revision</b>	A.14.50

### Trigger Initiate

Used to initiate an immediate trigger event if the trigger source is set to Trigger Key.

<b>Key Path</b>	Source, Modulation Setup, ARB
<b>Notes</b>	No remote command, SCPI front panel only.
<b>Initial S/W Revision</b>	A.05.00

### Waveform Sequences

Allows access to the waveform sequence sub-menus. Pressing this key changes the central view area to display the Waveform Sequence List view.

<b>Key Path</b>	Source, Modulation Setup, ARB
<b>Notes</b>	No remote command, SCPI front panel only.
<b>Initial S/W Revision</b>	A.05.00



### Build New Sequence

Allows access to the sub-menus for creating a new waveform sequence. Pressing this key changes the central view area to display the Waveform Sequence Creation and Editing view.

Key Path	Source, Modulation Setup, ARB, Waveform Sequences
Notes	No remote command, SCPI front panel only.
Initial S/W Revision	A.05.00

### Current Segment

Specifies the selected sequence segment that will be affected by the menu functions.

Key Path	Source, Modulation Setup , ARB, Waveform Sequences, Build New Sequence
Notes	No remote command, SCPI front panel only. This key is grayed out and unavailable if the sequence is currently empty.
Initial S/W Revision	A.05.00

### Insert New Waveform

Allows you access to the sub-menu for inserting a new waveform segment or sequence. Pressing this key also changes the central display to show the Waveform File Selection View.

Key Path	Source, Modulation Setup, ARB, Waveform Sequences, Build New Sequence
Notes	No remote command, SCPI front panel only. Waveform segment name string length upper limit is 128 chars. Please do NOT insert waveform which name string exceeds 128 chars.
Initial S/W Revision	A.05.00

### Insert Waveform

Inserts the currently highlighted waveform to the end of the waveform sequence. Pressing this key also returns you to the menus for creating or editing a sequence, and returns the central view to the sequence creation view.

Key Path	Source, Modulation Setup, ARB, Waveform Sequences, Build New Sequence, Insert New Waveform
Notes	No remote command, SCPI front panel only. Waveform segment name string length upper limit is 128 chars. Please do NOT insert waveform which name string exceeds 128 chars.
Initial S/W Revision	A.05.00

### Segments on Hard Disk

Allows you access to the sub-menus for loading waveform segments from the hard disk into ARB memory. The default directory is: D: varb.

Pressing this key changes the current view to the Waveform Management View.

Key Path	Source, Modulation Setup, ARB, Select Waveform
Initial S/W Revision	A.05.00

### Load Segment To ARB Memory

Allows you to load the selected file into ARB memory. On the front panel you select the file for loading to the ARB memory by highlighting the desired file in the list. Using the SCPI command, you specify the file name on the HDD.

“NVWFM” (none-volatile storage) MSUS (Mass Storage Unit Specifier) is supported in the memory subsystem because the ARB memory cannot be accessed directly. Therefore, files must be downloaded to the instrument hard disk and then loaded into the ARB memory. “NVWFM” MSUS will be mapped to the default directory D: VARB. The SCPI command supports using either “NVWFM” MSUS or specifying a full path. For more information, see Memory Subsystem (Remote Command Only).

If a file of the same name already exists within ARB memory, it is overwritten. If you wish to load two segments of the same name, you must rename one of the segments before loading it into ARB memory. To rename a segment, you can either use Windows File Explorer, or the :MMEMory:COPIY command.

NOTE: When a waveform file is loaded to ARB memory, burst timing adjustments are made automatically, based on whether or not a Multiport Adapter is connected to the test set and powered on. If the connection/power status of the Multiport Adapter is changed after a waveform file has been loaded, it needs to be loaded again.

Key Path	Source, Modulation Setup, ARB, Select Waveform, Segments on Hard Disk
Remote Command	:SOURce:RADio:ARB:LOAD <string>
Example	:SOUR:RAD:ARB:LOAD "D: VARB\testwaveform.bin" or :SOUR:RAD:ARB:LOAD "NVWFM:testwaveform.bin"
Notes	<p>Because loading the file involves a delay of unpredictable length, this command should be followed by the query *OPC?, which holds off subsequent commands until the loading operating is complete.</p> <p>&lt;string&gt; – specifies the path name of the file to load from the HDD into ARB memory. It could be a &lt;full path + filename&gt;, or &lt;"NVWFM" MSUS + colon + filename&gt;.</p> <p>When in Sequence Analyzer mode, and Include Source is Yes, an attempt to load a file to ARB memory will be rejected with an error.</p> <p>When Include Source is No and if there is insufficient free ARB memory to load the selected waveform, an error is generated. .</p> <p>If you specify a file over SCPI, but the file is not at the specified location, an error is generated.</p> <p>If you try to load a waveform file but the file contains less than 500 IQ samples, an error is generated.</p> <p>If you try to load a Signal Studio waveform "*.wfm" which contains invalid waveform header, an error is generated.</p>

---

If the ARB is ON when you load a file to ARB memory or delete a file from ARB memory, the playing waveform segment may not keep phase continuity during the ARB memory operation. The waveform will be replayed after the ARB operation is finished.

ARB can be loaded into ARB memory even if required licenses do not present on the instrument. In this case, a GUI only warning message -800, "Operation complete; Loaded <filename> successfully, but no license <required licenses> installed". User can install required licenses according to <required licenses> string to license it, or multi-pack license it.

---

Initial S/W Revision	A.05.00
----------------------	---------

---

### Load All To ARB Memory

Allows you to load all the segment files within the currently selected directory into ARB memory. If a file of the same name already exists within ARB memory, it is overwritten. If you wish to load two segments of the same name, you must rename one of the segments before loading it into ARB memory. To rename a segment, you can either use Windows File Explorer, or the :MEMORY:COPY command.

NOTE: When a waveform file is loaded to ARB memory, burst timing adjustments are made automatically, based on whether or not a Multiport Adapter is connected to the test set and powered on. If the connection/power status of the Multiport Adapter is changed after a waveform file has been loaded, it needs to be loaded again.

---

<b>Key Path</b>	Source, Modulation Setup, ARB, Select Waveform, Segments on Hard Disk
<b>Remote Command</b>	:SOURce:RADio:ARB:LOAD:ALL <string>
<b>Example</b>	:SOUR:RAD:ARB:LOAD:ALL "D: varb"
<b>Notes</b>	<p>&lt;string&gt; - specifies the directory on the HDD to load the files into ARB memory from.</p> <p>When in Sequence Analyzer mode, and Include Source is Yes, an attempt to load all files from a directory to ARB memory is rejected with an error.</p> <p>When Include Source is No and there is insufficient free ARB memory to load all the waveforms, when the ARB memory is full, the copy ceases, and an error is generated.</p> <p>If you specify a directory over SCPI, but the directory does not exist, an error is generated.</p> <p>If the ARB is ON, a user then loads or deletes file to ARB memory, the playing waveform segment may not keep phase continuity during the ARB memory operation. The waveform will be replayed after the ARB operation is finished.</p>
Initial S/W Revision	A.05.00

---

### Change Directory...

Allows you to change the currently selected directory on the hard disk. Pressing this key opens a standard windows change directory dialog allowing you to select the new directory of interest.

The current directory is used for manually loading waveform segments into ARB memory for playback, and as a search location for waveform segments that are required to be loaded into ARB memory for playback of a waveform sequence or a list sequence.

Key Path	Source, Modulation Setup, ARB, Select Waveform, Segments on Hard Disk
Notes	No remote command, SCPI front panel only.
Initial S/W Revision	A.05.00

#### Default Directory...

Allows you to change the default directory. It is used as a search location for waveform segments that are required to be loaded into ARB memory for playback of a waveform sequence, and as a search location for selecting waveforms using SCPI.

Key Path	Source, Modulation Setup, ARB, Select Waveform, Segments on Hard Disk
<b>Remote Command</b>	:SOURce:RADio:ARB:DEFault:DIRectory <string> :SOURce:RADio:ARB: DEFault:DIRectory?
<b>Example</b>	:SOUR:RAD:ARB:DEF:DIR "D:\ArbFiles" :SOUR:RAD:ARB:DEF:DIR?
State Saved	Persistent, survives a power cycle and a preset but not saved in the instrument state
Initial S/W Revision	A.05.00

#### Segments in ARB Memory

Allows you access to the sub-menus for managing the files within ARB memory.

Key Path	Source, Modulation Setup, ARB, Select Waveform
Initial S/W Revision	A.05.00

#### Delete Segment From ARB Mem

Allows you to remove a segment from ARB playback memory.

Key Path	Source, Modulation Setup, ARB, Select Waveform, Segments in ARB Memory
<b>Remote Command</b>	:SOURce:RADio:ARB:DELete <string>
<b>Example</b>	:SOUR:RAD:ARB:DEL "testwaveform.bin"
Notes	<string> - specifies the waveform to be deleted from the ARB playback memory. When in Sequence Analyzer mode and Include Source is Yes, an attempt to delete a file from ARB memory is rejected with an error. When Include Source is No and you specify a file that does not exist within ARB memory, an error is generated. It is possible to delete files from within the ARB memory when the ARB is ON. However, if you attempt to delete the file that is currently playing an error is generated. It is possible to delete a file from within the ARB memory when the sequencer state is ON and the file is not being used by the List Sequencer. If you attempt to delete a file which is being used by the list

---

sequencer, an error is generated.

When sequencer state is On, even if ARB state is On, the selected waveform will not be played. In this case, if the selected waveform is not used in List Sequence, it can be deleted and the ARB state is turned Off.

If the ARB is ON and you load a file to ARB memory or delete a file from ARB memory, the playing waveform segment may not keep phase continuity during the ARB memory operation. The waveform will be replayed after the ARB operation is finished.

---

Initial S/W Revision      A.05.00

---

### Delete All From ARB Memory

Allows you to remove all segments from ARB playback memory.

Key Path	Source, Modulation Setup, ARB, Select Waveform, Segments in ARB Memory
Remote Command	:SOURce:RADio:ARB:DELeTe:ALL
Example	:SOUR:RAD:ARB:DELeTe:ALL
Notes	<p>When in Sequence Analyzer mode and Include Source is Yes, an attempt to delete all files from ARB memory is rejected with an error.</p> <p>When Include Source is No and you attempt to delete all files from ARB memory when the ARB is currently playing a file, all files except the one playing are deleted and an error is generated.</p> <p>If you attempt to delete all files from ARB memory when there are waveform files used in "<a href="#">List Sequencer</a>" on page 1449 and "<a href="#">Sequencer</a>" on page 1449 state is ON, all files except the files currently being used in list sequencer are deleted, and an error is generated.</p> <p>If the ARB is ON and you load a file to ARB memory or delete a file from ARB memory, the playing waveform segment may not keep phase continuity during the ARB memory operation. The waveform will be replayed after the ARB operation is finished.</p>
Initial S/W Revision	A.05.00

---

### Edit Selected Waveform

Allows access to the sub-menus for editing the details of the currently selected waveform segment.

Key Path	Source, Modulation Setup, ARB, Waveform Sequences, Build New Sequence
Notes	No remote command, front panel only.
Initial S/W Revision	A.05.00

---

### Repetitions

Allows you to specify the number of times the currently selected waveform is played within the sequence.

Key Path	Source, Modulation Setup, ARB, Waveform Sequences, Build New Sequence, Edit Selected Waveform
----------	-----------------------------------------------------------------------------------------------

---

Notes	No remote command, SCPI front panel only.
Preset	1
Min	1
Max	65535
Initial S/W Revision	A.05.00

### Marker 1

Allows you to enable or disable marker 1 for the currently selected waveform. For a waveform sequence, you can enable and disable markers on a per-segment basis, allowing you to output markers from some waveform segments within the sequence, but not for others.

Key Path	Source, Modulation Setup, ARB, Waveform Sequences, Build New Sequence, Edit Selected Waveform
Notes	No remote command, front panel only.
Preset	Enabled
Range	Enabled Disabled
Initial S/W Revision	A.05.00

### Marker 2

Allows you to enable or disable marker 2 for the currently selected waveform. For a waveform sequence, you can enable and disable markers on a per-segment basis, allowing you to output markers from some waveform segments within the sequence, but not for others.

Key Path	Source, Modulation Setup, ARB, Waveform Sequences, Build New Sequence, Edit Selected Waveform
Notes	No remote command, front panel only.
Preset	Enabled
Range	Enabled Disabled
Initial S/W Revision	A.05.00

### Marker 3

Allows you to enable or disable marker 3 for the currently selected waveform. For a waveform sequence, you can enable and disable markers on a per-segment basis, allowing you to output markers from some waveform segments within the sequence, but not for others.

Key Path	Source, Modulation Setup, ARB, Waveform Sequences, Build New Sequence, Edit Selected Waveform
----------	-----------------------------------------------------------------------------------------------

Notes	No remote command, front panel only.
Preset	Enabled
Range	Enabled Disabled
Initial S/W Revision	A.05.00

**Marker 4**

Allows you to enable or disable marker 4 for the currently selected waveform. For a waveform sequence, you can enable and disable markers on a per-segment basis, allowing you to output markers from some waveform segments within the sequence, but not for others.

Key Path	Source, Modulation Setup, ARB, Waveform Sequences, Build New Sequence, Edit Selected Waveform
Notes	No remote command, front panel only.
Preset	Enabled
Range	Enabled Disabled
Initial S/W Revision	A.05.00

**Delete Segment**

Allows you to delete the selected segment from the waveform sequence.

Key Path	Source, Modulation Setup, ARB, Waveform Sequences, Build New Sequence
Notes	No remote command, front panel only.
Initial S/W Revision	A.05.00

**Save Sequence...**

Pressing this key displays the “Save As” dialog. The sequence name is passed to the save as dialog to use as the filename for saving, and the directory the save as dialog will open into is the default waveform directory.

Key Path	Source, Modulation Setup, ARB, Waveform Sequences, Build New Sequence
Initial S/W Revision	A.05.00

**Edit Selected Sequence**

Allows access to the sub-menus for editing the sequence currently selected within the Waveform Sequence List view. Pressing this key changes the central view area to display the Waveform Sequence Creation and Editing view.

Key Path	Source, Modulation Setup, ARB, Waveform Sequences
Notes	No remote command, front panel only.
Initial S/W Revision	A.05.00

#### Current Directory...

Allows you to change the currently selected directory on the hard disk. Pressing this key opens a standard windows change directory dialog and allows you to select the new directory of interest.

Key Path	Source, Modulation Setup, ARB, Waveform Sequences
Notes	No remote command, front panel only.
Initial S/W Revision	A.05.00

#### Waveform Utilities

Allows you access to the waveform utilities sub-menus.

Key Path	Source, Modulation Setup, ARB
Initial S/W Revision	A.05.00

#### Multi-Pack Licenses

Allows you access to the Multi - Pack License sub-menus. Pressing this key also changes the central view area to display the Multi -Pack License Management view.

On modular instrument like E6630A or E6640A, multi-pack license operations are only allowed on the default module, i.e. "Left" module for E6630A or "TRX1" module for E6640A.

Key Path	Source, Modulation Setup, ARB, Waveform Utilities
Dependencies	This key is only available if there is at least one Multi-pack license installed on the instrument.
Initial S/W Revision	A.05.00

#### Add Waveform

Pressing this key accesses the Add Waveform sub-menu. It also changes the central display area to display the Multi-Pack License Waveform Add view.

Key Path	Source, Modulation Setup, ARB, Waveform Utilities, Multi-Pack Licenses
Dependencies	This key is only available if there is at least one slot available within at least one multi-pack license.
Initial S/W Revision	A.05.00



## Add Waveform

Allows you to add the currently selected waveform segment to a multi-pack license. The new waveform is added to the next available slot regardless of which slot was selected on the Multi-Pack License Management view.

<b>Key Path</b>	Source, Modulation Setup, ARB, Waveform Utilities, Multi-Pack Licenses, Add Waveform
<b>Remote Command</b>	:SYSTem:LKEY:WAVeform:ADD <string> or :SYSTem:LICense[:FPACK]:WAVeform:ADD <string>
<b>Example</b>	SYST:LKEY:WAV:ADD "mywaveform.wfm" or SYST:LIC:WAV:ADD "mywaveform.wfm"
<b>Notes</b>	The second SCPI :SYSTem:LICense[:FPACK]:WAVeform:ADD is provided to be consistent with the style of Keysight signal sources. You can use either one of them. Since adding a waveform segment to a Multi-Pack license causes the license slot to enter the trial period of only 48 hours, pressing this key causes a confirmation dialog to be displayed to ensure you do want to add the waveform segment to the Multi-Pack. If you attempt to license a waveform that is already licensed using another slot an error is generated. .
<b>Dependencies</b>	This key is only available if the currently selected file is a secure waveform requiring a license, and there is at least one slot available within at least one multi-pack license. If the waveform highlighted is a secure waveform, but is already licensed, this key will be unavailable.
<b>Initial S/W Revision</b>	A.05.00

## Segments on Hard Disk

Allows you access to the sub-menus for loading waveform segments from the hard disk into ARB memory. The default directory is: D: varb.

Pressing this key changes the current view to the Waveform Management View.

<b>Key Path</b>	Source, Modulation Setup, ARB, Select Waveform
<b>Initial S/W Revision</b>	A.05.00

## Load Segment To ARB Memory

Allows you to load the selected file into ARB memory. On the front panel you select the file for loading to the ARB memory by highlighting the desired file in the list. Using the SCPI command, you specify the file name on the HDD.

"NVWFM" (none-volatile storage) MSUS (Mass Storage Unit Specifier) is supported in the memory subsystem because the ARB memory cannot be accessed directly. Therefore, files must be downloaded to the instrument hard disk and then loaded into the ARB memory. "NVWFM" MSUS will be mapped to the

default directory D: VARB. The SCPI command supports using either “NVWFM” MSUS or specifying a full path. For more information, see Memory Subsystem (Remote Command Only).

If a file of the same name already exists within ARB memory, it is overwritten. If you wish to load two segments of the same name, you must rename one of the segments before loading it into ARB memory. To rename a segment, you can either use Windows File Explorer, or the :MMEMory:COPI command.

NOTE: When a waveform file is loaded to ARB memory, burst timing adjustments are made automatically, based on whether or not a Multiport Adapter is connected to the test set and powered on. If the connection/power status of the Multiport Adapter is changed after a waveform file has been loaded, it needs to be loaded again.

<b>Key Path</b>	Source, Modulation Setup, ARB, Select Waveform, Segments on Hard Disk
<b>Remote Command</b>	:SOURce:RADio:ARB:LOAD <string>
<b>Example</b>	:SOUR:RAD:ARB:LOAD "D: VARB\testwaveform.bin" or :SOUR:RAD:ARB:LOAD "NVWFM:testwaveform.bin"
<b>Notes</b>	<p>Because loading the file involves a delay of unpredictable length, this command should be followed by the query *OPC?, which holds off subsequent commands until the loading operating is complete.</p> <p>&lt;string&gt; – specifies the path name of the file to load from the HDD into ARB memory. It could be a &lt;full path + filename&gt;, or &lt;"NVWFM" MSUS + colon + filename&gt;.</p> <p>When in Sequence Analyzer mode, and Include Source is Yes, an attempt to load a file to ARB memory will be rejected with an error.</p> <p>When Include Source is No and if there is insufficient free ARB memory to load the selected waveform, an error is generated. .</p> <p>If you specify a file over SCPI, but the file is not at the specified location, an error is generated.</p> <p>If you try to load a waveform file but the file contains less than 500 IQ samples, an error is generated.</p> <p>If you try to load a Signal Studio waveform "*.wfm" which contains invalid waveform header, an error is generated.</p> <p>If the ARB is ON when you load a file to ARB memory or delete a file from ARB memory, the playing waveform segment may not keep phase continuity during the ARB memory operation. The waveform will be replayed after the ARB operation is finished.</p> <p>ARB can be loaded into ARB memory even required licenses do not present on the instrument. In this case, a GUI only warning message -800, "Operation complete; Loaded &lt;filename&gt; successfully, but no license &lt;required licenses&gt; installed". User can install required licenses according to &lt;required licenses&gt; string to license it, or multi-pack license it.</p>
<b>Initial S/W Revision</b>	A.05.00

### Load All To ARB Memory

Allows you to load all the segment files within the currently selected directory into ARB memory. If a file of the same name already exists within ARB memory, it is overwritten. If you wish to load two segments of the same name, you must rename one of the segments before loading it into ARB memory. To rename a segment, you can either use Windows File Explorer, or the :MEMory:COPI command.

NOTE: When a waveform file is loaded to ARB memory, burst timing adjustments are made automatically, based on whether or not a Multiport Adapter is connected to the test set and powered on. If the

connection/power status of the Multiport Adapter is changed after a waveform file has been loaded, it needs to be loaded again.

Key Path	Source, Modulation Setup, ARB, Select Waveform, Segments on Hard Disk
Remote Command	:SOURce:RADio:ARB:LOAD:ALL <string>
Example	:SOUR:RAD:ARB:LOAD:ALL "D: varb"
Notes	<p>&lt;string&gt; - specifies the directory on the HDD to load the files into ARB memory from.</p> <p>When in Sequence Analyzer mode, and Include Source is Yes, an attempt to load all files from a directory to ARB memory is rejected with an error.</p> <p>When Include Source is No and there is insufficient free ARB memory to load all the waveforms, when the ARB memory is full, the copy ceases, and an error is generated.</p> <p>If you specify a directory over SCPI, but the directory does not exist, an error is generated.</p> <p>If the ARB is ON, a user then loads or deletes file to ARB memory, the playing waveform segment may not keep phase continuity during the ARB memory operation. The waveform will be replayed after the ARB operation is finished.</p>
Initial S/W Revision	A.05.00

#### Change Directory...

Allows you to change the currently selected directory on the hard disk. Pressing this key opens a standard windows change directory dialog allowing you to select the new directory of interest.

The current directory is used for manually loading waveform segments into ARB memory for playback, and as a search location for waveform segments that are required to be loaded into ARB memory for playback of a waveform sequence or a list sequence.

Key Path	Source, Modulation Setup, ARB, Select Waveform, Segments on Hard Disk
Notes	No remote command, SCPI front panel only.
Initial S/W Revision	A.05.00

#### Default Directory...

Allows you to change the default directory. It is used as a search location for waveform segments that are required to be loaded into ARB memory for playback of a waveform sequence, and as a search location for selecting waveforms using SCPI.

Key Path	Source, Modulation Setup, ARB, Select Waveform, Segments on Hard Disk
Remote Command	:SOURce:RADio:ARB:DEFault:DIRectory <string> :SOURce:RADio:ARB: DEFault:DIRectory?
Example	:SOUR:RAD:ARB:DEF:DIR "D:\ArbFiles" :SOUR:RAD:ARB:DEF:DIR?
State Saved	Persistent, survives a power cycle and a preset but not saved in the instrument state
Initial S/W Revision	A.05.00

## Replace Waveform

Pressing this key accesses the Replace Waveform submenu. It also changes the central display area to display the Multi-Pack License Waveform Add view.

Key Path	Source, Modulation Setup, ARB, Waveform Utilities, Multi-Pack Licenses
Dependencies	This key is only available if the currently selected slot is in the trial state.
Initial S/W Revision	A.05.00

## Replace Waveform

Allows you to replace the waveform in the currently selected slot with the waveform currently selected in the Multi-Pack License Waveform Add view.

Key Path	Source, Modulation Setup, ARB, Waveform Utilities, Multi-Pack Licenses, Replace Waveform
Remote Command	:SYSTem:LKEY:WAVeform:REPLace <int>, <string> or :SYSTem:LICense[:FPACK]:WAVeform:REPLace <int>, <string>
Example	SYST:LKEY:WAV:REPL 1, "myotherwaveform.wfm" or :SYST:LIC:WAV:REPL 1, "myotherwaveform.wfm"
Notes	The second SCPI :SYSTem:LICense[:FPACK]:WAVeform:REPLace is provided to be consistent with the style of Keysight signal sources. You can use either one of them. If you attempt to license a waveform that is already licensed using another slot an error is generated. Waveform slot number <int> is positive. If you attempt to input a slot number less than or equals 0, an error is generated.
Initial S/W Revision	A.05.00

## Clear Waveform from Slot

Allows you to clear the waveform from the selected slot.

Key Path	Source, Modulation Setup, ARB, Waveform Utilities, Multi-Pack Licenses
Remote Command	:SYSTem:LKEY:WAVeform:CLEar <int> or :SYSTem:LICense[:FPACK]:WAVeform:CLEar <int>
Example	SYST:LKEY:WAV:CLE 1 or :SYST:LIC:WAV:CLE 1
Notes	The second SCPI :SYSTem:LICense[:FPACK]:WAVeform:CLEar is provided to be consistent with the style of Keysight signal sources. You can use either one of them. Waveform slot number <int> is positive. If you attempt to input a slot number less than or equals 0, an

---

error is generated.

Dependencies	This key is only available if the currently selected slot is in the trial state.
Initial S/W Revision	A.05.00

### Lock Waveform in Slot

If the selected slot is in the trial state or the lock required state, the waveform that occupies the slot is locked and permanently licensed.

Key Path	Source, Modulation Setup, ARB, Waveform Utilities, Multi-Pack Licenses
Remote Command	:SYSTem:LKEY:WAVEform:LOCK <int> or :SYSTem:LICense[:FPACK]:WAVEform:LOCK <int>
Example	SYST:LKEY:WAV:LOCK 1 or SYST:LIC:WAV:LOCK 1
Notes	The second SCPI :SYSTem:LICense[:FPACK]:WAVEform:LOCK is provided to be consistent with the style of Keysight signal sources. You can use either one of them. Waveform slot number <int> is positive. If you attempt to input a slot number less than or equals 0, an error is generated.
Dependencies	This key is only available if the currently selected slot is in the trial state or the lock required state.
Initial S/W Revision	A.05.00

### Marker Utilities

Allows access to the marker utilities sub-menus.

Key Path	Source, Modulation Setup, ARB
Initial S/W Revision	A.05.00

### Marker Polarity

Allows access to the marker polarity sub-menu, which allows you to specify the polarity for the four markers. For a positive polarity, the marker signal is high during the marker points. For a negative marker polarity, the marker signal is high during the period of no marker points.

Key Path	Source, Modulation Setup, ARB, Marker Utilities
Initial S/W Revision	A.05.00

### Mkr 1 Polarity

Allows you to set the polarity of marker 1.

<b>Key Path</b>	Source, Modulation Setup, ARB, Marker Utilities, Marker Polarity
<b>Remote Command</b>	:SOURce:RADio:ARB:MPOLarity:MARKer1 POSitive NEGative :SOURce:RADio:ARB:MPOLarity:MARKer1?
<b>Example</b>	:SOUR:RAD:ARB:MPOL:MARK1 NEG
<b>Dependencies</b>	When a new waveform is selected for playback the settings contained within the associated waveform header file are applied to the ARB. The marker polarity is one of the values stored within the header file. If the newly selected waveform file has an associated header file, the marker polarity is updated with the value from the header file. The marker polarity will remain unchanged if the newly selected waveform does not have an associated header file.
<b>Preset</b>	Pos
<b>Range</b>	Neg   Pos
<b>Initial S/W Revision</b>	A.05.00

### Mkr 2 Polarity

Allows you to set the polarity of marker 2.

<b>Key Path</b>	Source, Modulation Setup, ARB, Marker Utilities, Marker Polarity
<b>Remote Command</b>	:SOURce:RADio:ARB:MPOLarity:MARKer2 POSitive NEGative :SOURce:RADio:ARB:MPOLarity:MARKer2?
<b>Example</b>	:SOUR:RAD:ARB:MPOL:MARK2 NEG
<b>Dependencies</b>	When a new waveform is selected for playback the settings contained within the associated waveform header file are applied to the ARB. The marker polarity is one of the values stored within the header file. If the newly selected waveform file has an associated header file, the marker polarity is updated with the value from the header file. The marker polarity will remain unchanged if the newly selected waveform does not have an associated header file.
<b>Preset</b>	Pos
<b>Range</b>	Neg   Pos
<b>Initial S/W Revision</b>	A.05.00

### Mkr 3 Polarity

Allows you to set the polarity of marker 3.

<b>Key Path</b>	Source, Modulation Setup, ARB, Marker Utilities, Marker Polarity
<b>Remote Command</b>	:SOURce:RADio:ARB:MPOLarity:MARKer3 POSitive NEGative :SOURce:RADio:ARB:MPOLarity:MARKer3?
<b>Example</b>	:SOUR:RAD:ARB:MPOL:MARK3 NEG
<b>Dependencies</b>	When a new waveform is selected for playback the settings contained within the associated

waveform header file are applied to the ARB. The marker polarity is one of the values stored within the header file. If the newly selected waveform file has an associated header file, the marker polarity is updated with the value from the header file. The marker polarity will remain unchanged if the newly selected waveform does not have an associated header file.

Preset	Pos
Range	Neg   Pos
Initial S/W Revision	A.05.00

### Mkr 4 Polarity

Allows you to set the polarity of marker 4.

Key Path	Source, Modulation Setup, ARB, Marker Utilities, Marker Polarity
Remote Command	:SOURce:RADio:ARB:MPOLarity:MARKer4 POSitive NEGative :SOURce:RADio:ARB:MPOLarity:MARKer4?
Example	:SOUR:RAD:ARB:MPOL:MARK4 NEG
Dependencies	When a new waveform is selected for playback the settings contained within the associated waveform header file are applied to the ARB. The marker polarity is one of the values stored within the header file. If the newly selected waveform file has an associated header file, the marker polarity is updated with the value from the header file. The marker polarity will remain unchanged if the newly selected waveform does not have an associated header file.
Preset	Pos
Range	Neg   Pos
Initial S/W Revision	A.05.00

### Marker Routing

Allows access to the marker routing sub-menus, which allow you to specify where the marker events are routed. It should be noted that the markers can also be routed to Trigger 1 Out and Trigger 2 Out, however this must be set up using the menus accessed by pressing the “Trigger” hard key.

Key Path	Source, Modulation Setup, ARB, Marker Utilities
Initial S/W Revision	A.05.00

### Pulse/RF Blank

Allows you to select which marker is used for the pulse/RF blanking function. The pulse/RF blanking function blanks the RF when the marker signal goes low. The marker polarity determines when the marker signal is high. For a positive polarity, this is during the marker points. For a negative polarity, this is when there are no marker points.

Marker points should be set before using this function. Enabling this function without setting marker points may create a continuous low or high signal, dependant on the marker polarity. This causes either no RF output, or a continuous RF output.

<b>Key Path</b>	Source, Modulation Setup, ARB, Marker Utilities, Marker Routing
<b>Remote Command</b>	:SOURce:RADio:ARB:MDEStination:PULSe NONE   M1   M2   M3   M4 :SOURce:RADio:ARB:MDEStination:PULSe?
<b>Example</b>	:SOUR:RAD:ARB:MDES:PULS NONE
<b>Dependencies</b>	When a new waveform is selected for playback the settings contained within the associated waveform header file are applied to the ARB. The pulse/RF blanking setting is one of the values stored within the header file. If the newly selected waveform file has an associated header file, the pulse/RF blanking setting is updated with the value from the header file. The pulse/RF blanking setting will remain unchanged if the newly selected waveform does not have an associated header file.
<b>Range</b>	None   M1   M2   M3   M4
<b>Initial S/W Revision</b>	A.05.00

#### None

Sets no marker to be used for the pulse/RF blanking function, essentially turning the RF blanking function off.

<b>Key Path</b>	Source, Modulation Setup, ARB, Marker Utilities, Marker Routing, Pulse/RF Blank
<b>Example</b>	:SOUR:RAD:ARB:MDES:PULS NONE
<b>Initial S/W Revision</b>	A.05.00

#### Marker 1

Sets marker 1 to be used for the pulse/RF blanking function.

<b>Key Path</b>	Source, Modulation Setup, ARB, Marker Utilities, Marker Routing, Pulse/RF Blank
<b>Example</b>	:SOUR:RAD:ARB:MDES:PULS M1
<b>Initial S/W Revision</b>	A.05.00

#### Marker 2

Sets marker 2 to be used for the pulse/RF blanking function.

<b>Key Path</b>	Source, Modulation Setup, ARB, Marker Utilities, Marker Routing, Pulse/RF Blank
<b>Example</b>	:SOUR:RAD:ARB:MDES:PULS M2
<b>Initial S/W Revision</b>	A.05.00



### Marker 3

Sets marker 3 to be used for the pulse/RF blanking function.

Key Path	Source, Modulation Setup, ARB, Marker Utilities, Marker Routing, Pulse/RF Blank
<b>Example</b>	:SOUR:RAD:ARB:MDES:PULS M3
Initial S/W Revision	A.05.00

### Marker 4

Sets marker 4 to be used for the pulse/RF blanking function.

Key Path	Source, Modulation Setup, ARB, Marker Utilities, Marker Routing, Pulse/RF Blank
<b>Example</b>	:SOUR:RAD:ARB:MDES:PULS M4
Initial S/W Revision	A.05.00

### ALC Hold

Allows you to specify which marker is routed for use within the ALC hold function. The ALC hold marker function holds the ALC circuitry at the average value of the sample points set by the marker.

The ALC hold function operates during the low periods of the marker signal. The marker polarity determines when the marker signal is high. For positive polarity, this is during the marker points. For a negative polarity, this is when there are no marker points.

Key Path	Source, Modulation Setup, ARB, Marker Utilities, Marker Routing
<b>Remote Command</b>	:SOURce:RADio:ARB:MDEStination:ALCHold NONE M1 M2 M3 M4 :SOURce:RADio:ARB:MDEStination:ALCHold?
<b>Example</b>	:SOUR:RAD:ARB:MDES:ALCH NONE
Dependencies	When a new waveform is selected for playback the settings contained within the associated waveform header file are applied to the ARB. The ALC hold setting is one of the values stored within the header file. If the newly selected waveform file has an associated header file, the ALC hold setting is updated with the value from the header file. The ALC hold setting will remain unchanged if the newly selected waveform does not have an associated header file.
Range	None   M1   M2   M3   M4
Initial S/W Revision	A.05.00

### None

Sets no marker to be used for the ALC hold function, essentially turning the ALC hold function off.

Key Path	Source, Modulation Setup, ARB, Marker Utilities, Marker Routing, ALC Hold
<b>Example</b>	:SOUR:RAD:ARB:MDES:PULS NONE
Initial S/W Revision	A.05.00

### Marker 1

Sets marker 1 to be used for the ALC hold function.

Key Path	Source, Modulation Setup, ARB, Marker Utilities, Marker Routing, ALC Hold
<b>Example</b>	:SOUR:RAD:ARB:MDES:PULS M1
Initial S/W Revision	A.05.00

### Marker 2

Sets marker 2 to be used for the ALC hold function.

Key Path	Source, Modulation Setup, ARB, Marker Utilities, Marker Routing, ALC Hold
<b>Example</b>	:SOUR:RAD:ARB:MDES:PULS M2
Initial S/W Revision	A.05.00

### Marker 3

Sets marker 3 to be used for the ALC hold function.

Key Path	Source, Modulation Setup, ARB, Marker Utilities, Marker Routing, ALC Hold
<b>Example</b>	:SOUR:RAD:ARB:MDES:PULS M3
Initial S/W Revision	A.05.00

### Marker 4

Sets marker 4 to be used for the ALC hold function.

Key Path	Source, Modulation Setup, ARB, Marker Utilities, Marker Routing, ALC Hold
<b>Example</b>	:SOUR:RAD:ARB:MDES:PULS M4
Initial S/W Revision	A.05.00

### Header Utilities

Allows access to the header utilities sub-menu. Pressing this key also causes the central display area to change to display the File Header Information view.

Key Path	Source, Modulation Setup, ARB
Dependencies	This key is only available if there is currently a waveform selected for playback. If no waveform is selected, the key is grayed out.
Initial S/W Revision	A.05.00

### Clear Header

Allows you to clear the header information from the file header associated with the currently selected waveform.

<b>Key Path</b>	Source, Modulation Setup, ARB, Header Utilities
<b>Remote Command</b>	:SOURce:RADio:ARB:HEADer:CLEar
<b>Example</b>	:SOUR:RAD:ARB:HEAD:CLE
<b>Notes</b>	Attempting to clear the header details via SCPI when no waveform was selected for playback will generate an error.
<b>Initial S/W Revision</b>	A.05.00

### Save Setup To Header

Allows you to save new file header information details to the file.

<b>Key Path</b>	Source, Modulation Setup, ARB, Header Utilities
<b>Remote Command</b>	:SOURce:RADio:ARB:HEADer:SAVE
<b>Example</b>	:SOUR:RAD:ARB:HEAD:SAVE
<b>Notes</b>	Attempting to save the header details via SCPI when no waveform was selected for playback will generate an error.
<b>Initial S/W Revision</b>	A.05.00

### AM

Allows access to the menu for configuring the Amplitude Modulation.

<b>Key Path</b>	Source, Modulation Setup
<b>Initial S/W Revision</b>	A.05.00

### AM

Enables or disables the amplitude modulation.

Turning AM on when another modulation format is already on results in the previous modulation format being turned off and the generation of an error.

<b>Key Path</b>	Source, Modulation Setup, AM
<b>Remote Command</b>	:SOURce:AM:STATe :SOURce:AM:STATe?
<b>Example</b>	:SOUR:AM:STAT OFF

Preset	Off
Range	On   Off
Initial S/W Revision	A.05.00

### AM Depth

Allows you to set the amplitude modulation depth in percent.

Key Path	Source, Modulation Setup, AM
<b>Remote Command</b>	:SOURce:AM[:DEPTh] [:LINear] :SOURce:AM[:DEPTh] [:LINear]?
<b>Example</b>	:SOUR:AM 0.1
Preset	0.1 %
Min	0.1 %
Max	95.0 %
Initial S/W Revision	A.05.00

### AM Rate

Allows you to set the internal amplitude modulation rate.

Key Path	Source, Modulation Setup, AM
<b>Remote Command</b>	:SOURce:AM:INTernal:FREQuency :SOURce:AM:INTernal:FREQuency?
<b>Example</b>	:SOUR:AM:INT:FREQ 40.0 Hz
Preset	400.0 Hz
Min	10 Hz
Max	40 kHz
Initial S/W Revision	A.05.00

### FM

Allows access to the menu for configuring the frequency modulation.

Key Path	Source, Modulation Setup
Initial S/W Revision	A.05.00

## FM

Enables or disables the frequency modulation.

Turning FM on when another modulation format is already on results in the previous modulation format being turned off and the generation of an error.

Key Path	Source, Modulation Setup, FM
<b>Remote Command</b>	:SOURce:FM:STATe :SOURce:FM:STATe?
<b>Example</b>	:SOUR:FM:STAT OFF
Preset	Off
Range	On   Off
Initial S/W Revision	A.05.00

## FM Deviation

Allows you to set the frequency modulation deviation.

Key Path	Source, Modulation Setup, FM
<b>Remote Command</b>	:SOURce:FM[:DEVIation] :SOURce:FM[:DEVIation]?
<b>Example</b>	:SOUR:FM 1.00 kHz
Preset	1.00 Hz
Min	1.00 Hz
Max	100.00 kHz
Initial S/W Revision	A.05.00

## FM Rate

Allows you to set the internal frequency modulation rate.

Key Path	Source, Modulation Setup, FM
<b>Remote Command</b>	:SOURce:FM:INTernal:FREQuency :SOURce:FM:INTernal:FREQuency?
<b>Example</b>	:SOUR:FM:INT:FREQ 40.0 Hz
Preset	400.0 Hz
Min	10 Hz
Max	40 kHz
Initial S/W Revision	A.05.00

## PM

Allows access to the menu for configuring the phase modulation.

Key Path	Source, Modulation Setup
Initial S/W Revision	A.05.00

## PM

Enables or disables the phase modulation.

Turning PM on when another modulation format is already on results in the previous modulation format being turned off and the generation of an error.

Key Path	Source, Modulation Setup, PM
<b>Remote Command</b>	:SOURce:PM:STATe :SOURce:PM:STATe?
<b>Example</b>	:SOUR:PM:STAT OFF
Preset	Off
Range	On   Off
Initial S/W Revision	A.05.00

## PM Deviation

Allows you to set the phase modulation deviation.

Key Path	Source, Modulation Setup, PM
<b>Remote Command</b>	:SOURce:PM[:DEViation] :SOURce:PM[:DEViation]?
<b>Example</b>	:SOUR:PM 1.00 rad
Preset	0.1 rad
Min	0.1 rad
Max	20.0 rad
Initial S/W Revision	A.05.00

## PM Rate

Allows you to set the internal phase modulation rate.

Key Path	Source, Modulation Setup, PM
<b>Remote Command</b>	:SOURce:PM:INTernal:FREQuency :SOURce:PM:INTernal:FREQuency?

<b>Example</b>	:SOUR:PM:INT:FREQ 40.0 Hz
Preset	400.0 Hz
Min	10 Hz
Max	40 kHz
Initial S/W Revision	A.05.00

## List Sequencer

Allows you access to the sub-menus for configuring the list sequencer.

List sequences allows you to enter frequencies and amplitudes at unequal intervals in nonlinear ascending, descending or random order. Each step within the list can also include its own waveform file for playback, step duration, trigger event and trigger output.

The complexities involved in configuring the list sequencer do not lend itself to manual configuration; hence the manual configuration for this feature is limited. For easier configuration of the list sequencer, it is recommended that you use either SCPI or load a tab delimited file containing the setup parameters in a tabular form. The details of the SCPI for configuring the list sequencer can be found in Step Configuration (Remote Command Only).

Once the List Sequencer has been configured using the front panel, SCPI, or loading in a tab delimited file, the sequence must be initiated using the front panel Initiate Sequence key or the corresponding SCPI command.

<b>Key Path</b>	<b>Source</b>
Initial S/W Revision	A.05.00

## Sequencer

Allows you to set the state of the list sequencer. When the list sequencer is on, the source is outputting the sequence defined by the sequencer. When the list sequencer is off, the source outputs a single waveform segment or sequence (independent mode) at a single frequency and amplitude.

<b>Key Path</b>	<b>Source, List Sequencer</b>
<b>Remote Command</b>	:SOURce:LIST[:STATe] ON OFF 1 0 :SOURce:LIST[:STATe]?
<b>Example</b>	:SOUR:LIST OFF
<b>Notes</b>	When the sequencer is set to ON, the list sequencer controls the output of the source.
<b>Couplings</b>	When in Sequence Analyzer mode and the list sequencer state is Off, Include Source is forced to No, and the Include Source key is grayed out. When in Sequence Analyzer mode and the list sequencer state is On, Include Source is available to set. And, an ARB memory related operation, like load or delete will be rejected.

Preset	Off
Range	On   Off
Initial S/W Revision	A.05.00

## Initiate Sequence

Pressing this key arms the sequence for single execution. Once the sequence is armed the source begins the sequence as soon as the trigger is received. If the trigger is set to Free Run, the sequence starts immediately.

Key Path	Source, List Sequencer
<b>Remote Command</b>	:SOURce:LIST:TRIGger [:IMMediate]
<b>Example</b>	:SOUR:LIST:TRIG
Notes	<p>When in Sequence Analyzer mode and Include Source is Yes, the Initiate list sequencer operation is rejected, and the key is grayed out, since source list sequence request is sent to physics via Parallel batch by sequence analyzer.</p> <p>If the file needed by the sequencer is not already in ARB memory, the sequence cannot be initiated and an error will be generated.</p> <p>There is a blocking SCPI query which can be used to query if source list sequence being initiated successfully or not. (see Query List Sequence Initiation Armed Status (Remote Command Only) Query Source List Sequence Armed Status)</p>
Dependencies	Under the Sequence Analyzer Mode, if Meas Setup->Include Source is set to YES, Source->List Sequencer->Initiate Sequence is disabled.
Initial S/W Revision	A.05.00

## List Sequencer Setup

Allows you access to the list sequencer setup menus.

Key Path	Source, List Sequencer
----------	------------------------

### Number of Steps

Allows you to specify the number of steps within the list sequence.

Key Path	Source, List Sequencer, List Sequencer Setup
<b>Remote Command</b>	:SOURce:LIST:NUMBer:STEPs <integer> :SOURce:LIST:NUMBer:STEPs?
<b>Example</b>	:SOUR:LIST:NUMB:STEP 1
Notes	Increasing the number of steps creates additional steps at the end of the list, with all the settings



---

within the steps set to their default values.

Decreasing the number of steps removes steps from the end of the list. The settings within the removed steps are not reset. This means that increasing the number of steps again would allow you to retrieve these steps.

Dependencies	The Step Count parameter is increased or decreased when you insert or delete a point from within the GUI interface to the sequencer.
Preset	1
Min	1
Max	1000
Initial S/W Revision	A.05.00

### Current Step

Allows you to select the step number you wish to view or edit.

Key Path	Source, List Sequencer, List Sequencer Setup
Notes	No remote command, front panel only.
Preset	1
Min	1
Max	Step Count
Initial S/W Revision	A.05.00

### Insert Step Before

Allows you to insert a new step, containing default values, before the currently selected step. Inserting a step will automatically increase the Step Count parameter by 1. If sequence already reaches upper limit of 1000 steps, then insert more step will be rejected and popup error -221, "Setting Conflict; Cannot insert more steps, maximum number of steps reached"

Key Path	Source, List Sequencer, List Sequencer Setup
Notes	No remote command, front panel only. If the list already contains the maximum limit of 1000 steps, no operation will be made after pressing this key.
Initial S/W Revision	A.05.00

### Delete Step

Allows you to delete the current step. Deleting a step will automatically decrease the Step Count parameter by 1. If sequence only has one step left, delete step will be rejected and popup error -221, "Setting conflict; Cannot delete current step, minimum number of steps reached"

Key Path	Source, List Sequencer, List Sequencer Setup
Notes	No remote command, Front Panel key only. If the list already contains the minimum limit of 1 step, no operation will be made after pressing this key
Initial S/W Revision	A.05.00

### Clear List

Allows you to clear the list. Clearing the list sets the number of steps to the default value of 1 and sets the parameters for the only step to their default values.

Key Path	Source, List Sequencer, List Sequencer Setup
Initial S/W Revision	A.05.00

### Step Trigger

Allows access to the sub-menu for selecting the trigger input for the current step.

Key Path	Source, List Sequencer, List Sequencer Setup
Remote Command	:SOURCE:LIST:STEP[1] 2 3...1000:SETup:INPut:TRIGger IMMEDIATE   INTERNAL   EXTERNAL2   KEY   BUS   EXTERNAL4  :SOURCE:LIST:STEP[1] 2 3...1000:SETup:INPut:TRIGger?
Example	:SOUR:LIST:STEP2:SET:INP:TRIG BUS :SOUR:LIST:STEP2:SET:INP:TRIG?
Notes	SCPI is supported after A.09.40
Preset	Free Run
Range	Free Run   Internal   Manual (Trigger Key)   Bus   External 2   EXTERNAL4
Initial S/W Revision	A.05.00

### Free Run

Sets the trigger input for the current step to Free Run.

Key Path	Source, List Sequencer, List Sequencer Setup, Step Trigger
Example	:SOUR:LIST:STEP2:SET:INP:TRIG IMM
Notes	SCPI is supported after A.09.40
Initial S/W Revision	A.05.00

### Internal

Sets the trigger input for the current step to Internal.

Key Path	Source, List Sequencer, List Sequencer Setup, Step Trigger
<b>Example</b>	:SOUR:LIST:STEP2:SET:INP:TRIG INT
Notes	SCPI is supported after A.09.40
Initial S/W Revision	A.05.00

### Manual (Trigger Key)

Sets the trigger input for the current step to Manual (Trigger Key). Any step in the sequence set to Manual will cause the sequence execution to stop until the manual trigger key is pressed. Sending the Bus Trigger SCPI command will have no effect. At any point in the sequence where the list sequencer is paused waiting for a software trigger, a pop up dialog is displayed until the trigger event occurs.

Key Path	Source, List Sequencer, List Sequencer Setup, Step Trigger
<b>Example</b>	:SOUR:LIST:STEP2:SET:INP:TRIG KEY
Notes	SCPI is supported after A.09.40
Initial S/W Revision	A.05.00

### Bus

Sets the trigger input for the current step to Bus. Any step in the sequence set to Bus will cause the sequence execution to stop until the Bus Trigger SCPI command is sent. Pressing the manual trigger key has no effect. At any point in the sequence where the list sequencer is paused waiting for a software trigger, a pop up dialog is displayed until the trigger event occurs.

Key Path	Source, List Sequencer, List Sequencer Setup, Step Trigger
<b>Example</b>	:SOUR:LIST:STEP2:SET:INP:TRIG BUS
Notes	SCPI is supported after A.09.40
Initial S/W Revision	A.05.00

### External 2

Sets the trigger input for the current step to External 2.

Key Path	Source, List Sequencer, List Sequencer Setup, Step Trigger
<b>Example</b>	:SOUR:LIST:STEP2:SET:INP:TRIG EXT2
Notes	SCPI is supported after A.09.40
Notes	Note: When on E6640A, trigger 2 is a bi-directional trigger port. So when trigger 2 has been configured as OUTPUT type, choosing External 2 as the input trigger for the current step will generate error.
Initial S/W Revision	A.05.00

## Transition Time

Allows you to specify the transition time for the current step.

The transition time is the amount of time allowed for the source to settle at the current frequency or amplitude value.

Transition Time should not be taken as additional time before or inside the Step Duration. You can set a value for the settling time to allow the source output frequency or amplitude to become stable. Make sure that during this period of time, you do not use the source output signal.

The following table lists recommended values for appropriate settling times to allow for changes within the source.

Value Changed	Recommended Transition Time
Frequency	500 $\mu$ s
Amplitude	100 $\mu$ s to within 0.1 dB 20 $\mu$ s to within 1.0 dB

If the Transition Time value is shorter than the time necessary for the hardware to settle and a List Sequence is initiated, a **warning** is generated.

If the Transition Time value is longer than the Step Duration, an error is generated when initiating a source list sequence. For source list sequence, transition time is included in the step duration length. If the Transition Time value is longer than the Step Duration Time, the real step duration length is extended to equal the transition time and cause a timing shift.

Key Path	Source, List Sequencer, List Sequencer Setup
Remote Command	:SOURce:LIST:STEP[1] 2 3...1000:SETup:TRANSition:TIME <time> :SOURce:LIST:STEP[1] 2 3...1000:SETup:TRANSition:TIME?
Example	:SOUR:LIST:STEP2:SET:TRAN:TIME 1ms :SOUR:LIST:STEP2:SET:TRAN:TIME?
Notes	SCPI is supported after A.09.40
Preset	1.0 ms
Min	0.0 ms
Max	4.0 ks
Initial S/W Revision	A.05.00

## Radio Setup

Allows you access to the sub-menus for setting up the radio standard, band, and radio band link direction for the current step.

Key Path	Source, List Sequencer, List Sequencer Setup
Notes	No remote command, front panel only.

---

Initial S/W Revision	A.05.00
----------------------	---------

---

### Radio Standard

Allows access to the sub-menus for selecting the radio standard and the associated radio band for use in the current step.

---

Key Path	Source, List Sequencer, List Sequencer Setup, Radio Setup
Remote Command	:SOURCE:LIST:STEP[1] 2 3...1000:SETup:RADio:BAND NONE   PGSM   EGSM   RGSM   DCS1800   PCS1900   TGSM810   GSM450   GSM480   GSM700   GSM850   BANDI   BANDII   BANDIII   BANDIV   BANDV   BANDVI   BANDVII   BANDVIII   BANDIX   BANDX   BANDXI   BANDXII   BANDXIII   BANDXIV   BANDXIX   USCELL   USPCS   JAPAN   KOREAN   NMT   IMT2K   UPPER   SECOND   PAMR400   PAMR800   IMTEXT   PCS1DOT9G   AWS   US2DOT5G   PUBLIC   LOWER   NONE   BAND1   BAND2   BAND3   BAND4   BAND5   BAND6   BAND7   BAND8   BAND10   BAND11   BAND12   BAND13   BAND14   BAND17   BAND18   BAND19   BAND20   BAND21   BAND24   BAND25   BAND26   BAND27   BAND28   BAND29   BAND30   BAND31   BAND33   BAND34   BAND35   BAND36   BAND37   BAND38   BAND39   BAND40   BAND41   BAND42   BAND43   BAND44   BANDA   BANDB   BANDC   BANDD   BANDE   BANDF  :SOURCE:LIST:STEP[1] 2 3...1000:SETup: RADio:BAND?
Example	:SOUR:LIST:STEP2:SET:RAD:BAND PGSM :SOUR:LIST:STEP2:SET:RAD:BAND?
Notes	SCPI is supported after A.09.40
Initial S/W Revision	A.05.00

---

### None

Selects no radio standard for use on the current step.

---

Key Path	Source, List Sequencer, List Sequencer Setup, Radio Setup, Radio Standard
Example	:SOUR:LIST:STEP2:SET:RAD:BAND NONE
Notes	SCPI is supported after A.09.40
Initial S/W Revision	A.05.00

---

### GSM/EDGE

Pressing this key once selects GSM/EDGE as the radio standard and the current GSM/EDGE band as the active channel band. Pressing this key again allows access to the sub-menus for selecting a different GSM/EDGE band.

---

Key Path	Source, List Sequencer, List Sequencer Setup, Radio Setup, Radio Standard
Initial S/W Revision	A.05.00

---

### P-GSM

Selects P-GSM as the band for the current step.

Key Path	Source, List Sequencer, List Sequencer Setup, Radio Setup, Radio Standard, GSM/EDGE
Initial S/W Revision	A.05.00

### E-GSM

Selects E-GSM as the band for the current step.

Key Path	Source, List Sequencer, List Sequencer Setup, Radio Setup, Radio Standard, GSM/EDGE
Initial S/W Revision	A.05.00

### R-GSM

Selects R-GSM as the band for the current step.

Key Path	Source, List Sequencer, List Sequencer Setup, Radio Setup, Radio Standard, GSM/EDGE
Initial S/W Revision	A.05.00

### DCS 1800

Selects DCS 1800 as the band for the current step.

Key Path	Source, List Sequencer, List Sequencer Setup, Radio Setup, Radio Standard, GSM/EDGE
Initial S/W Revision	A.05.00

### PCS 1900

Selects PCS 1900 as the band for the current step.

Key Path	Source, List Sequencer, List Sequencer Setup, Radio Setup, Radio Standard, GSM/EDGE
Initial S/W Revision	A.05.00

### GSM 450

Selects GSM 450 as the band for the current step.

Key Path	Source, List Sequencer, List Sequencer Setup, Radio Setup, Radio Standard, GSM/EDGE
Initial S/W Revision	A.05.00

**GSM 480**

Selects GSM 480 as the band for the current step.

Key Path	Source, List Sequencer, List Sequencer Setup, Radio Setup, Radio Standard, GSM/EDGE
Initial S/W Revision	A.05.00

**GSM 850**

Selects GSM 850 as the band for the current step.

Key Path	Source, List Sequencer, List Sequencer Setup, Radio Setup, Radio Standard, GSM/EDGE
Initial S/W Revision	A.05.00

**GSM 700**

Selects GSM 700 as the band for the current step.

Key Path	Source, List Sequencer, List Sequencer Setup, Radio Setup, Radio Standard, GSM/EDGE
Initial S/W Revision	A.05.00

**T-GSM 810**

Selects T-GSM 810 as the band for the current step.

Key Path	Source, List Sequencer, List Sequencer Setup, Radio Setup, Radio Standard, GSM/EDGE
Initial S/W Revision	A.05.00

**WCDMA**

Pressing this key once selects WCDMA as the radio standard and the current WCDMA band as the active channel band. Pressing this key again allows access to the sub-menus for selecting a different WCDMA band.

Key Path	Source, List Sequencer, List Sequencer Setup, Radio Setup, Radio Standard
Initial S/W Revision	A.05.00

**Band I**

Selects Band I as the band for the current step.

---

Key Path	Source, List Sequencer, List Sequencer Setup, Radio Setup, Radio Standard, WCDMA
Initial S/W Revision	A.05.00

---

#### Band II

Selects Band II as the band for the current step.

---

Key Path	Source, List Sequencer, List Sequencer Setup, Radio Setup, Radio Standard, WCDMA
Initial S/W Revision	A.05.00

---

#### Band III

Selects Band III as the band for the current step.

---

Key Path	Source, List Sequencer, List Sequencer Setup, Radio Setup, Radio Standard, WCDMA
Initial S/W Revision	A.05.00

---

#### Band IV

Selects Band IV as the band for the current step.

---

Key Path	Source, List Sequencer, List Sequencer Setup, Radio Setup, Radio Standard, WCDMA
Initial S/W Revision	A.05.00

---

#### Band V

Selects Band V as the band for the current step.

---

Key Path	Source, List Sequencer, List Sequencer Setup, Radio Setup, Radio Standard, WCDMA
Initial S/W Revision	A.05.00

---

#### Band VI

Selects Band VI as the band for the current step.

---

Key Path	Source, List Sequencer, List Sequencer Setup, Radio Setup, Radio Standard, WCDMA
Initial S/W Revision	A.05.00

---

#### Band VII

Selects Band VII as the band for the current step.



---

Key Path	Source, List Sequencer, List Sequencer Setup, Radio Setup, Radio Standard, WCDMA
Initial S/W Revision	A.05.00

---

**Band VIII**

Selects Band VIII as the band for the current step.

---

Key Path	Source, List Sequencer, List Sequencer Setup, Radio Setup, Radio Standard, WCDMA
Initial S/W Revision	A.05.00

---

**Band IX**

Selects Band IX as the band for the current step.

---

Key Path	Source, List Sequencer, List Sequencer Setup, Radio Setup, Radio Standard, WCDMA
Initial S/W Revision	A.05.00

---

**Band X**

Selects Band X as the band for the current step.

---

Key Path	Source, List Sequencer, List Sequencer Setup, Radio Setup, Radio Standard, WCDMA
Initial S/W Revision	A.05.00

---

**Band XI**

Selects Band XI as the band for the current step.

---

Key Path	Source, List Sequencer, List Sequencer Setup, Radio Setup, Radio Standard, WCDMA
Initial S/W Revision	A.05.00

---

**Band XII**

Selects Band XII as the band for the current step.

---

Key Path	Source, List Sequencer, List Sequencer Setup, Radio Setup, Radio Standard, WCDMA
Initial S/W Revision	A.05.00

---

**Band XIII**

Selects Band XIII as the band for the current step.

---

Key Path	Source, List Sequencer, List Sequencer Setup, Radio Setup, Radio Standard, WCDMA
Initial S/W Revision	A.05.00

---

#### Band XIV

Selects Band XIV as the band for the current step.

---

Key Path	Source, List Sequencer, List Sequencer Setup, Radio Setup, Radio Standard, WCDMA
Initial S/W Revision	A.05.00

---

#### LTE

Pressing this key once selects LTE FDD as the radio standard and the current LTE FDD band as the active channel band. Pressing this key again allows access to the sub-menus for selecting a different LTE FDD band.

---

Key Path	Source, List Sequencer, List Sequencer Setup, Radio Setup, Radio Standard
Initial S/W Revision	A.09.50

---

#### BAND 1

Selects BAND 1 as the band for the current step.

---

Key Path	Source, List Sequencer, List Sequencer Setup, Radio Setup, Radio Standard, LTE
Initial S/W Revision	A.09.50

---

#### BAND 2

Selects BAND 2 as the band for the current step.

---

Key Path	Source, List Sequencer, List Sequencer Setup, Radio Setup, Radio Standard, LTE
Initial S/W Revision	A.09.50

---

#### BAND 3

Selects BAND 3 as the band for the current step.

---

Key Path	Source, List Sequencer, List Sequencer Setup, Radio Setup, Radio Standard, LTE
Initial S/W Revision	A.09.50

---

**BAND 4**

Selects BAND 4 as the band for the current step.

Key Path	Source, List Sequencer, List Sequencer Setup, Radio Setup, Radio Standard, LTE
Initial S/W Revision	A.09.50

**BAND 5**

Selects BAND 5 as the band for the current step.

Key Path	Source, List Sequencer, List Sequencer Setup, Radio Setup, Radio Standard, LTE
Initial S/W Revision	A.09.50

**BAND 6**

Selects BAND 6 as the band for the current step.

Key Path	Source, List Sequencer, List Sequencer Setup, Radio Setup, Radio Standard, LTE
Initial S/W Revision	A.09.50

**BAND 7**

Selects BAND 7 as the band for the current step.

Key Path	Source, List Sequencer, List Sequencer Setup, Radio Setup, Radio Standard, LTE
Initial S/W Revision	A.09.50

**BAND 8**

Selects BAND 8 as the band for the current step.

Key Path	Source, List Sequencer, List Sequencer Setup, Radio Setup, Radio Standard, LTE
Initial S/W Revision	A.09.50

**BAND 9**

Selects BAND 9 as the band for the current step.

Key Path	Source, List Sequencer, List Sequencer Setup, Radio Setup, Radio Standard, LTE
Initial S/W Revision	A.09.50

#### BAND 10

Selects BAND 10 as the band for the current step.

Key Path	Source, List Sequencer, List Sequencer Setup, Radio Setup, Radio Standard, LTE
Initial S/W Revision	A.09.50

#### BAND 11

Selects BAND 11 as the band for the current step.

Key Path	Source, List Sequencer, List Sequencer Setup, Radio Setup, Radio Standard, LTE
Initial S/W Revision	A.09.50

#### BAND 12

Selects BAND 12 as the band for the current step.

Key Path	Source, List Sequencer, List Sequencer Setup, Radio Setup, Radio Standard, LTE
Initial S/W Revision	A.09.50

#### BAND 13

Selects BAND 13 as the band for the current step.

Key Path	Source, List Sequencer, List Sequencer Setup, Radio Setup, Radio Standard, LTE
Initial S/W Revision	A.09.50

#### BAND 14

Selects BAND 14 as the band for the current step.

Key Path	Source, List Sequencer, List Sequencer Setup, Radio Setup, Radio Standard, LTE
Initial S/W Revision	A.09.50

#### BAND 17

Selects BAND 17 as the band for the current step.

Key Path	Source, List Sequencer, List Sequencer Setup, Radio Setup, Radio Standard, LTE
Initial S/W Revision	A.09.50

**BAND 18**

Selects BAND 18 as the band for the current step.

Key Path	Source, List Sequencer, List Sequencer Setup, Radio Setup, Radio Standard, LTE
Initial S/W Revision	A.09.50

**BAND 19**

Selects BAND 19 as the band for the current step.

Key Path	Source, List Sequencer, List Sequencer Setup, Radio Setup, Radio Standard, LTE
Initial S/W Revision	A.09.50

**BAND 20**

Selects BAND 20 as the band for the current step.

Key Path	Source, List Sequencer, List Sequencer Setup, Radio Setup, Radio Standard, LTE
Initial S/W Revision	A.09.50

**BAND 21**

Selects BAND 21 as the band for the current step.

Key Path	Source, List Sequencer, List Sequencer Setup, Radio Setup, Radio Standard, LTE
Initial S/W Revision	A.09.50

**BAND 24**

Selects BAND 24 as the band for the current step.

Key Path	Source, List Sequencer, List Sequencer Setup, Radio Setup, Radio Standard, LTE
Initial S/W Revision	A.09.50

**BAND 25**

Selects BAND 25 as the band for the current step.

Key Path	Source, List Sequencer, List Sequencer Setup, Radio Setup, Radio Standard, LTE
Initial S/W Revision	A.09.50

### BAND 26

Selects BAND 26 as the band for the current step.

Key Path	Source, List Sequencer, List Sequencer Setup, Radio Setup, Radio Standard, LTE
Initial S/W Revision	A.12.53

### BAND 27

Selects BAND 27 as the band for the current step.

Key Path	Source, List Sequencer, List Sequencer Setup, Radio Setup, Radio Standard, LTE
Initial S/W Revision	A.14.00

### BAND 28

Selects BAND 28 as the band for the current step.

Key Path	Source, List Sequencer, List Sequencer Setup, Radio Setup, Radio Standard, LTE
Initial S/W Revision	A.14.00

### BAND 31

Selects BAND 31 as the band for the current step.

Key Path	Source, List Sequencer, List Sequencer Setup, Radio Setup, Radio Standard, LTE
Initial S/W Revision	A.14.00

### LTE TDD

Sets LTE TDD as the radio standard for use and accesses the LTE TDD specific channel band sub-menus..

Key Path	Source, Frequency, Radio Setup, Radio Standard
Initial S/W Revision	A.11.50

### BAND 33

Selects BAND 33 as the band for the current step.

Key Path	Source, Frequency, Radio Setup, Radio Standard, LTE TDD
<b>Example</b>	:SOUR:FREQ:CHAN:BAND BAND33
Initial S/W Revision	A.11.50

**BAND 34**

Selects BAND 34 as the band for the current step.

Key Path	Source, Frequency, Radio Setup, Radio Standard, LTE TDD
<b>Example</b>	:SOUR:FREQ:CHAN:BAND BAND34
Initial S/W Revision	A.11.50

**BAND 35**

Selects BAND 35 as the band for the current step.

Key Path	Source, Frequency, Radio Setup, Radio Standard, LTE TDD
<b>Example</b>	:SOUR:FREQ:CHAN:BAND BAND35
Initial S/W Revision	A.11.50

**BAND 36**

Selects BAND 36 as the band for the current step.

Key Path	Source, Frequency, Radio Setup, Radio Standard, LTE TDD
<b>Example</b>	:SOUR:FREQ:CHAN:BAND BAND36
Initial S/W Revision	A.11.50

**BAND 37**

Selects BAND 37 as the band for the current step.

Key Path	Source, Frequency, Radio Setup, Radio Standard, LTE TDD
<b>Example</b>	:SOUR:FREQ:CHAN:BAND BAND37
Initial S/W Revision	A.11.50

**BAND 38**

Selects BAND 38 as the band for the current step.

Key Path	Source, Frequency, Radio Setup, Radio Standard, LTE TDD
<b>Example</b>	:SOUR:FREQ:CHAN:BAND BAND38
Initial S/W Revision	A.11.50

### BAND 39

Selects BAND 39 as the band for the current step.

Key Path	Source, Frequency, Radio Setup, Radio Standard, LTE TDD
<b>Example</b>	:SOUR:FREQ:CHAN:BAND BAND39
Initial S/W Revision	A.11.50

### BAND 40

Selects BAND 40 as the band for the current step.

Key Path	Source, Frequency, Radio Setup, Radio Standard, LTE TDD
<b>Example</b>	:SOUR:FREQ:CHAN:BAND BAND40
Initial S/W Revision	A.11.50

### BAND 41

Selects BAND 41 as the band for the current step.

Key Path	Source, Frequency, Radio Setup, Radio Standard, LTE TDD
<b>Example</b>	:SOUR:FREQ:CHAN:BAND BAND41
Initial S/W Revision	A.11.50

### BAND 42

Selects BAND 42 as the band for the current step.

Key Path	Source, Frequency, Radio Setup, Radio Standard, LTE TDD
<b>Example</b>	:SOUR:FREQ:CHAN:BAND BAND42
Initial S/W Revision	A.11.50

### BAND 43

Selects BAND 43 as the band for the current step.

Key Path	Source, Frequency, Radio Setup, Radio Standard, LTE TDD
<b>Example</b>	:SOUR:FREQ:CHAN:BAND BAND43
Initial S/W Revision	A.11.50



**BAND 44**

Selects BAND 44 as the band for the current step.

Key Path	Source, List Sequencer, List Sequencer Setup, Radio Setup, Radio Standard, LTE TDD
Initial S/W Revision	A.14.00

**TDSCDMA**

Sets TDSCDMA as the radio standard for use and accesses the TDSCDMA specific channel band sub-menus..

Key Path	Source, Frequency, Radio Setup, Radio Standard
Initial S/W Revision	A.11.50

**BAND A**

Selects BAND A as the band for the current step.

Key Path	Source, Frequency, Radio Setup, Radio Standard, TDSCDMA
<b>Example</b>	:SOUR:FREQ:CHAN:BAND BANDA
Initial S/W Revision	A.11.50

**BAND B**

Selects BAND B as the band for the current step.

Key Path	Source, Frequency, Radio Setup, Radio Standard, TDSCDMA
<b>Example</b>	:SOUR:FREQ:CHAN:BAND BANDB
Initial S/W Revision	A.11.50

**BAND C**

Selects BAND C as the band for the current step.

Key Path	Source, Frequency, Radio Setup, Radio Standard, TDSCDMA
<b>Example</b>	:SOUR:FREQ:CHAN:BAND BANDC
Initial S/W Revision	A.11.50

**BAND D**

Selects BAND D as the band for the current step.

Key Path	Source, Frequency, Radio Setup, Radio Standard, TDSCDMA
<b>Example</b>	:SOUR:FREQ:CHAN:BAND BANDD
Initial S/W Revision	A.11.50

#### BAND E

Selects BAND E as the band for the current step.

Key Path	Source, Frequency, Radio Setup, Radio Standard, TDSCDMA
<b>Example</b>	:SOUR:FREQ:CHAN:BAND BANDE
Initial S/W Revision	A.11.50

#### BAND F

Selects BAND F as the band for the current step.

Key Path	Source, Frequency, Radio Setup, Radio Standard, TDSCDMA
<b>Example</b>	:SOUR:FREQ:CHAN:BAND BANDF
Initial S/W Revision	A.11.50

#### Radio Band Link

Allows you to specify the radio band link direction for the steps within the list sequence. The link is used in conjunction with the channel band and channel number to determine the output frequency.

When set to “Uplink”, the source will calculate the uplink frequency according to an uplink formula together with selected channel band and channel number. When set to “Downlink”, the source will calculate the downlink frequency according to a downlink formula together with selected channel band and channel number.

Key Path	Source, List Sequencer, List Sequencer Setup, Radio Setup
<b>Remote Command</b>	:SOURce:LIST:STEP[1] 2 3...1000:SETup:RADio:BAND:LINK DOWN UP :SOURce:LIST:STEP[1] 2 3...1000:SETup:RADio:BAND:LINK?
<b>Example</b>	:SOUR:LIST:STEP2:SET:RAD:BAND:LINK UP :SOUR:LIST:STEP2:SET:RAD:BAND:LINK?
Notes	SCPI is supported after A.09.40
Preset	DOWN
Range	DOWN   UP
Initial S/W Revision	A.05.00

## Channel

Allows you to specify the frequency of the current step via a channel number.

<b>Key Path</b>	Source, List Sequencer, List Sequencer Setup
<b>Remote Command</b>	:SOURce:LIST:STEP[1] 2 3...1000:SETup:CNFRrequency <double> :SOURce:LIST:STEP[1] 2 3...1000:SETup:CNFRrequency?
<b>Example</b>	:SOUR:LIST:STEP2:SET:CNFR 124 :SOUR:LIST:STEP2:SET:CNFR?
<b>Notes</b>	SCPI is supported after A.09.40. This SCPI is used to setup channel number or frequency setting, according to current Radio Band setting. If Radio Band is "NONE", then it's frequency. If Radio Band is not "NONE", then it's channel number.
<b>Couplings</b>	The channel number is coupled to the step frequency value. When the step frequency value is changed, the channel number will increase or decrease to match the new step frequency. If the step frequency is not at an exact match for a channel number, the nearest channel number is displayed, along with a greater than, or less than sign to indicate the frequency is above or below the channel number.
<b>Preset</b>	1
<b>Min</b>	0 (Please refer to for valid ranges.)
<b>Max</b>	10838 (Please refer to for valid ranges.)
<b>Initial S/W Revision</b>	A.05.00

## Frequency

Allows you to specify a frequency value for the current step.

<b>Key Path</b>	Source, List Sequencer, List Sequencer Setup
<b>Remote Command</b>	:SOURce:LIST:STEP[1] 2 3...1000:SETup:CNFRrequency <double> :SOURce:LIST:STEP[1] 2 3...1000:SETup:CNFRrequency?
<b>Example</b>	:SOUR:LIST:STEP2:SET:CNFR 1GHz :SOUR:LIST:STEP2:SET:CNFR?
<b>Notes</b>	SCPI is supported after A.09.40. This SCPI is used to setup channel number or frequency setting, according to current Radio Band setting. If Radio Band is "NONE", then it's frequency. If Radio Band is not "NONE", then it's channel number.
<b>Couplings</b>	The frequency value is coupled to the channel band and number for the step, such that updates to the radio band and channel number will update the frequency value to the corresponding absolute frequency. The reverse is also true, changing the frequency value causes the value of the channel number to be updated.
<b>Preset</b>	1.00 GHz
<b>Min</b>	10.00 MHz
<b>Max</b>	Hardware Dependant:

	Option 503 = 3.6 GHz Option 504 = 3.9 GHz Option 506 = 6.00 GHz
Initial S/W Revision	A.05.00

## Power

Allows you to specify a power value for the current step.

Key Path	Source, List Sequencer, List Sequencer Setup
Remote Command	:SOURce:LIST:STEP[1] 2 3...1000:SETup:AMPLitude <double> :SOURce:LIST:STEP[1] 2 3...1000:SETup:AMPLitude?
Example	:SOUR:LIST:STEP2:SET:AMPL -50dBm :SOUR:LIST:STEP2:SET:AMPL?
Notes	SCPI is supported after A.09.40
Notes	Amplitude corrections can be specified for use with the source. In the event of amplitude corrections being applied, the valid ranges for the RF power do not change dependant on the current amplitude correction setting. Instead, if the combination of RF power + amplitude correction is higher or lower than the source output range, the Source Unleveled bit is set and the "Source Unleveled" indicator will appear on status panel to indicate that the source cannot maintain the output power that has been requested.  The multiport adapter RFIO TX ports and GPS ports cannot ensure power accuracy when power setting is lower than -130dBm, this power setting value is defined by the sum of RF Power setting and related amplitude correction value. But user settable value could be lower than this limit. When application detected there exists power setting lower than -130dBm on MPA RFIO TX ports, then popup warning message . When application detected there exists power setting lower than -130dBm on MPA GPS ports, then popup warning message . These are only warning messages, and check is performed when RF is ON.
Notes	The Min and Max value here defined UI settable amplitude range. This range is larger than actual amplitude range with level accuracy defined in spec.
Dependencies	The RF power is dependent on the RF output port and frequency, such that the current frequency and selected output port determine the valid range of power values.
Preset	-100 dBm
Min	The range of values depends on the current frequency and selected RF output port. Please refer to "RF Power" on page 1379 and the table RF Power Range for the valid ranges.
Max	The range of values depends on the current frequency and selected RF output port. Please refer to "RF Power" on page 1379 and the table RF Power Range for the valid ranges.
Initial S/W Revision	A.05.00

## Waveform

Allows you access to the sub-menus for selecting the waveform to be played back during the current step. Pressing this key also changes the central display area to show the Waveform File Selection view.

Key Path	Source, List Sequencer, List Sequencer Setup
Remote Command	:SOURce:LIST:STEP[1]   2   3...1000:SETup:WAVeform <string> :SOURce:LIST:STEP[1]   2   3...1000:SETup:WAVeform?
Example	:SOUR:LIST:STEP2:SET:WAV "CW" :SOUR:LIST:STEP2:SET:WAV?
Notes	SCPI is supported after A.09.40
Remote Command Notes	String type, takes "Off"   "CW"   "Cont"   "waveform name"
Preset	CW
Range	Waveform   Continue Previous   CW   Off
Initial S/W Revision	A.05.00

### CW

Sets the current step to output a CW tone.

Key Path	Source, List Sequencer, List Sequencer Setup, Waveform
Example	:SOUR:LIST:STEP2:SET:WAV "CW"
Notes	SCPI is supported after A.09.40
Initial S/W Revision	A.05.00

### Selected Waveform

Inserts the currently selected waveform in the waveform selection view as the waveform for playback during the current step.

Key Path	Source, List Sequencer, List Sequencer Setup, Waveform
Example	:SOUR:LIST:STEP2:SET:WAV "waveform name"
Notes	SCPI is supported after A.09.40 If the selected waveform contains header (which contains ARB play parameters), source list sequence will automatically apply header settings of the selected waveform in that step.
Initial S/W Revision	A.05.00

### Continue Previous

Sets the current step to continue with playback of the waveform from the previous step. When continuing the previous waveform, the ARB playback will not pause while the source retunes to the new frequency or amplitude that may be defined for the new step.

Key Path	Source, List Sequencer, List Sequencer Setup, Waveform
----------	--------------------------------------------------------

<b>Example</b>	:SOUR:LIST:STEP2:SET:WAV "Cont"
<b>Notes</b>	SCPI is supported after A.09.40
<b>Initial S/W Revision</b>	A.05.00

#### Off

Disable RF output of the current step.

<b>Key Path</b>	Source, List Sequencer, List Sequencer Setup, Waveform
<b>Example</b>	:SOUR:LIST:STEP2:SET:WAV "Off"
<b>Notes</b>	SCPI is supported after A.09.40
<b>Initial S/W Revision</b>	A.05.00

#### Segments on Hard Disk

Allows you access to the sub-menus for loading waveform segments from the hard disk into ARB memory. The default directory is: D: varb.

Pressing this key changes the current view to the Waveform Management View.

<b>Key Path</b>	Source, Modulation Setup, ARB, Select Waveform
<b>Initial S/W Revision</b>	A.05.00

#### Load Segment To ARB Memory

Allows you to load the selected file into ARB memory. On the front panel you select the file for loading to the ARB memory by highlighting the desired file in the list. Using the SCPI command, you specify the file name on the HDD.

"NVWFM" (none-volatile storage) MSUS (Mass Storage Unit Specifier) is supported in the memory subsystem because the ARB memory cannot be accessed directly. Therefore, files must be downloaded to the instrument hard disk and then loaded into the ARB memory. "NVWFM" MSUS will be mapped to the default directory D: VARB. The SCPI command supports using either "NVWFM" MSUS or specifying a full path. For more information, see Memory Subsystem (Remote Command Only).

If a file of the same name already exists within ARB memory, it is overwritten. If you wish to load two segments of the same name, you must rename one of the segments before loading it into ARB memory. To rename a segment, you can either use Windows File Explorer, or the :MMEMORY:COPY command.

NOTE: When a waveform file is loaded to ARB memory, burst timing adjustments are made automatically, based on whether or not a Multiport Adapter is connected to the test set and powered on. If the connection/power status of the Multiport Adapter is changed after a waveform file has been loaded, it needs to be loaded again.

Key Path	Source, Modulation Setup, ARB, Select Waveform, Segments on Hard Disk
Remote Command	:SOURce:RADio:ARB:LOAD <string>
Example	:SOUR:RAD:ARB:LOAD "D: VARB\testwaveform.bin" or :SOUR:RAD:ARB:LOAD "NVWFM:testwaveform.bin"
Notes	<p>Because loading the file involves a delay of unpredictable length, this command should be followed by the query *OPC?, which holds off subsequent commands until the loading operating is complete.</p> <p>&lt;string&gt; – specifies the path name of the file to load from the HDD into ARB memory. It could be a &lt;full path + filename&gt;, or &lt;"NVWFM" MSUS + colon + filename&gt;.</p> <p>When in Sequence Analyzer mode, and Include Source is Yes, an attempt to load a file to ARB memory will be rejected with an error.</p> <p>When Include Source is No and if there is insufficient free ARB memory to load the selected waveform, an error is generated. .</p> <p>If you specify a file over SCPI, but the file is not at the specified location, an error is generated.</p> <p>If you try to load a waveform file but the file contains less than 500 IQ samples, an error is generated.</p> <p>If you try to load a Signal Studio waveform "*.wfm" which contains invalid waveform header, an error is generated.</p> <p>If the ARB is ON when you load a file to ARB memory or delete a file from ARB memory, the playing waveform segment may not keep phase continuity during the ARB memory operation. The waveform will be replayed after the ARB operation is finished.</p> <p>ARB can be loaded into ARB memory even required licenses do not present on the instrument. In this case, a GUI only warning message -800, "Operation complete; Loaded &lt;filename&gt; successfully, but no license &lt;required licenses&gt; installed". User can install required licenses according to &lt;required licenses&gt; string to license it, or multi-pack license it.</p>
Initial S/W Revision	A.05.00

### Load All To ARB Memory

Allows you to load all the segment files within the currently selected directory into ARB memory. If a file of the same name already exists within ARB memory, it is overwritten. If you wish to load two segments of the same name, you must rename one of the segments before loading it into ARB memory. To rename a segment, you can either use Windows File Explorer, or the :MEMory:COPI command.

NOTE: When a waveform file is loaded to ARB memory, burst timing adjustments are made automatically, based on whether or not a Multiport Adapter is connected to the test set and powered on. If the connection/power status of the Multiport Adapter is changed after a waveform file has been loaded, it needs to be loaded again.

Key Path	Source, Modulation Setup, ARB, Select Waveform, Segments on Hard Disk
Remote Command	:SOURce:RADio:ARB:LOAD:ALL <string>
Example	:SOUR:RAD:ARB:LOAD:ALL "D: varb"
Notes	<p>&lt;string&gt; - specifies the directory on the HDD to load the files into ARB memory from.</p> <p>When in Sequence Analyzer mode, and Include Source is Yes, an attempt to load all files from a directory to ARB memory is rejected with an error.</p>

When Include Source is No and there is insufficient free ARB memory to load all the waveforms, when the ARB memory is full, the copy ceases, and an error is generated.  
If you specify a directory over SCPI, but the directory does not exist, an error is generated.  
If the ARB is ON, a user then loads or deletes file to ARB memory, the playing waveform segment may not keep phase continuity during the ARB memory operation. The waveform will be replayed after the ARB operation is finished.

Initial S/W Revision	A.05.00
----------------------	---------

### Change Directory...

Allows you to change the currently selected directory on the hard disk. Pressing this key opens a standard windows change directory dialog allowing you to select the new directory of interest.

The current directory is used for manually loading waveform segments into ARB memory for playback, and as a search location for waveform segments that are required to be loaded into ARB memory for playback of a waveform sequence or a list sequence.

Key Path	Source, Modulation Setup, ARB, Select Waveform, Segments on Hard Disk
Notes	No remote command, SCPI front panel only.
Initial S/W Revision	A.05.00

### Default Directory...

Allows you to change the default directory. It is used as a search location for waveform segments that are required to be loaded into ARB memory for playback of a waveform sequence, and as a search location for selecting waveforms using SCPI.

Key Path	Source, Modulation Setup, ARB, Select Waveform, Segments on Hard Disk
<b>Remote Command</b>	:SOURce:RADio:ARB:DEFault:DIRectory <string> :SOURce:RADio:ARB: DEFault:DIRectory?
<b>Example</b>	:SOUR:RAD:ARB:DEF:DIR "D:\ArbFiles" :SOUR:RAD:ARB:DEF:DIR?
State Saved	Persistent, survives a power cycle and a preset but not saved in the instrument state
Initial S/W Revision	A.05.00

### Segments in ARB Memory

Allows you access to the sub-menus for managing the files within ARB memory.

Key Path	Source, Modulation Setup, ARB, Select Waveform
Initial S/W Revision	A.05.00



## Delete Segment From ARB Mem

Allows you to remove a segment from ARB playback memory.

Key Path	Source, Modulation Setup, ARB, Select Waveform, Segments in ARB Memory
Remote Command	:SOURce:RADio:ARB:DELeTe <string>
Example	:SOUR:RAD:ARB:DEL "testwaveform.bin"
Notes	<p>&lt;string&gt; - specifies the waveform to be deleted from the ARB playback memory.</p> <p>When in Sequence Analyzer mode and Include Source is Yes, an attempt to delete a file from ARB memory is rejected with an error.</p> <p>When Include Source is No and you specify a file that does not exist within ARB memory, an error is generated.</p> <p>It is possible to delete files from within the ARB memory when the ARB is ON. However, if you attempt to delete the file that is currently playing an error is generated.</p> <p>It is possible to delete a file from within the ARB memory when the sequencer state is ON and the file is not being used by the List Sequencer. If you attempt to delete a file which is being used by the list sequencer, an error is generated.</p> <p>When sequencer state is On, even if ARB state is On, the selected waveform will not be played. In this case, if the selected waveform is not used in List Sequence, it can be deleted and the ARB state is turned Off.</p> <p>If the ARB is ON and you load a file to ARB memory or delete a file from ARB memory, the playing waveform segment may not keep phase continuity during the ARB memory operation. The waveform will be replayed after the ARB operation is finished.</p>
Initial S/W Revision	A.05.00

## Delete All From ARB Memory

Allows you to remove all segments from ARB playback memory.

Key Path	Source, Modulation Setup, ARB, Select Waveform, Segments in ARB Memory
Remote Command	:SOURce:RADio:ARB:DELeTe:ALL
Example	:SOUR:RAD:ARB:DELeTe:ALL
Notes	<p>When in Sequence Analyzer mode and Include Source is Yes, an attempt to delete all files from ARB memory is rejected with an error.</p> <p>When Include Source is No and you attempt to delete all files from ARB memory when the ARB is currently playing a file, all files except the one playing are deleted and an error is generated.</p> <p>If you attempt to delete all files from ARB memory when there are waveform files used in "<a href="#">List Sequencer</a>" on page 1449 and "<a href="#">Sequencer</a>" on page 1449 state is ON, all files except the files currently being used in list sequencer are deleted, and an error is generated.</p> <p>If the ARB is ON and you load a file to ARB memory or delete a file from ARB memory, the playing waveform segment may not keep phase continuity during the ARB memory operation. The waveform will be replayed after the ARB operation is finished.</p>
Initial S/W Revision	A.05.00

## Step Duration

Allows access to the sub-menus for setting up the duration of play for the current step.

The duration can be set to be either the number of times for the ARB file associated with the sequence to play, or a specific time value, or continuous. If the step is set to play a CW tone, the step duration cannot be set to a play count.

<b>Key Path</b>	Source, List Sequencer, List Sequencer Setup
<b>Remote Command</b>	:SOURce:LIST:STEP[1] 2 3...1000:SETup:DURation:TYPE TIME   COUNT   CONTinuous   CABort  :SOURce:LIST:STEP[1] 2 3...1000:SETup:DURation:TYPE?
<b>Example</b>	:SOUR:LIST:STEP2:SET:DUR:TYPE TIME :SOUR:LIST:STEP2:SET:DUR:TYPE?
<b>Notes</b>	SCPI is supported after A.09.40
<b>Notes</b>	If “Step Duration” is set to “Time” or “Play Count” for the last step, the last step of ARB keeps playing as if set to “Continuous”, until the set “Time” has expired or until the “Play Count” setting is reached. However, you can query <b>Error! Reference source not found.</b> Source Sweeping Condition Message to find out if the current list sequence is complete or not.
<b>Range</b>	Time   Play Count   Continuous   Continuous Abort
<b>Initial S/W Revision</b>	A.05.00

## Time

Sets the duration of the current step to be a time value for the length of time the step will play. Pressing this key again opens another menu which allows you to set the time value for the step duration.

<b>Key Path</b>	Source, List Sequencer, List Sequencer Setup, Step Duration
<b>Example</b>	:SOUR:LIST:STEP2:SET:DUR:TYPE TIME
<b>Notes</b>	SCPI is supported after A.09.40
<b>Initial S/W Revision</b>	A.05.00

## Duration Time

Allows you to specify the length of time the current step will play.

If the Transition Time value is longer than the Step Duration Time, an error is generated when initiating a source list sequence. For source list sequence, transition time is included in the step duration length (not occupy additional time). If the Transition Time value is longer than the Step Duration Time, the real step duration length is extended to equal the transition time and cause a timing shift. This check is also described in section **Error! Reference source not found.** List Sequence Step Validation.

<b>Key Path</b>	Source, List Sequencer, List Sequencer Setup, Step Duration, Time
<b>Remote Command</b>	:SOURce:LIST:STEP[1] 2 3...1000:SETup:DURation:TCOUNT <double> :SOURce:LIST:STEP[1] 2 3...1000:SETup:DURation:TCOUNT?

<b>Example</b>	:SOUR:LIST:STEP2:SET:DUR:TCO 1s :SOUR:LIST:STEP2:SET:DUR:TCO?
Notes	SCPI is supported after A.09.40 This SCPI is reused by "Play Count", "Duration Time" and "Continuous Abort" according to current Duration Type setting is "Play Count" or "Duration Time" or "Continuous Abort". If current "Duration Type" is "Continuous", then popup error -221, "Settings conflict; Cannot accept time or count input when step duration type is Continuous on step #"
Notes	If "Duration Time" is set for the last step, the last step of ARB keeps playing as if set to "Continuous" after set time expires. However, you can query Source Sweeping Condition Message (:STAT:OPER:COND?) to find out if the current list sequence is complete or not.
Preset	1.00 ms
Min	100 $\mu$ s
Max	1800 s
Initial S/W Revision	A.05.00

### Play Count

Sets the duration of the current step to be an integer value for the number of times (play count) the ARB file is selected for playback during this step. For example, a 5 second ARB will be set to play 5 times during the step.

<b>Key Path</b>	Source, List Sequencer, List Sequencer Setup, Step Duration
<b>Example</b>	:SOUR:LIST:STEP2:SET:DUR:TYPE COUN
Notes	SCPI is supported after A.09.40 This key is unavailable and is grayed out if the current step is configured to CW tone rather than an ARB waveform.
Initial S/W Revision	A.05.00

### Header Utilities

Allows access to the header utilities sub-menu. Pressing this key also causes the central display area to change to display the File Header Information view.

<b>Key Path</b>	Source, Modulation Setup, ARB
Dependencies	This key is only available if there is currently a waveform selected for playback. If no waveform is selected, the key is grayed out.
Initial S/W Revision	A.05.00

### Continuous

Sets the current step to be played continuously until the next step starts. The waveform will always play completely before transitioning to the next step.

<b>Key Path</b>	Source, List Sequencer, List Sequencer Setup, Step Duration
<b>Example</b>	:SOUR:LIST:STEP2:SET:DUR:TYPE CONT
<b>Notes</b>	SCPI is supported after A.09.40
<b>Initial S/W Revision</b>	A.05.00

### Output Trigger

Allows you to specify the trigger output for the current step. The trigger output signal is sent at the start of the step.

When select “On”, trigger event will occur on both Internal and External2 paths. Select “Off” will turn off trigger output.

<b>Key Path</b>	Source, List Sequencer, List Sequencer Setup
<b>Remote Command</b>	:SOURce:LIST:STEP [1]   2   3...1000:SETup:OUTPut:TRIGger ON   OFF   1   0 :SOURce:LIST:STEP [1]   2   3...1000:SETup:OUTPut:TRIGger
<b>Example</b>	:SOUR:LIST:STEP2:SET:OUTP:TRIG ON :SOUR:LIST:STEP2:SET:OUTP:TRIG?
<b>Notes</b>	SCPI is supported after A.09.40
<b>Preset</b>	Off
<b>Range</b>	On Off
<b>Initial S/W Revision</b>	A.05.00

### Repetition

Allows access to the sub-menu for selecting the repetition type for the list sequencer globally. It cannot be changed between different sequence steps.

<b>Key Path</b>	Source, List Sequencer
<b>Remote Command</b>	:SOURce:LIST:REPetition:TYPE SINGLE CONTInuous
<b>Example</b>	:SOUR:LIST:REP:TYPE SING :SOUR:LIST:REP:TYPE?
<b>Preset</b>	SINGLE
<b>Range</b>	SINGLE CONTInuous
<b>Initial S/W Revision</b>	A.14.50

### Single

Sets the repetition type as single for the whole source sequence. Source list will play one time after initiation.

Key Path	Source, List Sequencer, Repetition
<b>Example</b>	:SOUR:LIST:REP:TYPE SINGLE
Initial S/W Revision	A.14.50

### Continuous

Sets the repetition type as continuous for the whole source sequence. Source list will play continuously after initiation.

Key Path	Source, List Sequencer, Repetition
<b>Example</b>	:SOUR:LIST:REP:TYPE CONTINUOUS
Initial S/W Revision	A.14.50

### Trigger Type

Allows access to the sub-menu for selecting the output trigger type for the list sequencer globally. It cannot be changed between different sequence steps.

Key Path	Source, List Sequencer
<b>Remote Command</b>	:SOURce:LIST:TRIGgerout:TYPE BEGinningofstep DATAmarker
<b>Example</b>	:SOUR:LIST:TRIG:TYP BEG :SOUR:LIST:TRIG:TYP?
Notes	SCPI is supported after A.14.00
Preset	BEGinningofstep
Range	BEGinningofstep DATAmarker
Initial S/W Revision	A.14.00

### BeginningOfStep

Sets the output trigger type as BeginningOfStep for the whole source sequence.

Key Path	Source, List Sequencer, Trigger Type
<b>Example</b>	:SOUR:LIST:TRIG:TYP BEG
Notes	SCPI is supported after A.14.00
Initial S/W Revision	A.14.00

## DataMarker

Sets the output trigger type as DataMarker for the whole source sequence. When DataMarker is selected, which marker to route is also needed to be set.

Key Path	Source, List Sequencer, Trigger Type
<b>Example</b>	:SOUR:LIST:TRIG:TYP DAT
Notes	SCPI is supported after A.14.00
Initial S/W Revision	A.14.00

## Marker 1

Sets the output trigger maker routing to Marker 1 for DataMarker in the whole source sequence.

Key Path	Source, List Sequencer, Trigger Type, DataMarker
<b>Example</b>	:SOUR:LIST:TRIG:TYPE:MARK M1
Notes	SCPI is supported after A.14.00
Initial S/W Revision	A.14.00

## Marker 2

Sets the output trigger maker routing to Marker 2 for DataMarker in the whole source sequence.

Key Path	Source, List Sequencer, Trigger Type, DataMarker
<b>Example</b>	:SOUR:LIST:TRIG:TYPE:MARK M2
Notes	SCPI is supported after A.14.00
Initial S/W Revision	A.14.00

## Marker 3

Sets the output trigger maker routing to Marker 3 for DataMarker in the whole source sequence.

Key Path	Source, List Sequencer, Trigger Type, DataMarker
<b>Example</b>	:SOUR:LIST:TRIG:TYPE:MARK M3
Notes	SCPI is supported after A.14.00
Initial S/W Revision	A.14.00

### Marker 4

Sets the output trigger maker routing to Marker 4 for DataMarker in the whole source sequence.

Key Path	Source, List Sequencer, Trigger Type, DataMarker
<b>Example</b>	:SOUR:LIST:TRIG:TYPE:MARK M4
Notes	SCPI is supported after A.14.00
Initial S/W Revision	A.14.00

### Manual Trigger Now

Pressing this key provides a software trigger event to the list sequencer. During execution of sequence, if the sequencer is halted on any step that has been configured with a “Manual” step trigger, then this key press will cause the sequencer to continue and execute the step.

Key Path	Source, List Sequencer
<b>Remote Command</b>	No remote command, front panel only.
Initial S/W Revision	A.05.00

### Source Preset

Allows you to preset the source settings to their default values.

Key Path	Source
<b>Remote Command</b>	:SOURce:PRESet
<b>Example</b>	:SOUR:PRES

## SPAN X Scale

Accesses a menu of functions that enable you set the horizontal scale parameters.

Key Path	Front-panel key
Initial S/W Revision	Prior to A.02.00

### Span

Changes the frequency range symmetrically about the center frequency.

The default (and minimum) span is calculated using the number of carriers and the carrier width where;

$$\text{Span} = (\text{Upper Carrier Freq} + (\text{max offset IBW} * (1 + \alpha)) / 2) - (\text{Lower Carrier Freq} - (\text{max offset IBW} * (1 + \alpha)) / 2)$$

The span is increased by a factor of 1 + Filter Alpha if the RRC Filter is on.

Key Path	SPAN X Scale
Mode	SA, WCDMA, C2K, WIMAX OFDMA, TD-SCDMA, 1xEVDO, DVB-T/H, DTMB (CTTB), ISDB-T, CMMB, LTE, LTE-TDD, Digital Cable TV, MSR, LTEAFDD, LTEATDD
Remote Command	[ :SENSe ] :ACPowEr:FREQuency:SPAN <freq> [ :SENSe ] :ACPowEr:FREQuency:SPAN?
Example	ACP:FREQ:SPAN 25MHz ACP:FREQ:SPAN?
Notes	You must be in the mode that includes ACP measurements to use this command. Use :INSTrument:SElect to set the mode.
Couplings	The span value is clipped when the carrier settings and/or the offset settings are changed. The value is changed to satisfy following formula: $\text{Span} = (\text{Upper Carrier Freq} + (\text{max offset IBW} * (1 + \alpha)) / 2) - (\text{Lower Carrier Freq} - (\text{max offset IBW} * (1 + \alpha)) / 2)$
Preset	SA: 8 MHz WCDMA: 24.6848 MHz WIMAX OFDMA: 50 MHz C2K: 4.5 MHz TD-SCDMA: 8 MHz 1xEVDO: 4.05 MHz DVB-T/H: 40 MHz DTMB (CTTB): 72 MHz ISDB-T: 30 MHz CMMB: 72 MHz LTE, LTE-TDD, MSR: 25 MHz Digital Cable TV: 40 MHz LTEAFDD, LTEATDD: 25MHz



State Saved	Saved in instrument state.
Min	10 Hz
Max	Hardware Dependent: Option F03 = 3.0 GHz Option F07 = 7.5 GHz Option F13 = 13.6 GHz Option F26 = 26.5 GHz
Initial S/W Revision	Prior to A.02.00
Modified at S/W Revision	A.02.00, A.03.00

## Full Span

Changes the span to show the full frequency range of the spectrum analyzer.

Key Path	SPAN X Scale
Mode	SA, WCDMA, C2K, WiMAX OFDMA, TD-SCDMA, 1xEVDO, DVB-T/H, DTMB (CTTB), ISDB-T, CMMB, LTE, LTE-TDD, Digital Cable TV
<b>Remote Command</b>	[ :SENSe ] :ACPower:FREQuency:SPAN:FULL
<b>Example</b>	ACP:FREQ:SPAN:FULL
Notes	You must be in the mode that includes ACP measurements to use this command. Use :INSTrument:SElect to set the mode.
Dependencies	For MSR and LTE-Advanced FDD/TDD mode, this key is blank.
Initial S/W Revision	Prior to A.02.00
Modified at S/W Revision	A.02.00, A.03.00

## Last Span

Changes the span to the previous span setting. If no previous span value exists, then the span will remain unchanged.

Key Path	SPAN X Scale
Mode	SA, WCDMA, C2K, WiMAX OFDMA, TD-SCDMA, 1xEVDO, DVB-T/H, DTMB (CTTB), ISDB-T, CMMB, LTE, LTE-TDD, Digital Cable TV, MSR, LTEAFDD, LTEATDD
<b>Remote Command</b>	[ :SENSe ] :ACPower:FREQuency:SPAN:PREVious
<b>Example</b>	ACP:FREQ:SPAN:PREV
Notes	You must be in the mode that includes ACP measurements to use this command. Use :INSTrument:SElect to set the mode.
Initial S/W Revision	Prior to A.02.00
Modified at S/W Revision	A.02.00, A.03.00

## Sweep/Control

Accesses a menu of functions that enable you to set up and control the sweep time, and source.

See Key and Command Descriptions – Sweep/Control for more information.

Key Path	Front-panel key
Initial S/W Revision	Prior to A.02.00

### Sweep Time

Selects the length of time in which the spectrum analyzer sweeps the displayed frequency span. In swept spans, the sweep time varies from 1 millisecond to 2000 seconds. Additional overhead time, which impacts the sweep rate, is not calculated as part of the sweep time. In fact:

sweep rate = span/sweep time

update rate = 1/(sweep time + overhead)

sweep cycle time = sweep time + overhead

Sweep time is coupled to RBW and VBW, and is impacted by the number of sweep points, so changing those parameters may change the sweep time.

If you increase the sweep time, you increase the length of the time data captured and the number of points measured. You might need to specify a specific sweep speed to accommodate a specific condition in your transmitter. For example, you may have a burst signal and need to measure an exact portion of the burst.

Selecting a specific sweep time may result in a long measurement time since the resulting number of data points may not be the optimum  $2n$ . Use [:SENSe]:ACP:OFFSet:LIST:SWEEp:TIME to set the number of points used for measuring the offset channels for Basic and cdmaOne.

For cdma2000 and W-CDMA, this command sets the sweep time when using the sweep mode. See [:SENSe]:ACP:SWEEp:TYPE

Key Path	Sweep/Control
Mode	SA, WCDMA, C2K, WIMAX OFDMA, TD-SCDMA, 1xEVDO, DVB-T/H, DTMB (CTTB), ISDB-T, CMMB, LTE, LTETDD, Digital Cable TV, MSR, LTEAFDD, LTEATDD
Remote Command	[:SENSe]:ACP:SWEEp:TIME <time> [:SENSe]:ACP:SWEEp:TIME? [:SENSe]:ACP:SWEEp:TIME:AUTO OFF ON 0 1 [:SENSe]:ACP:SWEEp:TIME:AUTO?
Example	ACP:SWEEp:TIME 50ms ACP:SWEEp:TIME? ACP:SWEEp:TIME:AUTO OFF ACP:SWEEp:TIME:AUTO?
Notes	This parameter is preset by Meas Method selection. Preset values are as follows:

	IBW: 29 ms IBWR: 108 ms FAST (WCDMA): 7.5 ms
Preset	SA, LTE, LTETDD, MSR: Automatically calculated WCDMA: 29 ms WIMAX OFDMA: Automatically calculated C2K: Automatically calculated TD-SCDMA: Automatically calculated 1xEVDO: Automatically calculated DVB-T/H: Automatically calculated DTMB (CTTB): Automatically calculated ISDB-T: Automatically calculated CMMB: Automatically calculated Digital Cable TV: Automatically calculated LTEAFDD, LTEATDD: Automatically calculated SA, LTE, LTETDD, MSR, LTEAFDD, LTEATDD: ON WCDMA: OFF C2K: OFF (method IBW) WIMAX OFDMA: ON TD-SCDMA: ON DVB-T/H: ON DTMB (CTTB): ON ISDB-T: ON CMMB: ON Digital Cable TV: ON
State Saved	Saved in instrument state.
Min	1 ms
Max	4000 s
Initial S/W Revision	Prior to A.02.00
Modified at S/W Revision	A.02.00, A.03.00

## Sweep Setup

Accesses the sweep setup menu.

Key Path	Sweep/Control
Initial S/W Revision	Prior to A.02.00

## Auto Sweep Time Rules

Switches the analyzer between normal and accuracy sweep states.

Key Path	Sweep/Control, Sweep Setup
Mode	SA, WCDMA, C2K, WIMAX OFDMA, TD-SCDMA, 1xEVDO, DVB-T/H, DTMB (CTTB), ISDB-T, CMMB, LTE, LTETDD, Digital Cable TV, MSR, LTEAFDD, LTEATDD
Remote Command	[ :SENSe ] :ACPoweR :SWEep :TIME :AUTO :RULes NORMal   ACCuracy [ :SENSe ] :ACPoweR :SWEep :TIME :AUTO :RULes?
Example	ACP:SWE:TIME:AUTO:RUL NORM ACP:SWE:TIME:AUTO:RUL?
Notes	Set to Norm when Auto Couple is pressed or sent remotely.
Preset	SA, WCDMA, C2K, TD-SCDMA, 1xEVDO, DTMB (CTTB), LTE, LTETDD, MSR, LTEAFDD, LTEATDD: ACCuracy WIMAX OFDMA, DVB-T/H: NORMal ISDB-T, CMMB: NORMal Digital Cable TV: NORMal
State Saved	Saved in instrument state.
Range	Norm Accy
Initial S/W Revision	Prior to A.02.00
Modified at S/W Revision	A.02.00, A.03.00

## Pause

Pauses a measurement after the current data acquisition is complete. When Paused, the label on the key changes to Resume. Pressing the Resume key resumes the measurement at the point where it was paused. When Paused, pressing Restart, Single, or Cont does a Resume

See Pause/Resume for more details.

Key Path	Sweep/Control
Initial S/W Revision	Prior to A.02.00

## Gate

Accesses a menu that enables you to control the gating function. The Gate functionality is used to view signals best viewed by qualifying them with other events.

Gate setup parameters are the same for all measurements – they do not change as you change measurements. Settings like these are called “Meas Global” and are unaffected by Meas Preset.

Key Path	Sweep/Control
Scope	Meas Global

Readback	The state and method of Gate, as [Off, FFT] or [On, FFT]. Note that for measurements that only support gated FFT, the method is nonetheless read back, but always as FFT.
Initial S/W Revision	Prior to A.02.00

## Gate On/Off

Turns the gate function on and off.

When the Gate Function is on, the selected Gate Method is used along with the gate settings and the signal at the gate source to control the sweep system with the gate signal. Not all measurements allow every type of Gate Methods.

When Gate is on, the annunciation in the measurement bar reflects that it is on and what method is used, as seen in the following "Gate: FFT" annunciator graphic.

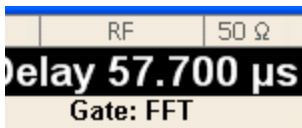

Key Path	Sweep/Control, Gate
Remote Command	[ :SENSe ] :SWEep:EGATe [ :STATe ] OFF ON 0 1 [ :SENSe ] :SWEep:EGATe [ :STATe ] ?
Example	SWE:EGAT ON SWE:EGAT?
Dependencies	When in the ACP measurement: <ul style="list-style-type: none"> <li>• When Meas Method is RBW or FAST, this function is unavailable and the key is grayed out.</li> <li>• Whenever Gate is on, Meas Method, RBW or FAST is unavailable and keys for those are grayed out.</li> <li>• When Gate is on, Offset Res BW and Offset Video BW are ignored (if you set these values) and the measurement works as if all Offset Res BW and all Offset Video BW are coupled with the Res BW and the Video BW under the BW menu. When Gate is on, the Offset BW key in the Offset/Limit menu is grayed out.</li> </ul>
Preset	Off LTETDD: On
State Saved	Saved in instrument state
Range	On Off
Backwards Compatibility SCPI	[ :SENSe ] :SWEep:TIME:GATE [ :STATe ] ESA compatibility
Backwards Compatibility Notes	In ESA, Trig Delay (On) and Gate (On) could not be active at the same time.. This dependency does not exist in PSA or in the X-Series.

---

Initial S/W Revision      Prior to A.02.00

---

## Gate View On/Off

Turning on Gate View in the Swept SA measurement provides a single-window gate view display..

Turning on Gate View in other measurements shows the split-screen Gate View. In these measurements, when the Gate View is on, the regular view of the current measurement traces and results are reduced vertically to about 70% of the regular height. The Zero Span window, showing the positions of the Gate, is shown between the Measurement Bar and the reduced measurement window. By reducing the height of the measurement window, some of the annotation on the Data Display may not fit and is not shown.

<b>Key Path</b>	Sweep/Control, Gate
<b>Remote Command</b>	[ :SENSe ] :SWEep:EGATe:VIEW ON OFF 1 0 [ :SENSe ] :SWEep:EGATe:VIEW?
<b>Example</b>	SWE:EGAT:VIEW ON turns on the gate view.
<b>Dependencies</b>	In the Swept SA measurement: In Gate View, the regular Acq Time key is grayed out . When pressed, the grayed out key puts up the informational message "Use Gate View Sweep Time in the Gate menu." In the other measurements: When you turn Gate View on, the lower window takes on the current state of the instrument. Upon leaving Gate View, the instrument takes on the state of the lower window. When you turn Gate View on, the upper window Acquisition Time is set to the gate view acquisition time.
<b>Couplings</b>	These couplings apply to the Swept SA measurement: <ul style="list-style-type: none"> <li>• When Gate View is turned on, the instrument is set to Zero Span.</li> <li>• Gate View automatically turns off whenever a Span other than Zero is selected.</li> <li>• Gate View automatically turns off if you press the Last Span key while in Gate View, and the instrument returns to the Span it was in before entering Gate View (even if that is Zero Span).</li> <li>• When Gate View is turned on, the sweep time used is the gate view sweep time. This is set according to the rules in section "<a href="#">Gate View Setup</a> " on page 1157</li> <li>• When Gate View is turned off, Sweep Time is set to the normal Swept SA measurement sweep time.</li> <li>• If Gate View is on and Gate is off, then turning on Gate turns off Gate View.</li> </ul>
<b>Preset</b>	OFF
<b>State Saved</b>	Saved in instrument state
<b>Range</b>	On Off
<b>Initial S/W Revision</b>	Prior to A.02.00

A sample of the Gate View screen in the Swept SA measurement is shown in the following graphic :

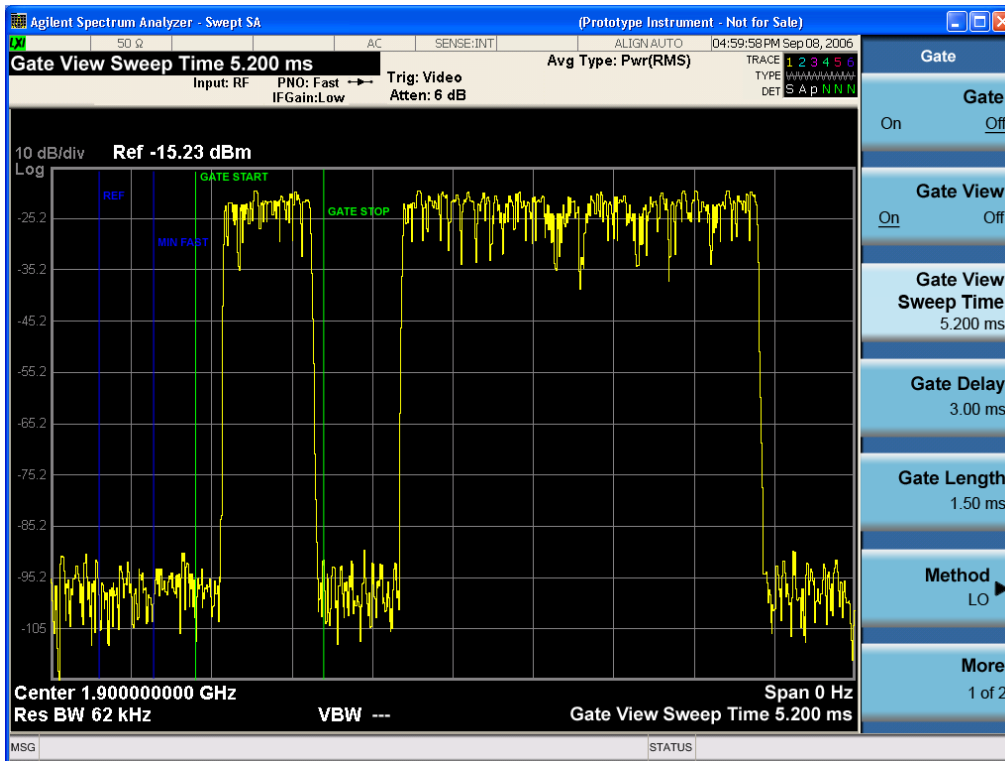

A sample of the Gate View screen in other measurements is shown in the following graphic . This example is for the ACP measurement:

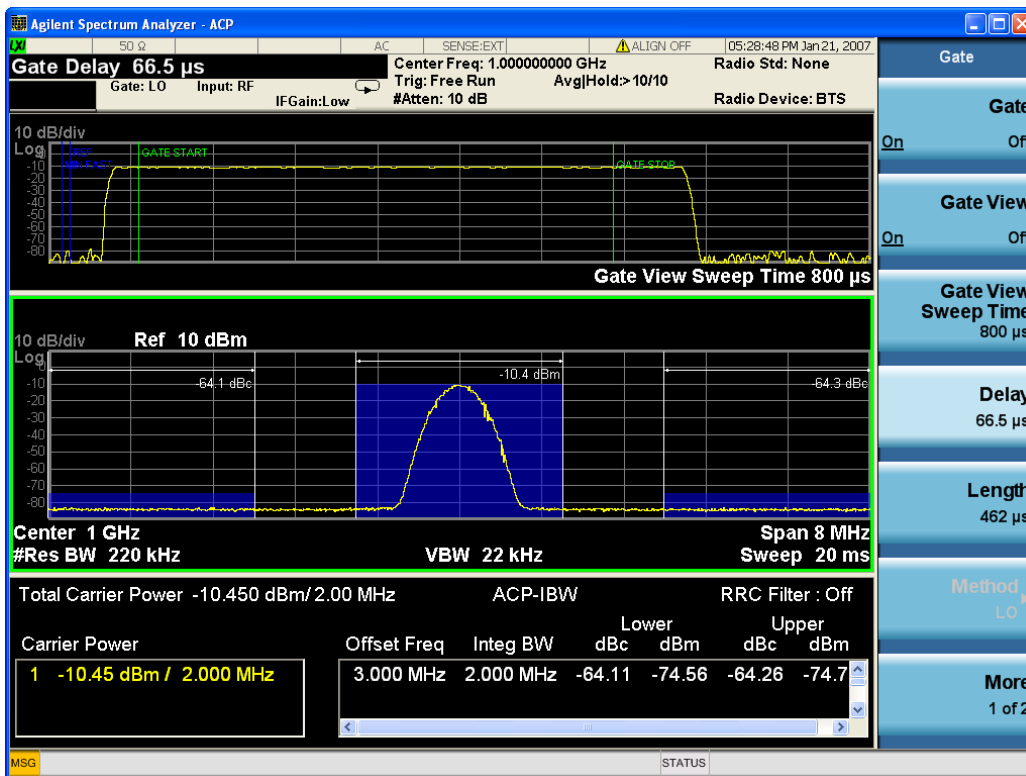

Turning Gate View off returns the analyzer to the Normal measurement view.

In the Swept SA, the normal measurement view is the single-window Swept SA view. When returning to this view, the Swept SA measurement returns to the Span it was in before entering **Gate View** (even if that is Zero Span).

The **Gate View** window is triggered from the Gate Source, with zero trigger delay. Also, when updating the **Gate View** window, the Gate itself must not operate. So it is internally shut off while the gate view window is being updated. For the Swept SA measurement, this means that the Gate is internally shut off whenever the gate view window is displayed. The measurement bar and softkeys continue to show the Trigger source for the main sweep window and give no indication that the Gate is shut off or that the Gate View window is triggered from the Gate Source.

When in **Gate View**, vertical lines are displayed in the Gate View window as follows:

- Green lines are displayed at the gate edges as follows: in Edge Gate, a line is shown for Delay and one for the end of the Gate period, defined by Length. You can adjust the position of the green lines by adjusting the gate length and the gate delay. These lines update in the Gate View window as the active function changes, even if the window is not being updated. In Gated FFT, their location is relative to the left edge of the screen.
- A blue line is displayed showing the delay reference, that is, the reference point for the Gate Delay within the Zero Span window. The blue line represents where (in time) the effective location of the gate start would be if the gate were programmed to zero delay.

- 

## Gate View Setup

Accesses a menu that enables you to setup parameters relevant to the Gate View

Key Path	Sweep/Control, Gate
Scope	Meas Global
Initial S/W Revision	A.10.00

## Gate View Acquisition Time

Controls the acquisition time in the Gate View window. To provide an optimal view of the gate signal, the analyzer initializes Gate View Acq Time based on the current settings of Gate Delay and Gate Length.

Key Path	Sweep/Control, Gate, Gate View Setup
Remote Command	[ :SENSe ] :SWEep:EGATe:TIME <time> [ :SENSe ] :SWEep:EGATe:TIME?
Example	SWE:EGAT:TIME 500 ms
Dependencies	Gate View Acquisition Time is initialized: <ul style="list-style-type: none"> <li>• On Preset (after initializing delay and length).</li> <li>• Every time the Gate Method is set/changed.</li> </ul> <ol style="list-style-type: none"> <li>1. Compute the location of the "gate stop" line, which you know is at time <math>t = t_{min} + GateDelay +</math></li> </ol>



GateLength.	
Preset	519.3 $\mu$ s WiMAX OFDMA: 5 ms GSM/EDGE: 1 ms
State Saved	Saved in instrument state
Min	100 ns
Max	6000 s
Initial S/W Revision	Prior to A.02.00

### Gate View Start Time

Controls the time at the left edge of the Gate View.

Key Path	Sweep/Control, Gate, Gate View Setup
<b>Remote Command</b>	[ :SENSe ] :SWEep:EGATe:VIEW:STARt <time> [ :SENSe ] :SWEep:EGATe:VIEW:STARt?
<b>Example</b>	SWE:EGAT:VIEW:STAR 10ms
Notes	Units of time are required or no units; otherwise an invalid suffix error message will be generated. See error -131.
Preset	0 ms
State Saved	Saved in instrument state
Min	0
Max	500 ms
Initial S/W Revision	A.10.00

### Gate Delay

Controls the length of time from the time the gate condition goes True until the gate is turned on.

Key Path	Sweep/Control, Gate
<b>Remote Command</b>	[ :SENSe ] :SWEep:EGATe:DELAy <time> [ :SENSe ] :SWEep:EGATe:DELAy?
<b>Example</b>	SWE:EGAT:DELAy 500ms SWE:EGAT:DELAy?
Notes	Units of time are required or no units; otherwise an invalid suffix error message will be generated.
Preset	57.7 $\mu$ s WiMAX OFDMA: 71 $\mu$ s GSM/EDGE: 600 $\mu$ s

	WLAN: 500 us WLAN: 36 us
State Saved	Saved in instrument state
Min	0.0 us
Max	100 s
<b>Backwards Compatibility SCPI</b>	[:SENSe]:SWEep:TIME:GATE:DELay ESA compatibility
Initial S/W Revision	Prior to A.02.00

## Gate Length

Controls the length of time that the gate is on after it opens.

Key Path	Sweep/Control, Gate
<b>Remote Command</b>	[:SENSe]:SWEep:EGATe:LENGth <time> [:SENSe]:SWEep:EGATe:LENGth?
<b>Example</b>	SWE:EGAT:LENG 1 SWE:EGAT:LENG?
Notes	Units of time are required or no units; otherwise an invalid suffix error message will be generated.
Preset	461.6 us WiMAX OFDMA: 50 us GSM/EDGE: 200 us WLAN: 1.54 ms WLAN: 32 us
State Saved	Saved in instrument state
Min	100 ns
Max	5 s
<b>Backwards Compatibility SCPI</b>	[:SENSe]:SWEep:TIME:GATE:LENGth ESA compatibility
Initial S/W Revision	Prior to A.02.00

## Gate Source

The menus under the Gate Source key are the same as those under the Trigger key, with the exception that neither Free Run nor Video are available as Gate Source selections. However, a different SCPI command is used to select the Gate Source (see table below) because you may independently set the Gate Source and the Trigger Source.

Any changes to the settings in the setup menus under each Gate Source selection key (for example: Trigger Level, Trigger Delay, etc.) also affect the corresponding settings under the Trigger menu keys. The SCPI commands used for these are the same for Trigger and Gate, since there is only one setting which affects both Gate and Trigger. Example: to set the Trigger Level for External 1 you use the command :TRIG:EXT1:LEV regardless of whether you are using External 1 as a Trigger Source or a Gate Source.

Key Path	Sweep/Control, Gate
Remote Command	[ :SENSe ] :SWEep:EGATe:SOURce EXTernal1   EXTernal2   LINE   FRAME   RFBurst [ :SENSe ] :SWEep:EGATe:SOURce?
Dependencies	In some models, there is no second External input. In these models, the External 2 key is blanked and the EXTernal2 parameter will generate a "Hardware missing; Not available for this model number" error.
Preset	EXTernal 1 GSM/EDGE, MSR: FRAME LTETDD: EXTernal 1When Direction is Downlink, FRAME when Direction is Uplink.
Initial S/W Revision	Prior to A.02.00
Modified at S/W Revision	A.03.00, A.14.00

## Video (IF Envelope)

Pressing this key, when it is not selected, selects the video signal as the trigger. The Video trigger condition is met when the video signal (the filtered and detected version of the input signal, including both RBW and VBW filtering) crosses the video trigger level.

### NOTE

When the detector selected for all active traces is the average detector, the video signal for triggering does not include any VBW filtering.

The video trigger level is shown as a labeled line on the display. The line is displayed as long as video is the selected trigger source.

Pressing this key, when it is already selected, accesses the video trigger setup functions.

Key Path	Trigger
Example	TRIG:SOUR VID          Swept SA measurement TRIG:<meas>:SOUR VID   Measurements other than Swept SA
Notes	Log Plot and Spot Frequency measurements do not support Video Trigger
Dependencies	Video trigger is allowed in average detector mode.
State Saved	Saved in instrument state
Status Bits/OPC dependencies	The Status Operation Register bit 5 "Waiting for Trigger" is set at the same time as the Sweeping or Measuring bit is set. It is cleared when the trigger actually occurs (that is, after the trigger event occurs and all the applicable trigger criteria have been met). A corresponding pop-up message ("Waiting for trigger") is generated if no trigger signal appears after approximately 2 sec. This message goes away when a trigger signal appears.

Backwards Compatibility Notes	In the past, the Average detector was not available when Video triggering was on, and consequently, functions that set the detector to average (such as Marker Noise or Band/Intvl Power) were not available when the video trigger was on. Similarly, Video triggering was not available when the detector was Average. In the X-Series, these restrictions are removed.
Initial S/W Revision	Prior to A.02.00

### Trigger Level

Sets a level for the video signal trigger. When the video signal crosses this level, with the chosen slope, the trigger occurs. This level is displayed with a horizontal line only if **Video** is the selected trigger source.

Key Path	Trigger, Video
Remote Command	:TRIGger[:SEquence]:VIDeo:LEVel <ampl> :TRIGger[:SEquence]:VIDeo:LEVel?
Example	TRIG:VID:LEV -40 dBm
Notes	<p>When sweep type = FFT, the video trigger uses the amplitude envelope in a bandwidth wider than the FFT width as a trigger source. This might often be useful, but does not have the same relationship between the displayed trace and the trigger level as in swept triggering.</p> <p>Amplitude Corrections are not taken into account by the Video Trig Level. For example, if you have given yourself effective gain with an amplitude correction factor, the Video Trigger will not fire until you have dropped the trigger line that far below the displayed signal level, rather than simply dropping it down to the displayed signal level.</p> <p>Note that other corrections, specifically External Gain and Ref Level Offset, modify the actual trace data as it is taken and therefore ARE taken into account by Trig Level.</p>
Couplings	This same level is used for the Video trigger source in the Trigger menu and for the Video selection in the Gate Source menu.
Preset	Set the Video Trigger Level -25 dBm on Preset. When the Video Trigger Level becomes the active function, if the value is off screen, set it to either the top or bottom of screen, depending on which direction off screen it was.
State Saved	Saved in instrument state
Min	-170 dBm
Max	+30 dBm
Default Unit	Depends on the current selected Y axis unit
Backwards Compatibility SCPI	:TRIGger[:SEquence]:IF:LEVel :TRIGger[:SEquence]:IF:LEVel?
Backwards Compatibility Notes	This alias is provided for backward compatibility with VSA/PSA comms apps.
Initial S/W Revision	Prior to A.02.00

## Trig Slope

Controls the trigger polarity. It is set positive to trigger on a rising edge and negative to trigger on a falling edge.

Key Path	Trigger, Video
<b>Remote Command</b>	:TRIGger[:SEquence]:VIDeo:SLOPe POSitive NEGative :TRIGger[:SEquence]:VIDeo:SLOPe?
<b>Example</b>	TRIG:VID:SLOP NEG
Preset	POSitive
State Saved	Saved in instrument state
<b>Backwards Compatibility SCPI</b>	:TRIGger[:SEquence]:IF:SLOPe NEGative POSitive :TRIGger[:SEquence]:IF:SLOPe? For backward compatibility with VSA/PSA comms apps
Backwards Compatibility Notes	The legacy :TRIGger[:SEquence]:SLOPe command affects the slopes for the VID, LINE, EXT1, EXT2, and RFB triggers.
Initial S/W Revision	Prior to A.02.00

<b>Remote Command</b>	:TRIGger[:SEquence]:SLOPe POSitive NEGative :TRIGger[:SEquence]:SLOPe?
<b>Example</b>	TRIG:SLOP NEG
Preset	POSitive
State Saved	Saved in instrument state
Backwards Compatibility Notes	In ESA/PSA, the Trigger Slope was global to all triggers. In the X-Series, the slope can be set individually for each Trigger Source. For backward compatibility, the global SLOPe command updates all instances of trigger slope (VID, LINE, EXT1, EXT2, TV, RFB). The query returns the trigger slope setting of the currently selected trigger source.
Initial S/W Revision	Prior to A.02.00

## External 1

Pressing this key, when it is not selected, selects an external input signal as the trigger. A new sweep/measurement will start when the external trigger condition is met using the external 1 input connector on the rear panel.

Pressing this key, when it is already selected, accesses the external 1 trigger setup menu.

Key Path	Trigger
<b>Example</b>	TRIG:SOUR EXT1 Swept SA measurement TRIG:<meas>:SOUR EXT1 Measurements other than Swept SA
Dependencies	Grayed out if in use by Point Trigger in the Source Setup menu. Forced to Free Run if already selected and Point Trigger is set to External 1.

State Saved	Saved in instrument state
Status Bits/OPC dependencies	The Status Operation Register bit 5 "Waiting for Trigger" is set at the same time as the Sweeping or Measuring bit is set. It is cleared when the trigger actually occurs (that is, after the trigger event occurs and all the applicable trigger criteria have been met). A corresponding pop-up message ("Waiting for trigger") is generated if no trigger signal appears after approximately 2 sec. This message goes away when a trigger signal appears.
Initial S/W Revision	Prior to A.02.00

### Trigger Level

Sets the value where the external 1 trigger input will trigger a new sweep/measurement.

Key Path	Trigger, External 1
<b>Remote Command</b>	:TRIGger[:SEquence]:EXTernal1:LEVel <level> :TRIGger[:SEquence]:EXTernal1:LEVel?
<b>Example</b>	TRIG:EXT1:LEV 0.4 V
Couplings	This same level is used for the Ext1 trigger source in the Trigger menu, for the Ext1 selection in the Periodic Timer sync source (in the Trigger menu and in the Gate Source menu), and also for the Ext1 selection in the Gate Source menu.
Preset	1.2 V
State Saved	Saved in instrument state
Min	-3.5V
Max	3.5V
Default Unit	V
<b>Backwards Compatibility SCPI</b>	:TRIGger[:SEquence]:EXTernal:LEVel For backward compatibility, the parameter EXTernal is mapped to EXTernal1
<b>Backwards Compatibility SCPI</b>	:TRIGger[:SEquence]:FRAMe:EXTernal1:LEVel
Initial S/W Revision	Prior to A.02.00

### Trig Slope

Controls the trigger polarity. It is set positive to trigger on a rising edge and negative to trigger on a falling edge.

Key Path	Trigger, External 1
<b>Remote Command</b>	:TRIGger[:SEquence]:EXTernal1:SLOPe POSitive NEGative :TRIGger[:SEquence]:EXTernal1:SLOPe?

<b>Example</b>	TRIG:EXT1:SLOP NEG
Couplings	This same slope is used in the Ext1 selection for the trigger source in the Trigger menu and for the period timer sync source (in the Trigger menu and in the Gate Source menu).
Preset	POSitive
State Saved	Saved in instrument state
<b>Backwards Compatibility SCPI</b>	:TRIGger[:SEQuence]:EXTernal:SLOPe For backward compatibility, the parameter EXTernal is mapped to EXTernal1
<b>Backwards Compatibility SCPI</b>	:TRIGger[:SEQuence]:FRAMe:EXTernal1:SLOPe
Backwards Compatibility Notes	The legacy :TRIGger[:SEQuence]:SLOPe command affects the slopes for the VID, LINE, EXT1, EXT2, and RFB triggers.
Initial S/W Revision	Prior to A.02.00

### Zero Span Delay Comp On/Off

In zero span, there is a natural delay in the signal path, which comes from the RBW filter. This is usually desirable, as it allows you to trigger on events and also see those events, because the signal is delayed from the trigger event. However, in some cases it is desirable to eliminate this delay, so that trigger events line up exactly with the zero time point in zero span. You can use the Zero Span Delay Comp On/Off feature to enable or disable zero span delay compensation.

Key Path	Trigger, External 1
<b>Remote Command</b>	:TRIGger[:SEQuence]:EXTernal1:DELAy:COMPensation OFF ON 0 1 :TRIGger[:SEQuence]:EXTernal1:DELAy:COMPensation?
<b>Example</b>	TRIG:EXT1:DEL:COMP ON
Dependencies	No effect except in zero-span, but not locked out in nonzero spans. Blanked in modes that do not support zero-span measurements. If the SCPI command is sent when the key is blanked, an error is returned: -221, "Settings conflict; Feature not supported for this measurement" In analyzers shipping N9060A, this feature requires N9060A-7FP.
Preset	OFF
State Saved	Saved in instrument state
Initial S/W Revision	A.11.00

### External 2

Pressing this key, when it is not selected, selects an external input signal as the trigger. A new sweep/measurement will start when the external trigger condition is met using the external 2 input connector. The external trigger 2 input connector is on the rear panel.

Pressing this key, when it is already selected, accesses the external 2 trigger setup menu.

Key Path	Trigger
<b>Example</b>	TRIG:SOUR EXT2 Swept SA measurement TRIG:<meas>:SOUR EXT2 Measurements other than Swept SA
Dependencies	In some models, there is no second External input. In these models, the External 2 key is blanked and the EXTERNAL2 parameter will generate a "Hardware missing; Not available for this model number" message. Grayed out if in use by Point Trigger in the Source Setup menu. Forced to Free Run if already selected and Point Trigger is set to External 2.
State Saved	Saved in instrument state
Status Bits/OPC dependencies	The Status Operation Register bit 5 "Waiting for Trigger" is set at the same time as the Sweeping or Measuring bit is set. It is cleared when the trigger actually occurs (that is, after the trigger event occurs and all the applicable trigger criteria have been met). A corresponding pop-up message ("Waiting for trigger") is generated if no trigger signal appears after approximately 2 sec. This message goes away when a trigger signal appears.
Initial S/W Revision	Prior to A.02.00
Modified at S/W Revision	A.03.00

### Trigger Level

Sets the value where the external 2 trigger input will trigger a new sweep/measurement.

Key Path	Trigger, External 2
<b>Remote Command</b>	:TRIGger[:SEquence]:EXTernal2:LEVel :TRIGger[:SEquence]:EXTernal2:LEVel?
<b>Example</b>	TRIG:EXT2:LEV 1.1 V
Couplings	This same level is used for the Ext2 trigger source in the Trigger menu, for the Ext2 selection in the Periodic Timer sync source (in the Trigger menu and in the Gate Source menu), and also for the Ext2 selection in the Gate Source menu.
Preset	1.2 V
State Saved	Saved in instrument state
Min	-3.5V
Max	3.5V
Default Unit	V
<b>Backwards Compatibility SCPI</b>	:TRIGger[:SEquence]:FRAME:EXTernal2:LEVel
Initial S/W Revision	Prior to A.02.00



## Trig Slope

Controls the trigger polarity. It is set positive to trigger on a rising edge and negative to trigger on a falling edge.

Key Path	Trigger, External 2
<b>Remote Command</b>	:TRIGger[:SEquence]:EXTernal2:SLOPe POSitive NEGative :TRIGger[:SEquence]:EXTernal2:SLOPe?
<b>Example</b>	TRIG:EXT2:SLOP NEG
Couplings	This same slope is used in the Ext2 selection for the trigger source in the Trigger menu and for the period timer sync source (in the Trigger menu and in the Gate Source menu).
Preset	POSitive
State Saved	Saved in instrument state
<b>Backwards Compatibility SCPI</b>	:TRIGger[:SEquence]:FRAMe:EXTernal2:SLOPe
Backwards Compatibility Notes	The legacy :TRIGger[:SEquence]:SLOPe command affects the slopes for the VID, LINE, EXT1, EXT2, and RFB triggers.
Initial S/W Revision	Prior to A.02.00

## Zero Span Delay Comp On/Off

In zero span, there is a natural delay in the signal path, which comes from the RBW filter. This is usually desirable, as it allows you to trigger on events and also see those events, because the signal is delayed from the trigger event. However, in some cases it is desirable to eliminate this delay, so that trigger events line up exactly with the zero time point in zero span. You can use the Zero Span Delay Comp On/Off feature to enable or disable zero span delay compensation.

Key Path	Trigger, External 2
<b>Remote Command</b>	:TRIGger[:SEquence]:EXTernal2:DELAy:COMPensation OFF ON 0 1 :TRIGger[:SEquence]:EXTernal2:DELAy:COMPensation?
<b>Example</b>	TRIG:EXT2:DEL:COMP ON
Dependencies	No effect except in zero-span, but not locked out in nonzero spans. Blanked in modes that do not support zero-span measurements. If the SCPI command is sent when the key is blanked, an error is returned: -221, "Settings conflict; Feature not supported for this measurement" In analyzers shipping N9060A, this feature requires N9060A-7FP.
Preset	OFF
State Saved	Saved in instrument state
Initial S/W Revision	A.11.00

## RF Burst

Pressing this key, when it is not selected, selects the RF Burst as the trigger. A new sweep/measurement will start when an RF burst envelope signal is identified from the signal at the RF Input connector. Pressing this key, when it is already selected, accesses the RF Burst trigger setup menu.

In some models, a variety of burst trigger circuitry is available, resulting in various available burst trigger bandwidths. The analyzer automatically chooses the appropriate trigger path based on the hardware configuration and other settings of the analyzer.

Key Path	Trigger
<b>Example</b>	TRIG:SOUR RFB Swept SA measurement TRIG:< meas>:SOUR RFB Measurements other than Swept SA
State Saved	Saved in instrument state
Status Bits/OPC dependencies	The Status Operation Register bit 5 "Waiting for Trigger" is set at the same time as the Sweeping or Measuring bit is set. It is cleared when the trigger actually occurs (that is, after the trigger event occurs and all the applicable trigger criteria have been met). A corresponding pop-up message ("Waiting for trigger") is generated if no trigger signal appears after approximately 2 sec. This message goes away when a trigger signal appears.
Backwards Compatibility Notes	The legacy command: :TRIGger[:SEQuence]:RFBurst:FSElectivity[:STATe] OFF ON 0 1 is not supported in the X-Series, as the hardware to do Frequency Selective burst triggers does not exist in X-Series.
Initial S/W Revision	Prior to A.02.00
Modified at S/W Revision	A.04.00

## Absolute Trigger Level

Sets the absolute trigger level for the RF burst envelope.

When using the External Mixing path, the Absolute Trigger Level is uncalibrated because the factory default was set to accommodate the expected IF levels for the RF path.

Key Path	Trigger, RF Burst
Scope	Meas Global
<b>Remote Command</b>	:TRIGger[:SEQuence]:RFBurst:LEVel:ABSolute <ampl> :TRIGger[:SEQuence]:RFBurst:LEVel:ABSolute?
<b>Example</b>	TRIG:RFB:LEV:ABS 10 dBm sets the trigger level of the RF burst envelope signal to the absolute level of 10 dBm
Notes	Sending this command does not switch the setting from relative to absolute; to switch it you need to send the :TRIGger[:SEQuence]:RFBurst:LEVel:TYPE command, below. Amplitude Corrections are not taken into account by the Absolute Trigger Level. For example, if you have given yourself effective gain with an amplitude correction factor, the Absolute Trigger will not fire until you have set the trigger level that far below the displayed signal level, rather than simply to

	the displayed signal level. This is only true for Amplitude Corrections, not External Gain or Ref Level Offset functions. If mode is Bluetooth, the default value is -50 dBm.
Couplings	This same level is used for the RF Burst trigger source in the Trigger menu, for the RF Burst selection in the Periodic Timer sync source (in the Trigger menu and in the Gate Source menu), and also for the RF Burst selection in the Gate Source menu
Preset	-20 dBm
State Saved	Saved in instrument state
Min	-200 dBm
Max	100 dBm
Default Unit	depends on the current selected Y-Axis unit
<b>Backwards Compatibility SCPI</b>	:TRIGger[:SEquence]:FRAMe:RFBurst:LEVel:ABSolute
Initial S/W Revision	Prior to A.02.00
Modified at S/W Revision	A.04.00

Key Path	Trigger, RF Burst
<b>Remote Command</b>	:TRIGger[:SEquence]:RFBurst:LEVel:TYPE ABSolute RELative :TRIGger[:SEquence]:RFBurst:LEVel:TYPE?
<b>Example</b>	TRIG:RFB:LEV:TYPE REL sets the trigger level type of the RF burst trigger to Relative.
Preset	ABSolute
State Saved	Saved in instrument state
Initial S/W Revision	Prior to A.02.00
Modified at S/W Revision	A.04.00

### Relative Trigger Level

Sets the relative trigger level for the RF burst envelope.

In some models, the relative burst trigger function is implemented in hardware. In other models, without the advanced triggering hardware required, the relative burst trigger function is implemented in software in some measurements, and is unavailable in other measurements.

When implemented in software, the relative RF Burst trigger function is implemented as follows:

1. The measurement starts with the absolute RF Burst trigger setting. If it cannot get a trigger with that level, auto trigger fires and the acquisition starts anyway. After the acquisition, the measurement searches for the peak in the acquired waveform and saves it.

2. Now, in the next cycle of the measurement, the measurement determines a new absolute RF Burst level based on the peak value from the first measurement and the Relative RF Burst Trigger Level (always 0 or negative dB) set by the user. The following formula is used:
3. absolute RF Burst level = peak level of the previous acquisition + relative RF Burst level
4. If the new absolute RF Burst level differs from the previous by more than 0.5 dB, the new level is sent to the hardware; otherwise it is not updated (to avoid slowing down the acquisition)

Steps 2 and 3 repeat for subsequent measurements.

Key Path	Trigger, RF Burst
Scope	Meas Global
<b>Remote Command</b>	:TRIGger[:SEquence]:RFBurst:LEVel:RELative <rel_ampl> :TRIGger[:SEquence]:RFBurst:LEVel:RELative?
<b>Example</b>	TRIG:RFB:LEV:REL -10 dB sets the trigger level of the RF burst envelope signal to the relative level of -10 dB
Notes	Sending this command does not switch the setting from absolute to relative; to switch it you need to send the :TRIGger[:SEquence]:RFBurst:LEVel:TYPE command, above. The relative trigger level is not available in some measurements. In those measurements the RELative parameter, and the :TRIGger[:SEquence]:RFBurst:LEVel:TYPE command (above), will generate an error if sent.
Dependencies	This key is grayed out and Absolute Trigger Level selected if the required hardware is not present in your analyzer and the current measurement does not support Relative triggering.
Preset	-6 dB GSM: -25 dB
State Saved	Saved in instrument state
Min	-45 dB
Max	0 dB
Default Unit	dB or dBc
<b>Backwards Compatibility SCPI</b>	:TRIGger[:SEquence]:RFBurst:LEVel This legacy command is aliased to :TRIGger[:SEquence]:RFBurst:LEVel:RELative because the PSA had ONLY relative burst triggering
Initial S/W Revision	Prior to A.02.00
Modified at S/W Revision	A.04.00

### Trigger Slope

It is set positive to trigger on a rising edge and negative to trigger on a falling edge.

Key Path	Trigger, RF Burst
<b>Remote Command</b>	:TRIGger[:SEquence]:RFBurst:SLOPe POSitive NEGative :TRIGger[:SEquence]:RFBurst:SLOPe?

<b>Example</b>	TRIG:RFB:SLOP NEG
Couplings	This same slope is used in the RF Burst selection for the trigger source in the Trigger menu and for the period timer sync source (in the Trigger menu and in the Gate Source menu).
Preset	POSitive
State Saved	Saved in instrument state
<b>Backwards Compatibility SCPI</b>	:TRIGger[:SEQuence]:FRAMe:RFBurst:SLOPe
Backwards Compatibility Notes	The legacy :TRIGger[:SEQuence]:SLOPe command affects the slopes for the VID, LINE, EXT1, EXT2, and RFB triggers.
Initial S/W Revision	Prior to A.02.00

### Periodic Timer (Frame Trigger)

Pressing this key, when it is not selected, selects the internal periodic timer signal as the trigger. Triggering occurrences are set by the **Period** parameter, which is modified by the **Sync Source** and **Offset**. Pressing this key, when it is already selected, accesses the periodic timer trigger setup functions.

If you do not have a sync source selected (it is Off), then the internal timer will not be synchronized with any external timing events.

Key Path	Trigger
<b>Example</b>	TRIG:SOUR FRAM                      Swept SA measurement TRIG:<meas>:SOUR FRAM      Measurements other than Swept SA
State Saved	Saved in instrument state
Readback	[Sync: <value of Sync Source>], for example, [Sync: External 1]
Status Bits/OPC dependencies	The Status Operation Register bit 5 "Waiting for Trigger" is set at the same time as the Sweeping or Measuring bit is set. It is cleared when the trigger actually occurs (that is, after the trigger event occurs and all the applicable trigger criteria have been met). A corresponding pop-up message ("Waiting for trigger") is generated if no trigger signal appears after approximately 2 sec. This message goes away when a trigger signal appears.
Initial S/W Revision	Prior to A.02.00

### Periodic Timer Triggering:

This feature selects the internal periodic timer signal as the trigger. Trigger occurrences are set by the **Periodic Timer** parameter, which is modified by the **Sync Source** and **Offset**.

The figure below shows the action of the periodic timer trigger. Before reviewing the figure, we'll explain some uses for the periodic trigger.

A common application is measuring periodic burst RF signals for which a trigger signal is not easily available. For example, we might be measuring a TDMA radio which bursts every 20 ms. Let's assume that the 20 ms period is very consistent. Let's also assume that we do not have an external trigger source

available that is synchronized with the period, and that the signal-to-noise ratio of the signal is not high enough to provide a clean RF burst trigger at all of the analysis frequencies. For example, we might want to measure spurious transmissions at an offset from the carrier that is larger than the bandwidth of the RF burst trigger. In this application, we can set the Periodic Timer to a 20.00 ms period and adjust the offset from that timer to position our trigger just where we want it. If we find that the 20.00 ms is not exactly right, we can adjust the period slightly to minimize the drift between the period timer and the signal to be measured.

A second way to use this feature would be to use **Sync Source** temporarily, instead of **Offset**. In this case, we might tune to the signal in a narrow span and use the RF Burst trigger to synchronize the periodic timer. Then we would turn the sync source off so that it would not miss-trigger. Miss-triggering can occur when we are tuned so far away from the RF burst trigger that it is no longer reliable.

A third example would be to synchronize to a signal that has a reference time element of much longer period than the period of interest. In some CDMA applications, it is useful to look at signals with a short periodicity, by synchronizing that periodicity to the "even-second clock" edge that happens every two seconds. Thus, we could connect the even-second clock trigger to Ext1 and use then Ext1 as the sync source for the periodic timer.

The figure below illustrates this third example. The top trace represents the even-second clock. It causes the periodic timer to synchronize with the leading edge shown. The analyzer trigger occurs at a time delayed by the accumulated offset from the period trigger event. The periodic timer continues to run, and triggers continue to occur, with a periodicity determined by the analyzer time base. The timer output (labeled "late event") will drift away from its ideal time due to imperfect matching between the time base of the signal being measured and the time base of the analyzer, and also because of imperfect setting of the period parameter. But the synchronization is restored on the next even-second clock event. ("Accumulated offset" is described in the in the **Offset** function section.)

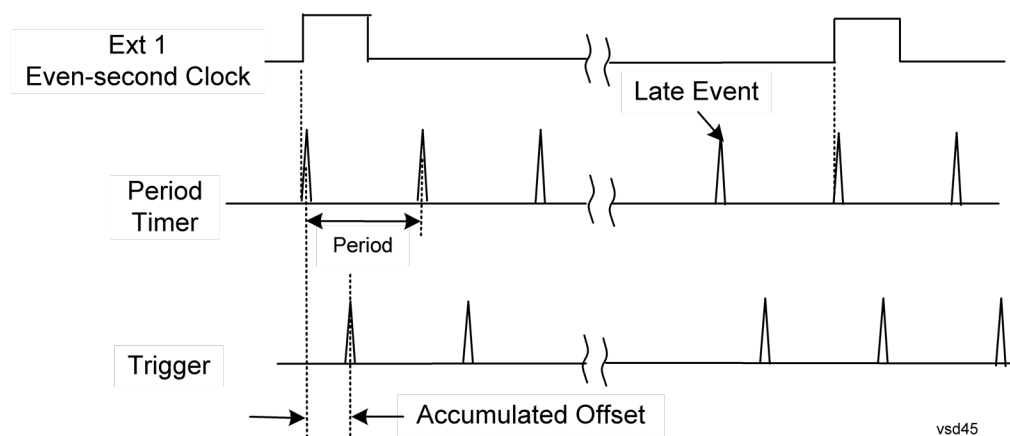

### Period

Sets the period of the internal periodic timer clock. For digital communications signals, this is usually set to the frame period of your current input signal. In the case that sync source is not set to OFF, and the external sync source rate is changed for some reason, the periodic timer is synchronized at the every external synchronization pulse by resetting the internal state of the timer circuit.

<b>Key Path</b>	Trigger, Periodic Timer
<b>Remote Command</b>	:TRIGger[:SEquence]:FRAME:PERiod <time>

	:TRIGger[:SEquence]:FRAMe:PERiod?
<b>Example</b>	TRIG:FRAM:PER 100 ms
Dependencies	The invalid data indicator turns on when the period is changed, until the next sweep/measurement completes.
Couplings	The same period is used in the Gate Source selection of the period timer.
Preset	20 ms GSM: 4.615383
State Saved	Saved in instrument state
Min	100.000 ns
Max	559.0000 ms
Default Unit	S
Initial S/W Revision	Prior to A.02.00

### Offset

Adjusts the accumulated offset between the periodic timer events and the trigger event. Adjusting the accumulated offset is different than setting an offset, and requires explanation.

The periodic timer is usually not synchronized with any external events, so the timing of its output events has no absolute meaning. Since the timing relative to external events (RF signals) is important, you need to be able to adjust (offset) it. However, you have no direct way to see when the periodic timer events occur. All that you can see is the trigger timing. When you want to adjust the trigger timing, you will be changing the internal offset between the periodic timer events and the trigger event. Because the absolute value of that internal offset is unknown, we will just call that the accumulated offset. Whenever the Offset parameter is changed, you are changing that accumulated offset. You can reset the displayed offset using Reset Offset Display. Changing the display does not change the value of the accumulated offset, and you can still make additional changes to accumulated offset.

To avoid ambiguity, we define that an increase in the "offset" parameter, either from the knob or the SCPI adjust command, serves to delay the timing of the trigger event.

Key Path	Trigger, Periodic Timer
<b>Remote Command</b>	:TRIGger[:SEquence]:FRAMe:OFFSet <time> :TRIGger[:SEquence]:FRAMe:OFFSet?
<b>Example</b>	TRIG:FRAM:OFFS 1.2 ms
Notes	The front panel interface (for example, the knob), and this command, adjust the accumulated offset, which is shown on the active function display. However, the actual amount sent to the hardware each time the offset is updated is the delta value, that is, the current accumulated offset value minus the previous accumulated offset value. Note that the accumulated offset value is essentially arbitrary; it represents the accumulated offset from the last time the offset was zeroed (with the Reset Offset Display key).  Note that this command does not change the period of the trigger waveform. Note also that Offset is used only when the sync source is set to OFF, otherwise delay is used, see section "Trig Delay" on page 275.

	An increase in the "offset" parameter, either from the knob or the SCPI adjust command, serves to delay the timing of the trigger event.
Notes	When the SCPI command is sent the value shown on the key (and the Active Function, if this happens to be the active function) is updated with the new value. However, the actual amount sent to the hardware is the delta value, that is, the current accumulated offset value minus the previous accumulated offset value.  The SCPI query simply returns the value currently showing on the key.
Dependencies	The invalid data indicator turns on when the offset is changed, until the next sweep/measurement completes.
Couplings	The same offset is used in the Gate Source selection of the period timer.
Preset	0 s
State Saved	Saved in instrument state
Min	-10.000 s
Max	10.000 s
Default Unit	S
Initial S/W Revision	Prior to A.02.00

#### Offset Adjust (Remote Command Only)

This remote command does not work at all like the related front panel keys. This command lets you advance the phase of the frame trigger by the amount you specify.

It does not change the period of the trigger waveform. If the command is sent multiple times, it advances the phase of the frame trigger an additional amount each time it is sent. Negative numbers are permitted.

<b>Remote Command</b>	:TRIGger[:SEquence]:FRAMe:ADJust <time>
<b>Example</b>	TRIG:FRAM:ADJ 1.2 ms
Notes	Note also that Offset is used only when the sync source is set to OFF, otherwise delay is used, see section <a href="#">"Trig Delay" on page 275</a>  An increase in the "offset" parameter, either from the knob or the SCPI adjust command, serves to delay the timing of the trigger event.
Notes	The front panel interface (for example, the knob) and the :TRIG:FRAM:OFFS command adjust the accumulated offset, which is shown on the active function display. However, the actual amount sent to the hardware is the delta value, that is, the current offset value minus the previous offset value.  When the SCPI command is sent the value shown on the key (and the Active Function, if this happens to be the active function) is updated by increasing it (or decreasing it if the value sent is negative) by the amount specified in the SCPI command.  This is a "command only" SCPI command, with no query.
Dependencies	The invalid data indicator turns on when the offset is changed, until the next sweep/measurement completes.
Couplings	The same offset is used in the Gate Source selection of the period timer.
Preset	0 s



State Saved	Saved in instrument state
Min	-10.000 s
Max	10.000 s
Default Unit	S
Initial S/W Revision	Prior to A.02.00

### Reset Offset Display

Resets the value of the periodic trigger offset display setting to 0.0 seconds. The current displayed trigger location may include an offset value defined with the Offset key. Pressing this key redefines the currently displayed trigger location as the new trigger point that is 0.0 s offset. The Offset key can then be used to add offset relative to this new timing.

Key Path	Trigger, Periodic Timer
<b>Remote Command</b>	:TRIGger[:SEquence]:FRAMe:OFFSet:DISPlay:RESet
<b>Example</b>	TRIG:FRAM:OFFS:DISP:RES
Initial S/W Revision	Prior to A.02.00

### Sync Source

Selects a signal source for you to synchronize your periodic timer trigger to, otherwise you are triggering at some arbitrary location in the frame. Synchronization reduces the precision requirements on the setting of the period.

For convenience you may adjust the level and slope of the selected sync source in a conditional branch setup menu accessed from the Sync Source menu. Note that these settings match those in the **Trigger** and **Gate Source** menus; that is, each trigger source has only one value of level and slope, regardless of which menu it is accessed from.

Key Path	Trigger, Periodic Timer
<b>Remote Command</b>	:TRIGger[:SEquence]:FRAMe:SYNC EXTernal1   EXTernal2   RFBurst   OFF :TRIGger[:SEquence]:FRAMe:SYNC?
<b>Example</b>	TRIG:FRAM:SYNC EXT2
Dependencies	In some models, there is no second External input. In these models, the External 2 key is blanked and the EXTernal2 parameter will generate a "Hardware missing; Not available for this model number" message.
Preset	Off GSM/EDGE, MSR,LTE,LTETDD: RFBurst
State Saved	Saved in instrument state
Readback	The current setting is read back to this key and it is also Readback to the previous Periodic Timer trigger key.

<b>Backwards Compatibility SCPI</b>	:TRIGger[:SEquence]:FRAMe:SYNC EXTernal
Initial S/W Revision	Prior to A.02.00
Modified at S/W Revision	A.03.00, A.14.00

### Off

Turns off the sync source for your periodic trigger. With the sync source off, the timing will drift unless the signal source frequency is locked to the analyzer frequency reference.

<b>Key Path</b>	Trigger, Periodic Timer, Sync Source
<b>Example</b>	TRIG:FRAM:SYNC OFF
Readback	Off
Initial S/W Revision	Prior to A.02.00

### External 1

Pressing this key, when it is not selected, selects an external input signal as the trigger. A new sweep/measurement will start when the external trigger condition is met using the external 1 input connector on the rear panel.

Pressing this key, when it is already selected, accesses the external 1 trigger setup menu.

<b>Key Path</b>	Trigger
<b>Example</b>	TRIG:SOUR EXT1 Swept SA measurement TRIG:<meas>:SOUR EXT1 Measurements other than Swept SA
<b>Dependencies</b>	Grayed out if in use by Point Trigger in the Source Setup menu. Forced to Free Run if already selected and Point Trigger is set to External 1.
<b>State Saved</b>	Saved in instrument state
<b>Status Bits/OPC dependencies</b>	The Status Operation Register bit 5 "Waiting for Trigger" is set at the same time as the Sweeping or Measuring bit is set. It is cleared when the trigger actually occurs (that is, after the trigger event occurs and all the applicable trigger criteria have been met). A corresponding pop-up message ("Waiting for trigger") is generated if no trigger signal appears after approximately 2 sec. This message goes away when a trigger signal appears.
Initial S/W Revision	Prior to A.02.00

### Trigger Level

Sets the value where the external 1 trigger input will trigger a new sweep/measurement.

Key Path	Trigger, External 1
<b>Remote Command</b>	:TRIGger[:SEQuence]:EXTernal1:LEVel <level> :TRIGger[:SEQuence]:EXTernal1:LEVel?
<b>Example</b>	TRIG:EXT1:LEV 0.4 V
Couplings	This same level is used for the Ext1 trigger source in the Trigger menu, for the Ext1 selection in the Periodic Timer sync source (in the Trigger menu and in the Gate Source menu), and also for the Ext1 selection in the Gate Source menu.
Preset	1.2 V
State Saved	Saved in instrument state
Min	-3.5V
Max	3.5V
Default Unit	V
<b>Backwards Compatibility SCPI</b>	:TRIGger[:SEQuence]:EXTernal:LEVel For backward compatibility, the parameter EXTernal is mapped to EXTernal1
<b>Backwards Compatibility SCPI</b>	:TRIGger[:SEQuence]:FRAMe:EXTernal1:LEVel
Initial S/W Revision	Prior to A.02.00

### Trig Slope

Controls the trigger polarity. It is set positive to trigger on a rising edge and negative to trigger on a falling edge.

Key Path	Trigger, External 1
<b>Remote Command</b>	:TRIGger[:SEQuence]:EXTernal1:SLOPe POSitive NEGative :TRIGger[:SEQuence]:EXTernal1:SLOPe?
<b>Example</b>	TRIG:EXT1:SLOP NEG
Couplings	This same slope is used in the Ext1 selection for the trigger source in the Trigger menu and for the period timer sync source (in the Trigger menu and in the Gate Source menu).
Preset	POSitive
State Saved	Saved in instrument state
<b>Backwards Compatibility SCPI</b>	:TRIGger[:SEQuence]:EXTernal:SLOPe For backward compatibility, the parameter EXTernal is mapped to EXTernal1
<b>Backwards Compatibility SCPI</b>	:TRIGger[:SEQuence]:FRAMe:EXTernal1:SLOPe
Backwards Compatibility Notes	The legacy :TRIGger[:SEQuence]:SLOPe command affects the slopes for the VID, LINE, EXT1, EXT2, and RFB triggers.
Initial S/W Revision	Prior to A.02.00

## External 2

Pressing this key, when it is not selected, selects an external input signal as the trigger. A new sweep/measurement will start when the external trigger condition is met using the external 2 input connector. The external trigger 2 input connector is on the rear panel.

Pressing this key, when it is already selected, accesses the external 2 trigger setup menu.

Key Path	Trigger
<b>Example</b>	TRIG:SOUR EXT2 Swept SA measurement TRIG:<meas>:SOUR EXT2 Measurements other than Swept SA
Dependencies	In some models, there is no second External input. In these models, the External 2 key is blanked and the EXTernal2 parameter will generate a "Hardware missing; Not available for this model number" message. Grayed out if in use by Point Trigger in the Source Setup menu. Forced to Free Run if already selected and Point Trigger is set to External 2.
State Saved	Saved in instrument state
Status Bits/OPC dependencies	The Status Operation Register bit 5 "Waiting for Trigger" is set at the same time as the Sweeping or Measuring bit is set. It is cleared when the trigger actually occurs (that is, after the trigger event occurs and all the applicable trigger criteria have been met). A corresponding pop-up message ("Waiting for trigger") is generated if no trigger signal appears after approximately 2 sec. This message goes away when a trigger signal appears.
Initial S/W Revision	Prior to A.02.00
Modified at S/W Revision	A.03.00

## Trigger Level

Sets the value where the external 2 trigger input will trigger a new sweep/measurement.

Key Path	Trigger, External 2
<b>Remote Command</b>	:TRIGger[:SEquence]:EXTernal2:LEVel :TRIGger[:SEquence]:EXTernal2:LEVel?
<b>Example</b>	TRIG:EXT2:LEV 1.1 V
Couplings	This same level is used for the Ext2 trigger source in the Trigger menu, for the Ext2 selection in the Periodic Timer sync source (in the Trigger menu and in the Gate Source menu), and also for the Ext2 selection in the Gate Source menu.
Preset	1.2 V
State Saved	Saved in instrument state
Min	-3.5V
Max	

	3.5V
Default Unit	V
<b>Backwards Compatibility SCPI</b>	:TRIGger[:SEquence]:FRAMe:EXTernal2:LEVel
Initial S/W Revision	Prior to A.02.00

### Trig Slope

Controls the trigger polarity. It is set positive to trigger on a rising edge and negative to trigger on a falling edge.

Key Path	Trigger, External 2
<b>Remote Command</b>	:TRIGger[:SEquence]:EXTernal2:SLOPe POSitive NEGative :TRIGger[:SEquence]:EXTernal2:SLOPe?
<b>Example</b>	TRIG:EXT2:SLOP NEG
Couplings	This same slope is used in the Ext2 selection for the trigger source in the Trigger menu and for the period timer sync source (in the Trigger menu and in the Gate Source menu).
Preset	POSitive
State Saved	Saved in instrument state
<b>Backwards Compatibility SCPI</b>	:TRIGger[:SEquence]:FRAMe:EXTernal2:SLOPe
Backwards Compatibility Notes	The legacy :TRIGger[:SEquence]:SLOPe command affects the slopes for the VID, LINE, EXT1, EXT2, and RFB triggers.
Initial S/W Revision	Prior to A.02.00

### RF Burst

Pressing this key, when it is not selected, selects the RF Burst as the trigger. A new sweep/measurement will start when an RF burst envelope signal is identified from the signal at the RF Input connector. Pressing this key, when it is already selected, accesses the RF Burst trigger setup menu.

In some models, a variety of burst trigger circuitry is available, resulting in various available burst trigger bandwidths. The analyzer automatically chooses the appropriate trigger path based on the hardware configuration and other settings of the analyzer.

Key Path	Trigger
<b>Example</b>	TRIG:SOUR RFB Swept SA measurement TRIG:<meas>:SOUR RFB Measurements other than Swept SA
State Saved	Saved in instrument state
Status Bits/OPC dependencies	The Status Operation Register bit 5 "Waiting for Trigger" is set at the same time as the Sweeping or Measuring bit is set. It is cleared when the trigger actually occurs (that is, after the trigger event)

	occurs and all the applicable trigger criteria have been met). A corresponding pop-up message ("Waiting for trigger") is generated if no trigger signal appears after approximately 2 sec. This message goes away when a trigger signal appears.
Backwards Compatibility Notes	The legacy command: :TRIGger[:SEquence]:RFBurst:FSElectivity[:STATe] OFF ON 0 1 is not supported in the X-Series, as the hardware to do Frequency Selective burst triggers does not exist in X-Series.
Initial S/W Revision	Prior to A.02.00
Modified at S/W Revision	A.04.00

### Absolute Trigger Level

Sets the absolute trigger level for the RF burst envelope.

When using the External Mixing path, the Absolute Trigger Level is uncalibrated because the factory default was set to accommodate the expected IF levels for the RF path.

Key Path	Trigger, RF Burst
Scope	Meas Global
Remote Command	:TRIGger[:SEquence]:RFBurst:LEVel:ABSolute <ampl> :TRIGger[:SEquence]:RFBurst:LEVel:ABSolute?
Example	TRIG:RFB:LEV:ABS 10 dBm sets the trigger level of the RF burst envelope signal to the absolute level of 10 dBm
Notes	Sending this command does not switch the setting from relative to absolute; to switch it you need to send the :TRIGger[:SEquence]:RFBurst:LEVel:TYPE command, below.  Amplitude Corrections are not taken into account by the Absolute Trigger Level. For example, if you have given yourself effective gain with an amplitude correction factor, the Absolute Trigger will not fire until you have set the trigger level that far below the displayed signal level, rather than simply to the displayed signal level. This is only true for Amplitude Corrections, not External Gain or Ref Level Offset functions.  If mode is Bluetooth, the default value is -50 dBm.
Couplings	This same level is used for the RF Burst trigger source in the Trigger menu, for the RF Burst selection in the Periodic Timer sync source (in the Trigger menu and in the Gate Source menu), and also for the RF Burst selection in the Gate Source menu
Preset	-20 dBm
State Saved	Saved in instrument state
Min	-200 dBm
Max	100 dBm
Default Unit	depends on the current selected Y-Axis unit
Backwards Compatibility SCPI	:TRIGger[:SEquence]:FRAME:RFBurst:LEVel:ABSolute
Initial S/W Revision	Prior to A.02.00
Modified at S/W Revision	A.04.00

Key Path	Trigger, RF Burst
Remote Command	:TRIGger[:SEquence]:RFBurst:LEVel:TYPE ABSolute RELative :TRIGger[:SEquence]:RFBurst:LEVel:TYPE?
Example	TRIG:RFB:LEV:TYPE REL sets the trigger level type of the RF burst trigger to Relative.
Preset	ABSolute
State Saved	Saved in instrument state
Initial S/W Revision	Prior to A.02.00
Modified at S/W Revision	A.04.00

### Trigger Slope

It is set positive to trigger on a rising edge and negative to trigger on a falling edge.

Key Path	Trigger, RF Burst
Remote Command	:TRIGger[:SEquence]:RFBurst:SLOPe POSitive NEGative :TRIGger[:SEquence]:RFBurst:SLOPe?
Example	TRIG:RFB:SLOP NEG
Couplings	This same slope is used in the RF Burst selection for the trigger source in the Trigger menu and for the period timer sync source (in the Trigger menu and in the Gate Source menu).
Preset	POSitive
State Saved	Saved in instrument state
Backwards Compatibility SCPI	:TRIGger[:SEquence]:FRAMe:RFBurst:SLOPe
Backwards Compatibility Notes	The legacy :TRIGger[:SEquence]:SLOPe command affects the slopes for the VID, LINE, EXT1, EXT2, and RFB triggers.
Initial S/W Revision	Prior to A.02.00

### Sync Holdoff

Sync Holdoff specifies the duration that the sync source signal must be kept false before the transition to true to be recognized as the sync timing. The periodic timer phase is aligned when the sync source signal becomes true, after the Holdoff time is satisfied.

A holdoff of 2 ms will work with most WiMAX signals, but there may be cases where the burst off duration is less than 1 ms and this value will need to be changed.

Key Path	Trigger, Periodic Timer
Remote Command	:TRIGger[:SEquence]:FRAMe:SYNC:HOLDoff <time> :TRIGger[:SEquence]:FRAMe:SYNC:HOLDoff?

	<code>:TRIGger[:SEquence]:FRAMe:SYNC:HOLDoff:STATe OFF ON 0 1</code>
	<code>:TRIGger[:SEquence]:FRAMe:SYNC:HOLDoff:STATe?</code>
Preset	On, 1.000 ms
State Saved	Saved in instrument state
Min	0 ms
Max	+500 ms
Default Unit	s
Initial S/W Revision	Prior to A.02.00

### Auto/Holdoff

Opens up a menu that lets you adjust Auto Trigger and Trigger Holdoff parameters

Key Path	Trigger
Readback line	Displays a summary of the Auto Trig and Holdoff settings, in square brackets First line: Auto Off or Auto On Second Line: "Hldf" followed by: <ul style="list-style-type: none"> <li>• If Holdoff is Off, readback Off</li> <li>• If Holdoff On and Type = Normal, readback value</li> <li>• If Holdoff On and Type = Above, readback value followed by AL</li> <li>• If Holdoff On and Type = Below, readback value followed by BL</li> <li>• If Holdoff Type selection is not supported by the current measurement, Holdoff Type is always Normal</li> </ul>
Initial S/W Revision	A.02.00

### Auto Trig

Sets the time that the analyzer will wait for the trigger conditions to be met. If they are not met after that much time, then the analyzer is triggered anyway.

Key Path	Trigger, Auto/Holdoff
Remote Command	<code>:TRIGger[:SEquence]:ATRigger &lt;time&gt;</code> <code>:TRIGger[:SEquence]:ATRigger?</code> <code>:TRIGger[:SEquence]:ATRigger:STATe OFF ON 0 1</code> <code>:TRIGger[:SEquence]:ATRigger:STATe?</code>
Example	TRIG:ATR:STAT ON TRIG:ATR 100 ms
Notes	The "time that the analyzer will wait" starts when the analyzer is ready for a trigger, which may be hundreds of ms after the data acquisition for a sweep is done. The "time" ends when the trigger condition is satisfied, not when the delay ends.



Preset	Off, 100 ms
State Saved	Saved in instrument state
Min	1 ms
Max	100 s
Default Unit	s
Initial S/W Revision	Prior to A.02.00

### Trig Holdoff

Sets the holdoff time between triggers. When the trigger condition is satisfied, the trigger occurs, the delay begins, and the holdoff time begins. New trigger conditions will be ignored until the holdoff time expires. For a free-running trigger, the holdoff value is the minimum time between triggers.

Key Path	Trigger, Auto/Holdoff
<b>Remote Command</b>	:TRIGger[:SEquence]:HOLDoff <time> :TRIGger[:SEquence]:HOLDoff? :TRIGger[:SEquence]:HOLDoff:STATe OFF ON 0 1 :TRIGger[:SEquence]:HOLDoff:STATe?
<b>Example</b>	TRIG:HOLD:STAT ON TRIG:HOLD 100 ms
Dependencies	Unavailable if the selected Input is BBIQ. If this is the case, the key is grayed out if it is pressed the informational message “Feature not supported for this Input” is displayed. If the SCPI command is sent, the error “Settings conflict; Feature not supported for this Input” is generated.
Preset	Off, 100 ms
State Saved	Saved in instrument state
Min	0 s
Max	0.5 s
Default Unit	s
Initial S/W Revision	Prior to A.02.00

### Gate Preset (Remote Command Only)

Presets the time-gated spectrum analysis capability.

This command sets gate parameter values to the ESA preset values, as follows:

Gate delay = 1 us

Gate length = 1 us

<b>Remote Command</b>	[:SENSe]:SWEep:TIME:GATE:PRESet ESA Compatibility
Initial S/W Revision	Prior to A.02.00

### Gate Level (Remote Command Only)

Sets the gate input transition point level for the external TRIGGER inputs on the front and rear panel. This is a legacy command for PSA compatibility. It is simply an alias to the equivalent trigger level command.

<b>Remote Command</b>	<code>[ :SENSe ] :SWEep:EGATe:EXTeRnal [ 1 ]   2 :LEVel &lt;voltage&gt;</code> <code>[ :SENSe ] :SWEep:EGATe:EXTeRnal [ 1 ]   2 :LEVel?</code>
<b>Notes</b>	This command is simply an alias to <code>:TRIGger[:SEQuence]:EXTeRnal[1] 2:LEVel</code> For details refer
<b>Initial S/W Revision</b>	Prior to A.02.00

### Gate Polarity (Remote Command Only)

Sets the polarity for the gate signal. This setup is now done using the gate trigger's slope setting.

When Positive (Pos) is selected, a positive-going edge (Edge) or a high voltage (Level) will satisfy the gate condition, after the delay set with the Gate Delay key. When Negative (Neg) is selected, a negative-going edge (Edge) or a low voltage (Level) will satisfy the gate condition after the delay.

<b>Remote Command</b>	<code>[ :SENSe ] :SWEep:EGATe:POLarity NEGative POSitive</code> <code>[ :SENSe ] :SWEep:EGATe:POLarity?</code>
<b>Example</b>	<code>SWE:EGAT:POL NEG</code> <code>SWE:EGAT:POL?</code>
<b>Preset</b>	POSitive
<b>State Saved</b>	Saved in instrument state
<b>Backwards Compatibility SCPI</b>	<code>[ :SENSe ] :SWEep:TIME:GATE:POLarity</code> ESA compatibility
<b>Initial S/W Revision</b>	Prior to A.02.00

<b>Remote Command</b>	<code>[ :SENSe ] :SWEep:TIME:GATE:LEVel HIGH LOW</code> <code>[ :SENSe ] :SWEep:TIME:GATE:LEVel?</code> ESA compatibility
<b>Preset</b>	HIGH
<b>Initial S/W Revision</b>	Prior to A.02.00

### Points

Sets the number of points per sweep, from 1 to 20001. The sweep time resolution setting will depend on the number of points selected.

Key Path	Sweep/Control
Mode	SA, WCDMA, C2K, WIMAX OFDMA, TD-SCDMA, 1xEVDO, DVB-T/H, DTMB (CTTB), ISDB-T, CMMB, LTE, LTE-TDD, Digital Cable TV, MSR, LTEAFDD, LTEATDD
<b>Remote Command</b>	[ :SENSe ] :ACPower:SWEep:POINts <integer> [ :SENSe ] :ACPower:SWEep:POINts?
<b>Example</b>	ACP:SWE:POIN 500 ACP:SWE:POIN?
Notes	Whenever the number of sweep points changes: <ul style="list-style-type: none"> <li>• All trace data is erased</li> <li>• Any traces with Update Off will also go to Display Off (like going from View to Blank in the older analyzers)</li> <li>• Sweep time is re-quantized</li> <li>• Any limit lines that are on will be updated</li> <li>• If averaging/hold is on, averaging/hold starts over</li> </ul>
Couplings	Whenever the number of sweep points changes, the sweep time is re-quantized.
Preset	Others: 1001 DVB-T/H:2001 DTMB (CTTB): 2001 ISDB-T: 2001 CMMB: 2001 Digital Cable TV: 2001
State Saved	Saved in instrument state.
Min	1
Max	20001
Initial S/W Revision	Prior to A.02.00
Modified at S/W Revision	A.02.00, A.03.00

## System

See "[System](#)" on page 184

## Trace/Detector

Accesses a menu of functions that enable you to control the detectors for the current measurement.

Key Path	Front-panel key
Initial S/W Revision	Prior to A.02.00

### Select Trace (Front-panel Only)

This key selects which trace the other parameters under the Trace/Detector menu will apply to.

Key Path	Trace/Detector
Notes	Front-panel only.
Couplings	When Meas Method is RBW or FAST, Select Trace is disabled.
Preset	1
State Saved	Saved in instrument state.
Range	1   2   3
Initial S/W Revision	Prior to A.02.00

### Trace Type

Allows you to select the type of trace for the current measurement. The first page of this menu contains a selection of the trace type (Clear Write, Trace Average, Max Hold, Min Hold) for the selected trace.

Key Path	Trace/Detector
Mode	SA, WCDMA, C2K, WIMAX OFDMA, TD-SCDMA, 1xEVDO, DVB-T/H, DTMB (CTTB), ISDB-T, CMMB, LTE, LTE-TDD, Digital Cable TV, MSR, LTEAFDD, LTEATDD
<b>Remote Command</b>	:TRACe [1]   2   3 :ACPoweR :TYPE WRITe   AVERAge   MAXHold   MINHold :TRACe [1]   2   3 :ACPoweR :TYPE?
<b>Example</b>	TRAC:ACP:TYPE MINH TRAC:ACP:TYPE?
Notes	WRITe = Clear Write AVERAge = Average MAXHold = Maximum Hold MINHold = Minimum Hold
Couplings	When Detector setting is "Auto" (:SENSe]:ACPoweR:DETEctor:AUTO?), Detector is set to what the Radio Standard defaults states (see detector section below) for all conditions of Trace Type and for all traces. When set to Manual, all Traces use the same detector type. When Average State = Off then Trace Types AVERAge, MaxHold and MinHold will not function, since Averaging is required to be 'on' for them to operate.

	When Meas Method is RBW or FAST, Trace Type is disabled.
Preset	AVERage
State Saved	Saved in instrument state.
Initial S/W Revision	Prior to A.02.00
Modified at S/W Revision	A.02.00, A.03.00

## View/Blank

Enables you to select how to view the displayed trace.

Key Path	Trace/Detector
Mode	SA,WCDMA, C2K, WIMAX OFDMA, TD-SCDMA, 1xEVDO, DVB-T/H, DTMB (CTTB), ISDB-T, CMMB, LTE, LTETDD, Digital Cable TV, MSR, LTEAFDD,LTEATDD
Notes	No remote control. Front panel only.
Couplings	The four states of this 1-of-N actually set two variables, Update and Display, to their four possible combinations. Trace On: Update and Display both On View: Update Off and Display On (Not implemented) Blank: Update Off and Display Off Background: Update On, Display Off (Not implemented) See tables below for detail on remote commands to control these two variables. Selecting a trace type (Clear Write, Trace Average, Max Hold, Min Hold) for a trace (pressing the key or sending the equivalent remote command) puts the trace in 'Trace On' state (Update On and Display On), even if that trace type was already selected. When Meas Method is RBW or FAST, this key is grayed out.
Preset	Trace On
State Saved	Saved in instrument state.
Range	Trace On Blank
Initial S/W Revision	Prior to A.02.00
Modified at S/W Revision	A.03.00

Key Path	Trace/Detector
Mode	WCDMA, C2K, WIMAX OFDMA, TD-SCDMA, 1xEVDO, DVB-T/H, DTMB (CTTB), ISDB-T, CMMB, LTE, LTETDD, Digital Cable TV, MSR, LTEAFDD,LTEATDD
Remote Command	:TRACe [1]   2   3 :ACPoweR:UPDate [ :STATe] ON OFF 0 1 :TRACe [1]   2   3 :ACPoweR:UPDate [ :STATe] ?
Example	TRAC:ACP:UPD ON TRAC:ACP:UPD?
Couplings	Whenever you set Update to On for any trace, the Display is set to On for that trace. When Meas Method is RBW or FAST, Trace Update is disabled.
Preset	1 0 0 (On for Trace 1; Off for 2 &3)

State Saved	Saved in instrument state.
Range	0 1
Initial S/W Revision	Prior to A.02.00
Modified at S/W Revision	A.03.00
<hr/>	
Key Path	Trace/Detector
Mode	WCDMA, C2K, WIMAX OFDMA, TD-SCDMA, 1xEVDO, DVB-T/H, DTMB (CTTB), ISDB-T, CMMB, LTE, LTETDD, Digital Cable TV, MSR, LTEAFDD, LTEATDD
<b>Remote Command</b>	:TRACe[1] 2 3:ACPoweR:DISPlay[:STATe] ON OFF 0 1 :TRACe[1] 2 3:ACPoweR:DISPlay[:STATe]?
<b>Example</b>	TRAC:ACP:DISP ON TRAC:ACP:DISP?
Couplings	Whenever you set Update to On for any trace, the Display is set to On for that trace. When Meas Method is RBW or FAST, Trace Display is disabled.
Preset	1 0 0 (On for Trace 1; Off for 2 & 3)
State Saved	Saved in instrument state.
Range	0 1
Initial S/W Revision	Prior to A.02.00
Modified at S/W Revision	A.03.00

## Detector

Accesses a menu of functions that enables you to control the detectors for the current measurement. Allows up to three (3) traces, but each use the same detector type choice. The following choices are available:

- Auto– the detector selected is set to AVERage, unless the Radio Standard defaults state otherwise e.g. it is set to Peak for Radio Standard = PDC when Device = both MS and BTS, and when Radio Standard = NADC and Device = MS.
- Normal–the detector determines the peak of the CW-like signals, and it yields alternating maximums and minimums of noise-like signals. This is also referred to as Rosenfell detection.
- Average–the detector determines the average of the signal within the sweep points. The averaging method is Power (RMS).
- Peak–the detector determines the maximum of the signal within the sweep points.
- Sample–the detector indicates the instantaneous level of the signal at the center of the sweep points represented by each display point.
- Negative Peak–the detector determines the minimum of the signal within the sweep points.

In swept analysis, the time interval of the data collection for the display sweep points also represents a frequency interval. In FFT analysis, the sweep points represents just a frequency interval. The detector

determines the relationship between the spectrum computed by the FFT and the single data point displayed for the sweep points.

Key Path	Trace/Detector
Initial S/W Revision	Prior to A.02.00

## Auto

Sets the detector for the currently selected trace to auto.

Key Path	Trace/Detector
Mode	SA, WCDMA, C2K, WIMAX OFDMA, TD-SCDMA, 1xEVDO, DVB-T/H, DTMB (CTTB), ISDB-T, CMMB, LTE, LTETDD, Digital Cable TV, MSR, LTEAFDD, LTEATDD
<b>Remote Command</b>	<code>[ :SENSe ] :ACPower:DETECTOR:AUTO ON OFF 1 0</code> <code>[ :SENSe ] :ACPower:DETECTOR:AUTO?</code>
<b>Example</b>	ACP:DET:AUTO 1 ACP:DET?
Couplings	When Detector setting is "Auto" ( <code>[ :SENSe ] :ACPower:DETECTOR:AUTO?</code> ), Detector is set to what the Radio Standard defaults states (see detector section) for all conditions of Trace Type and for all traces. When set to Manual, all Traces use the same detector type. When Average State = Off then Trace Types AVERage, MaxHold and MinHold will not function, since Averaging is required to be 'on' for them to operate.
Preset	ON
State Saved	Saved in instrument state.
Range	ON OFF
Initial S/W Revision	Prior to A.02.00
Modified at S/W Revision	A.02.00, A.03.00

## Detector Selection

Selects a detector to be used by the analyzer for the current measurement. All traces will use the same detector type, similar to Monitor Spectrum measurement

Key Path	Trace/Detector
Mode	SA, WCDMA, C2K, WIMAX OFDMA, TD-SCDMA, 1xEVDO, DVB-T/H, DTMB (CTTB), ISDB-T, CMMB, LTE, LTETDD, Digital Cable TV, MSR, LTEAFDD, LTEATDD
<b>Remote Command</b>	<code>[ :SENSe ] :ACPower:DETECTOR[:FUNCTION] AVERage   NEGative   NORMal   POSitive   SAMPlE</code> <code>[ :SENSe ] :ACPower:DETECTOR[:FUNCTION]?</code>
<b>Example</b>	ACP:DET NORM ACP:DET?
Notes	When you manually select a detector (instead of selecting Auto), that detector is used regardless of



other analyzer settings.

The detector choices are:

- The Normal detector determines the peak of CW-like signals, and it yields alternating maximums and minimums of noise-like signals. This is also referred to as Rosenfell detection.
- The Average detector determines the average of the signal within the data range. The averaging method is Power (RMS).
- The Peak detector determines the maximum of the signal within the data range.
- The Sample detector indicates the instantaneous level of the signal at the center of the data represented by each display point.
- The Negative Peak detector determines the minimum of the signal within the data range.

Because they may not find a spectral component's true peak, neither average nor sample detectors measure amplitudes of CW signals as accurately as peak or normal, but they do measure noise without the biases of peak detection.

When a detector selection is made, the menu returns to the previous menu.

Couplings	<p>When Detector setting is "Auto" (:SENSe]:ACPower:DETECTOR:AUTO?), Detector is set to what the Radio Standard defaults states (see detector section) for all conditions of Trace Type and for all traces. When set to Manual, all Traces use the same detector type. When Average State = Off then Trace Types AVERage, MaxHold and MinHold will not function, since Averaging is required to be 'on' for them to operate.</p> <p>Only one detector type for all 3 traces is allowed.</p> <p>When Meas Method is RBW or FAST, Detector is disabled.</p>
Preset	AVERage
State Saved	Saved in instrument state.
Range	Normal Average Peak Sample Negative Peak
<b>Backwards Compatibility SCPI</b>	[ :SENSe ] :ACPR :SWEep :DETECTOR [ :FUNCTION ]
Initial S/W Revision	Prior to A.02.00
Modified at S/W Revision	A.02.00, A.03.00

## Trigger

See ["Trigger" on page 244](#)

### Free Run

See ["Free Run " on page 251](#)

### Video

See ["Video \(IF Envelope\) " on page 1160](#)

### Trigger Level

See ["Trigger Level " on page 1161](#)

### Trig Slope

See ["Trig Slope " on page 1162](#)

### Trig Delay

See ["Trig Delay " on page 254](#)

### External 1

See ["External 1 " on page 1175](#)

### Trigger Level

See ["Trigger Level " on page 1175](#)

### Trig Slope

See ["Trig Slope " on page 1176](#)

### Trig Delay

See ["Trig Delay " on page 257](#)

### Zero Span Delay Comp

See ["Zero Span Delay Comp On/Off " on page 1164](#)

### External 2

See ["External 2 " on page 1177](#)

### Trigger Level

See ["Trigger Level " on page 1177](#)

### Trig Slope

See ["Trig Slope " on page 1178](#)

## Trig Delay

See "Trig Delay " on page 260

## Zero Span Delay Comp

See "Zero Span Delay Comp On/Off" on page 1166

## RF Burst

See "RF Burst " on page 1178

## Absolute Trigger

See "Absolute Trigger Level" on page 1179

## Relative Trigger

See "Relative Trigger Level" on page 1168

## Trig Slope

See "Trigger Slope " on page 1180

## Trig Delay

See "Trig Delay " on page 264

## Periodic Timer

See "Periodic Timer (Frame Trigger) " on page 1170

## Period

See "Period " on page 1171

## Offset

See "Offset " on page 1172

## Reset Offset Display

See "Reset Offset Display " on page 1174

## Sync Source

See "Sync Source " on page 1174

## Off

See "Off " on page 1175

## External 1

See "External 1 " on page 1175

**Trigger Level**

See ["Trigger Level "](#) on page 1175

**Trig Slope**

See ["Trig Slope "](#) on page 1176

**External 2**

See ["External 2 "](#) on page 1177

**Trigger Level**

See ["Trigger Level "](#) on page 1177

**Trig Slope**

See ["Trig Slope "](#) on page 1178

**RF Burst**

See ["RF Burst "](#) on page 1178

**Absolute Trigger**

See ["Absolute Trigger Level"](#) on page 1179

**Trig Slope**

See ["Trigger Slope "](#) on page 1180

**Trig Delay**

See ["Trig Delay"](#) on page 275

**Auto/Holdoff**

See ["Auto/Holdoff "](#) on page 1181

**Auto Trig**

See ["Auto Trig "](#) on page 1181

**Trig Holdoff**

See ["Trig Holdoff "](#) on page 1182

**Internal**

See ["Internal"](#) on page 277

## User Preset

Accesses a menu that gives you the following three choices:

- User Preset – recalls a state previously saved using the Save User Preset function.
- User Preset All Modes – presets all of the modes in the analyzer
- Save User Preset– saves the current state for the current mode

### NOTE

In products that run multiple instances of the X-Series Application, all instances use the same location to save User Preset state. So Save User Preset of one instance will overwrite the Save User Preset of another instance.

Key Path	Front-panel key
Backwards Compatibility Notes	<p>User Preset is actually loading a state, and in legacy analyzers, it was possible to load a state without affecting the trace data, limit lines or correction data. Similarly it was possible to do a User Preset without affecting the trace data, limit lines or correction data.</p> <p>In the X-Series, “state” always includes all of this data; so whenever state is loaded, or User Preset is executed, all of the traces, limit lines and corrections are affected. Although this differs from previous behavior, it is desirable behavior, and should not cause adverse issues for users.</p> <p>On ESA and PSA, User Preset affected the entire instrument’s state. In the X-Series, User Preset only recalls the state for the active mode. There is a User Preset file for each mode. User Preset can never cause a mode switch as it can in legacy analyzers. If you want to recall all modes to their user preset file state, you will need to do a User Preset after mode switching into each mode.</p> <p>User Preset recalls mode state which can now include data like traces; whereas on ESA and PSA, User Preset did not affect data.</p>
Initial S/W Revision	Prior to A.02.00

## User Preset

User Preset sets the state of the currently active mode back to the state that was previously saved for this mode using the Save User Preset menu key or the SCPI command, SYST:PRES:USER:SAV. It not only recalls the Mode Preset settings, but it also recalls all of the mode persistent settings, and the Input/Output system setting that existed at the time Save User Preset was executed.

If a Save User Preset has not been done at any time, User Preset recalls the default user preset file for the currently active mode. The default user preset files are created if, at power-on, a mode detects there is no user preset file. There will never be a scenario when there is no user preset file to restore. For each mode, the default user preset state is the same state that would be saved if a Save User Preset is performed in each mode right after doing a Restore Mode Default and after a Restore Input/Output Defaults.

The User Preset function does the following:

- Aborts the currently running measurement.
- Sets the mode State to the values defined by Save User Preset.
- Makes the saved measurement for the currently running mode the active measurement.
- Brings up the saved menu for the power-on mode.

- Clears the input and output buffers.
- Sets the Status Byte to 0.

Key Path	User Preset
Remote Command	:SYSTem:PRESet:USER
Example	:SYST:PRES:USER:SAVE:SYST:PRES:USER
Notes	:SYST:PRES:USER:SAVE is used to save the current state as the user preset state. Clears all pending OPC bits. The Status Byte is set to 0. Pressing the User Preset front-panel key while already in the User Preset menu will cause the User Preset to get executed
Couplings	A user preset will cause the currently running measurement to be aborted and cause the saved measurement to be active. Recalling a User Preset file has the same issues that recalling a Save State file has. Some settings may need to be limited and therefore re-coupled, since the capabilities of the mode may have changes when the User Preset file was last saved.
Initial S/W Revision	Prior to A.02.00

### User Preset All Modes

Recalls all of the User Preset files for each mode, switches to the power-on mode, and activates the saved measurement from the power-on mode User Preset file.

**NOTE**

When the instrument is secured, all of the user preset files are converted back to their default user preset files.

The User Preset function does the following:

- Aborts the currently running measurement.
- Switches the Mode to the power-on mode.
- Restores the User Preset files for each mode.
- Makes the saved measurement for the power-on mode the active measurement.
- Brings up the saved menu for the power-on mode.
- Clears the input and output buffers.
- Sets the Status Byte to 0.

Key Path	User Preset
Remote Command	:SYSTem:PRESet:USER:ALL
Example	:SYST:PRES:USER:SAVE:SYST:PRES:USER:ALL
Notes	Clears all pending OPC bits. The Status Byte is set to 0. :SYST:PRES:USER:SAVE is used to save the current state as the user preset state.
Couplings	A user preset will cause the currently running measurement to be aborted, cause a mode switch to the power-on mode, and cause the saved measurement to be active in the power-on mode.

---

Recalling a User Preset file has the same issues that recalling a Save State file has. Some settings may need to be limited and therefore re-coupled, since the capabilities of the mode may have changes when the User Preset file was last saved.

---

Initial S/W Revision      Prior to A.02.00

---

## Save User Preset

Saves the currently active mode and its State. You can recall this User Preset file by pressing the User Preset menu key or sending the SYST:PRES:USER remote command. This same state is also saved by the Save State function.

Key Path	User Preset
<b>Remote Command</b>	:SYSTem:PRESet:USER:SAVE
<b>Example</b>	:SYST:PRES:USER:SAVE
Notes	:SYST:PRES:SAVE creates the same file as if the user requested a *SAV or a MMEM:STOR:STAT, except User Preset Save does not allow the user to specify the filename or the location of the file.
Initial S/W Revision	Prior to A.02.00

## View/Display

Accesses a menu of functions that enable you to control the instrument display as well as turn the bar graph On and Off.

If current mode is NOT MSR and LTE-Advanced FDD/TDD mode, the front panel views only contain one view: Spectrum View.

The results of the measurement can be displayed as a single spectrum trace view or displayed with a Bar Graph trace on the spectrum trace.

The display consists of the following two windows:

"Spectrum Window" on page 870

"Results Window" on page 870

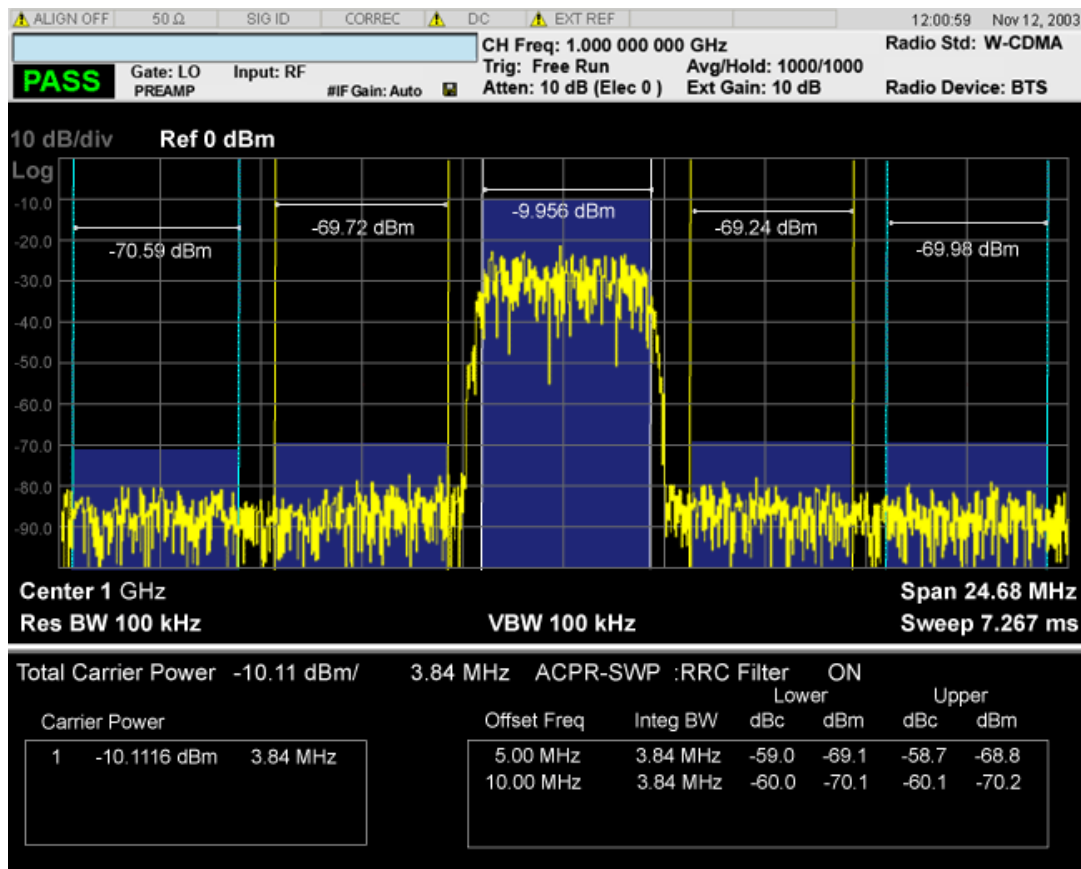

The following two views are only for DTMB (CTTB) and CMMB:

DTMB and CMMB Transmitter:



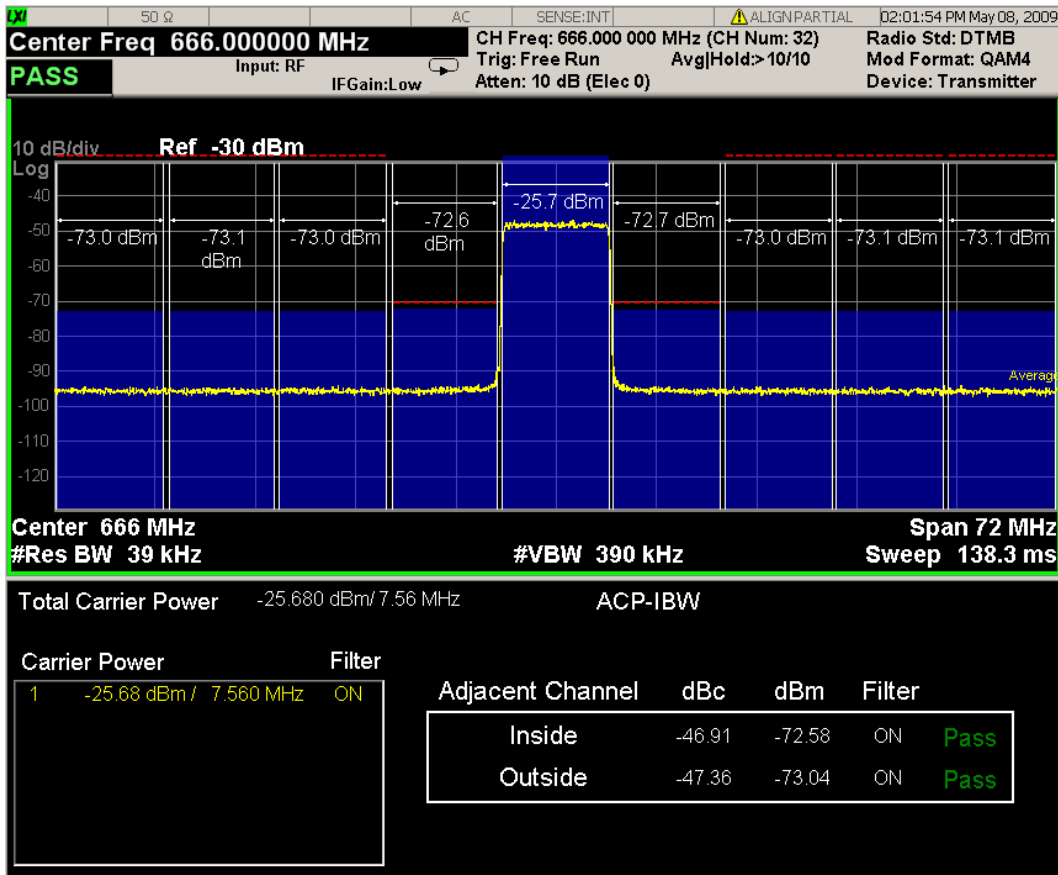

DTMB and CMMB Exciter:

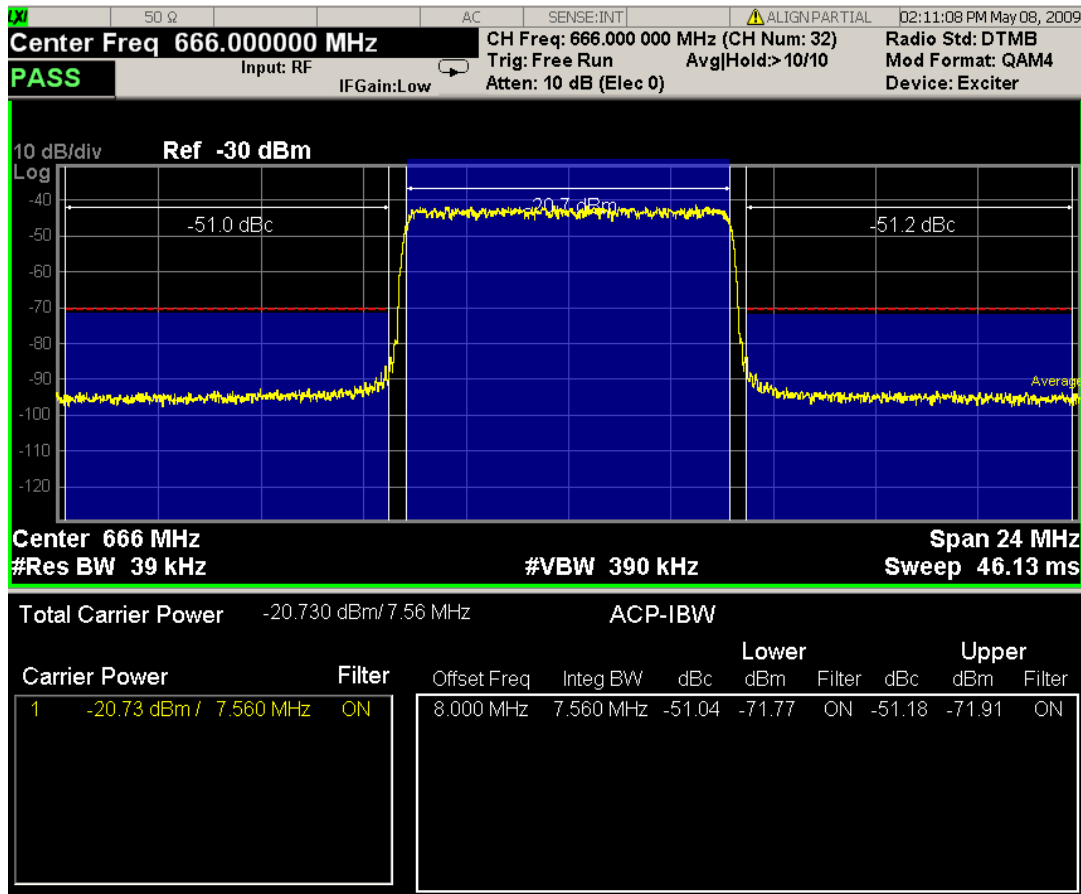

### Spectrum Window

When the Bar Graph is On and Limit Test is On, the color of each bar graph reflects the limit test result. When the limit test fails, the bar color is red, and when limit test passes, the bar color is blue.

When RBW is selected as the measurement method, the spectrum trace is not displayed, only the bar graph is displayed. In addition, the Bar Graph key (under the View/Display front-panel key) is set to ON and is grayed out.

The RRC Filter display item is only displayed when RRC filter is on.

### Results Window

The text window displays the following results:

#### Total Carrier Power

This is the total power of all the carriers with carrier power present set to yes. The power is calculated by integrating across the bandwidth declared by the Carrier Integ Bw parameter for each carrier and then totaling the sums. The total integration bandwidth is shown as part of the result. This will be the total of the Carrier Integ Bw of the carriers used in calculating the total carrier power. If the RRC Filter is on, then the integration bandwidth used is  $(1 + \alpha)/T$  where  $T = 1/(\text{Carrier Integ Bw})$  multiplied by the number of carriers with carrier power present set to yes.

#### Ref Carrier Power

This is the power in the reference carrier. The power is calculated by integrating across the bandwidth declared by the Carrier Integ Bw parameter for that carrier. The integration bandwidth is shown as part of the result. This is the value of the Carrier Integ Bw for that carrier unless the RRC Filter is on, then the integration bandwidth used is the displayed value, which is  $(1 + \alpha)/T$  where  $T = 1/(\text{Carrier Integ Bw})$ .

#### **Carrier Power**

This is the power in all the currently defined carriers. If the carrier has carrier power present, the power will be absolute. If the carrier is defined as not having power present, the power will be relative to the reference carrier. The power is calculated by integrating across the bandwidth declared by the Carrier Integ Bw parameter. The integration bandwidth is shown as part of the result. This is the value of the Carrier Integ Bw for the carrier unless the RRC Filter is on, then the integration bandwidth used is the displayed value, which is  $(1 + \alpha)/T$  where  $T = 1/(\text{Carrier Integ Bw})$ .

As there are potentially more results than can be easily viewed on the display, a scrollable list is used to display all results. The Carrier Results menu key is used to index the carrier amplitude results. This key is grayed out unless the measurement is in single mode (as in continual measurement mode). The display is continuously updating and will not need to be accessed. The currently selected Carrier Result is displayed on the last line of the carrier power result list unless:

- The selected Carrier Result is 4 or less in normal multi carrier power results view. In this case the first 4 carrier power results will be displayed.
- The selected Carrier Result is 9 or greater in normal multi carrier power results view. In this case the last 4 carrier power results will be displayed.
- The zoom mode is selected. In this case all carrier power ranges can be displayed.

#### **Offset Relative Power**

This is the power in the offsets relative to the reference carrier. The power is calculated by integrating across the bandwidth declared by the Offset Integ Bw parameter. The offset integration bandwidth is shown as part of the result. This is the value on the Offset Integ Bw menu key unless the RRC Filter is on, then the integration bandwidth used is the displayed value, which is  $(1 + \alpha)/T$  where  $T = 1/(\text{Offset Integ Bw})$ .

#### **Offset Absolute Power**

This is the absolute power in the offsets. The power is calculated by integrating across the bandwidth declared by the Offset Integ Bw parameter. The offset integration bandwidth is shown as part of the result. This is the value on the Offset Integ Bw menu key unless the RRC Filter is on, then the integration bandwidth used is the displayed value, which is  $(1 + \alpha)/T$  where  $T = 1/(\text{Offset Integ Bw})$ .

#### **Inside Adjacent Channel Power (DTMB (CTTB) and CMMB only)**

This result is only valid for DTMB (CTTB) transmitter and CMMB transmitter. It contains two parts: Relative Power and Absolute Power. The power is calculated by integrating across the bandwidth (Integ Bw) at the frequency Offset A.

Inside Absolute Power =  $\text{MAX}(P_{\text{Lower Offset A}}, P_{\text{Upper Offset A}})$ ;

Inside Relative Power = Inside Absolute Power – Carrier Power;

#### **Outside Adjacent Channel Absolute Power (DTMB (CTTB) and CMMB only)**

This result is only valid for DTMB (CTTB) transmitter and CMMB transmitter. It contains two parts: Relative Power and Absolute Power. The power is the Root-Mean-Square of the power calculated by integrating across the bandwidth (Integ Bw) at frequency Offset B, C and D.

$$\text{Outside Absolute Power} = \sqrt{\frac{P_{\text{Lower OffsetB}}^2 + P_{\text{Upper OffsetB}}^2 + P_{\text{Lower OffsetC}}^2 + P_{\text{Upper OffsetC}}^2 + P_{\text{Lower OffsetD}}^2 + P_{\text{Upper OffsetD}}^2}{6}}$$

Outside Relative Power = Outside Absolute Power – Carrier Power;

Key Path	Front-panel key
Initial S/W Revision	Prior to A.02.00

## Display

The Display menu is common to most measurements, and is used for configuring items on the display. Some Display menu settings apply to all the measurements in a mode, and some only to the current measurement. Those under the System Display Settings key apply to all measurements in all modes.

Key Path	Display
Key Path	View/Display
Initial S/W Revision	Prior to A.02.00

## Annotation

Turns on and off various parts of the display annotation. The annotation is divided up into four categories:

1. Meas Bar: This is the measurement bar at the top of the screen. It does not include the settings panel or the Active Function. Turning off the Meas Bar turns off the settings panel and the Active Function. When the Meas Bar is off, the graticule area expands to fill the area formerly occupied by the Meas Bar.
2. Screen Annotation: this is the annotation and annunciation around the graticule, including any annotation on lines (such as the display line, the threshold line, etc.) This does NOT include the marker number or the N dB result. When off, the graticule expands to fill the entire graticule area.
3. Trace annotation: these are the labels on the traces, showing their detector (or their math mode).
4. Active Function annotation: this is the active function display in the meas bar, and all of the active function values displayed on softkeys.

See the figure below. Each type of annotation can be turned on and off individually.

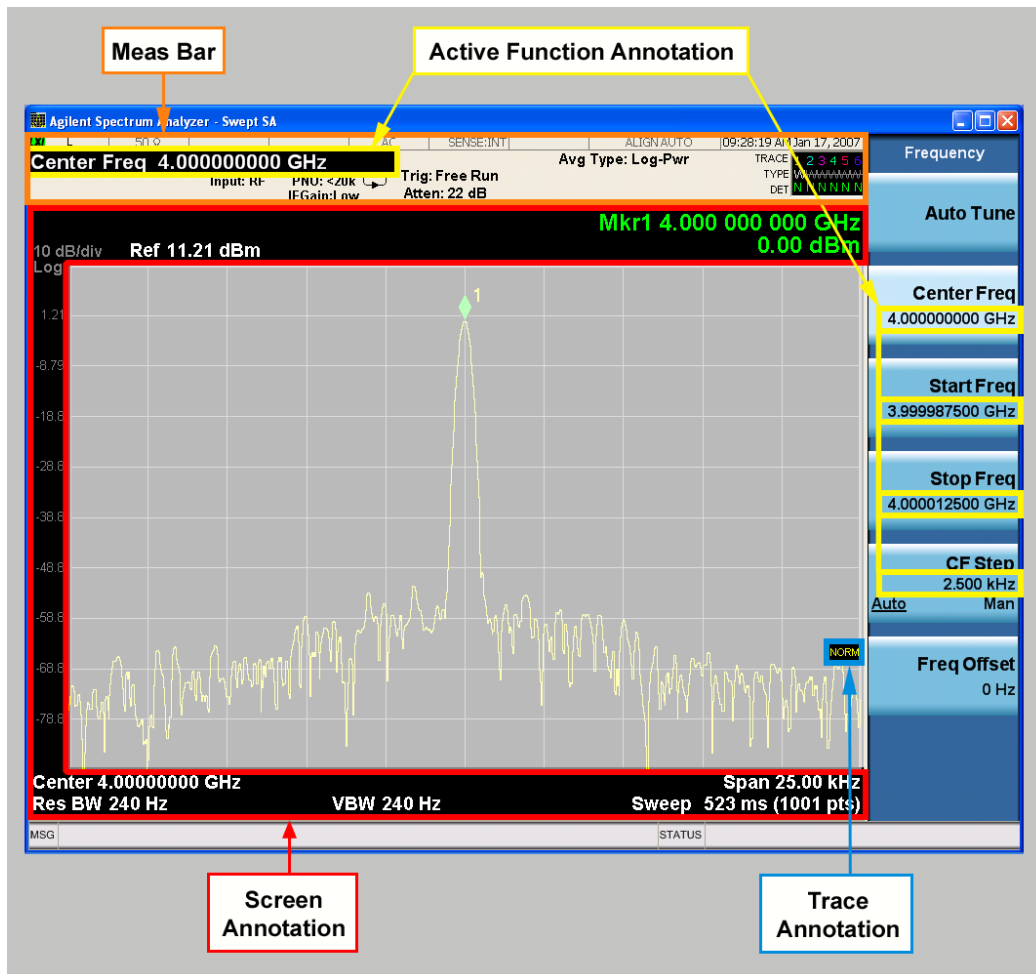

Key Path	View/Display, Display
Initial S/W Revision	Prior to A.02.00

### Meas Bar On/Off

This function turns the Measurement Bar on and off, including the settings panel. When off, the graticule area expands to fill the area formerly occupied by the Measurement Bar.

Key Path	View/Display, Display, Annotation
Remote Command	:DISPlay:ANNotation:MBAR[:STATE] OFF ON 0 1 :DISPlay:ANNotation:MBAR[:STATE]?
Example	DISP:ANN:MBAR OFF
Dependencies	Grayed out and forced to OFF when System Display Settings, Annotation is set to Off.
Preset	On This should remain Off through a Preset when System DisplaySettings, Annotation is set to Off.

State Saved	Saved in instrument state.
Initial S/W Revision	Prior to A.02.00

## Screen

This controls the display of the annunciation and annotation around the graticule, including any annotation on lines (such as the display line, the threshold line, etc.) and the y-axis annotation. This does NOT include marker annotation (or the N dB result). When off, the graticule expands to fill the entire graticule area, leaving only the 1.5% gap above the graticule as described in the Trace/Detector chapter.

Key Path	View/Display, Display, Annotation
<b>Remote Command</b>	:DISPlay:ANNotation:SCReen[:STATe] OFF ON 0 1 :DISPlay:ANNotation:SCReen[:STATe]?
<b>Example</b>	DISP:ANN:SCR OFF
Dependencies	Grayed-out and forced to OFF when System Display Settings, Annotation is set to Off.
Preset	On This should remain Off through a Preset when System DisplaySettings, Annotation is set to Off
State Saved	Saved in instrument state.
Initial S/W Revision	Prior to A.02.00

## Active Function Values On/Off

Turns on and off the active function display in the Meas Bar, and all of the active function values displayed on the softkeys.

Note that all of the softkeys that have active functions have these numeric values blanked when this function is on. This is a security feature..

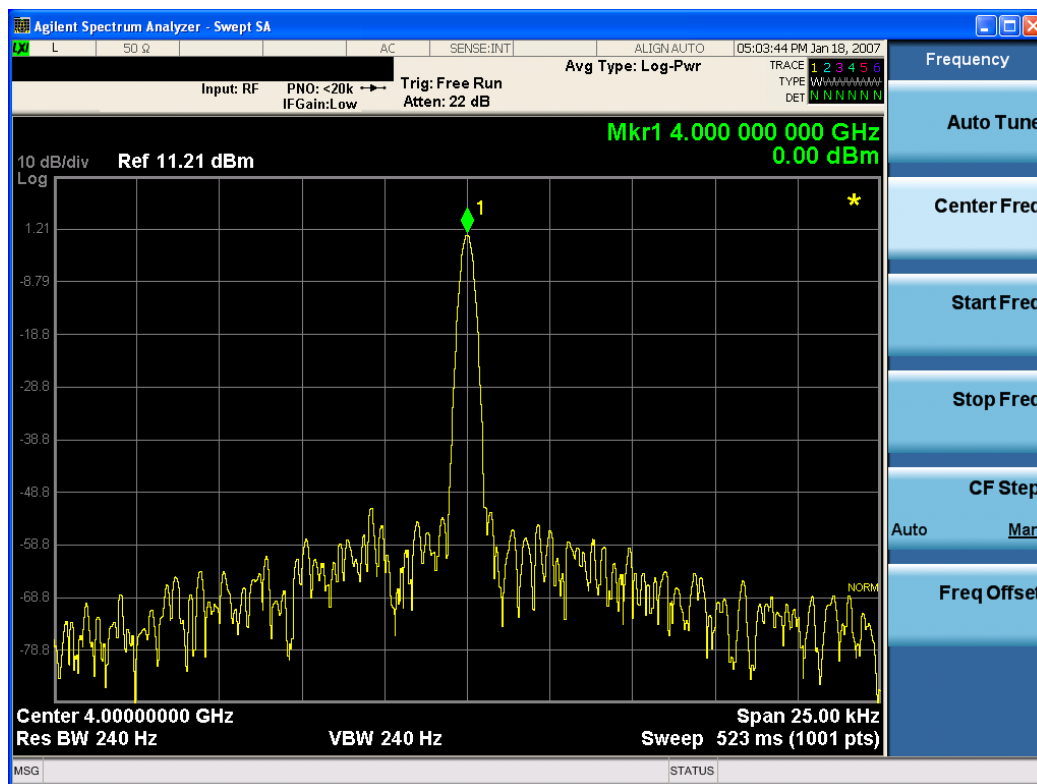

Key Path	View/Display, Display, Annotation
Remote Command	:DISPlay:ACTivefunc[:STATE] ON OFF 1 0 :DISPlay:ACTivefunc[:STATE]?
Example	DISP:ACT OFF
Dependencies	Grayed out and forced to OFF when System Display Settings, Annotation is set to Off.
Preset	On This should remain Off through a Preset when System DisplaySettings, Annotation is set to Off
State Saved	Saved in instrument state.
Initial S/W Revision	Prior to A.02.00

## Title

Displays menu keys that enable you to change or clear a title on your display.

Key Path	View/Display, Display
Initial S/W Revision	Prior to A.02.00

## Change Title

Writes a title into the "measurement name" field in the banner, for example, "Swept SA".

Press Change Title to enter a new title through the alpha editor. Press Enter or Return to complete the entry. Press ESC to cancel the entry and preserve your existing title.

The display title will replace the measurement name. It remains for this measurement until you press Change Title again, or you recall a state, or a Preset is performed. A title can also be cleared by pressing Title, Clear Title.

**NOTE**

Notice the inclusion of the <measurement> parameter in the command below. Because each measurement remembers the Display Title, the command must be qualified with the measurement name. For the Swept SA measurement this is not the case; no <measurement> parameter is used when changing the Display Title for the Swept SA measurement.

Key Path	View/Display, Display, Title
Mode	All
Remote Command	:DISPlay:<measurement>:ANNotation:TITLe:DATA <string> :DISPlay:<measurement>:ANNotation:TITLe:DATA?
Example	DISP:ANN:TITL:DATA "This Is My Title" This example is for the Swept SA measurement in the Spectrum Analyzer mode. The SANalyzer <measurement> name is not used. DISP:ACP:ANN:TITL:DATA "This Is My Title" This example is for Measurements other than Swept SA. Both set the title to: This Is My Title
Notes	Pressing this key cancels any active function. When a title is edited the previous title remains intact (it is not cleared) and the cursor goes at the end so that characters can be added or BKSP can be used to go back over previous characters.
Preset	No title (measurement name instead)
State Saved	Saved in instrument state.
Initial S/W Revision	Prior to A.02.00

### Clear Title

Clears a title from the front-panel display. Once cleared, the title cannot be retrieved. After the title is cleared, the current Measurement Name replaces it in the title bar.

Key Path	View/Display, Display, Title
Example	The following commands clear the title and restore the measurement's original title: DISP:ANN:TITL:DATA "" This example is for the Swept SA measurement in the Spectrum Analyzer mode. The SANalyzer <measurement> name is not used. DISP:ACP:ANN:TITL:DATA "" This example is for ACP; in measurements other than Swept SA the measurement name is required.
Notes	Uses the :DISPlay:<measurement>:ANNotation:TITLe:DATA <string> command with an empty string (in the Swept SA, the <measurement> is omitted).



Preset	Performed on Preset.
Initial S/W Revision	Prior to A.02.00

## Graticule

Pressing Graticule turns the display graticule On or Off. It also turns the graticule y-axis annotation on and off.

Key Path	View/Display, Display
<b>Remote Command</b>	:DISPlay:WINDow[1]:TRACe:GRATicule:GRID[:STATe] OFF ON 0 1 :DISPlay:WINDow[1]:TRACe:GRATicule:GRID[:STATe]?
<b>Example</b>	DISP:WIND:TRAC:GRAT:GRID OFF
Notes	The graticule is the set of horizontal and vertical lines that make up the grid/divisions for the x-axis and y-axis.
Preset	On
State Saved	Saved in instrument state
Initial S/W Revision	Prior to A.02.00

## System Display Settings

These settings are "Mode Global" – they affect all modes and measurements and are reset only by Restore Misc Defaults or Restore System Defaults under System.

Key Path	View/Display, Display
Initial S/W Revision	Prior to A.02.00

## Annotation Local Settings

This is a Mode Global override of the meas local annotation settings. When it is All Off, it forces ScreenAnnotation, Meas Bar, Trace, and Active Function Values settings to be OFF for all measurements in all modes. This provides the security based "annotation off" function of previous analyzers; hence it uses the legacy SCPI command.

When it is All Off, the Screen, Meas Bar, Trace, and Active Function Values keys under the Display, Annotation menu are grayed out and forced to Off. When Local Settings is selected, you are able to set the local annotation settings on a measurement by measurement basis.

Key Path	View/Display, Display, System Display Settings
<b>Remote Command</b>	:DISPlay:WINDow[1]:ANNOtation[:ALL] OFF ON 0 1 :DISPlay:WINDow[1]:ANNOtation[:ALL]?
<b>Example</b>	:DISP:WIND:ANN OFF

Preset	On (Set by Restore Misc Defaults)
State Saved	Not saved in instrument state.
Backwards Compatibility Notes	The WINDow parameter and optional subopcode is included for backwards compatibility but ignored - all windows are equally affected.
Initial S/W Revision	Prior to A.02.00

## Themes

Accesses a menu of functions that enable you to choose the theme to be used when saving the screen image.

The **Themes** option is the same as the **Themes** option under the **Display** and **Page Setup** dialogs. It allows you to choose between themes to be used when saving the screen image.

Key Path	Save, Screen Image
<b>Remote Command</b>	:MMEMory:STORe:SCReen:THEMe TDColor   TDMonochrome   FCOLor   FMONochrome  :MMEMory:STORe:SCReen:THEMe?
<b>Example</b>	:MMEM:STOR:SCR:THEM TDM
Preset	3D Color; Is not part of Preset, but is reset by Restore Misc Defaults or Restore System Defaults All and survives subsequent running of the modes.
Readback	3D Color   3D Mono   Flat Color   Flat Mono
Backwards Compatibility Notes	In ESA and PSA we offer the choice of "Reverse Bitmap" or "Reverse Metafile" when saving screen images. This is much like the "Flat Color" theme available in X-Series. Also, if you selected Reverse Bitmap AND a black & white screen image, that would be much like "Flat Monochrome". In other words, each of the X-Series themes has a similar screen image type in ESA/PSA. But they are not identical.
Initial S/W Revision	Prior to A.02.00

## 3D Color

Selects a standard color theme with each object filled, shaded and colored as designed.

Key Path	Save, Screen Image, Themes
<b>Example</b>	MMEM:STOR:SCR:THEM TDC
Readback	3D Color
Initial S/W Revision	Prior to A.02.00

## 3D Monochrome

Selects a format that is like 3D color but shades of gray are used instead of colors.

Key Path	Save, Screen Image, Themes
<b>Example</b>	MMEM:STOR:SCR:THEM TDM
Readback	3D Mono
Initial S/W Revision	Prior to A.02.00

### Flat Color

Selects a format that is best when the screen is to be printed on an ink printer.

Key Path	Save, Screen Image, Themes
<b>Example</b>	MMEM:STOR:SCR:THEM FCOL
Readback	Flat Color
Initial S/W Revision	Prior to A.02.00

### Flat Monochrome

Selects a format that is like Flat Color. But only black is used (no colors, not even gray), and no fill.

Key Path	Save, Screen Image, Themes
<b>Example</b>	MMEM:STOR:SCR:THEM FMON
Readback	Flat Mono
Initial S/W Revision	Prior to A.02.00

### Bar Graph

Turns the Bar Graph On and Off.

Key Path	View/Display
Mode	SA, WCDMA, C2K, WIMAX OFDMA, TD-SCDMA, 1xEVDO, DVB-T/H, DTMB (CTTB), ISDB-T, CMMB, LTE, LTE-TDD, Digital Cable TV, MSR, LTEAFDD, LTEATDD
<b>Remote Command</b>	:DISPlay:ACPower:VIEW[1]:WINDow[1]:BGRaph OFF ON 0 1 :DISPlay:ACPower:VIEW[1]:WINDow[1]:BGRaph?
<b>Example</b>	DISP:ACP:VIEW:WIND:BGR OFF DISP:ACP:VIEW:WIND:BGR?
Notes	You must be in the mode that includes ACP measurements to use this command. Use :INSTrument:SElect to set the mode.
Dependencies	When the method is RBW, this key is always set to On and grayed out.
Preset	ON
State Saved	Saved in instrument state.

Range	On Off
Initial S/W Revision	Prior to A.02.00
Modified at S/W Revision	A.02.00, A.03.00

## 10 Spectrum Emission Mask Measurement

The spectrum emission mask measures spurious signal levels in up to six pairs of offset frequencies and relates them to the carrier power. For measurement results and views, see ["View/Display" on page 1195](#).

This topic contains the following sections:

["Measurement Commands for Spectrum Emission Mask" on page 882](#)

["Remote Command Results for Spectrum Emission Mask Measurement" on page 883](#)

["Number of Offsets" on page 903](#)

## Measurement Commands for Spectrum Emission Mask

Offsets that are turned off (inactive) return -999.0 when their results are queried via SCPI.

```
:CONFigure:SEMask  
:CONFigure:SEMask:NDEFault  
:INITiate:SEMask  
:FETCh:SEMask[n]?  
:MEASure:SEMask[n]?  
:READ:SEMask[n]?
```

For more measurement related commands, see the SENSE subsystem, and the section Remote Measurement Functions@29978.

## Remote Command Results for Spectrum Emission Mask Measurement

The following table describes the results returned by the FETCh, MEASure, and READ queries listed above, according to the index value n:

Modes	n	Return Value
All except MSR, WLAN, LTEAFDD, LTEATDD	1	<p><b>Meas Type: Total Power Reference</b></p> <p>Returns 82 comma-separated scalar results, in the following order:</p> <ol style="list-style-type: none"> <li>1. Reserved for the future use, returns -999.0</li> <li>2. Absolute power at the center frequency (reference) area (dBm)</li> <li>3. Reserved for the future use, returns -999.0</li> <li>4. Reserved for the future use, returns -999.0</li> <li>5. Peak frequency in the center frequency (reference) area (Hz)</li> <li>6. Reserved for the future use, returns -999.0</li> <li>7. Reserved for the future use, returns -999.0</li> <li>8. Reserved for the future use, returns -999.0</li> <li>9. Reserved for the future use, returns -999.0</li> <li>10. Reserved for the future use, returns -999.0</li> <li>11. Relative integrated power on the negative offset A (dBc)</li> <li>12. Absolute integrated power on the negative offset A (dBm)</li> <li>13. Relative peak power on the negative offset A (dBc)</li> <li>14. Absolute peak power on the negative offset A (dBm)</li> <li>15. Peak power offset frequency from the center or carrier edge frequency in the negative offset A, depending on Offset Frequency Define settings (Hz)</li> <li>16. Relative integrated power on the positive offset A (dBc)</li> <li>17. Absolute integrated power on the positive offset A (dBm)</li> <li>18. Relative peak power on the positive offset A (dBc)</li> <li>19. Absolute peak power on the positive offset A (dBm)</li> <li>20. Peak power offset frequency from the center or carrier edge frequency in the positive offset A, depending on Offset Frequency Define settings (Hz)</li> <li>21. Relative integrated power on the negative offset B (dBc)</li> <li>---</li> <li>69. Absolute peak power on the positive offset F (dBm)</li> <li>70. Peak power offset frequency from the center or carrier edge frequency in the positive offset F, depending on Offset Frequency Define settings (Hz)</li> <li>71. Minimum margin from limit line on the negative offset A (dB)</li> <li>72. Minimum margin from limit line on the positive offset A (dB)</li> <li>73. Minimum margin from limit line on the negative offset B (dB)</li> <li>74. Minimum margin from limit line on the positive offset B (dB)</li> <li>75. Minimum margin from limit line on the negative offset C (dB)</li> <li>76. Minimum margin from limit line on the positive offset C (dB)</li> </ol>

Modes	n	Return Value
		77. Minimum margin from limit line on the negative offset D (dB) 78. Minimum margin from limit line on the positive offset D (dB) 79. Minimum margin from limit line on the negative offset E (dB) 80. Minimum margin from limit line on the positive offset E (dB) 81. Minimum margin from limit line on the negative offset F (dB) 82. Minimum margin from limit line on the positive offset F (dB)
All except MSR, WLAN, LTEAFDD, LTEATDD	1	<b>Meas Type: Power Spectral Density Reference</b> Returns 82 comma-separated scalar results, in the following order: 1. Reserved for the future use, returns -999.0 2. Absolute power at the center frequency (reference) area (dBm/Hz) 3. Reserved for the future use, returns -999.0 4. Reserved for the future use, returns -999.0 5. Peak frequency in the center frequency (reference) area (Hz) 6. Reserved for the future use, returns -999.0 7. Reserved for the future use, returns -999.0 8. Reserved for the future use, returns -999.0 9. Reserved for the future use, returns -999.0 10. Reserved for the future use, returns -999.0 11. Relative integrated power on the negative offset A (dB) 12. Absolute integrated power on the negative offset A (dBm/Hz) 13. Relative peak power on the negative offset A (dB) 14. Absolute peak power on the negative offset A (dBm/Hz) 15. Peak power offset frequency from the center or carrier edge frequency in the negative offset A, depending on Offset Frequency Define settings (Hz) 16. Relative integrated power on the positive offset A (dB) 17. Absolute integrated power on the positive offset A (dBm/Hz) 18. Relative peak power on the positive offset A (dB) 19. Absolute peak power on the positive offset A (dBm/Hz) 20. Peak power offset frequency from the center or carrier edge frequency in the positive offset A, depending on Offset Frequency Define settings (Hz) 21. Relative integrated power on the negative offset B (dB) --- 69. Absolute peak power on the positive offset F (dBm/Hz) 70. Peak power offset frequency from the center or carrier edge frequency in the positive offset F, depending on Offset Frequency Define settings (Hz) 71. Minimum margin from limit line on the negative offset A (dB) 72. Minimum margin from limit line on the positive offset A (dB) 73. Minimum margin from limit line on the negative offset B (dB) 74. Minimum margin from limit line on the positive offset B (dB)



Modes	n	Return Value
		75. Minimum margin from limit line on the negative offset C (dB)
		76. Minimum margin from limit line on the positive offset C (dB)
		77. Minimum margin from limit line on the negative offset D (dB)
		78. Minimum margin from limit line on the positive offset D (dB)
		79. Minimum margin from limit line on the negative offset E (dB)
		80. Minimum margin from limit line on the positive offset E (dB)
		81. Minimum margin from limit line on the negative offset F (dB)
		82. Minimum margin from limit line on the positive offset F (dB)
All except MSR, WLAN, LTEAFDD, LTEATDD	1	<p><b>Meas Type: Spectrum Peak Reference</b> Returns 82 comma-separated scalar results, in the following order:</p> <ol style="list-style-type: none"> <li>1. Reserved for the future use, returns -999.0</li> <li>2. Peak power at the center frequency (reference) area (dBm)</li> <li>3. Reserved for the future use, returns -999.0</li> <li>4. Reserved for the future use, returns -999.0</li> <li>5. Peak frequency in the center frequency (reference) area (Hz)</li> <li>6. Reserved for the future use, returns -999.0</li> <li>7. Reserved for the future use, returns -999.0</li> <li>8. Reserved for the future use, returns -999.0</li> <li>9. Reserved for the future use, returns -999.0</li> <li>10. Reserved for the future use, returns -999.0</li> <li>11. Reserved for the future use, returns -999.0</li> <li>12. Reserved for the future use, returns -999.0</li> <li>13. Relative peak power on the negative offset A (dB)</li> <li>14. Absolute peak power on the negative offset A (dBm)</li> <li>15. Peak power offset frequency from the center or carrier edge frequency in the negative offset A, depending on Offset Frequency Define settings (Hz)</li> <li>16. Reserved for the future use, returns -999.0</li> <li>17. Reserved for the future use, returns -999.0</li> <li>18. Relative peak power on the positive offset A (dB)</li> <li>19. Absolute peak power on the positive offset A (dBm)</li> <li>20. Peak power offset frequency from the center or carrier edge frequency in the positive offset A, depending on Offset Frequency Define settings (Hz)</li> <li>21. Reserved for the future use, returns -999.0</li> <li>---</li> <li>69. Absolute peak power on the positive offset F (dBm)</li> <li>70. Peak power offset frequency from the center or carrier edge frequency in the positive offset F, depending on Offset Frequency Define settings (Hz)</li> <li>71. Minimum margin from limit line on the negative offset A (dB)</li> <li>72. Minimum margin from limit line on the positive offset A (dB)</li> </ol>

Modes	n	Return Value
		73. Minimum margin from limit line on the negative offset B (dB)
		74. Minimum margin from limit line on the positive offset B (dB)
		75. Minimum margin from limit line on the negative offset C (dB)
		76. Minimum margin from limit line on the positive offset C (dB)
		77. Minimum margin from limit line on the negative offset D (dB)
		78. Minimum margin from limit line on the positive offset D (dB)
		79. Minimum margin from limit line on the negative offset E (dB)
		80. Minimum margin from limit line on the positive offset E (dB)
		81. Minimum margin from limit line on the negative offset F (dB)
		82. Minimum margin from limit line on the positive offset F (dB)
MSR, LTEAFDD, LTEATDD	1	<p><b>Meas Type: Total Power Reference</b></p> <p>Returns outer offset results when Non-Contiguous Meas Region is set to Outer, and returns inner offset results when it is set to Inner, in the following order.</p> <ol style="list-style-type: none"> <li>1. Total Absolute power of carriers of Measure Carrier On if available. Otherwise -999.0 is returned.</li> <li>2. Absolute reference power. Absolute power at the left reference carrier if Power Ref type is "Left &amp; Right Carriers." Absolute power at the reference carrier of the left sub-block if Power Ref type is "Max Power Carrier in Sub-block." (dBm)</li> <li>3. Absolute power at the right reference carrier if Power Ref type is "Left &amp; Right Carriers." Absolute power at the reference carrier of the right sub-block if Power Ref type is "Max Power Carrier in Sub-block." Otherwise -999.0 is returned. (dBm)</li> <li>4. Reserved for the future use, returns -999.0</li> <li>5. Peak frequency in the ref carrier channel spacing frequency range. Peak frequency in the left ref carrier frequency range if Power Ref Type is "Left &amp; Right Carriers." Peak frequency in the ref carrier frequency range of the left sub-block if Power Ref type is "Max Power Carrier in Sub-block."</li> <li>6. Peak frequency in the right ref carrier channel spacing frequency range if Power Ref type is "Left &amp; Right Carriers." Peak frequency in the ref carrier frequency range of the right sub-block if Power Ref type is "Max Power Carrier in Sub-block." Otherwise -999.0 is returned.</li> <li>7. Reserved for the future use, returns -999.0</li> <li>8. Reserved for the future use, returns -999.0</li> <li>9. Reserved for the future use, returns -999.0</li> <li>10. Reserved for the future use, returns -999.0</li> <li>11. Relative integrated power on the negative offset A (dBc)</li> <li>12. Absolute integrated power on the negative offset A (dBm)</li> <li>13. Relative peak power on the negative offset A (dBc)</li> <li>14. Absolute peak power on the negative offset A (dBm)</li> <li>15. Peak power offset frequency from the center or carrier edge frequency in the negative offset A, depending on Offset Frequency Define settings (Hz)</li> <li>16. Relative integrated power on the positive offset A (dBc)</li> <li>17. Absolute integrated power on the positive offset A (dBm)</li> </ol>

Modes	n	Return Value
		18. Relative peak power on the positive offset A (dBc)
		19. Absolute peak power on the positive offset A (dBm)
		20. Peak power offset frequency from the center or carrier edge frequency in the positive offset A, depending on Offset Frequency Define settings (Hz)
		21. Relative integrated power on the negative offset B (dBc)
		---
		69. Absolute peak power on the positive offset F (dBm)
		70. Peak power offset frequency from the center or carrier edge frequency in the positive offset F, depending on Offset Frequency Define settings (Hz)
		71. Minimum margin from limit line on the negative offset A (dB)
		72. Minimum margin from limit line on the positive offset A (dB)
		73. Minimum margin from limit line on the negative offset B (dB)
		74. Minimum margin from limit line on the positive offset B (dB)
		75. Minimum margin from limit line on the negative offset C (dB)
		76. Minimum margin from limit line on the positive offset C (dB)
		77. Minimum margin from limit line on the negative offset D (dB)
		78. Minimum margin from limit line on the positive offset D (dB)
		79. Minimum margin from limit line on the negative offset E (dB)
		80. Minimum margin from limit line on the positive offset E (dB)
		81. Minimum margin from limit line on the negative offset F (dB)
		82. Minimum margin from limit line on the positive offset F (dB)
MSR , LTEAFDD, LTEATDD	1	<p><b>Meas Type: Power Spectral Density Reference</b> Returns outer offset results when Non-Contiguous Meas Region is set to Outer, and returns inner offset results when it is set to Inner, in the following order.</p> <ol style="list-style-type: none"> <li>1. Total Absolute power of carriers of Measure Carrier On if available. Otherwise -999.0 is returned. (dBm)</li> <li>2. Absolute reference power. Absolute power at the left reference carrier if Power Ref type is "Left &amp; Right Carriers." Absolute power at the reference carrier of the left sub-block if Power Ref type is "Max Power Carrier in Sub-block." (dBm/Hz)</li> <li>3. Absolute power at the right reference carrier if Power Ref type is "Left &amp; Right Carriers." Absolute power at the reference carrier of the right sub-block if Power Ref type is "Max Power Carrier in Sub-block." Otherwise -999.0 is returned. (dBm/Hz)</li> <li>4. Reserved for the future use, returns -999.0</li> <li>5. Peak frequency in the ref carrier channel spacing frequency range . Peak frequency in the left ref carrier frequency range if Power Ref type is "Left &amp; Right Carriers." Peak frequency in the ref carrier frequency range of the left sub-block if Power Ref type is "Max Power Carrier in Sub-block."</li> <li>6. Peak frequency in the right ref carrier channel spacing frequency range if Power Ref type is "Left &amp; Right Carriers." Peak frequency in the ref carrier frequency range of the right sub-block if Power Ref type is "Max Power Carrier in Sub-block." Otherwise -999.0 is returned.</li> <li>7. Reserved for the future use, returns -999.0</li> </ol>

Modes	n	Return Value
		8. Reserved for the future use, returns -999.0
		9. Reserved for the future use, returns -999.0
		10. Reserved for the future use, returns -999.0
		11. Relative integrated power on the negative offset A (dBc)
		12. Absolute integrated power on the negative offset A (dBm/Hz)
		13. Relative peak power on the negative offset A (dBc)
		14. Absolute peak power on the negative offset A (dBm/Hz)
		15. Peak power offset frequency from the center or carrier edge frequency in the negative offset A, depending on Offset Frequency Define settings (Hz)
		16. Relative integrated power on the positive offset A (dBc)
		17. Absolute integrated power on the positive offset A (dBm/Hz)
		18. Relative peak power on the positive offset A (dBc)
		19. Absolute peak power on the positive offset A (dBm/Hz)
		20. Peak power offset frequency from the center or carrier edge frequency in the positive offset A, depending on Offset Frequency Define settings (Hz)
		21. Relative integrated power on the negative offset B (dBc)
		---
		69. Absolute peak power on the positive offset F (dBm/Hz)
		70. Peak power offset frequency from the center or carrier edge frequency in the positive offset F, depending on Offset Frequency Define settings (Hz)
		71. Minimum margin from limit line on the negative offset A (dB)
		72. Minimum margin from limit line on the positive offset A (dB)
		73. Minimum margin from limit line on the negative offset B (dB)
		74. Minimum margin from limit line on the positive offset B (dB)
		75. Minimum margin from limit line on the negative offset C (dB)
		76. Minimum margin from limit line on the positive offset C (dB)
		77. Minimum margin from limit line on the negative offset D (dB)
		78. Minimum margin from limit line on the positive offset D (dB)
		79. Minimum margin from limit line on the negative offset E (dB)
		80. Minimum margin from limit line on the positive offset E (dB)
		81. Minimum margin from limit line on the negative offset F (dB)
		82. Minimum margin from limit line on the positive offset F (dB)
MSR, LTEAFDD, LTEATDD	1	<p><b>Meas Type: Spectrum Peak Reference</b></p> <p>Returns outer offset results when Non-Contiguous Meas Region is set to Outer, and returns inner offset results when it is set to Inner, in the following order.</p> <ol style="list-style-type: none"> <li>1. Total Absolute power of carriers of Measure Carrier On if available. Otherwise -999.0 is returned. (dBm)</li> <li>2. Peak reference power. Peak power at the left reference carrier if Power Ref type is "Left &amp; Right Carriers." Peak power at the reference carrier of the left sub-block if Power Ref type is "Max Power Carrier in Sub-block." (dBm)</li> </ol>

Modes	n	Return Value
		3. Peak power at the right reference carrier if Power Ref type is "Left & Right Carriers." Peak power at the reference carrier of the right sub-block if Power Ref type is "Max Power Carrier in Sub-block." Otherwise -999.0 is returned. (dBm)
		4. Reserved for the future use, returns -999.0
		5. Peak frequency in the ref carrier channel spacing frequency range. Peak frequency in the left ref carrier frequency range if Power Ref type is "Left & Right Carriers." Peak frequency in the ref carrier frequency range of the left sub-block if Power Ref type is "Max Power Carrier in Sub-block."
		6. Peak frequency in the right ref carrier channel spacing frequency range if Power Ref type is "Left & Right Carriers." Peak frequency in the ref carrier frequency range of the right sub-block if Power Ref type is "Max Power Carrier in Sub-block." Otherwise -999.0 is returned.
		7. Reserved for the future use, returns -999.0
		8. Reserved for the future use, returns -999.0
		9. Reserved for the future use, returns -999.0
		10. Reserved for the future use, returns -999.0
		11. Relative integrated power on the negative offset A (dBc)
		12. Absolute integrated power on the negative offset A (dBm)
		13. Relative peak power on the negative offset A (dBc)
		14. Absolute peak power on the negative offset A (dBm)
		15. Peak power offset frequency from the center or carrier edge frequency in the negative offset A, depending on Offset Frequency Define settings (Hz)
		16. Relative integrated power on the positive offset A (dBc)
		17. Absolute integrated power on the positive offset A (dBm)
		18. Relative peak power on the positive offset A (dBc)
		19. Absolute peak power on the positive offset A (dBm)
		20. Peak power offset frequency from the center or carrier edge frequency in the positive offset A, depending on Offset Frequency Define settings (Hz)
		21. Relative integrated power on the negative offset B (dBc)
		---
		69. Absolute peak power on the positive offset F (dBm)
		70. Peak power offset frequency from the center or carrier edge frequency in the positive offset F, depending on Offset Frequency Define settings (Hz)
		71. Minimum margin from limit line on the negative offset A (dB)
		72. Minimum margin from limit line on the positive offset A (dB)
		73. Minimum margin from limit line on the negative offset B (dB)
		74. Minimum margin from limit line on the positive offset B (dB)
		75. Minimum margin from limit line on the negative offset C (dB)
		76. Minimum margin from limit line on the positive offset C (dB)
		77. Minimum margin from limit line on the negative offset D (dB)
		78. Minimum margin from limit line on the positive offset D (dB)
		79. Minimum margin from limit line on the negative offset E (dB)
		80. Minimum margin from limit line on the positive offset E (dB)

Modes	n	Return Value
		81. Minimum margin from limit line on the negative offset F (dB)
		82. Minimum margin from limit line on the positive offset F (dB)
WLAN, with radio standard 802.11 ac (80 MHz + 80 MHz)	1	<p><b>Meas Type: Total Power Reference</b></p> <p>Returns 82 comma-separated scalar results, in the following order:</p> <ol style="list-style-type: none"> <li>1. Reserved for the future use, returns -999.0</li> <li>2. Absolute reference power (dBm)</li> <li>3. Absolute power of the carrier of which the frequency is indicated by Freq Segment 1 (dBm)</li> <li>4. Absolute power of the carrier of which the frequency is indicated by Freq Segment 2 (dBm)</li> <li>5. Peak frequency in the center frequency (reference) area (Hz)</li> <li>6. Reserved for the future use, returns -999.0</li> <li>7. Reserved for the future use, returns -999.0</li> <li>8. Reserved for the future use, returns -999.0</li> <li>9. Reserved for the future use, returns -999.0</li> <li>10. Reserved for the future use, returns -999.0</li> <li>11. Relative integrated power on the negative offset A (dBc)</li> <li>12. Absolute integrated power on the negative offset A (dBm)</li> <li>13. Relative peak power on the negative offset A (dBc)</li> <li>14. Absolute peak power on the negative offset A (dBm)</li> <li>15. Peak power offset frequency from the center or carrier edge frequency in the negative offset A, depending on Offset Frequency Define settings (Hz)</li> <li>16. Relative integrated power on the positive offset A (dBc)</li> <li>17. Absolute integrated power on the positive offset A (dBm)</li> <li>18. Relative peak power on the positive offset A (dBc)</li> <li>19. Absolute peak power on the positive offset A (dBm)</li> <li>20. Peak power offset frequency from the center or carrier edge frequency in the positive offset A, depending on Offset Frequency Define settings (Hz)</li> <li>21. Relative integrated power on the negative offset B (dBc)</li> </ol> <p>---</p> <ol style="list-style-type: none"> <li>69. Absolute peak power on the positive offset F (dBm)</li> <li>70. Peak power offset frequency from the center or carrier edge frequency in the positive offset F, depending on Offset Frequency Define settings (Hz)</li> <li>71. Minimum margin from limit line on the negative offset A (dB)</li> <li>72. Minimum margin from limit line on the positive offset A (dB)</li> <li>73. Minimum margin from limit line on the negative offset B (dB)</li> <li>74. Minimum margin from limit line on the positive offset B (dB)</li> <li>75. Minimum margin from limit line on the negative offset C (dB)</li> <li>76. Minimum margin from limit line on the positive offset C (dB)</li> <li>77. Minimum margin from limit line on the negative offset D (dB)</li> <li>78. Minimum margin from limit line on the positive offset D (dB)</li> </ol>

Modes	n	Return Value
		79. Minimum margin from limit line on the negative offset E (dB)
		80. Minimum margin from limit line on the positive offset E (dB)
		81. Minimum margin from limit line on the negative offset F (dB)
		82. Minimum margin from limit line on the positive offset F (dB)
WLAN, with radio standard 802.11 ac (80 MHz + 80 MHz)	1	<p><b>Meas Type: Power Spectral Density Reference</b> Returns 82 comma-separated scalar results, in the following order:</p> <ol style="list-style-type: none"> <li>1. Reserved for the future use, returns -999.0</li> <li>2. Absolute reference power (dBm/Hz)</li> <li>3. Absolute power of the carrier of which the frequency is indicated by Freq Segment 1 (dBm/Hz)</li> <li>4. Absolute power of the carrier of which the frequency is indicated by Freq Segment 2 (dBm/Hz)</li> <li>5. Peak frequency in the center frequency (reference) area (Hz)</li> <li>6. Reserved for the future use, returns -999.0</li> <li>7. Reserved for the future use, returns -999.0</li> <li>8. Reserved for the future use, returns -999.0</li> <li>9. Reserved for the future use, returns -999.0</li> <li>10. Reserved for the future use, returns -999.0</li> <li>11. Relative integrated power on the negative offset A (dB)</li> <li>12. Absolute integrated power on the negative offset A (dBm/Hz)</li> <li>13. Relative peak power on the negative offset A (dB)</li> <li>14. Absolute peak power on the negative offset A (dBm/Hz)</li> <li>15. Peak power offset frequency from the center or carrier edge frequency in the negative offset A, depending on Offset Frequency Define settings (Hz)</li> <li>16. Relative integrated power on the positive offset A (dB)</li> <li>17. Absolute integrated power on the positive offset A (dBm/Hz)</li> <li>18. Relative peak power on the positive offset A (dB)</li> <li>19. Absolute peak power on the positive offset A (dBm/Hz)</li> <li>20. Peak power offset frequency from the center or carrier edge frequency in the positive offset A, depending on Offset Frequency Define settings (Hz)</li> <li>21. Relative integrated power on the negative offset B (dB)</li> <li>---</li> <li>69. Absolute peak power on the positive offset F (dBm/Hz)</li> <li>70. Peak power offset frequency from the center or carrier edge frequency in the positive offset F, depending on Offset Frequency Define settings (Hz)</li> <li>71. Minimum margin from limit line on the negative offset A (dB)</li> <li>72. Minimum margin from limit line on the positive offset A (dB)</li> <li>73. Minimum margin from limit line on the negative offset B (dB)</li> <li>74. Minimum margin from limit line on the positive offset B (dB)</li> <li>75. Minimum margin from limit line on the negative offset C (dB)</li> <li>76. Minimum margin from limit line on the positive offset C (dB)</li> </ol>

Modes	n	Return Value
		77. Minimum margin from limit line on the negative offset D (dB) 78. Minimum margin from limit line on the positive offset D (dB) 79. Minimum margin from limit line on the negative offset E (dB) 80. Minimum margin from limit line on the positive offset E (dB) 81. Minimum margin from limit line on the negative offset F (dB) 82. Minimum margin from limit line on the positive offset F (dB)
All	2	Returns the displayed frequency domain spectrum trace data separated by comma. The number of data points is 2001.
All	3	Returns the displayed frequency domain absolute limit trace data separated by comma. The number of data points is 2001.
All	4	Returns the displayed frequency domain relative limit trace data separated by comma. The number of data points is 2001.
All (see details)	5	<p><b>Meas Type: Total Power Reference</b> Returns comma-separated scalar values (in dBm) of the absolute integrated power of the segment frequencies. The length of the result depends on the number of available offset (See <a href="#">"Number of Offsets" on page 903</a>).</p> <ol style="list-style-type: none"> <li>1. Total power reference (dBm)</li> <li>2. Reserved for the future use, returns -999.0</li> <li>3. Absolute integrated power at negative offset frequency (A)</li> <li>4. Absolute integrated power at positive offset frequency (A)</li> </ol> <p>---</p> <ol style="list-style-type: none"> <li>25. Absolute integrated power at negative offset frequency (L)</li> <li>26. Absolute integrated power at positive offset frequency (L)</li> </ol> <p>In <b>MSR and LTE-Advanced FDD/TDD</b> mode. Returns outer offset results when Non-Contiguous Meas Region is set to Outer, and returns inner offset results when it is set to Inner, in the following order.</p> <ol style="list-style-type: none"> <li>1. Ref carrier power. Left ref carrier power if Power Ref type is "Left &amp; Right Carriers." Ref carrier power of the left sub-block if Power Ref type is "Max Power Carrier in Sub-block." (dBm)</li> <li>2. Right ref carrier power if Ref channel type is "Left &amp; Right Carriers." Ref carrier power of the right sub-block if Power Ref type is "Max Power Carrier in Sub-block." Otherwise -999.0 is returned. (dBm)</li> <li>3. Absolute integrated power at negative offset frequency (A)</li> <li>4. Absolute integrated power at positive offset frequency (A)</li> </ol> <p>---</p> <ol style="list-style-type: none"> <li>25. Absolute integrated power at negative offset frequency (L)</li> <li>26. Absolute integrated power at positive offset frequency (L)</li> </ol> <p>In <b>WLAN</b> mode. Returns 26 comma-separated scalar values (in dBm) of the absolute integrated power of the segment frequencies:</p> <ol style="list-style-type: none"> <li>1. Ref carrier power (dBm)</li> <li>2. Reserved for the future use, returns -999.0</li> </ol>



Modes	n	Return Value
		3. Absolute integrated power at negative offset frequency (A) 4. Absolute integrated power at positive offset frequency (A) --- 25. Absolute integrated power at negative offset frequency (L) 26. Absolute integrated power at positive offset frequency (L) If the result is not available, -999.0 is returned. The number of values returned is subject to change in future releases.
All (see details)	5	<p><b>Meas Type: Power Spectral Density Reference</b>            Returns comma-separated scalar values (in dBm/Hz) of the absolute integrated power of the segment frequencies. The length of the result depends on the number of available offset (See <a href="#">"Number of Offsets" on page 903</a>).</p> 1. Power spectral density reference (dBm/Hz) 2. Reserved for the future use, returns -999.0 3. Absolute integrated power at negative offset frequency (A) 4. Absolute integrated power at positive offset frequency (A) --- 25. Absolute integrated power at negative offset frequency (L) 26. Absolute integrated power at positive offset frequency (L) <b>In MSR and LTE-Advanced FDD/TDD mode.</b> Returns outer offset results when Non-Contiguous Meas Region is set to Outer, and returns inner offset results when it is set to Inner, in the following order. 1. Ref carrier power. Left ref carrier power if Power Ref type is "Left & Right Carriers" Ref carrier power of the left sub-block if Power Ref type is "Max Power Carrier in Sub-block." (dBm/Hz) 2. Right ref carrier power if Power Ref type is "Left & Right Carriers." Ref carrier power of the right sub-block if Power Ref type is "Max Power Carrier in Sub-block." Otherwise -999.0 is returned. (dBm/Hz) 3. Absolute integrated power at negative offset frequency (A) 4. Absolute integrated power at positive offset frequency (A) --- 25. Absolute integrated power at negative offset frequency (L) 26. Absolute integrated power at positive offset frequency (L) <b>In WLAN mode.</b> Returns 26 comma-separated scalar values (in dBm/Hz) of the absolute integrated power of the segment frequencies: 1. Ref carrier power (dBm/Hz) 2. Reserved for the future use, returns -999.0 3. Absolute integrated power at negative offset frequency (A) 4. Absolute integrated power at positive offset frequency (A) --- 25. Absolute integrated power at negative offset frequency (L)

Modes	n	Return Value
		<p>26. Absolute integrated power at positive offset frequency (L)</p> <p>If the result is not available, -999.0 is returned.</p> <p>The number of values returned is subject to change in future releases.</p>
All (see details)	5	<p><b>Meas Type: Spectrum Peak Reference</b></p> <p>Returns comma-separated scalar values (in dBm) of the absolute peak power of the segment frequencies. The length of the result depends on the number of available offset (See "<a href="#">Number of Offsets</a>" on page 903).</p> <ol style="list-style-type: none"> <li>1. Spectrum Peak Power reference (dBm)</li> <li>2. Reserved for the future use, returns -999.0</li> <li>3. Absolute peak power at negative offset frequency (A)</li> <li>4. Absolute peak power at positive offset frequency (A)</li> </ol> <p>---</p> <p>25. Absolute peak power at negative offset frequency (L)</p> <p>26. Absolute peak power at positive offset frequency (L)</p> <p>In <b>MSR and LTE-Advanced FDD/TDD</b> mode.</p> <p>Returns outer offset results when Non-Contiguous Meas Region is set to Outer, and returns inner offset results when it is set to Inner, in the following order.</p> <ol style="list-style-type: none"> <li>1. Spectrum Peak Power reference of ref carrier. Spectrum Peak Power reference of left ref carrier if Power Ref type is "Left &amp; Right Carriers." Spectrum Peak Power reference of the left sub-block if Power Ref type is "Max Power Carrier in Sub-block." (dBm)</li> <li>2. Spectrum Peak Power reference of right ref carrier power if Power Ref type is "Left &amp; Right carriers." Spectrum Peak Power reference of the right sub-block if Power Ref type is "Max Power Carrier in Sub-block." Otherwise -999.0 is returned. (dBm)</li> <li>3. Absolute peak power at negative offset frequency (A)</li> <li>4. Absolute peak power at positive offset frequency (A)</li> </ol> <p>---</p> <p>25. Absolute peak power at negative offset frequency (L)</p> <p>26. Absolute peak power at positive offset frequency (L)</p> <p>If the result is not available, -999.0 is returned.</p> <p>The number of values returned is subject to change in future releases.</p>
All	6	<p><b>Meas Type: Total Power Reference</b></p> <p>Returns comma-separated scalar values (in dBc) of the integrated power relative to the carrier at the segment frequencies. The length of the result depends on the number of available offset (See "<a href="#">Number of Offsets</a>" on page 903).</p> <p>When in the MSR and LTE-Advanced FDD/TDD mode, returns outer offset results when Non-Contiguous Meas Region is set to Outer, and returns inner offset results when it is set to Inner, in the following order.</p> <ol style="list-style-type: none"> <li>1. Reserved for the future use, returns -999.0</li> <li>2. Reserved for the future use, returns -999.0</li> <li>3. Relative integrated power at negative offset frequency (A)</li> </ol>

Modes	n	Return Value
		<p>4. Relative integrated power at positive offset frequency (A)</p> <p>---</p> <p>25. Relative integrated power at negative offset frequency (L)</p> <p>26. Relative integrated power at positive offset frequency (L)</p> <p>If the result is not available, -999.0 is returned.</p> <p>The number of values returned is subject to change in future releases.</p>
All	6	<p><b>Meas Type: Power Spectral Density Reference</b></p> <p>Returns comma-separated scalar values (in dBc/Hz) of the integrated power relative to the carrier at the segment frequencies. The length of the result depends on the number of available offset (See "<a href="#">Number of Offsets</a>" on page 903).</p> <p>When in the MSR and LTE-Advanced FDD/TDD mode, returns outer offset results when Non-Contiguous Meas Region is set to Outer, and returns inner offset results when it is set to Inner, in the following order.</p> <p>Returns -999.0 for the offsets if in WLAN:</p> <ol style="list-style-type: none"> <li>1. Reserved for the future use, returns -999.0</li> <li>2. Reserved for the future use, returns -999.0</li> <li>3. Relative integrated power at negative offset frequency (A)</li> <li>4. Relative integrated power at positive offset frequency (A)</li> </ol> <p>---</p> <p>25. Relative integrated power at negative offset frequency (L)</p> <p>26. Relative integrated power at positive offset frequency (L)</p> <p>If the result is not available, -999.0 is returned.</p> <p>The number of values returned is subject to change in future releases.</p>
All	6	<p><b>Meas Type: Spectrum Peak Reference</b></p> <p>Returns comma-separated scalar values (in dB) of the integrated power relative to the carrier at the segment frequencies. The length of the result depends on the number of available offset (See "<a href="#">Number of Offsets</a>" on page 903).</p> <p>When in the MSR and LTE-Advanced FDD/TDD mode, returns outer offset results when Non-Contiguous Meas Region is set to Outer, and returns inner offset results when it is set to Inner, in the following order.</p> <ol style="list-style-type: none"> <li>1. Reserved for the future use, returns -999.0</li> <li>2. Reserved for the future use, returns -999.0</li> <li>3. Relative peak power at negative offset frequency (A)</li> <li>4. Relative peak power at positive offset frequency (A)</li> </ol> <p>---</p> <p>25. Relative peak power at negative offset frequency (L)</p> <p>26. Relative peak power at positive offset frequency (L)</p> <p>If the result is not available, -999.0 is returned.</p> <p>The number of values returned is subject to change in future releases.</p>
All	7	

Modes	n	Return Value
		<p>Returns comma-separated pass/fail test results (0=passed, or 1=failed) determined by testing the minimum margin point from the limit line that is determined each offset's Limits setting. The length of the result depends on the number of available offset (See "Number of Offsets" on page 903).</p> <p>When in the MSR and LTE-Advanced FDD/TDD mode, returns outer offset results when Non-Contiguous Meas Region is set to Outer, and returns inner offset results when it is set to Inner, in the following order.</p> <ol style="list-style-type: none"> <li>1. Reserved for the future use, returns -999.0</li> <li>2. Reserved for the future use, returns -999.0</li> <li>3. At negative offset frequency (A)</li> <li>4. At positive offset frequency (A)</li> <li>---</li> <li>25. At negative offset frequency (L)</li> <li>26. At positive offset frequency (L)</li> </ol> <p>The number of values returned is subject to change in future releases.</p>
All	8	<p>Offset Pass/Fail.</p> <p>Returns comma-separated pass/fail test results (0=passed, or 1=failed) determined by testing the minimum margin point from the limit line that is determined each offset's Limits setting. The length of the result depends on the number of available offset (See "Number of Offsets" on page 903).</p> <p>When in the MSR and LTE-Advanced FDD/TDD mode, returns outer offset results when Non-Contiguous Meas Region is set to Outer, and returns inner offset results when it is set to Inner, in the following order.</p> <p>Note: These results (n=8) are the same as n=7 result.</p> <ol style="list-style-type: none"> <li>1. Reserved for the future use, returns -999.0</li> <li>2. Reserved for the future use, returns -999.0</li> <li>3. At negative offset frequency (A)</li> <li>4. At positive offset frequency (A)</li> <li>---</li> <li>25. At negative offset frequency (L)</li> <li>26. At positive offset frequency (L)</li> </ol> <p>The number of values returned is subject to change in future releases.</p>
All	9	<p>Offset Peak Power Freq.</p> <p>Returns comma-separated scalar values of frequency (in Hz) that have peak power from center or carrier edge frequency in each offset, depending on Offset Frequency Define settings. The length of the result depends on the number of available offset (See "Number of Offsets" on page 903).</p> <p>When in the MSR and LTE-Advanced FDD/TDD mode, returns outer offset results when Non-Contiguous Meas Region is set to Outer, and returns inner offset results when it is set to Inner, in the following order.</p> <ol style="list-style-type: none"> <li>1. Reserved for the future use, returns -999.0</li> <li>2. Reserved for the future use, returns -999.0</li> <li>3. Negative offset frequency (A)</li> </ol>

Modes	n	Return Value
		<p>4. Positive offset frequency (A)</p> <p>---</p> <p>25. Negative offset frequency (L)</p> <p>26. Positive offset frequency (L)</p> <p>If the result is not available, -999.0 is returned.</p> <p>The number of values returned is subject to change in future releases.</p>
All	10	<p>Offset Abs Peak Power.</p> <p>Returns comma-separated scalar values (in dBm) of the absolute peak power of the segment frequencies. The length of the result depends on the number of available offset (See "<a href="#">Number of Offsets</a>" on page 903).</p> <p>When in the MSR and LTE-Advanced FDD/TDD mode, returns outer offset results when Non-Contiguous Meas Region is set to Outer, and returns inner offset results when it is set to Inner, in the following order.</p> <ol style="list-style-type: none"> <li>1. Reserved for the future use, returns -999.0</li> <li>2. Reserved for the future use, returns -999.0</li> <li>3. At negative offset frequency (A)</li> <li>4. At positive offset frequency (A)</li> </ol> <p>---</p> <ol style="list-style-type: none"> <li>25. At negative offset frequency (L)</li> <li>26. At positive offset frequency (L)</li> </ol> <p>If the result is not available, -999.0 is returned.</p> <p>The number of values returned is subject to change in future releases.</p>
All	11	<p>Offset Rel Peak Power.</p> <p>Returns comma-separated scalar values in dBc (dB if MeasType = PSD) of the peak power relative to the carrier at the segment frequencies. The length of the result depends on the number of available offset (See "<a href="#">Number of Offsets</a>" on page 903).</p> <p>When in the MSR and LTE-Advanced FDD/TDD mode, returns outer offset results when Non-Contiguous Meas Region is set to Outer, and returns inner offset results when it is set to Inner, in the following order.</p> <ol style="list-style-type: none"> <li>1. Reserved for the future use, returns -999.0</li> <li>2. Reserved for the future use, returns -999.0</li> <li>3. At negative offset frequency (A)</li> <li>4. At positive offset frequency (A)</li> </ol> <p>---</p> <ol style="list-style-type: none"> <li>25. At negative offset frequency (L)</li> <li>26. At positive offset frequency (L)</li> </ol> <p>If the result is not available, -999.0 is returned.</p> <p>The number of values returned is subject to change in future releases.</p>
All	12	<p>Returns the power result (the peak power of the signal in the ref channel) when Meas Type is Spectrum Peak reference. Otherwise, the value returned will be -999.0.</p> <p>When in the MSR and LTE-Advanced FDD/TDD mode, returns outer offset results when Non-</p>

Modes	n	Return Value
		Contiguous Meas Region is set to Outer, and returns inner offset results when it is set to Inner, in the following order.
MSR, LTEAFDD, LTEATDD only	13	<p><b>Meas Type: Total Power Reference</b> Returns outer offset results when Non-Contiguous Meas Region is set to Outer, and returns inner offset results when it is set to Inner, in the following order.</p> <ol style="list-style-type: none"> <li>1. Total Absolute power of carriers of Measure Carrier On if Power Ref Type is "Max Power Carrier," "Max Power Carrier in Sub-block," or "RF Bandwidth." Otherwise NaN (9.91E+37) is returned. (dBm)</li> <li>2. Absolute reference power. Absolute power at the left reference carrier if Power Ref type is "Left &amp; Right Carriers." Absolute power at the reference carrier of the left sub-block if Power Ref type is "Max Power Carrier in Sub-block." (dBm)</li> <li>3. Absolute power at the right reference carrier if Power Ref type is "Left &amp; Right Carriers." Absolute power at the reference carrier of the right sub-block if Power Ref type is "Max Power Carrier in Sub-block." Otherwise NaN (9.91E+37) is returned. (dBm)</li> <li>4. Peak frequency in the measured ref carrier frequency range. Peak frequency in the left ref carrier frequency range if Power Ref type is "Left &amp; Right Carriers." Peak frequency in the ref carrier frequency range of the left sub-block if Power Ref type is "Max Power Carrier in Sub-block." (Hz)</li> <li>5. Peak frequency in the right ref carrier frequency range if Power Ref type is "Left &amp; Right Carriers." Peak frequency in the ref carrier frequency range of the right sub-block if Power Ref type is "Max Power Carrier in Sub-block." Otherwise NaN (9.91E+37) is returned. (Hz)</li> </ol> <p>If the result is not available, NaN (9.91E+37) is returned. The number of values returned is subject to change in future releases.</p>
MSR, LTEAFDD, LTEATDD only	13	<p><b>Meas Type: Power Spectral Density Reference</b> Returns outer offset results when Non-Contiguous Meas Region is set to Outer, and returns inner offset results when it is set to Inner, in the following order.</p> <ol style="list-style-type: none"> <li>1. Total Absolute power of carriers of Measure Carrier On if Power Ref Type is "Max Power Carrier," "Max Power Carrier in Sub-block," or "RF Bandwidth." Otherwise NaN (9.91E+37) is returned. (dBm)</li> <li>2. Absolute reference power. Absolute power at the left reference carrier if Power Ref type is "Left &amp; Right Carriers." Absolute power at the reference carrier of the left sub-block if Power Ref type is "Max Power Carrier in Sub-block." (dBm/Hz)</li> <li>3. Absolute power at the right reference carrier if Power Ref type is "Left &amp; Right Carriers." Absolute power at the reference carrier of the right sub-block if Power Ref type is "Max Power Carrier in Sub-block." Otherwise NaN (9.91E+37) is returned. (dBm/Hz)</li> <li>4. Peak frequency in the measured ref carrier frequency range. Peak frequency in the left ref carrier frequency range if Power Ref type is "Left &amp; Right Carriers." Peak frequency in the ref carrier frequency range of the left sub-block if Power Ref type is "Max Power Carrier in Sub-block." (Hz)</li> <li>5. Peak frequency in the right ref carrier frequency range if Power Ref type is "Left &amp; Right Carriers." Peak frequency in the ref carrier frequency range of the right sub-block if Power Ref</li> </ol>

Modes	n	Return Value
		<p>type is "Max Power Carrier in Sub-block." Otherwise NaN (9.91E+37) is returned. (Hz)</p> <p>If the result is not available, NaN (9.91E+37) is returned.</p> <p>The number of values returned is subject to change in future releases.</p>
MSR, LTEAFDD, LTEATDD only	13	<p><b>Meas Type: Power Spectrum Peak Reference</b></p> <p>Returns outer offset results when Non-Contiguous Meas Region is set to Outer, and returns inner offset results when it is set to Inner, in the following order.</p> <ol style="list-style-type: none"> <li>1. Total Absolute power of carriers of Measure Carrier On if Power Ref Type is "Max Power Carrier," "Max Power Carrier in Sub-block," or "RF Bandwidth." Otherwise NaN (9.91E+37) is returned. (dBm)</li> <li>2. Peak reference power. Peak power at the left reference carrier if Power Ref type is "Left &amp; Right Carriers." Peak power at the reference carrier of the left sub-block if Power Ref type is "Max Power Carrier in Sub-block." (dBm)</li> <li>3. Peak power at the right reference carrier if Power Ref type is "Left &amp; Right Carriers." Peak power at the reference carrier of the right sub-block if Power Ref type is "Max Power Carrier in Sub-block." Otherwise NaN (9.91E+37) is returned. (dBm)</li> <li>4. Peak frequency in the measured ref carrier frequency range. Peak frequency in the left ref carrier frequency range if Power Ref type is "Left &amp; Right Carriers." Peak frequency in the ref carrier frequency range of the left sub-block if Power Ref type is "Max Power Carrier in Sub-block." (Hz)</li> <li>5. Peak frequency in the right ref carrier frequency range if Power Ref type is "Left &amp; Right Carriers." Peak frequency in the ref carrier frequency range of the right sub-block if Power Ref type is "Max Power Carrier in Sub-block." Otherwise NaN (9.91E+37) is returned. (Hz)</li> </ol> <p>If the result is not available, NaN (9.91E+37) is returned.</p> <p>The number of values returned is subject to change in future releases.</p>
All	14	<p><b>Meas Type: Total Power Reference</b></p> <p>Returns comma-separated scalar results, in the following order:</p> <p>When in the MSR and LTE-Advanced FDD/TDD mode, returns outer offset results when Non-Contiguous Meas Region is set to Outer, and returns inner offset results when it is set to Inner, in the following order.</p> <ol style="list-style-type: none"> <li>1. Relative integrated power on the negative offset A (dBc)</li> <li>2. Absolute integrated power on the negative offset A (dBm)</li> <li>3. Relative peak power on the negative offset A (dBc)</li> <li>4. Absolute peak power on the negative offset A (dBm)</li> <li>5. Peak power offset frequency from the center or carrier edge frequency in the negative offset A, depending on Offset Frequency Define settings (Hz)</li> <li>6. Relative integrated power on the positive offset A (dBc)</li> <li>7. Absolute integrated power on the positive offset A (dBm)</li> <li>8. Relative peak power on the positive offset A (dBc)</li> <li>9. Absolute peak power on the positive offset A (dBm)</li> </ol>

Modes	n	Return Value
		<p>10. Peak power offset frequency from the center or carrier edge frequency in the positive offset A, depending on Offset Frequency Define settings (Hz)</p> <p>11. Relative integrated power on the negative offset B (dBc)</p> <p>---</p> <p>119. Absolute peak power on the positive offset L (dBm)</p> <p>120. Peak power offset frequency from the center or carrier edge frequency in the positive offset L, depending on Offset Frequency Define settings (Hz)</p> <p>If the result is not available, NaN (9.91 E+37) is returned.</p> <p>The length of the result depends on the number of available offset (See <a href="#">"Number of Offsets" on page 903</a>).</p> <p>The number of values returned is subject to change in future releases.</p>
All	14	<p><b>Meas Type: Power Spectral Density Reference</b></p> <p>Returns comma-separated scalar results, in the following order:</p> <p>When in the MSR and LTE-Advanced FDD/TDD mode, returns outer offset results when Non-Contiguous Meas Region is set to Outer, and returns inner offset results when it is set to Inner, in the following order.</p> <ol style="list-style-type: none"> <li>1. Relative integrated power on the negative offset A (dB)</li> <li>2. Absolute integrated power on the negative offset A (dBm/Hz)</li> <li>3. Relative peak power on the negative offset A (dB)</li> <li>4. Absolute peak power on the negative offset A (dBm/Hz)</li> <li>5. Peak power offset frequency from the center or carrier edge frequency in the negative offset A, depending on Offset Frequency Define settings (Hz)</li> <li>6. Relative integrated power on the positive offset A (dB)</li> <li>7. Absolute integrated power on the positive offset A (dBm/Hz)</li> <li>8. Relative peak power on the positive offset A (dB)</li> <li>9. Absolute peak power on the positive offset A (dBm/Hz)</li> <li>10. Peak power offset frequency from the center or carrier edge frequency in the positive offset A, depending on Offset Frequency Define settings (Hz)</li> <li>11. Relative integrated power on the negative offset B (dB)</li> </ol> <p>---</p> <p>119. Absolute peak power on the positive offset L (dBm/Hz)</p> <p>120. Peak power offset frequency from the center or carrier edge frequency in the positive offset L, depending on Offset Frequency Define settings (Hz)</p> <p>If the result is not available, NaN (9.91 E+37) is returned.</p> <p>The length of the result depends on the number of available offset (See <a href="#">"Number of Offsets" on page 903</a>).</p> <p>The number of values returned is subject to change in future releases.</p>
All	14	<p><b>Meas Type: Spectrum Peak Reference</b></p> <p>Returns comma-separated scalar results, in the following order:</p>



Modes	n	Return Value
		<p>When in the MSR and LTE-Advanced FDD/TDD mode, returns outer offset results when Non-Contiguous Meas Region is set to Outer, and returns inner offset results when it is set to Inner, in the following order.</p> <ol style="list-style-type: none"> <li>1. Reserved for the future use, returns NaN (9.91E+37)</li> <li>2. Reserved for the future use, returns NaN (9.91E+37)</li> <li>3. Relative peak power on the negative offset A (dB)</li> <li>4. Absolute peak power on the negative offset A (dBm)</li> <li>5. Peak power offset frequency from the center or carrier edge frequency in the negative offset A, depending on Offset Frequency Define settings (Hz)</li> <li>6. Reserved for the future use, returns NaN (9.91E+37)</li> <li>7. Reserved for the future use, returns NaN (9.91E+37)</li> <li>8. Relative peak power on the positive offset A (dB)</li> <li>9. Absolute peak power on the positive offset A (dBm)</li> <li>10. Peak power offset frequency from the center or carrier edge frequency in the positive offset A, depending on Offset Frequency Define settings (Hz)</li> <li>11. Relative integrated power on the negative offset B (dB)</li> </ol> <p>---</p> <ol style="list-style-type: none"> <li>119. Absolute peak power on the positive offset L (dBm)</li> <li>120. Peak power offset frequency from the center or carrier edge frequency in the positive offset L, depending on Offset Frequency Define settings (Hz)</li> </ol> <p>If the result is not available, NaN (9.91E+37) is returned.</p> <p>The length of the result depends on the number of available offset (See "<a href="#">Number of Offsets</a>" on <a href="#">page 903</a>).</p> <p>The number of values returned is subject to change in future releases.</p>
All	15	<p><b>Meas Type: Total Power Reference</b></p> <p>Returns comma-separated scalar results, in the following order:</p> <p>When in the MSR and LTE-Advanced FDD/TDD mode, returns outer offset results when Non-Contiguous Meas Region is set to Outer, and returns inner offset results when it is set to Inner, in the following order.</p> <ol style="list-style-type: none"> <li>1. Minimum margin from limit line on the negative offset A (dB)</li> <li>2. Minimum margin from limit line on the positive offset A (dB)</li> <li>3. Minimum margin from limit line on the negative offset B (dB)</li> <li>4. Minimum margin from limit line on the positive offset B (dB)</li> </ol> <p>---</p> <ol style="list-style-type: none"> <li>23. Minimum margin from limit line on the negative offset L (dB)</li> <li>24. Minimum margin from limit line on the positive offset L (dB)</li> </ol> <p>If the result is not available, NaN (9.91E+37) is returned.</p> <p>The length of the result depends on the number of available offset (See "<a href="#">Number of Offsets</a>" on <a href="#">page 903</a>).</p> <p>The number of values returned is subject to change in future releases.</p>
MSR, LTEAFDD,	16	

<b>Modes</b>	<b>n</b>	<b>Return Value</b>
LTEATDD only		Returns number of carriers comma-separated scalar results, in the following order: 1. Absolute power of carrier 1 (dBm) 2. Absolute power of carrier 2 (dBm) --- number of carriers-1. Absolute power of carrier (number of carriers)-1 (dBm) number of carriers. Absolute power of carrier (number of carriers)-1 (dBm) If Measure Carrier of the corresponding carrier is no, NaN (9.91E+37) is returned.
WLAN only	16	Returns two carriers comma-separated scalar results when the radio standard is 802.11 ac 80+80 MHz. And returns NaN otherwise. 1. Absolute power of carrier segment 1 (dBm) 2. Absolute power of carrier segment 2 (dBm)
MSR, LTEAFDD, LTEATDD only	17	Returns the displayed frequency domain combined limit trace data separated by comma. Combined trace is a mixed trace of both absolute limit trace and relative limit trace according to the fail mask condition. The number of data points is 2001.

## Number of Offsets

The number of available offsets varies depending on the mode and option as below.

<b>Mode</b>	<b>The number of available offsets</b>
MSR, LTEAFDD, LTEATDD	12 (Offset A to L)
WLAN	12 (Offset A to L)
Other modes with option N9060A-7FP	12 (Offset A to L)
Other modes without option N9060A-7FP	6 (Offset A to F)

<b>Key Path</b>	<b>Meas</b>
Initial S/W Revision	Prior to A.02.00
Modified at S/W Revision	A.11.00, A.14.00

## AMPTD Y Scale

Accesses a menu of functions that enable you to set the vertical scale parameters. The parameter values are measurement independent except all Attenuation values and Internal Preamp selections that are measurement global.

Key Path	Front-panel key
Initial S/W Revision	Prior to A.02.00

### Ref Value

Sets the value for the absolute power reference. However, since Auto Scaling defaults to On, this value is automatically determined by the measurement result. When you set a value manually, Auto Scaling automatically changes to Off.

Key Path	AMPTD Y Scale
Mode	SA, WCDMA, C2K, WIMAX OFDMA, TD-SCDMA, 1xEVDO, DTMB (CTTB), DVB-T/H, ISDB-T, CMMB, LTE, LTEFDD, Digital Cable TV, WLAN, MSR, LTEAFDD, LTEATDD
Remote Command	:DISPlay:SEMAsk:VIEW[1]:WINDow[1]:TRACe:Y[:SCALe]:RLEVel <real> :DISPlay:SEMAsk:VIEW[1]:WINDow[1]:TRACe:Y[:SCALe]:RLEVel?
Example	DISP:SEM:VIEW:WIND:TRAC:Y:RLEV 100 DISP:SEM:VIEW:WIND:TRAC:Y:RLEV?
Notes	You must be in the mode that includes SEM measurement to use this command. Use :INSTrument:SElect to set the mode.
Couplings	When the Auto Scaling is On, this value is automatically determined by the measurement result. When you set a value manually, Auto Scaling automatically changed to Off.
Preset	10.0 dBm
State Saved	Saved in instrument state.
Min	-250 dBm
Max	250 dBm
Initial S/W Revision	Prior to A.02.00
Modified at S/W Revision	A.02.00, A.03.00

### Range

The Range menu allows setting amplitude controls of the instrument.

Key Path	AMPTD Y Scale
Scope	Meas Global
Initial S/W Revision	A.12.50

## Range

Represents the amplitude of the largest sinusoidal signal that could be present within the IF without being clipped by the ADC. For signals with high peak-to-average ratios, the range may need to exceed the rms signal power by a fair amount to avoid clipping.

Key Path	Range
Mode	BASIC
<b>Remote Command</b>	<code>[ :SENSe ] :POWer [ :RF ] :RANGe &lt;real&gt;</code> <code>[ :SENSe ] :POWer [ :RF ] :RANGe?</code>
<b>Example</b>	<code>:POW:RANG 10.0</code> <code>:POW:RANG?</code>
Notes	The MIN and MAX values are affected by the External Gain parameters, and by the Center Frequency. (The hardware compensates for frequency response and alters the Range setting.)
Preset	0
State Saved	Saved in instrument state.
Min	-100
Max	100
Initial S/W Revision	A.12.50

## Adjust Range For Min Clip

Sets the combination of attenuation and gain based on the current measured signal level so that clipping will be at a minimum.

This is an "immediate action" function, that is, it executes once, when the key is pressed.

This key is grayed out in measurements that do not support this functionality.

Key Path	AMPTD Y Scale, Attenuation
<b>Remote Command</b>	<code>[ :SENSe ] :POWer [ :RF ] :RANGe:OPTimize IMMEDIATE</code>
Initial S/W Revision	Prior to A.02.00
Modified at S/W Revision	A.03.00

## Pre-Adjust for Min Clip

If this function is on, it does the adjustment described under Adjust Range For Min Clip each time a measurement restarts. Therefore, in Continuous measurement mode, it only executes before the first measurement.

Key Path	AMPTD Y Scale, Attenuation
<b>Remote Command</b>	<code>[ :SENSe ] :POWer [ :RF ] :RANGe:OPTimize:ATTenuation OFF   ON   ELEctrical   COMBined</code>

	<code>[ :SENSe ] :POWer [ :RF ] :RANGe:OPTimize:ATTenuation?</code>
Notes	This parameter is shared with old XA platform which uses AutoAtten. To keep the backward compatibility, ELECTrical and COMBined still can be used. Then, upon receiving ELECTrical and COMBined, these enums will be interpreted as aliases of ON. Then, when queried, ON will be returned.
Preset	OFF for Swept SA measurement; ON for all other measurements that support Pre-Adjust for Min Clip
State Saved	Saved in instrument state
Initial S/W Revision	Prior to A.02.00
Modified at S/W Revision	A.03.00

### Peak to Average

The Peak to Average Ratio is used with the Range setting to optimize the level control in the instrument. The value is the ratio, in dB, of the peak power to the average power of the signal to be measured. A ratio of 0 should be used for sinusoidal signals; for 802.11g OFDM signals use 9 dB.

All Applications (Modes) will show the current value of Peak to Average ratio on the softkey. However, some applications will not permit changing the value. In these situations the softkey will be grayed-out.

Key Path	AMPTD Y Scale, Range
Remote Command	<code>[ :SENSe ] :POWer [ :RF ] :RANGe:PARatio &lt;real&gt;</code> <code>[ :SENSe ] :POWer [ :RF ] :RANGe:PARatio?</code>
Example	POW:RANG:PAR 12 dB
Notes	In some Applications (Modes) this parameter will be read-only; meaning the value will appear on the softkey and query via SCPI, but not changeable. In such applications the softkey will be grayed-out. Attempting to change the value via SCPI will be ignored and no error message will be generated.
Preset	10 dB
State Saved	Saved in instrument state
Min	0 dB
Max	20 dB
Initial S/W Revision	A.13.00

### Mixer Level Offset

Mixer level offset is an advanced setting to adjust target Range at the input mixer which in turn affects the signal level in the instrument's IF. This setting can be used when additional optimization is needed after setting Peak to Average ratio. Positive values of offset optimize noise performance over distortion, negative values optimize distortion performance over noise.

Key Path	AMPTD Y Scale, Range
Remote Command	<code>[ :SENSe ] :POWer [ :RF ] :RANGe:MIXer:OFFSet &lt;real&gt;</code>

	<code>[ :SENSe ] :POWer [ :RF ] :RANGe :MIXer :OFFSet ?</code>
<b>Example</b>	POW:RANG:MIX:OFFS -5 dB
Preset	0 dB
State Saved	Saved in instrument state
Min	-35 dB
Max	30 dB
Initial S/W Revision	A.13.00

## Scale/Div

Sets the units-per-division of the vertical scale in the logarithmic display. When Auto Scaling is On, the scale per division value is automatically determined by the measurement result. When you set a value manually, Auto Scaling automatically changes to Off.

Key Path	AMPTD Y Scale
Mode	SA, WCDMA, C2K, WIMAX OFDMA, TD-SCDMA, 1xEVDO, DTMB (CTTB), DVB-T/H, ISDB-T, CMMB, LTE, LTE-TDD, Digital Cable TV, WLAN, MSR, LTEAFDD, LTEATDD
<b>Remote Command</b>	<code>:DISPlay:SEMask:VIEW[1]:WINDow[1]:TRACe:Y[:SCALE]:PDIVision &lt;rel_ampl&gt;</code> <code>:DISPlay:SEMask:VIEW[1]:WINDow[1]:TRACe:Y[:SCALE]:PDIVision?</code>
<b>Example</b>	DISP:SEM:VIEW:WIND:TRAC:Y:PDIV 15dB DISP:SEM:VIEW:WIND:TRAC:Y:PDIV?
Notes	You must be in the mode that includes SEM measurement to use this command. Use <code>:INSTrument:SElect</code> to set the mode.
Couplings	When the Auto Scaling is On, this value is automatically determined by the measurement result. When you set a value manually, Auto Scaling automatically changes to Off.
Preset	10 dB
State Saved	Saved in instrument state
Min	0.10 dB
Max	20.00 dB
Initial S/W Revision	Prior to A.02.00
Modified at S/W Revision	A.02.00, A.03.00

## Ref Position

Positions the reference level at the top, center or bottom of the Y scale display. Changing the reference position does not affect the reference level value.

Key Path	AMPTD Y Scale
Mode	SA, WCDMA, C2K, WIMAX OFDMA, TD-SCDMA, 1xEVDO, DTMB (CTTB), DVB-T/H, ISDB-T, CMMB, LTE, LTE-TDD, Digital Cable TV, WLAN, MSR, LTEAFDD, LTEATDD

<b>Remote Command</b>	:DISPlay:SEMask:VIEW[1]:WINDow[1]:TRACe:Y[:SCALe]:RPOStion TOP   CENTer   BOTTom  :DISPlay:SEMask:VIEW[1]:WINDow[1]:TRACe:Y[:SCALe]:RPOStion?
<b>Example</b>	DISP:SEM:VIEW:WIND:TRAC:Y:RPOS BOTT DISP:SEM:VIEW:WIND:TRAC:Y:RPOS?
<b>Notes</b>	You must be in the mode that includes SEM measurement to use this command. Use :INSTrument:SElect to set the mode.
<b>Preset</b>	TOP
<b>State Saved</b>	Saved in instrument state
<b>Range</b>	Top Ctr Bot
<b>Initial S/W Revision</b>	Prior to A.02.00
<b>Modified at S/W Revision</b>	A.02.00, A.03.00

## Auto Scaling

Toggles the Auto Scaling function between On and Off.

When Auto Scaling is On and the Restart front-panel key is pressed, the analyzer automatically determines the scale per division and reference values based on the measurement results. When you set a value to either Scale/Div or Ref Value manually, Auto Scaling automatically changes to Off.

<b>Key Path</b>	AMPTD Y Scale
<b>Mode</b>	SA, WCDMA, C2K, WIMAX OFDMA, TD-SCDMA, 1xEVDO, DTMB (CTTB), DVB-T/H, ISDB-T, CMMB, LTE, LTE-TDD, Digital Cable TV, WLAN, MSR, LTEAFDD, LTEATDD
<b>Remote Command</b>	:DISPlay:SEMask:VIEW[1]:WINDow[1]:TRACe:Y[:SCALe]:COUPle 0   1   ON   OFF  :DISPlay:SEMask:VIEW[1]:WINDow[1]:TRACe:Y[:SCALe]:COUPle?
<b>Example</b>	DISP:SEM:VIEW:WIND:TRAC:Y:COUP OFF DISP:SEM:VIEW:WIND:TRAC:Y:COUP?
<b>Notes</b>	You must be in the mode that includes SEM measurement to use this command. Use :INSTrument:SElect to set the mode.
<b>Couplings</b>	When Auto Scaling is On, upon pressing the Restart front-panel key, this function automatically determines the scale per division and reference values based on the measurement results. When you set a value to either Scale/Div or Ref Value manually, Auto Scaling automatically changes to Off.
<b>Preset</b>	ON
<b>State Saved</b>	Saved in instrument state
<b>Range</b>	On Off
<b>Initial S/W Revision</b>	Prior to A.02.00
<b>Modified at S/W Revision</b>	A.02.00, A.03.00



## Auto Couple

The Auto Couple feature provides a quick and convenient way to automatically couple multiple instrument settings. This helps ensure accurate measurements and optimum dynamic range. When the Auto Couple feature is activated, either from the front panel or remotely, all parameters of the current measurement that have an Auto/Manual mode are set to Auto mode and all measurement settings dependent on (or coupled to) the Auto/Man parameters are automatically adjusted for optimal performance.

However, the Auto Couple key actions are confined to the current measurement only. It does not affect other measurements in the mode, and it does not affect markers, marker functions, or trace or display attributes.

See "[More Information](#)" on page 909

Key Path	Front-panel key
Remote Command	:COUPle ALL NONE
Example	:COUP ALL
Notes	:COUPle ALL puts all Auto/Man parameters in Auto mode (equivalent to pressing the Auto Couple key). :COUPLE NONE puts all Auto/Man parameters in manual mode. It decouples all the coupled instrument parameters and is not recommended for making measurements.
Initial S/W Revision	Prior to A.02.00

### More Information

There are two types of functions that have Auto/Manual modes.

#### Auto/Man Active Function keys

An Auto/Man toggle key controls the binary state associated with an instrument parameter by toggling between Auto (where the parameter is automatically coupled to the other parameters it is dependent upon) and Man (where the parameter is controlled independent of the other parameters), as well as making the parameter the active function. The current mode is indicated on the softkey with either Auto or Man underlined as illustrated below.

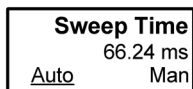

vsd07

#### Auto/Man 1-of-N keys

An Auto/Man 1-of-N key allows you to manually pick from a list of parameter values, or place the function in Auto, in which case the value is automatically selected (and indicated) as shown below. If in Auto, Auto is underlined on the calling key. If in manual operation, manual is indicated on the calling key. But the calling key does not actually toggle the function, it simply opens the menu.

10 Spectrum Emission Mask Measurement  
Auto Couple

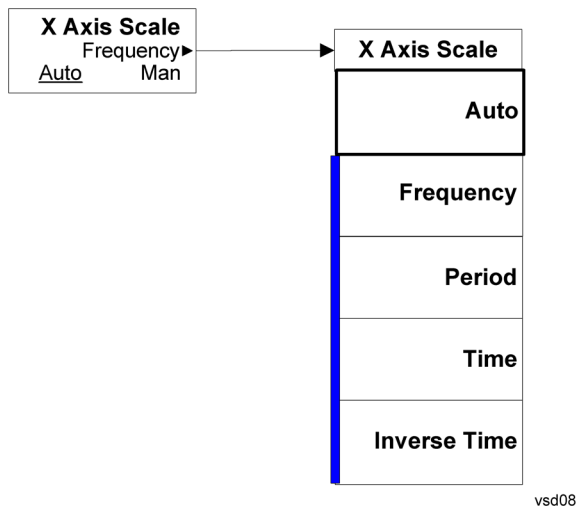

## BW

Accesses a menu of functions that enable you to select the type of filter for the measurement.

Key Path	Front-panel key
Initial S/W Revision	Prior to A.02.00
Modified at S/W Revision	A.03.00

## Filter Type

Selects the type of bandwidth filter that is used in Carrier and Offsets.

When Gaussian or Flattop is selected, selected filter is applied to carriers and all offsets.

When Auto Sense is selected, filter type is automatically selected for each carriers and offsets, so that measurement speed and accuracy is optimized.

Key Path	BW
Mode	SA, WCDMA, C2K, WIMAX OFDMA, TD-SCDMA, 1xEVDO, DVB-T/H, DTMB (CTTB), ISDB-T, CMMB, LTE, LTE-TDD, Digital Cable TV, WLAN, MSR, LTEAFDD, LTEATDD
<b>Remote Command</b>	[ :SENSe ] :SEMAsk :BANDwidth :SHAPE ASENse   GAUSSsian   FLATtop [ :SENSe ] :SEMAsk :BANDwidth :SHAPE?
<b>Example</b>	SEM:BAND:SHAP GAUS SEM:BAND:SHAP?
Couplings	See the description above
Preset	ASENse
State Saved	Saved in instrument state
Range	Auto Sense (each offset and carrier) Gaussian (all offsets and carriers) Flattop (all offsets and carriers)
Initial S/W Revision	A.03.00

## Cont (Continuous Measurement/Sweep)

Sets the analyzer for Continuous measurement operation. The single/continuous state is Meas Global so the setting will affect all measurements. If you are Paused, pressing Cont does a Resume.

<b>Key Path</b>	Front-panel key
<b>Remote Command</b>	:INITiate:CONTinuous OFF ON 0 1 :INITiate:CONTinuous?
<b>Example</b>	:INIT:CONT 0 puts analyzer in Single measurement operation. :INIT:CONT 1 puts analyzer in Continuous measurement operation
<b>Preset</b>	ON (Note that SYST:PRESet sets INIT:CONT to ON but *RST sets INIT:CONT to OFF)
<b>State Saved</b>	Saved in instrument state
<b>Backwards Compatibility Notes</b>	For Spectrum Analysis mode in ESA and PSA, there is no Cont hardkey, instead there is a Sweep Single/Cont key. In these analyzers, switching the Sweep Single/Cont key from Single to Cont restarts averages (displayed average count reset to 1), but does not restart Max Hold and Min Hold. The X-Series has Single and Cont keys in place of the SweepSingleCont key. In the X-Series, if in single measurement, the Cont key (and INIT:CONT ON ) switches to continuous measurement, but never restarts a measurement and never resets a sweep.
<b>Initial S/W Revision</b>	Prior to A.02.00

In Swept SA Measurement (Spectrum Analysis Mode):

The analyzer takes repetitive sweeps, averages, measurements, etc., when in Continuous mode. When the average count reaches the Average/Hold Number the count stops incrementing, but the analyzer keeps sweeping. See the Trace/Detector section for the averaging formula used both before and after the Average/Hold Number is reached. The trigger condition must be met prior to each sweep. The type of trace processing for multiple sweeps, is set under the Trace/Detector key, with choices of Trace Average, Max Hold, or Min Hold.

In Other Measurements/Modes:

With Avg/Hold Num (in the Meas Setup menu) set to Off or set to On with a value of 1, a sweep is taken after the trigger condition is met; and the analyzer continues to take new sweeps after the current sweep has completed and the trigger condition is again met. However, with Avg/Hold Num set to On with a value >1, multiple sweeps (data acquisitions) are taken for the measurement. The trigger condition must be met prior to each sweep. The sweep is not stopped when the average count k equals the number N set for Avg/Hold Num is reached, but the number k stops incrementing. A measurement average usually applies to all traces, marker results, and numeric results. But sometimes it only applies to the numeric results.

If the analyzer is in Single measurement, pressing the Cont key does not change k and does not cause the sweep to be reset; the only action is to put the analyzer into Continuous measurement operation.

If it is already in continuous sweep:

the INIT:CONT 1 command has no effect

the INIT:CONT 0 command will place the analyzer in Single Sweep but will have no effect on the current sequence until  $k = N$ , at which point the current sequence will stop and the instrument will go to the idle state.

10 Spectrum Emission Mask Measurement  
File

File

See "File" on page 178

## FREQ Channel

Accesses a menu of keys that allow you to control the Frequency and Channel parameters of the instrument.

Some features in the Frequency menu are the same for all measurements – they do not change as you change measurements. Settings like these are called “Meas Global” and are unaffected by Meas Preset. For example, the Center Freq setting is the same for all measurements – it does not change as you change measurements.

Key Path	Front-panel key
Initial S/W Revision	Prior to A.02.00

### Center Freq

Sets the frequency that corresponds to the horizontal center of the graticule (when frequency Scale Type is set to linear). While adjusting the Center Frequency the Span is held constant, which means that both Start Frequency and Stop Frequency will change.

Pressing Center Freq also sets the frequency entry mode to Center/Span. In Center/Span mode, the center frequency and span values are displayed below the graticule, and the default active function in the Frequency menu is Center Freq.

The center frequency setting is the same for all measurements within a mode, that is, it is Meas Global. Some modes are also able to share a Mode Global center frequency value. If this is the case, the Mode will have a Global Settings key in its Mode Setup menu.

The Center Freq function sets (and queries) the Center Frequency for the currently selected input. If your analyzer has multiple inputs, and you select another input, the Center Freq changes to the value for that input. SCPI commands are available to directly set the Center Freq for a specific input.

Center Freq is remembered as you go from input to input. Thus you can set a Center Freq of 10 GHz with the RF Input selected, change to BBIQ and set a Center Freq of 20 MHz, then switch to External Mixing and set a Center Freq of 60 GHz, and when you go back to the RF Input the Center Freq will go back to 10 GHz; back to BBIQ and it is 20 MHz; back to External Mixing and it is 60 GHz.

See ["RF Center Freq" on page 918](#)

See [Ext Mix Center Freq](#)

See ["I/Q Center Freq" on page 920](#)

See ["Center Frequency Presets" on page 916](#)

Key Path	FREQ Channel
Scope	Meas Global
Remote Command	[ :SENSe ] :FREQuency:CENTer <freq> [ :SENSe ] :FREQuency:CENTer?
Example	FREQ:CENT 50 MHz

	FREQ:CENT UP changes the center frequency to 150 MHz if you use FREQ:CENT:STEP 100 MHz to set the center frequency step size to 100 MHz FREQ:CENT?
Notes	This command sets either the RF or I/Q Center Frequency depending on the selected input. For RF input it is equivalent to FREQ:RF:CENT For I/Q input it is equivalent to FREQ:IQ:CENT Preset and Max values are dependent on Hardware Options (5xx) If no terminator (e.g. MHz) is sent the terminator Hz is used. If a terminator with unit other than Frequency is used, an invalid suffix error message is generated.
Dependencies	The Center Frequency can be limited by Start or Stop Freq limits, if the Span is so large that Start or Stop reach their limit.
Couplings	When operating in "swept span", any value of the Center Frequency or Span that is within the frequency range of the analyzer is allowed when the value is being set through the front panel numeric key pad or the SCPI command. The other parameter is forced to a different value if needed, to keep the Start and the Stop Frequencies within the analyzer's frequency range
Preset	Depends on instrument maximum frequency, mode, measurement, and selected input. See " <a href="#">Center Frequency Presets</a> " on page 916 and " <a href="#">RF Center Freq</a> " on page 918 and <a href="#">Ext Mix Center Freq</a> and " <a href="#">I/Q Center Freq</a> " on page 920.
State Saved	Saved in instrument state
Min	Depends on instrument maximum frequency, mode, measurement, and selected input.. See " <a href="#">Center Frequency Presets</a> " on page 916 and " <a href="#">RF Center Freq</a> " on page 918 and " <a href="#">I/Q Center Freq</a> " on page 920.
Max	Depends on instrument maximum frequency, mode, measurement, and selected input.. See " <a href="#">Center Frequency Presets</a> " on page 916 and " <a href="#">RF Center Freq</a> " on page 918 and " <a href="#">I/Q Center Freq</a> " on page 920.
Default Unit	Hz
Status Bits/OPC	Non-overlapped
Dependencies	
Initial S/W Revision	Prior to A.02.00

## Center Frequency Presets

The following table provides the Center Frequency Presets for the Spectrum Analyzer mode, and the Max Freq, for the various frequency options:

Freq Option	CF after Mode Preset	Stop Freq after Mode Preset	Max Freq (can't tune above)



503 (all but N9000A)	1.805 GHz	3.6 GHz	3.7 GHz
503 (N9000A)	1.505 GHz	3.0 GHz	3.08 GHz
504 (M9420A)	1 GHz	3.8GHz	3.88 GHz
506 (M9420A)	1 GHz	6.0GHz	6.08 GHz
507 (all but N9000A)	3.505 GHz	7.0 GHz	7.1 GHz
507 (N9000A)	3.755 GHz	7.5 GHz	7.58 GHz
508 (all but N9038A)	1.805 GHz	3.6 GHz	8.5 GHz
508 (N9038A)	4.205 GHz	8.4 GHz	8.5 GHz
513	6.805 GHz	13.6 GHz	13.8 GHz
526 (all but N9000A and N9038A)	13.255 GHz	26.5 GHz	27.0 GHz
526 (N9000A)	13.255 GHz	26.5 GHz	26.55 GHz
526 (N9038A)	1.805 GHz	3.6 GHz	27.0 GHz
532	16.005 GHz	32.0 GHz	32.5 GHz
543	21.505 GHz	43.0 GHz	TBD
544	22.005 GHz	44.0 GHz	44.5 GHz
550	25.005 GHz	50.0 GHz	51 GHz

Input 2:

Model	CF after Mode Preset	Stop Freq after Mode Preset	Max Freq (can't tune above)
N9000A opt C75	0.7505GHz	1.5 GHz	1.58 GHz
N9038A	505 MHz	1 GHz	1.000025 GHz

Tracking Generator Frequency Limits (N9000A only):

Tracking Generator Option	Min Freq (clips to this freq when turn TG on and can't tune below while TG on)	If above this Freq, Stop Freq clipped to this Freq when TG turned on	Max Freq (can't tune above) while TG on
T03	9 kHz	3.0 GHz	3.08 GHz
T06	9 kHz	6.0 GHz	6.05 GHz

The following table shows the Center Frequency Presets for modes other than Spectrum Analyzer:

Mode	CF Preset for RF
WCDMA	1 GHz
WIMAXOFDMA,	1 GHz
BASIC	1 GHz
ADEMOD	1 GHz
VSA	1 GHz
TDSCDMA	1 GHz
PNOISE	1 GHz
LTE	1 GHz
LTETDD	1 GHz
MSR	1 GHz
GSM	935.2 MHz
NFIGURE	1.505 GHz

## RF Center Freq

SCPI command for specifying the RF Center Frequency. This command will set the Center Frequency to be used when the RF input is selected, even if the RF input is not the input that is selected at the time the command is sent. Note that the Center Freq function in the Frequency menu on the front panel always applies to the currently selected input.

Scope	Meas Global
<b>Remote Command</b>	<code>[ :SENSe ] :FREQuency:RF:CENTer &lt;freq&gt;</code> <code>[ :SENSe ] :FREQuency:RF:CENTer?</code>
<b>Example</b>	FREQ:RF:CENT 30 MHz
Notes	This command is the same in all modes, but the parameter is Measurement Global. So the value is independent in each mode and common across all the measurements in the mode.
Dependencies	If the electronic/soft attenuator is enabled, any attempt to set Center Frequency such that the Stop Frequency would be >3.6 GHz fails and results in an advisory message. If the equivalent SCPI

	command is sent, this same message is generated as part of a “-221, Settings conflict” warning. If Source Mode is set to Tracking, and the Max or Min Center Freq is therefore limited by the limits of the source, a warning message is generated, “Data out of range;clipped to source max/min” if these limits are exceeded. Note that for an external source, these limits can be affected by the settings of Source Numerator, Source Denominator and Power Sweep.
Preset	See table above
State Saved	Saved in instrument state.
Min	-79.999995 MHz, unless Source Mode is set to Tracking, in which case it is limited by the minimum frequency of the Source
Max	See table above. Basically instrument maximum frequency - 5 Hz. Note that, if the Source Mode is set to Tracking, the effective instrument maximum frequency may be limited by the source maximum frequency. If the knob or step keys are being used, also depends on the value of the other three interdependent parameters Span, Start Frequency and Stop Frequency
Initial S/W Revision	Prior to A.02.00
Modified at S/W Revision	A.03.00

## Ext Mix Center Freq

SCPI command for specifying the External Mixer Center Frequency. This command will set the Center Frequency to be used when the External Mixer is selected, even if the External Mixer input is not the input which is selected at the time the command is sent. Note that the Center Freq function in the Frequency menu on the front panel always applies to the currently selected input.

Scope	Meas Global
<b>Remote Command</b>	<code>[ :SENSe ] :FREQuency:EMIXer:CENTer &lt;freq&gt;</code> <code>[ :SENSe ] :FREQuency:EMIXer:CENTer?</code>
<b>Example</b>	<code>:FREQ:EMIX:CENT 60 GHz</code> <code>:FREQ:EMIX:CENT?</code>
Notes	This command is the same in all modes, but the parameter is Measurement Global. So the value is independent in each mode and common across all the measurements in the mode.
Couplings	When returning to External Mixing after having been switched to one of the other inputs (e.g., RF), you will come back into the settings that you had when you left External Mixing. So you will come back to the band you were in with the Center Frequency that you had. However, Span is not an input-dependent parameter, therefore you will bring the span over from the other input. Therefore, the analyzer comes back with the span from the previous input, limited as necessary by the current mixer setup.
Preset	When a Mode Preset is performed while in External Mixing, the Start frequency of the current Mode is set to the nominal Min Freq of the lowest harmonic range in the Harmonic Table for the current mixer setup. Similarly, the Stop frequency of the current Mode is set to the nominal Max Freq of the highest harmonic range in the Harmonic Table. The Center Freq thus presets to the point arithmetically equidistant from these two frequencies.

	<p>If the current measurement has a limited Span available to it, and cannot achieve the Span shown in the table (Span=Stop Freq – Start Freq), the analyzer uses the maximum Span the measurement allows, and still sets the Center Freq to the midpoint of the Start and Stop Freq values in the Harmonic Table.</p> <p>When Restore Input/Output Defaults is performed, the mixer presets to the 11970A, whose Start and Stop frequencies are 26.5 and 40 GHz respectively. The center of these two frequencies is 33.25 GHz.</p> <p>Therefore, after a Restore Input/Output Defaults, if you go into External Mixing and do a Mode Preset while in the Spectrum Analyzer Mode, the resulting Center Freq is 33.25 GHz.</p>
State Saved	Saved in instrument state.
Min	The minimum frequency in the currently selected mixer band + 5 Hz
Max	The maximum frequency in the currently selected mixer band – 5 Hz If the knob or step keys are being used, also depends on the value of the other three interdependent parameters Span, Start Frequency and Stop Frequency
Initial S/W Revision	A.08.01

### I/Q Center Freq

SCPI command for specifying the I/Q Center Frequency. This command will set the Center Frequency to be used when the I/Q input is selected, even if the I/Q input is not the input which is selected at the time the command is sent. Note that the Center Freq function in the Frequency menu on the front panel always applies to the currently selected input.

Scope	Meas Global
<b>Remote Command</b>	[ :SENSe ] :FREQuency:IQ:CENTer <freq> [ :SENSe ] :FREQuency:IQ:CENTer?
<b>Example</b>	FREQ:IQ:CENt: 30 MHz
Notes	This command is the same in all modes, but the parameter is Measurement Global. So the value is independent in each mode and common across all the measurements in the mode.
Preset	0 Hz
State Saved	Saved in instrument state.
Min	-40.049995 MHz
Max	40.049995 MHz
Initial S/W Revision	Prior to A.02.00

## Input/Output

See "Input/Output" on page 118

## Marker

Accesses a menu that enables you to select, set up and control the markers for the current measurement. If there are no active markers, Marker selects marker 1, sets it to Normal and places it at the center of the display. You can turn on and control up to 12 markers.

Key Path	Front-panel key
Initial S/W Revision	Prior to A.02.00

### Select Marker

Displays 12 markers available for selection.

Key Path	Marker
Initial S/W Revision	Prior to A.02.00

### Marker Type

Sets the marker control mode to Normal and Off. If the selected marker is Off, pressing Marker sets it to Normal and places it at the center of the screen on the trace determined by the Marker Trace rules. At the same time, Marker X Axis Value appears on the Active Function area. The marker X axis value entered in the active function area will display the marker value to its full entered precision. If the current control mode for the measurement is Off, there is no active function and the active function is turned off.

Key Path	Marker
Mode	SA, WCDMA, C2K, WIMAX OFDMA, TD-SCDMA, 1xEVDO, DTMB (CTTB), DVB-T/H, ISDB-T, CMMB, LTE, LTE-TDD, Digital Cable TV, WLAN, MSR, LTEAFDD, LTEATDD
Remote Command	:CALCulate:SEMask:MARKer[1] 2 ... 12:MODE POSITION OFF :CALCulate:SEMask:MARKer[1] 2 ... 12:MODE?
Example	CALC:SEM:MARK:MODE POS CALC:SEM:MARK:MODE?
Notes	If the selected marker is Off, pressing Marker sets it to Normal and places it at the center of the screen on the trace determined by the Marker Trace rules. At the same time, Marker X Axis Value appears on the Active Function area.  Default Active Function: the active function for the selected marker's current control mode. Note that if the current control mode is Off, there is no active function and the active function is turned off.  Active Function Display: the marker X axis value entered in the active function area will display the marker value to its full entered precision.
Preset	OFF OFF OFF OFF OFF OFF OFF OFF OFF OFF OFF OFF
State Saved	Saved in instrument state
Range	Normal Off
Initial S/W Revision	Prior to A.02.00
Modified at S/W Revision	A.02.00, A.03.00

## Couple Markers

When this function is true, moving any marker causes an equal X Axis movement of every other marker that is not Off. By “equal X Axis movement” we mean that we preserve the difference between each marker’s X Axis value (in the fundamental x-axis units of the trace that marker is on) and the X Axis value of the marker being moved (in the same fundamental x-axis units).

<b>Key Path</b>	Marker
<b>Mode</b>	SA, WCDMA, C2K, WIMAX OFDMA, TD-SCDMA, 1xEVDO, DTMB (CTTB), DVB-T/H, ISDB-T, CMMB, LTE, LTEFDD, Digital Cable TV, WLAN, MSR, LTEAFDD, LTEATDD
<b>Remote Command</b>	:CALCulate:SEMask:MARKer:COUPle[:STATe] ON OFF 1 0 :CALCulate:SEMask:MARKer:COUPle[:STATe]?
<b>Example</b>	CALC:SEM:MARK:COUP ON CALC:SEM:MARK:COUP?
<b>Preset</b>	OFF
<b>State Saved</b>	Saved in instrument state
<b>Range</b>	On Off
<b>Initial S/W Revision</b>	Prior to A.02.00
<b>Modified at S/W Revision</b>	A.02.00, A.03.00

## All Markers Off

Turns all active markers off in all views.

<b>Key Path</b>	Marker
<b>Mode</b>	SA, WCDMA, C2K, WIMAX OFDMA, TD-SCDMA, 1xEVDO, DTMB (CTTB), DVB-T/H, ISDB-T, CMMB, LTE, LTEFDD, Digital Cable TV, WLAN, MSR, LTEAFDD, LTEATDD
<b>Remote Command</b>	:CALCulate:SEMask:MARKer:AOFF
<b>Example</b>	CALC:SEM:MARK:AOFF
<b>Initial S/W Revision</b>	Prior to A.02.00
<b>Modified at S/W Revision</b>	A.02.00, A.03.00

## Marker X Axis Value (Remote Command Only)

Sets the marker X Axis value in the current marker X Axis Scale unit. It has no effect if the control mode is Off, but is the SCPI equivalent of entering an X value if the control mode is Normal.

<b>Mode</b>	SA, WCDMA, C2K, WIMAX OFDMA, TD-SCDMA, 1xEVDO, DTMB (CTTB), DVB-T/H ISDB-T, CMMB, LTE, LTEFDD, Digital Cable TV, WLAN, MSR, LTEAFDD, LTEATDD
<b>Remote Command</b>	:CALCulate:SEMask:MARKer[1] 2 ... 12:X <freq>

	:CALCulate:SEMask:MARKer[1] 2 ... 12:X?
<b>Example</b>	CALC:SEM:MARK3:X 1.0 GHz CALC:SEM:MARK3:X?
<b>Notes</b>	<p>If no suffix is sent it will use the fundamental units for the current marker X Axis Scale. If a suffix is sent that does not match the current marker X Axis Scale unit, an error "Invalid suffix" will be generated.</p> <p>The query returns the marker's absolute X Axis value if the control mode is Normal. The query is returned in the fundamental units for the current marker X Axis scale. If the marker is Off the response is not a number.</p> <p>When a Marker is turned on, it is placed center of the screen on the trace. Therefore the default value depends on instrument condition, although the Preset/Default is defined as 1.5 GHz.</p>
<b>Preset</b>	After a preset, , all Markers are turned OFF, , so a Marker X Axis Value query will return a not a number (NAN).
<b>State Saved</b>	No
<b>Min</b>	-9.9E+37
<b>Max</b>	9.9E+37
<b>Initial S/W Revision</b>	Prior to A.02.00
<b>Modified at S/W Revision</b>	A.02.00, A.03.00

### Marker X Axis Position (Remote Command Only)

Sets the marker X position in trace points. It has no effect if the control mode is Off, but is the SCPI equivalent of entering a value if the control mode is Normal, except in trace points rather than X Axis Scale units. The entered value is immediately translated into the current X Axis Scale units for setting the value of the marker.

<b>Mode</b>	SA, WCDMA, C2K, WIMAX OFDMA, TD-SCDMA, 1xEVDO, DTMB (CTTB), DVB-T/H, ISDB-T, CMMB, LTE, LTETDD, Digital Cable TV, WLAN, MSR, LTEAFDD, LTEATDD
<b>Remote Command</b>	:CALCulate:SEMask:MARKer[1] 2 ... 12:X:POSition <real> :CALCulate:SEMask:MARKer[1] 2 ... 12:X:POSition?
<b>Example</b>	CALC:SEM:MARK10:X:POS 1001 CALC:SEM:MARK10:X:POS?
<b>Notes</b>	<p>The query returns the marker's absolute X Axis value in trace points if the control mode is Normal. The value is returned as a real number, not an integer, corresponding to the translation from X Axis Scale units to trace points . If the marker is Off the response is not a number.</p> <p>When a Marker is turned on, it is placed center of the screen on the trace. Therefore the default value depends on the instrument condition although the Preset/Default is defined as 6507 (this value might be the expected value when all the offsets are on).</p>
<b>Preset</b>	After a preset, , all Markers are turned OFF, , so a Marker X Axis Value query will return a not a number (NAN).
<b>State Saved</b>	No



Min	-9.9E+37
Max	9.9E+37
Initial S/W Revision	Prior to A.02.00
Modified at S/W Revision	A.02.00, A.03.00

### Marker Y Axis Value (Remote Command Only)

Returns the marker Y Axis value in the current marker Y Axis unit.

Mode	SA, WCDMA, C2K, WIMAX OFDMA, TD-SCDMA, 1xEVDO, DTMB (CTTB), DVB-T/H, ISDB-T, CMMB, LTE, LTE-TDD, Digital Cable TV, WLAN, MSR, LTEAFDD, LTEATDD
<b>Remote Command</b>	:CALCulate:SEMask:MARKer[1] 2 ... 12:Y?
<b>Example</b>	CALC:SEM:MARK11:Y 10 dBm CALC:SEM:MARK11:Y?
Notes	Since the result value is always calculated from acquisition data, the default value is arbitrary, although the Preset/Default values is defined.
Preset	Result dependent on markers setup and signal source
State Saved	No
<b>Backwards Compatibility SCPI</b>	:CALCulate:SEMask:MARKer[1] 2 ... 12:FUNction:RESult?
Initial S/W Revision	Prior to A.02.00
Modified at S/W Revision	A.02.00, A.03.00

## Marker Function

There are no 'Marker Functions' supported in Spectrum Emission Mask so this front-panel key displays a blank menu when pressed.

---

Key Path	Front-panel key
Initial S/W Revision	Prior to A.02.00

---

## Marker To

There is no 'Marker To' functionality supported in Spectrum Emission Mask so this front-panel key displays a blank menu when pressed.

---

Key Path	Front-panel key
Initial S/W Revision	Prior to A.02.00

---

## Meas

The information in this section is common to all measurements. For key and remote command information for a specific measurement, refer to the section that describes the measurement of interest.

Measurements available under the Meas key are specific to the current Mode.

When viewing Help for measurements, note the following:

**NOTE**

Operation for some keys differs between measurements. The information displayed in Help pertains to the current measurement. To see how a key operates in a different measurement, exit Help (press the Cancel Esc key), select the measurement, then reenter Help (press the Help key) and press that key.

---

Key Path	Front-panel key
Initial S/W Revision	Prior to A.02.00

---

### Remote Measurement Functions

This section contains the following topics:

["Measurement Group of Commands" on page 1269](#)

["Current Measurement Query \(Remote Command Only\)" on page 1271](#)

["Limit Test Current Results \(Remote Command Only\)" on page 1271](#)

["Data Query \(Remote Command Only\)" on page 1271](#)

["Calculate/Compress Trace Data Query \(Remote Command Only\)" on page 1272](#)

["Calculate Peaks of Trace Data \(Remote Command Only\)" on page 1277](#)

["Hardware-Accelerated Fast Power Measurement \(Remote Command Only\)" on page 1278](#)

["Format Data: Numeric Data \(Remote Command Only\)" on page 1292](#)

["Format Data: Byte Order \(Remote Command Only\)" on page 1293](#)

---

Initial S/W Revision	Prior to A.02.00
----------------------	------------------

---

## Measurement Group of Commands

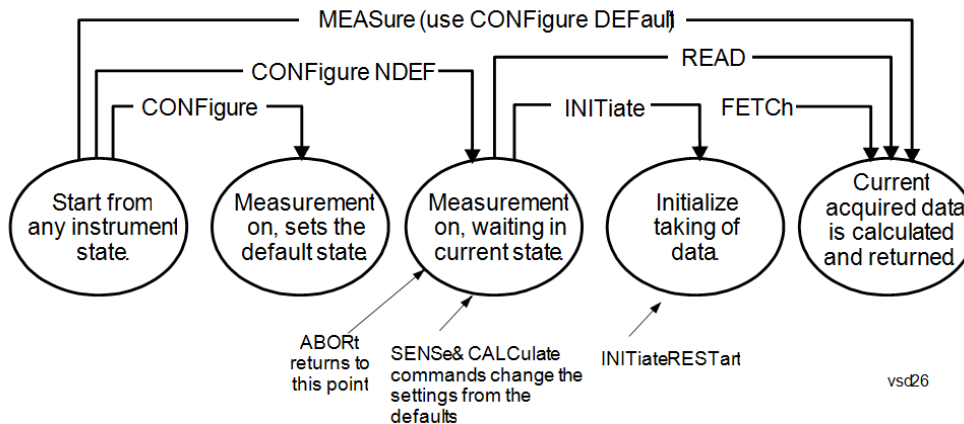

---

### Measure Commands:

:MEASure:<measurement>[n]?

This is a fast single-command way to make a measurement using the factory default instrument settings. These are the settings and units that conform to the Mode Setup settings (e.g. radio standard) that you have currently selected.

- Stops the current measurement (if any) and sets up the instrument for the specified measurement using the factory defaults
- Initiates the data acquisition for the measurement
- Blocks other SCPI communication, waiting until the measurement is complete before returning results.
- If the function does averaging, it is turned on and the number of averages is set to 10.
- After the data is valid it returns the scalar results, or the trace data, for the specified measurement. The type of data returned may be defined by an [n] value that is sent with the command.
- The scalar measurement results will be returned if the optional [n] value is not included, or is set to 1. If the [n] value is set to a value other than 1, the selected trace data results will be returned. See each command for details of what types of scalar results or trace data results are available.
- ASCII is the default format for the data output. (Older versions of Spectrum Analysis and Phase Noise mode measurements only use ASCII.) The binary data formats should be used for handling large blocks of data since they are smaller and faster than the ASCII format. Refer to the FORMat:DATA command for more information.

If you need to change some of the measurement parameters from the factory default settings you can set up the measurement with the CONFigure command. Use the commands in the SENSe:<measurement> and CALCulate:<measurement> subsystems to change the settings. Then you can use the READ? command to initiate the measurement and query the results.

If you need to repeatedly make a given measurement with settings other than the factory defaults, you can use the commands in the SENSe:<measurement> and CALCulate:<measurement> subsystems to set up the measurement. Then use the READ? command to initiate the measurement and query results.

Measurement settings persist if you initiate a different measurement and then return to a previous one. Use READ:<measurement>? if you want to use those persistent settings. If you want to go back to the default settings, use MEASure:<measurement>?.

---

### Configure Commands:

:CONFigure:<measurement>

This command stops the current measurement (if any) and sets up the instrument for the specified measurement using

---

---

the factory default instrument settings. It does not initiate the taking of measurement data unless INIT:CONTinuous is ON. If you change any measurement settings after using the CONFigure command, the READ command can be used to initiate a measurement without changing the settings back to their defaults.

In the Swept SA measurement in Spectrum Analyzer mode the CONFigure command also turns the averaging function on and sets the number of averages to 10 for all measurements.

:CONFigure: <measurement>: NDEFault stops the current measurement and changes to the specified measurement. It does not change the settings to the defaults. It does not initiate the taking of measurement data unless INIT:CONTinuous is ON.

The CONFigure? query returns the current measurement name.

The CONFigure:CATalog? query returns a quoted string of all licensed measurement names in the current mode. For example, "SAN, CHP, OBW, ACP, PST, TXP, SPUR, SEM, LIST".

---

#### Fetch Commands:

---

:FETCh:<measurement>[n]?

This command puts selected data from the most recent measurement into the output buffer. Use FETCh if you have already made a good measurement and you want to return several types of data (different [n] values, for example, both scalars and trace data) from a single measurement. FETCh saves you the time of re-making the measurement. You can only FETCh results from the measurement that is currently active, it will not change to a different measurement. An error message is reported if a measurement other than the current one is specified.

If you need to get new measurement data, use the READ command, which is equivalent to an INITiate followed by a FETCh.

The scalar measurement results will be returned if the optional [n] value is not included, or is set to 1. If the [n] value is set to a value other than 1, the selected trace data results will be returned. See each command for details of what types of scalar results or trace data results are available. The binary data formats should be used for handling large blocks of data since they are smaller and transfer faster than the ASCII format. (FORMat:DATA)

FETCh may be used to return results other than those specified with the original READ or MEASure command that you sent.

---

#### INITiate Commands:

---

:INITiate:<measurement>

This command is not available for measurements in all the instrument modes:

- Initiates a trigger cycle for the specified measurement, but does not output any data. You must then use the FETCh<meas> command to return data. If a measurement other than the current one is specified, the instrument will switch to that measurement and then initiate it.
  - For example, suppose you have previously initiated the ACP measurement, but now you are running the channel power measurement. If you send INIT:ACP? it will change from channel power to ACP and will initiate an ACP measurement.
  - Does not change any of the measurement settings. For example, if you have previously started the ACP measurement and you send INIT:ACP? it will initiate a new ACP measurement using the same instrument settings as the last time ACP was run.
  - If your selected measurement is currently active (in the idle state) it triggers the measurement, assuming the trigger conditions are met. Then it completes one trigger cycle. Depending upon the measurement and the number of averages, there may be multiple data acquisitions, with multiple trigger events, for one full trigger cycle. It also holds off additional commands on GPIB until the acquisition is complete.
- 

#### READ Commands:

---

:READ:<measurement>[n]?

- Does not preset the measurement to the factory default settings. For example, if you have previously initiated the ACP
-

---

measurement and you send READ:ACP? it will initiate a new measurement using the same instrument settings.

- Initiates the measurement and puts valid data into the output buffer. If a measurement other than the current one is specified, the instrument will switch to that measurement before it initiates the measurement and returns results.
  - For example, suppose you have previously initiated the ACP measurement, but now you are running the channel power measurement. Then you send READ:ACP? It will change from channel power back to ACP and, using the previous ACP settings, will initiate the measurement and return results.
  - Blocks other SCPI communication, waiting until the measurement is complete before returning the results
  - If the optional [n] value is not included, or is set to 1, the scalar measurement results will be returned. If the [n] value is set to a value other than 1, the selected trace data results will be returned. See each command for details of what types of scalar results or trace data results are available. The binary data formats should be used when handling large blocks of data since they are smaller and faster than the ASCII format. (FORMat:DATA)
- 

---

Initial S/W Revision	Prior to A.02.00
----------------------	------------------

---

### Current Measurement Query (Remote Command Only)

This command returns the name of the measurement that is currently running.

---

<b>Remote Command</b>	:CONFigure?
-----------------------	-------------

<b>Example</b>	CONF?
----------------	-------

Initial S/W Revision	Prior to A.02.00
----------------------	------------------

---

### Limit Test Current Results (Remote Command Only)

Queries the status of the current measurement limit testing. It returns a 0 if the measured results pass when compared with the current limits. It returns a 1 if the measured results fail any limit tests.

---

<b>Remote Command</b>	:CALCulate:CLIMits:FAIL?
-----------------------	--------------------------

<b>Example</b>	CALC:CLIM:FAIL? queries the current measurement to see if it fails the defined limits. Returns a 0 or 1: 0 it passes, 1 it fails.
----------------	--------------------------------------------------------------------------------------------------------------------------------------

Initial S/W Revision	Prior to A.02.00
----------------------	------------------

---

### Data Query (Remote Command Only)

Returns the designated measurement data for the currently selected measurement and subopcode.

n = any valid subopcode for the current measurement. See the measurement command results table for your current measurement, for information about what data is returned for the subopcodes.

This command uses the data setting specified by the FORMat:BORDER and FORMat:DATA commands and can return real or ASCII data. (See the format command descriptions under Input/Output in the Analyzer Setup section.)

<b>Remote Command</b>	:CALCulate:DATA[n]?
<b>Notes</b>	The return trace depends on the measurement. In CALCulate:<meas>:DATA[n], n is any valid subopcode for the current measurement. It returns the same data as the FETCH:<measurement>? query where <measurement> is the current measurement.
<b>Initial S/W Revision</b>	Prior to A.02.00

### Calculate/Compress Trace Data Query (Remote Command Only)

Returns compressed data for the currently selected measurement and sub-opcode [n].

n = any valid sub-opcode for that measurement. See the MEASure:<measurement>? command description of your specific measurement for information on the data that can be returned.

The data is returned in the current Y Axis Unit of the analyzer. The command is used with a sub-opcode <n> (default=1) to specify the trace. With trace queries, it is best if the analyzer is not sweeping during the query. Therefore, it is generally advisable to be in Single Sweep, or Update=Off.

This command is used to compress or decimate a long trace to extract and return only the desired data. A typical example would be to acquire N frames of GSM data and return the mean power of the first burst in each frame. The command can also be used to identify the best curve fit for the data.

<b>Remote Command</b>	:CALCulate:DATA<n>:COMPRESS? BLOCK   CFIT   MAXimum   MINimum   MEAN   DMEan   RMS   RMSCubed   SAMPLE   SDEVIation   PPHase [,<soffset> [,<length>[,<roffset>[,<rlimit>]]]]
<b>Example</b>	To query the mean power of a set of GSM bursts: Supply a signal that is a set of GSM bursts. Select the IQ Waveform measurement (in IQ Analyzer Mode). Set the sweep time to acquire at least one burst. Set the triggers such that acquisition happens at a known position relative to a burst. Then query the mean burst levels using, CALC:DATA2:COMP? MEAN, 24e-6, 526e-6 (These parameter values correspond to GSM signals, where 526e-6 is the length of the burst in the slot and you just want 1 burst.)
<b>Notes</b>	The command supports 5 parameters. Note that the last 4 (<soffset>, <length>, <roffset>, <rlimit>) are optional. But these optional parameters must be entered in the specified order. For example, if you want to specify <length>, then you must also specify <soffset>. See details below for a definition of each of these parameters.  This command uses the data in the format specified by FORMat:DATA, returning either binary or ASCII data.
<b>Initial S/W Revision</b>	Prior to A.02.00

- BLOCK or block data - returns all the data points from the region of the trace data that you specify. For example, it could be used to return the data points of an input signal over several timeslots, excluding the portions of the trace data that you do not want. (This is x,y pairs for trace data and I,Q pairs for complex data.)



- CFIT or curve fit - applies curve fitting routines to the data. <soffset> and <length> are required to define the data that you want. <roffset> is an optional parameter for the desired order of the curve equation. The query will return the following values: the x-offset (in seconds) and the curve coefficients ((order + 1) values).

MIN, MAX, MEAN, DME, RMS, RMSC, SAMP, SDEV and PPH return one data value for each specified region (or <length>) of trace data, for as many regions as possible until you run out of trace data (using <roffset> to specify regions). Or they return the number of regions you specify (using <rlimit>) ignoring any data beyond that.

- MINimum - returns the minimum data point (y value) for the specified region(s) of trace data. For I/Q trace data, the minimum magnitude of the I/Q pairs is returned.
- MAXimum - returns the maximum data point (y value) for the specified region(s) of trace data. For I/Q trace data, the maximum magnitude of the I/Q pairs is returned.
- MEAN - returns a single value that is the arithmetic mean of the data point values (in dB/ dBm) for the specified region(s) of trace data. For I/Q trace data, the mean of the magnitudes of the I/Q pairs is returned. See the following equations.

•

**NOTE**

If the original trace data is in dB, this function returns the arithmetic mean of those log values, not log of the mean power which is a more useful value. The mean of the log is the better measurement technique when measuring CW signals in the presence of noise. The mean of the power, expressed in dB, is useful in power measurements such as Channel Power. To achieve the mean of the power, use the RMS option.

Equation 1

Mean Value of Data Points for Specified Region(s)

$$\text{MEAN} = \frac{1}{n} \sum_{X_i \in \text{region}(s)} X_i$$

where  $X_i$  is a data point value, and  $n$  is the number of data points in the specified region(s).

Equation 2

Mean Value of I/Q Data Pairs for Specified Region(s)

$$\text{MEAN} = \frac{1}{n} \sum_{X_i \in \text{region}(s)} |X_i|$$

where  $|X_i|$  is the magnitude of an I/Q pair, and  $n$  is the number of I/Q pairs in the specified region(s).

- DMEan - returns a single value that is the mean power (in dB/ dBm) of the data point values for the specified region(s) of trace data. See the following equation:

Equation 3

DMEan Value of Data Points for Specified Region(s)

$$DME = 10 \times \log_{10} \left( \frac{1}{n} \sum_{X_i \in \text{region}(s)} 10^{\frac{X_i}{10}} \right)$$

- RMS - returns a single value that is the average power on a root-mean-squared voltage scale (arithmetic rms) of the data point values for the specified region(s) of trace data. See the following equation.

**NOTE** For I/Q trace data, the rms of the magnitudes of the I/Q pairs is returned. See the following equation. This function is very useful for I/Q trace data. However, if the original trace data is in dB, this function returns the rms of the log values which is not usually needed.

Equation 4

RMS Value of Data Points for Specified Region(s)

$$RMS = \sqrt{\frac{1}{n} \sum_{X_i \in \text{region}(s)} X_i^2}$$

where  $X_i$  is a data point value, and  $n$  is the number of data points in the specified region(s).

Equation 5

RMS Value of I/Q Data Pairs for Specified Region(s)

$$RMS = \sqrt{\frac{1}{n} \sum_{X_i \in \text{region}(s)} X_i X_i^*}$$

where  $X_i$  is the complex value representation of an I/Q pair,  $X_i^*$  its conjugate complex number, and  $n$  is the number of I/Q pairs in the specified region(s).

Once you have the rms value for a region of trace data (linear or I/Q), you may want to calculate the mean power. You must convert this rms value (peak volts) to power in dBm:

$$10 \times \log[10 \times (\text{rms value})^2]$$

- SAMPlE - returns the first data value (x,y pair) for the specified region(s) of trace data. For I/Q trace data, the first I/Q pair is returned.
- SDEViation - returns a single value that is the arithmetic standard deviation for the data point values for the specified region(s) of trace data. See the following equation.
- For I/Q trace data, the standard deviation of the magnitudes of the I/Q pairs is returned. See the following equation.

Equation 6

Standard Deviation of Data Point Values for Specified Region(s)

$$\text{SDEV} = \sqrt{\frac{1}{n} \sum_{X_i \in \text{region}(s)} (X_i - \bar{X})^2}$$

where  $X_i$  is a data point value,  $\bar{X}$  is the arithmetic mean of the data point values for the specified region (s), and  $n$  is the number of data points in the specified region(s).

$$\text{SDEV} = \sqrt{\frac{1}{n} \sum_{X_i \in \text{region}(s)} (|X_i| - \bar{X})^2}$$

where  $|X_i|$  is the magnitude of an I/Q pair,  $\bar{X}$  is the mean of the magnitudes for the specified region(s), and  $n$  is the number of data points in the specified region(s).

- PPHase - returns the x,y pairs of both rms power (dBm) and arithmetic mean phase (radian) for every specified region and frequency offset (Hz). The number of pairs is defined by the specified number of regions. This parameter can be used for I/Q vector (n=0) in Waveform (time domain) measurement and all parameters are specified by data point in PPHase.

The rms power of the specified region may be expressed as:

$$\text{Power} = 10 \times \log [10 \times (\text{RMS I/Q value})] + 10.$$

The RMS I/Q value (peak volts) is:

$$\sqrt{\frac{1}{n} \sum_{X_i \in \text{region}} X_i X_i^*}$$

where  $X_i$  is the complex value representation of an I/Q pair,  $X_i^*$  its conjugate complex number, and  $n$  is the number of I/Q pairs in the specified region.

The arithmetic mean phase of the specified region may be expressed as:

$$\frac{1}{n} \sum_{Y_i \in \text{region}} Y_i$$

where  $Y_i$  is the unwrapped phase of I/Q pair with applying frequency correction and  $n$  is the number of I/Q pairs in the specified region.

The frequency correction is made by the frequency offset calculated by the arithmetic mean of every specified region's frequency offset. Each frequency offset is calculated by the least square method against the unwrapped phase of I/Q pair.

Sample Trace Data - Constant Envelope

(See below for explanation of variables.)

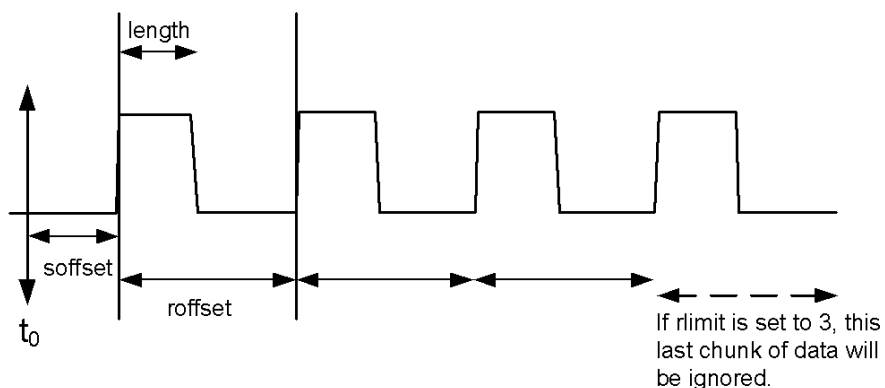

### Sample Trace Data - Not Constant Envelope

(See below for explanation of variables.)

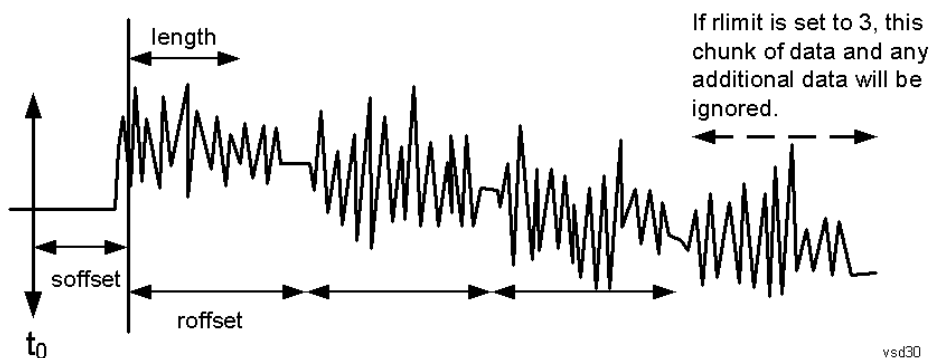

<soffset> - start offset is an optional real number. (It is in seconds for time-domain traces, and is a dimensionless index 0 to Npoints - 1, for frequency-domain traces). It specifies the amount of data at the beginning of the trace that will be ignored before the decimation process starts. It is the time or frequency change from the start of the trace to the point where you want to start using the data. The default value is zero.

<length> - is an optional real number. (It is in seconds for time-domain traces, and is a dimensionless index 0 to Npoints - 1, for frequency-domain traces). It defines how much data will be compressed into one value. This parameter has a default value equal to the current trace length.

<roffset> - repeat offset is an optional real number. (It is in seconds for time-domain traces, and is a dimensionless index 0 to Npoints - 1, for frequency-domain traces). It defines the beginning of the next field of trace elements to be compressed. This is relative to the beginning of the previous field. This parameter has a default value equal to the <length> variable. Note that this parameter is used for a completely different purpose when curve fitting (see CFIT above).

<rlimit> - repeat limit is an optional integer. It specifies the number of data items that you want returned. It will ignore any additional items beyond that number. You can use the Start offset and the Repeat limit to pick out exactly what part of the data you want to use. The default value is all the data.

## Calculate Peaks of Trace Data (Remote Command Only)

Returns a list of all the peaks for the currently selected measurement and sub-opcode [n]. The peaks must meet the requirements of the peak threshold and excursion values.

n = any valid sub-opcode for the current measurement. See the MEASure:<measurement> command description of your specific measurement for information on the data that can be returned.

The command can only be used with specific sub-opcodes with measurement results that are trace data. Both real and complex traces can be searched, but complex traces are converted to magnitude in dBm. In many measurements the sub-opcode n=0, is the raw trace data which cannot be searched for peaks. And Sub-opcode n=1, is often calculated results values which also cannot be searched for peaks.

This command uses the data setting specified by the FORMat:BORDER and FORMat:DATA commands and can return real or ASCII data. If the format is set to INT,32, it returns REAL,32 data.

The command has four types of parameters:

- Threshold (in dBm)
- Excursion (in dB)
- Sorting order (amplitude, frequency, time)
- Optional in some measurements: Display line use (all, > display line, < display line)

<b>Remote Command</b>	<p>For Swept SA measurement:</p> <pre>:CALCulate:DATA[1] 2 ... 6:PEAKs? &lt;threshold&gt;,&lt;excursion&gt;[,AMPLitude   FREQuency   TIME[,ALL   GTDLline   LTDLine]]</pre> <p>For most other measurements:</p> <pre>:CALCulate:DATA[1] 2 ... 6:PEAKs? &lt;threshold&gt;,&lt;excursion&gt;[,AMPLitude   FREQuency   TIME]</pre>
-----------------------	---------------------------------------------------------------------------------------------------------------------------------------------------------------------------------------------------------------------------------------------------------------------------------------------------------------------------------

<b>Example</b>	<p>Example for Swept SA measurement in Spectrum Analyzer Mode:</p> <p>CALC:DATA4:PEAK? -40, 10, FREQ, GTDL This will identify the peaks of trace 4 that are above -40 dBm, with excursions of at least 10 dB. The peaks are returned in order of increasing frequency, starting with the lowest frequency. Only the peaks that are above the display line are returned.</p> <p>Query Results 1:</p> <p>With FORMat:DATA REAL, 32 selected, it returns a list of floating-point numbers. The first value in the list is the number of peak points that are in the following list. A peak point consists of two values: a peak amplitude followed by its corresponding frequency (or time).</p> <p>If no peaks are found the peak list will consist of only the number of peaks, (0).</p>
----------------	-----------------------------------------------------------------------------------------------------------------------------------------------------------------------------------------------------------------------------------------------------------------------------------------------------------------------------------------------------------------------------------------------------------------------------------------------------------------------------------------------------------------------------------------------------------------------------------------------------------------------------------------------------------------------------------------------------------------------------------------------------------------------------------------

<b>Notes</b>	<p>&lt;n&gt; - is the trace that will be used</p> <p>&lt;threshold&gt; - is the level below which trace data peaks are ignored. Note that the threshold value is required and is always used as a peak criterion. To effectively disable the threshold criterion for this command, provide a substantially low threshold value such as -200 dBm. Also note that the threshold value used in this command is independent of and has no effect on the threshold value stored under the Peak Criteria menu.</p> <p>&lt;excursion&gt; - is the minimum amplitude variation (rise and fall) required for a signal to be identified as peak. Note that the excursion value is required and is always used as a peak criterion. To effectively disable the excursion criterion for this command, provide the minimum value of 0.0 dB. Also note that the excursion value used in this command is independent of and has no effect on the</p>
--------------	---------------------------------------------------------------------------------------------------------------------------------------------------------------------------------------------------------------------------------------------------------------------------------------------------------------------------------------------------------------------------------------------------------------------------------------------------------------------------------------------------------------------------------------------------------------------------------------------------------------------------------------------------------------------------------------------------------------------------------------------------------------------------------------------------------------------------------------------------------------------------------------------------------------------------------------

---

excursion value stored under the Peak Criteria menu.

Values must be provided for threshold and excursion. The sorting and display line parameters are optional (defaults are AMPLitude and ALL).

Note that there is always a Y-axis value for the display line, regardless of whether the display line state is on or off. It is the current Y-axis value of the display line which is used by this command to determine whether a peak should be reported

Sorting order:

AMPLitude - lists the peaks in order of descending amplitude, with the highest peak first (default if optional parameter not sent)

FREQuency - lists the peaks in order of occurrence, left to right across the x-axis.

TIME - lists the peaks in order of occurrence, left to right across the x-axis.

Peaks vs. Display Line:

ALL - lists all of the peaks found (default if optional parameter not sent).

GTDLine (greater than display line) - lists all of the peaks found above the display line.

LTDLine (less than display line) - lists all of the peaks found below the display line.

---

Initial S/W Revision	Prior to A.02.00
----------------------	------------------

---

### Hardware-Accelerated Fast Power Measurement (Remote Command Only)

The Fast Power option (FP2) enables very fast channel power measurements for instruments with the prerequisite hardware (DP2 and/or B40). It accomplishes this by performing real-time overlapped FFTs at the hardware layer, using software for basic post-processing before returning the result to the user. The upshot of this approach is improved throughput for user applications that require many sequential power measurements.

The analysis bandwidth of FP2 is limited by the licenses in the instrument, but its maximum overall analysis bandwidth per acquisition is 40 MHz.

FP2 is remote-only, which means the instrument does not switch to any particular mode or measurement. FP2 commands can be sent while another application is in use on the front panel.

Each Fast Power measurement can be predefined using an array index, and up to 1,000 measurements can be stored. In the following documentation, instances of [1,2,...,999] can be substituted with a particular measurement index, e.g. CALC:FPOW:POW1?, CALC:FPOW:POW2?, CALC:FPOW:POW134?. In this way, power measurements can be defined one time in a batch, and then executed multiple times without having to redefine them, similar to “list mode” on other measurements.

In addition to basic channel power measurements, there are a number of other measurement “functions” for each channel, including peak power, peak frequency, and power spectral density. See the Function parameter for more information.

### Reset Fast Power Measurement (Remote Command Only)

Resets the measurement configuration to the defaults.

---

<b>Mode</b>	All
<b>Remote Command</b>	:CALCulate:FPOWer:POWer [1, 2, ..., 999] :RESet
<b>Example</b>	:CALC:FPOW:POW1:RES

---

Notes	Option FP2 is required.
Initial S/W Revision	A.14.00

### Define Fast Power Measurement (Remote Command Only)

Fast Power acquisitions are configured using the DEFine command. This command accepts a comma-delimited string of configuration parameters and their appropriate values, which are all specified in the subsection below.

Mode	All
<b>Remote Command</b>	:CALCulate:FPOWer:POWer[1,2,...,999]:DEFine "configuration string"
<b>Example</b>	:CALC:FPOW:POW1:DEF "CenterFrequency=2e9, AcquisitionTime=0.005"
Notes	See below for a list of measurement variables that can be defined in the configuration string.
Initial S/W Revision	A.14.00

### Acquisition Time

Example	CALC:FPOW:POW1:DEF "AcquisitionTime=0.002"
Notes	The acquisition time parameter sets the time in which the entire spectrum is measured. An increase in the acquisition time yields an improvement in measurement repeatability.
Preset	0.001 s
Range	0 s to 1 s
Default Unit	Time (s)
Initial S/W Revision	A.14.00

### Center Frequency

Example	CALC:FPOW:POW1:DEF "CenterFrequency=2e9"
Notes	The center frequency parameter sets the frequency in which the measurement is centered around. The OffsetFrequency parameter is calculated relative to the center frequency.
Preset	1 GHz
Range	0 Hz to maximum instrument frequency
Default Unit	Frequency (Hz)
Initial S/W Revision	A.14.00

### DC Coupled

Example	CALC:FPOW:POW1:DEF "DCCoupled=True"
Notes	The DC coupled parameter allows the user to specify whether the DC blocking capacitor is utilized. Set parameter to true when measuring frequencies below 10 MHz.
Preset	False
Range	True (DC Coupled) or False (AC Coupled)
Default Unit	Boolean
Initial S/W Revision	A.14.00

### DetectorType

Example	CALC:FPOW:POW1:DEF "DetectorType=Peak"
Notes	Option FP2 is required. The detector type parameter allows the user to choose whether a RMS average or peak value is used during the measurement.
Preset	RmsAverage
Range	RmsAverage, Peak
Initial S/W Revision	A.14.00

### Do Noise Correction

Example	CALC:FPOW:POW1:DEF "DoNoiseCorrection=True"
Notes	When noise correction is enabled, the linear noise power contributed by the analyzer is subtracted from all measurements. This effectively lowers the noise floor of the analyzer. When noise correction is enabled, the first measurement for a given set of input parameters will take extra time. This is because the analyzer takes an extra acquisition with the RF input disconnected from the analyzer's front end to measure the noise of just the analyzer. The measured noise floor is stored in a cache so the noise acquisition will occur only once for the same state settings. In other words, if noise correction was turned on and the analyzer made an acquisition at frequency A, then frequency B, and back again to frequency A, the hidden initial noise floor acquisition would only occur for the first acquisition at frequency A and the cached noise floor would be used the second time frequency A was measured.
Preset	False
Range	True (enable noise correction) or False (disable noise correction)
Default Unit	Boolean
Initial S/W Revision	A.14.00



## Do Spur Suppression

Example	CALC:FPOW:POW1:DEF "DoSpurSuppression=True"
Notes	<p>When measuring very low level signals, or when large out-of-band inputs are input into the analyzer, sometimes unwanted spurs and residuals can appear in the measured spectrum. Spur suppression is a method to help minimize the levels of these internally generated spurs and residuals.</p> <p>When spur suppression is enabled, the analyzer will automatically take two acquisitions using two different internal analog LO frequencies. The FFT spectrums from both acquisitions are combined by taking the minimum power between both traces on a per FFT bin basis. External signals will have the same amplitude for both traces and therefore will return the expected amplitudes. However, low level spurs and residuals generated internally to the analyzer tend to move to different FFT bins depending on the internal analog LO frequency used, and therefore tend to be suppressed using this spur suppression method.</p> <p>Because two acquisitions, rather than a single acquisition, are made when spur suppression is enabled, the measurement time will always be slower when spur suppression is enabled.</p>
Preset	False
Range	True (enable spur suppression) or False (disable spur suppression)
Default Unit	Boolean
Initial S/W Revision	A.14.00

## Electronic Attenuator Bypass

Example	CALC:FPOW:POW1:DEF "ElecAttBypass =False"
Notes	The electronic attenuation bypass parameter allows the user to either utilize or bypass the electronic attenuator. The electronic attenuator is only available for frequencies up to 3.6 GHz. Set parameter to true when using frequencies above 3.6 GHz and set the parameter to false when using the preamp.
Preset	True
Range	True (bypass electronic attenuator) or False (use electronic attenuator)
Default Unit	Boolean
Initial S/W Revision	A.14.00

## Electronic Attenuation

Example	CALC:FPOW:POW1:DEF "ElecAttenuation=10"
Notes	<p>Option EA3 is required.</p> <p>The electronic attenuation value parameter sets the amount of electrical attenuation from 0 to 24 dB (1 dB steps).</p> <p>Set "ElecAttBypass=False" to make sure the electronic attenuator path is enabled.</p>
Preset	0 dB
Range	0 - 24 dB (1 dB steps)

Default Unit	dB
Initial S/W Revision	A.14.00

#### IF Gain

Example	CALC:FPOW:POW1:DEF "IFGain=10"
Notes	The IF gain parameter allows the user to specify the gain at the IF stage anywhere from -6 to 16 dB (1 dB steps). This is an advanced feature, and for most cases this should remain at its default value of 0 dB.
Preset	0 dB
Range	-6 - 16 dB (1 dB steps)
Default Unit	dB
Initial S/W Revision	A.14.00

#### IF Type

Example	CALC:FPOW:POW1:DEF "IFType=B25M"
Notes	The IF type parameter allows the user to select between different IF paths. For example, if the signal is less than 25 MHz wide, then the user can select the B25M path to take advantage of additional filtering on this analog IF path.
Preset	B40M
Range	B10M, B25M, B40M
Initial S/W Revision	A.14.00

#### Include Power Spectrum

Example	CALC:FPOW:POW1:DEF "IncludePowerSpectrum=True"
Notes	The power spectrum parameter allows the user to read data on the entire spectrum for diagnostic purposes. It is not recommended for production use. See CALC:FPOW:POW[n]:READ2? for details on the binary format of the response.
Preset	False
Range	True (return both channel power and full power spectrum) or False (returns only channel power)
Default Unit	Boolean
Initial S/W Revision	A.14.00

## Mechanical Attenuation

Example	CALC:FPOW:POW1:DEF "MechAttenuation=10"
Notes	The mechanical attenuation value parameter sets the amount of mechanical attenuation anywhere from 0 to 70 dB (2 dB steps).
Preset	0 dB
Range	0 – 70 dB (2 dB steps)
Default Unit	dB
Initial S/W Revision	A.14.00

## Preamp Mode

Example	CALC:FPOW:POW1:DEF "PreAmpMode=Low"
Notes	The license for the appropriate preamp is required. The preamp mode parameter specifies whether the preamps are being utilized. Low allows any preamps up to 3.6 GHz, and Full allows all licensed preamps. Set "ElecAttBypass=True" in order to utilize any preamps.
Preset	Off
Range	Off, Low, Full
Initial S/W Revision	A.14.00

## Resolution Bandwidth Mode

Example	CALC:FPOW:POW1:DEF "PreAmpMode=Low"
Notes	The resolution bandwidth mode parameter allows the user to choose whether the RBW filter is automatically or manually set. The BestSpeed value minimizes measurement time, while the Narrowest value minimizes RBW size (minimum of two FFT bins per RBW). To manually specify an RBW, set this parameter to Explicit, and set the ResolutionBW parameter to the desired value.
Preset	BestSpeed
Range	BestSpeed, Narrowest, Explicit
Initial S/W Revision	A.14.00

## Resolution Bandwidth

Example	CALC:FPOW:POW1:DEF "ResolutionBW=25e3"
Notes	The resolution bandwidth parameter sets the 3-dB bandwidth of the RBW filter. The ResolutionBWMode parameter must be set to Explicit in order to manually set the RBW.

Preset	0 Hz
Default Unit	Hz
Initial S/W Revision	A.14.00

#### Trigger Delay

Example	CALC:FPOW:POW1:DEF "TriggerDelay=0.025"
Notes	The trigger delay parameter sets the time after an external trigger is detected until the measurement is performed.
Preset	0 s
Range	0 - 1 s
Default Unit	Seconds
Initial S/W Revision	A.14.00

#### Trigger Level

Example	CALC:FPOW:POW1:DEF "TriggerLevel=2"
Notes	The trigger level parameter sets the voltage value at which an external trigger is detected.
Preset	1.2 V
Range	-5 to 5 V
Default Unit	Volts
Initial S/W Revision	A.14.00

#### Trigger Slope

Example	CALC:FPOW:POW1:DEF "TriggerSlope=Negative"
Notes	The trigger slope parameter indicates the direction of the edge trigger voltage for detection.
Preset	Positive
Range	Positive, Negative
Initial S/W Revision	A.14.00

## Trigger Source

Example	CALC:FPOW:POW1:DEF "TriggerSource=Ext1"
Notes	The trigger source parameter allows the user to choose between measurement's triggering freely or controlled by an external input. Ext1 and Ext2 correspond to Trigger 1 In and Trigger 2 In, respectively.
Preset	Free
Range	Free, Ext1, Ext2
Initial S/W Revision	A.14.00

## Trigger Timeout

Example	CALC:FPOW:POW1:DEF "TriggerTimeout=0.1"
Notes	The trigger timeout parameter sets the time in which the analyzer will wait for a trigger before automatically performing the measurement.
Preset	1 s
Range	0 – 1 s
Default Unit	Seconds
Initial S/W Revision	A.14.00

## Signal Input

Example	CALC:FPOW:POW1:DEF "SignalInput=Fp50MHzCW"
Notes	The signal input parameter allows the user to select between using the main RF input or the internal analyzer reference CW signal of 50 MHz.
Preset	FpMainRf
Range	FpMainRf, Fp50MHzCW
Initial S/W Revision	A.14.00

## Use Preselector

Example	CALC:FPOW:POW1:DEF "UsePreSelector=True"
Notes	The preselector parameter allows the user to either utilize or bypass the front end tunable filter at frequencies above 3.6 GHz. For frequencies below 3.6 GHz, the preselector is automatically bypassed, so you do not need to set this parameter to False in those cases.
Preset	False
Range	True (use preselector above 3.6 GHz), or False (preselector bypassed)

Default Unit	Boolean
Initial S/W Revision	A.14.00

#### Channel Bandwidth Array

Example	CALC:FPOW:POW1:DEF "Bandwidth=[3.84e6, 5e6, 3.84e6]"
Notes	The bandwidth parameter array defines the bandwidth of each channel that will be measured. All array parameters should have the same number of elements. Alternatively, if all the elements are the same value, a single number with no square brackets can be used to define the parameter.
Preset	[1e6]
Range	0 to 40 MHz
Default Unit	Hz
Initial S/W Revision	A.14.00

#### Channel Filter Type Array

Example	CALC:FPOW:POW1:DEF "FilterType=[RRC, IBW, RRC]"
Notes	The filter type parameter allows the user to choose between an integration bandwidth (IBW) filter or a root-raised-cosine (RRC) filter. The integration bandwidth filter weighs all frequencies within the bandwidth equally. The root-raised-cosine filter has an associated shape parameter, defined by the FilterAlpha parameter. All array parameters should have the same number of elements. Alternatively, if all the elements are the same value, a single value with no square brackets can be used to define the parameter.
Preset	[IBW]
Range	IBW, RRC
Initial S/W Revision	A.14.00

#### Channel Filter Alpha Array

Example	CALC:FPOW:POW1:DEF "FilterAlpha=[0.5, 0.0, 0.5]"
Notes	The filter alpha parameter allows the user to adjust the alpha value associated with the root-raised-cosine (RRC) filter type. Set FilterType to RRC in order to utilize this parameter. All array parameters should have the same number of elements. Alternatively, if all the elements are the same value, a single number with no square brackets can be used to define the parameter.
Preset	[0.22]
Range	0.0 - 1.0

Initial S/W Revision	A.14.00
-------------------------	---------

### Channel Measurement Function Array

Example	CALC:FPOW:POW1:DEF "Function=[BandPower, PeakPower, BandPower]"
Notes	<p>This parameter array defines what measurement is being made for each individually-specified channel:</p> <p>BandPower: Total power within the specified bandwidth of the channel (dBm)</p> <p>BandDensity: Total power density within the specified bandwidth of the channel (dBm/Hz)</p> <p>PeakPower: The peak power value within the specified bandwidth of the channel (dBm)</p> <p>PeakFrequency: The frequency which corresponds to the peak power value within the specified bandwidth of the channel. This frequency is relative to the center frequency (Hz)</p> <p>XdBBandwidth: The half power (-3.01 dB) bandwidth of the highest amplitude signal that resides within the channel (Hz), dB is configurable using XdBBandwidth parameter</p> <p>OccupiedBandwidth: The bandwidth at which 99% of the total power resides within the channel (Hz), percentage configurable using OccupiedBandwidthPercent parameter</p> <p>All array parameters should have the same number of elements. Alternatively, if all the elements are the same value, a single value with no square brackets can be used to define the parameter.</p>
Preset	[BandPower]
Range	BandPower, BandDensity, PeakPower, PeakFrequency, XdBBandwidth, OccupiedBandwidth
Initial S/W Revision	A.14.00

### Channel Offset Frequency Array

Example	CALC:FPOW:POW1:DEF "OffsetFrequency=[-5e6, 0, 5e6]"
Notes	<p>The offset frequency parameter array defines the difference between the center frequency to the center frequency of each channel.</p> <p>All array parameters should have the same number of elements.</p>
Preset	[0]
Range	0 to 20 MHz
Default Unit	Hz
Initial S/W Revision	A.14.00

### Channel Occupied Bandwidth Percent Array

Example	CALC:FPOW:POW1:DEF "OccupiedBandwidthPercent =[0.95, 0.95, 0.95]"
Notes	This parameter only applies for channels whose Function is set to OccupiedBandwidth. The occupied

	bandwidth percent parameter specifies the percent of total power in these channels. The valid range for this parameter is 0.0 to 1.0, where 1.0 represents 100%. The default for this parameter is 0.99, which will return the bandwidth that contains 99% of the total channel power.
Preset	[0.99]
Range	0 - 1.0
Initial S/W Revision	A.14.00

#### Channel x-dB Bandwidth Array

Example	CALC:FPOW:POW1:DEF " XdBBandwidth =[-6.02, -3.01, -1.0]"
Notes	This parameter only applies for channels whose Function is set to XdBBandwidth. The X dB bandwidth parameter is used to specify the power relative to the peak channel power over which the bandwidth is calculated. The parameter value must be a negative number.
Preset	[-3.01]
Range	-200 to 0 dB
Default Unit	dB
Initial S/W Revision	A.14.00

#### Define Fast Power Measurement Query (Remote Command Only)

The DEFine? command is used to retrieve a list of all defined parameters in an ASCII string format

M	All
o	
d	
e	
R	:CALCulate:FPOWer:POWer[1,2,...,999]:DEFine?
e	
m	
o	
t	
e	
C	
o	
m	
m	
a	
n	
d	
E	:CALC:FPOW:POW1:DEF?



x  
a  
m  
p  
l  
e

N This command query is used to retrieve a list of all defined parameters in an ASCII format.

O The following is an example of the returned results:

S "DCCoupled=False,ElecAttBypass=True,ElecAttenuation=0,IFGain=0,MechAttenuation=0,PreAmpMode=Off,PreSelectorOffset=0,UsePreSelector=False,ExternalReferenceFrequency=1000000,FrequencyReferenceSource=AutoExternalFrequencyReference,IFType=B40M,LOMode=SLW,SignalInput=FpMainRf,AcquisitionTime=0.001,CenterFrequency=100000000,ResolutionBW=0,ResolutionBWMode=BestSpeed,DetectorType=RmsAverage,Bandwidth=[1000000],OffsetFrequency=[0],Function=[BandPower],FilterType=[IBW],FilterAlpha=[0.22],OccupiedBandwidthPercent=[0.99],XdBBandwidth=[-3.01],DoNoiseCorrection=False,DoSpurSuppression=False,MeasurementMethod=HardwareFFT,IncludePowerSpectrum=False,TriggerDelay=0,TriggerLevel=1.2,TriggerSlope=Positive,TriggerSource=Free,TriggerTimeout=1"

I A.14.00

n  
i  
t  
i  
a  
l

S  
/  
W

R  
e  
v  
i  
s  
i  
o  
n

### Configure Fast Power Measurement (Remote Command Only)

The configure command begins hardware setup and returns immediately, with no acquisition made. This can be used in parallel with other hardware operations to effectively hide the hardware setup time.

Mode	All
<b>Remote Command</b>	:CALCulate:FPOWER:POWer[1,2,...,999]:CONFigure
<b>Example</b>	:CALC:FPOW:POW1:CONF
Notes	Option FP2 is required.
Initial S/W Revision	A.14.00

### Initiate Fast Power Measurement (Remote Command Only)

The INITiate command begins an acquisition and returns immediately. The results of the measurement can be retrieved using FETCh.

Mode	All
<b>Remote Command</b>	:CALCulate:FPOWER:POWER[1,2,...,999]:INITiate
<b>Example</b>	:CALC:FPOW:POW1:INIT
Notes	Option FP2 is required.
Initial S/W Revision	A.14.00

### Fetch Fast Power Measurement (Remote Command Only)

The FETCh command query is used to retrieve the results of an acquisition initiated by the INIT command. The returned results are in ASCII string format. The string begins and ends with quotation marks.

Mode	All
<b>Remote Command</b>	:CALCulate:FPOWER:POWER[1,2,...,999]:FETCh?
<b>Example</b>	:CALC:FPOW:POW1:FETC?
Notes	Option FP2 is required. Returns m comma-separated ASCII values, where m corresponds to the number of bandwidths defined. 1. Declared function return in the 1st specified channel 2. Declared function return in the 2nd specified channel ... m. Declared function return in the last specified channel The INIT and FETC? command sequence performs the same functionality of a single CALC:FPOW:POW[n]? query. Units of the returned values are dependent on the Function parameter for each channel.
Initial S/W Revision	A.14.00

### Execute Fast Power Measurement (Remote Command Only)

This command query is used as shorthand for an INIT command immediately followed by a FETC? command. The returned results are in ASCII string format. The string begins and ends with quotation marks.

Mode	All
<b>Remote Command</b>	:CALCulate:FPOWER:POWER[1,2,...,999]?
<b>Example</b>	:CALC:FPOW:POW1?

Notes	Option FP2 is required. See notes for Fast Power Fetch for return format.
Initial S/W Revision	A.14.00

### Binary Read Fast Power Measurement (Remote Command Only)

This command query is used as shorthand for an INIT command immediately followed by a FETC? command. The returned results are in a binary format.

Mode	All
<b>Remote Command</b>	:CALCulate:FPOWER:POWER[1,2,...,999]:READ? :CALCulate:FPOWER:POWER[1,2,...,999]:READ1?
<b>Example</b>	:CALC:FPOW:POW1:READ? :CALC:FPOW:POW1:READ1?
Notes	Option FP2 is required. Returns m 4 byte floating point binary values (Little-Endian), where m corresponds to the number of bandwidths defined.
Initial S/W Revision	A.14.00

### Diagnostic Binary Read Fast Power Measurement (Remote Command Only)

This command query is used as shorthand for an INIT command immediately followed by a FETC? command. The returned results are in a binary format. This command is used primarily for diagnostic purposes to test for ADC overloads and to visibly inspect the spectrum.

Mode	All
<b>Remote Command</b>	:CALCulate:FPOWER:POWER[1,2,...,999]:READ2?
<b>Example</b>	:CALC:FPOW:POW1:READ2?
Notes	Option FP2 is required. Note: Spectrum data is only returned if the IncludePowerSpectrum parameter is set to True. If IncludePowerSpectrum is False, the number of spectrum points will be zero (0). Units of the returned values are dependent on the Function parameter per channel (e.g. dBm for BandPower, Hz for PeakFrequency). Returns binary data (Little-Endian) that contains information on m amount of channels, along with ADC over range and full spectrum data. The following is the binary format of the response. Bandwidth Return Value 1. Number of channels specified, m [4 byte int] 2. Declared function result for the 1st specified channel [4 byte float]

---

	3. Declared function result for the 2nd specified channel [4 byte float]
	...
	(m + 1). Declared function result for the last (mth) specified channel [4 byte float]
	ADC Over Range
	1. ADC over-range occurred (1: true, 0: false) [2 byte short]
	Spectrum Data
	1. Number of points in the spectrum data, k [4 byte int]
	2. Start frequency of spectrum data (Hz) [8 byte double]
	3. Step frequency of spectrum data (Hz) [8 byte double]
	4. FFT bin at 1st point (dBm) [4 byte float]
	5. FFT bin at 2nd point (dBm) [4 byte float]
	...
	(k + 3). FFT bin at last (kth) point (dBm) [4 byte float]

---

Initial S/W Revision	A.14.00
-------------------------	---------

---

### Format Data: Numeric Data (Remote Command Only)

This command specifies the format of the trace data input and output. It specifies the formats used for trace data during data transfer across any remote port. It affects only the data format for setting and querying trace data for the :TRACe[:DATA], TRACe[:DATA]?, :CALCulate:DATA[n]? and FETCh:SANalyzer [n]? commands and queries.

---

<b>Remote Command</b>	:FORMat [:TRACe] [:DATA] ASCii   INTeger, 32   REAL, 32   REAL, 64 :FORMat [:TRACe] [:DATA] ?
<b>Notes</b>	The query response is: ASCii: ASC,8 REAL,32: REAL,32 REAL,64: REAL,64 INTeger,32: INT,32 When the numeric data format is REAL or ASCii, data is output in the current Y Axis unit. When the data format is INTeger, data is output in units of m dBm (.001 dBm). The INT,32 format returns binary 32-bit integer values in internal units (m dBm), in a definite length block.
<b>Dependencies</b>	Sending a data format spec with an invalid number (for example, INT,48) generates no error. The analyzer simply uses the default (8 for ASCii, 32 for INTeger, 32 for REAL). Sending data to the analyzer which does not conform to the current FORMat specified, results in an error. Sending ASCII data when a definite block is expected generates message -161 "Invalid Block Data" and sending a definite block when ASCII data is expected generates message -121 "Invalid Character in Number".
<b>Preset</b>	ASCii
<b>Backwards Compatibility</b>	Note that the INT,32 format is only applicable to the command, TRACe:DATA. This preserves

---

Notes	backwards compatibility for the Swept SA measurement. For all other commands/queries which honor FORMat:DATA, if INT,32 is sent the analyzer will behave as though it were set to REAL,32.
Initial S/W Revision	Prior to A.02.00

The specs for each output type follow:

ASCIi - Amplitude values are in ASCII, in the current Y Axis Unit, one ASCII character per digit, values separated by commas, each value in the form:

SX.YYYYYEsZZ

Where:

S = sign (+ or -)

X = one digit to left of decimal point

Y = 5 digits to right of decimal point

E = E, exponent header

s = sign of exponent (+ or -)

ZZ = two digit exponent

REAL,32 - Binary 32-bit real values in the current Y Axis Unit, in a definite length block.

REAL,64 - Binary 64-bit real values in the current Y Axis Unit, in a definite length block.

### Format Data: Byte Order (Remote Command Only)

This command selects the binary data byte order for data transfer and other queries. It controls whether binary data is transferred in normal or swapped mode. This command affects only the byte order for setting and querying trace data for the :TRACe[:DATA], TRACe[:DATA]? , :CALCulate:DATA[n]? and FETCh:SANalyzer[n]? commands and queries.

By definition any command that says it uses FORMat:DATA uses any format supported by FORMat:DATA.

The NORMal order is a byte sequence that begins with the most significant byte (MSB) first, and ends with the least significant byte (LSB) last in the sequence: 1|2|3|4. SWAPped order is when the byte sequence begins with the LSB first, and ends with the MSB last in the sequence: 4|3|2|1.

<b>Remote Command</b>	:FORMat:BORDER NORMal   SWAPped :FORMat:BORDER?
Preset	NORMal
Initial S/W Revision	Prior to A.02.00

## Meas Setup

Displays the setup menu for the currently selected measurement.

Key Path	Front-panel key
Initial S/W Revision	Prior to A.02.00

### Avg/Hold Num

Toggles averaging On or Off in addition to enabling you to set the number of measurement averages used to calculate the measurement result. The average is displayed at the end of each sweep. After the specified number of average counts, the average mode (termination control) setting determines the average action.

In the remote mode, use the Average State command to turn averaging on or off.

Key Path	Meas Setup
Mode	SA, WCDMA, C2K, WIMAX OFDMA, TD-SCDMA, 1xEVDO, DTMB (CTTB), DVB-T/H, ISDB-T, CMMB, LTE, LTE-TDD, Digital Cable TV, WLAN, MSR, LTEAFDD, LTEATDD
Remote Command	[:SENSe]:SEMAsk:AVERAge:COUNT <integer> [:SENSe]:SEMAsk:AVERAge:COUNT? [:SENSe]:SEMAsk:AVERAge[:STATe] ON OFF 1 0 [:SENSe]:SEMAsk:AVERAge[:STATe]?
Example	SEM:AVER:COUN 100 SEM:AVER:COUN? SEM:AVER ON SEM:AVER?
Notes	You must be in the mode that includes SEM measurement to use this command. Use :INSTrument:SElect to set the mode.
Preset	10 OFF
State Saved	Saved in instrument state.
Min	1
Max	10000
Initial S/W Revision	Prior to A.02.00
Modified at S/W Revision	A.02.00, A.03.00

### Meas Type

Accesses a menu that enables you to select one of the following measurement reference types:

- Total Pwr Ref – Sets the reference to the total carrier power and the measured data is shown in dBc and dBm.
- PSD Ref – Sets the reference to the mean power spectral density of the carrier and the measured data is shown in dB and dBm/Hz.
- Spectrum Peak Ref – Sets the reference to the spectrum peak power of the carrier and the measured data is shown in dB and dBm.

Key Path	Meas Setup
Mode	SA, WCDMA, C2K, WIMAX OFDMA, TD-SCDMA, 1xEVDO, DTMB (CTTB), DVB-T/H, ISDB-T, CMMB, LTE, LTE-TDD, Digital Cable TV, WLAN, MSR, LTEAFDD, LTEATDD
<b>Remote Command</b>	[ :SENSe ] :SEMask:TYPE PSDRef TPRef SPRef [ :SENSe ] :SEMask:TYPE?
<b>Example</b>	SEM:TYPE PSDR SEM:TYPE?
Notes	You must be in the mode that includes SEM measurement to use this command. Use :INSTrument:SElect to set the mode.
Preset	SA, , WCDMA, , C2K, , TD-SCDMA, , 1xEVDO, , DTMB (CTTB), , DVB-T/H, , ISDB-T, , CMMB, , LTE, , LTE-TDD, , Digital Cable TV, , MSR, , LTEAFDD, , LTEATDD: TPRef WIMAX OFDMA, WLAN: SPRef
State Saved	Saved in instrument state.
Range	Total Pwr Ref PSD Ref Spectrum Peak Ref
Initial S/W Revision	Prior to A.02.00
Modified at S/W Revision	A.02.00, A.03.00

## Ref Channel

Accesses a menu that enables you to set up the measurement parameters used to calculate the power in the reference channel.

Key Path	Meas Setup
Initial S/W Revision	Prior to A.02.00

## Integ BW

Specifies the integration bandwidth used to calculate the power in the reference channel.

Key Path	Meas Setup, Ref Channel
Mode	SA, WCDMA, C2K, WIMAX OFDMA, TD-SCDMA, 1xEVDO, DTMB (CTTB), DVB-T/H, ISDB-T, CMMB, LTE, LTE-TDD, Digital Cable TV, WLAN
<b>Remote Command</b>	[ :SENSe ] :SEMask:BANDwidth[1] 2:INTEgration <bandwidth> [ :SENSe ] :SEMask:BANDwidth[1] 2:INTEgration?

<b>Example</b>	SEM:BAND:INT 10 MHz SEM:BAND:INT?
<b>Notes</b>	10% . 100% of Channel Span Parameter Value Bandwidth sub op code, 1 is for BTS, 2 for MS. Default is BTS. You must be in the mode that includes SEM measurement to use this command. Use :INSTrument:SElect to set the mode.
<b>Dependencies</b>	For MSR and LTE-Advanced FDD/TDD mode, this key is blank.
<b>Couplings</b>	Cannot be higher than the channel Span. If lower than 1/10 of channel Span, then the channel Span is reduced to be 10 times the Integ BW.
<b>Preset</b>	SA: 3.84 MHz WCDMA: 3.84 MHz 3.84 MHz C2K: 1.23 MHz 1.23 MHz WIMAX OFDMA: 10 MHz 10 MHz TD-SCDMA: 1.28 MHz 1.28 MHz 1xEVDO: 1.23MHz DTMB (CTTB): 7.56MHz DVB-T/H: 7.61MHz ISDB-T: 5.6MHz CMMB: 7.512MHz LTE: 4.515MHz 4.5MHz LTETDD: 4.515MHz 4.5MHz Digital Cable TV: 6.9MHz WLAN: if Radio Std is 802.11a/g(OFDM/DSSS-OFDM)/802.11n(20 MHz)/ 802.11ac (20 MHz): 18 MHz if Radio Std is 802.11b/g(DSSS/CCK/PBCC): 22 MHz if Radio Std is 802.11n(40MHz)/ 802.11ac (40 MHz): 38 MHz if Radio Std is 802.11ac (80 MHz): 78 MHz if Radio Std is 802.11ac (160 MHz): 158 MHz if Radio Std is 802.11ac (80 MHz + 80 MHz): 78 MHz
<b>State Saved</b>	Saved in instrument state.
<b>Min</b>	1 kHz
<b>Max</b>	645 MHz
<b>Initial S/W Revision</b>	Prior to A.02.00
<b>Modified at S/W Revision</b>	A.02.00, A.03.00

## Span

Specifies the span used to calculate the power in the reference channel.

<b>Key Path</b>	Meas Setup, Ref Channel
-----------------	-------------------------



Mode	SA, WCDMA, C2K, WIMAX OFDMA, TD-SCDMA, 1xEVDO, DTMB (CTTB), DVB-T/H, ISDB-T, LTE, LTETDD, CMMB, Digital Cable TV, WLAN
Remote Command	[ :SENSe ] :SEMAsk:FREQuency [ 1 ]   2 :SPAN <freq> [ :SENSe ] :SEMAsk:FREQuency [ 1 ]   2 :SPAN?
Example	SEM:FREQ:SPAN 3MHz SEM:FREQ:SPAN?
Notes	Frequency sub op code, 1 is for BTS, 2 for MS. Default is BTS. You must be in the mode that includes SEM measurement to use this command. Use :INSTrument:SElect to set the mode.
Dependencies	For MSR and LTE-Advanced FDD/TDD mode, this key is blank.
Couplings	Range 1 kHz to 50 MHz (although restricted by Integ BW). If you set the channel Span lower than channel Integ BW, they will both track each other. As you increase the channel Span, the Integ BW will also increase if it is less than 1/10 of the channel Span. For WLAN 802.11ac (80 + 80 MHz), the channel span is coupled with the difference between the center frequencies of the two carriers. When the difference is either less than 80 MHz or greater than 565 MHz, a “setting conflict” error message is displayed. Chan Span = Carrier Spacing + Chan IntegBW;
Preset	SA: 5.0 MHz WCDMA: 5.0 MHz 5.0 MHz C2K: 1.25 MHz 1.25 MHz WIMAX OFDMA: 10 MHz 10 MHz TD-SCDMA: 1.6 MHz 1.6 MHz 1xEVDO: 1.25 MHz DTMB (CTTB): 10 MHz DVB-T/H: 10 MHz ISDB-T: 8 MHz CMMB: 10 MHz LTE: 5 MHz LTETDD: 5 MHz Digital Cable TV: 10 MHz WLAN: if Radio Std is 802.11a/g(OFDM/DSSS-OFDM)/802.11n(20 MHz)/ 802.11ac (20 MHz): 18 MHz if Radio Std is 802.11b/g(DSSS/CCK/PBCC): 22 MHz if Radio Std is 802.11n(40MHz)/ 802.11ac (40 MHz): 38 MHz if Radio Std is 802.11ac (80 MHz): 78 MHz if Radio Std is 802.11ac (160 MHz): 158 MHz if Radio Std is 802.11ac (80 MHz + 80 MHz): 240 MHz
State Saved	Saved in instrument state.
Min	1 kHz
Max	645 MHz

Initial S/W Revision	Prior to A.02.00
Modified at S/W Revision	A.02.00, A.03.00

## Sweep Time

Sets the sweep time used to calculate the power in the reference channel. Sweep Time can be set manually or put in auto mode.

Key Path	Meas Setup, Ref Channel
Mode	SA, WCDMA, C2K, WIMAX OFDMA, TD-SCDMA, 1xEVDO, DTMB (CTTB), DVB-T/H, ISDB-T, CMMB, LTE, LTEFDD, Digital Cable TV, WLAN, MSR, LTEAFDD, LTEATDD
Remote Command	[:SENSe]:SEMAsk:SWEep[1] 2:TIME <time> [:SENSe]:SEMAsk:SWEep[1] 2:TIME? [:SENSe]:SEMAsk:SWEep[1] 2:TIME:AUTO OFF 0 ON 1 [:SENSe]:SEMAsk:SWEep[1] 2:TIME:AUTO?
Example	SEM:SWE:TIME 9ms SEM:SWE:TIME? SEM:SWE:TIME:AUTO OFF SEM:SWE:TIME:AUTO?
Notes	Sub op code, 1 is for BTS, 2 for MS. Default is BTS. You must be in the mode that includes SEM measurement to use this command. Use :INSTrument:SElect to set the mode.
Couplings	When the time is set manually, Auto is set to OFF. Value is coupled with Channel Detector selection, Channel Resolution BW, Channel Video BW if the state is Auto. When set to Auto, the Sweep Time is automatically calculated
Preset	Automatically calculated ON
State Saved	Saved in instrument state.
Min	1 ms
Max	4000 s
Initial S/W Revision	Prior to A.02.00
Modified at S/W Revision	A.02.00, A.03.00

## Power Ref (for the modes except MSR and LTE-Advanced FDD/TDD)

Sets the power reference in the carrier that will be used to compute the relative values for the offsets.

Key Path	Meas Setup, Ref Channel
Initial S/W Revision	Prior to A.02.00

### Total Power

Sets the power in the carrier (ref channel) that is used to compute the relative power values for the offsets. When the state is set to auto, this value is set to the measured carrier reference power. When set to manual, the result takes on the last measured value, or can be manually entered.

For WLAN 802.11ac (80 MHz + 80 MHz), the higher of the power readouts of the two carriers is used for computing the relative power values for the offset.

Key Path	Meas Setup, Ref Channel, Power Ref
Mode	SA, WCDMA, C2K, WIMAX OFDMA, TD-SCDMA, 1xEVDO, DTMB (CTTB), DVB-T/H, ISDB-T, CMMB, LTE, LTE-TDD, Digital Cable TV, WLAN, MSR, LTEAFDD, LTEATDD
Remote Command	[:SENSe]:SEMAsk:CARRier[:POWer] <real> [:SENSe]:SEMAsk:CARRier[:POWer]? [:SENSe]:SEMAsk:CARRier:AUTO[:STATe] OFF ON 1 0 [:SENSe]:SEMAsk:CARRier:AUTO[:STATe]?
Example	SEM:CARR 100dBm SEM:CARR? SEM:CARR:AUTO OFF SEM:CARR:AUTO?
Notes	The min and max values given are for Meas Type = Total Pwr Ref. You must be in the mode that includes SEM measurement to use this command. Use :INSTrument:SELEct to set the mode.. This BAF SCPI command is available in all the Meas Type case. This BAF SCPI command is not available in MSR and LTE-Advanced FDD/TDD mode.
Dependencies	This "Total Power Ref" parameter is coupled with the "Meas Type" parameter. The softkey is active when Meas Type is set to Total Power Ref. Otherwise, it is grayed out.
Preset	Measured carrier reference power
State Saved	Saved in instrument state.
Min	-200 dBm
Max	200 dBm
Initial S/W Revision	Prior to A.02.00
Modified at S/W Revision	A.02.00, A.03.00

### PSD

Sets the power spectral density in the carrier that is used to compute the relative power spectral density values for the offsets when Meas Type is set to PSD Ref. When the state is set to auto, this will be set to

the measured carrier power spectral density.

For WLAN 802.11ac (80 MHz + 80 MHz), the higher of the power density readouts of the two carriers is used for computing the relative PSD values for the offset.

<b>Key Path</b>	Meas Setup, Ref Chan, Power Ref
<b>Mode</b>	SA, WCDMA, C2K , WIMAX OFDMA, TD-SCDMA, 1xEVDO, DTMB (CTTB), DVB-T/H, ISDB-T, CMMB, LTE, LTE-TDD, Digital Cable TV, WLAN, MSR, LTEAFDD, LTEATDD
<b>Remote Command</b>	[ :SENSe ] :SEMAsk:CARRier:CPsD <real> [ :SENSe ] :SEMAsk:CARRier:CPsD?
<b>Example</b>	SEM:CARR:CPsD -80 SEM:CARR:CPsD?
<b>Notes</b>	Although the default value is defined, the value is recalculated by the measurement result just after completing the measurement. Carrier sub op code. 1 for BTS, 2 for MS. Default is BTS. You must be in the mode that includes SEM measurement to use this command. Use :INSTrument:SElect to set the mode.
<b>Dependencies</b>	See Couplings
<b>Couplings</b>	This "PSD" parameter is coupled with the "Meas Type" parameter. The key will be active if the Meas Type is set to PSD. Otherwise, it is grayed out.
<b>Preset</b>	Measured carrier PSD reference power
<b>State Saved</b>	Saved in instrument state.
<b>Min</b>	-200
<b>Max</b>	200
<b>Initial S/W Revision</b>	Prior to A.02.00
<b>Modified at S/W Revision</b>	A.02.00, A.03.00

## Spectrum Peak

Sets the spectrum peak power in the carrier that is used to compute the relative power spectral density values for the offsets when Meas Type is set to Spectrum Peak. When the state is set to auto, this is set to the measured carrier spectrum peak power. When set to manual, the result takes on the last measured value, or can be manually entered

<b>Key Path</b>	Meas Setup, Ref Channel, Power Ref
<b>Mode</b>	SA, WCDMA, C2K , WIMAX OFDMA, TD-SCDMA, 1xEVDO, DTMB (CTTB), DVB-T/H, ISDB-T, CMMB, LTE, LTE-TDD, Digital Cable TV, WLAN
<b>Remote Command</b>	[ :SENSe ] :SEMAsk:CARRier:PEAK[:POWer] <real> [ :SENSe ] :SEMAsk:CARRier:PEAK[:POWer] ?
<b>Example</b>	SEM:CARR:PEAK -80 SEM:CARR:PEAK:POWER?
<b>Notes</b>	Although the default value is defined, the value is recalculated by the measurement result just after completing the measurement.

	Carrier sub op code. 1 for BTS, 2 for MS. Default is BTS. You must be in the mode that includes SEM measurement to use this command. Use :INSTrument:SElect to set the mode.
Dependencies	See Couplings
Couplings	This "Spectrum Peak Ref" parameter is coupled with the "Meas Type" parameter. This softkey is active when the "Meas Type" is set to "Spectrum Peak Ref". Otherwise, grayout.
Preset	Measured carrier Spectrum Peak reference power
State Saved	Saved in instrument state.
Min	-200
Max	200
Initial S/W Revision	Prior to A.02.00
Modified at S/W Revision	A.02.00, A.03.00

## Res BW

Sets the resolution bandwidth used to calculate the power in the reference channel. The Channel Resolution BW can be set manually or put in to auto mode.

MSR Auto RBW:

In the MSR resolution bandwidth is predefined for each radio format. When carriers are configured with multiple radio formats, the narrowest RBW is selected.

LTE	1.4 MHz	13
	3 MHz	27
	5 MHz	47
	10 MHz	91
	15 MHz	150
	20 MHz	180
W-CDMA		75
GSM		30

In LTE-Advanced FDD/TDD, the resolution bandwidth is predefined based on the corresponding bandwidth of the single LTE carrier, which is listed above. When ResBW mode is Auto, the narrowest RBW is selected.

Key Path	Meas Setup, Ref Channel
Mode	SA, WCDMA, C2K, WIMAX OFDMA, TD-SCDMA, 1xEVDO, DTMB (CTTB), DVB-T/H, ISDB-T, CMMB, LTE, LTE-TDD, Digital Cable TV, WLAN, MSR, LTEAFDD, LTEATDD
Remote Command	[ :SENSe ] :SEMAsk:BANDwidth[1]   2 [ :RESolution ] <bandwidth> [ :SENSe ] :SEMAsk:BANDwidth[1]   2 [ :RESolution ] ? [ :SENSe ] :SEMAsk:BANDwidth[1]   2 [ :RESolution ] :AUTO OFF   ON   1   0

	<code>[ :SENSe ] :SEMAsk :BANDwidth [ 1 ]   2 [ :RESolution ] :AUTO?</code>
<b>Example</b>	SEM:BAND 100 kHz SEM:BAND? SEM:BAND:AUTO ON SEM:BAND:AUTO?
<b>Notes</b>	Bandwidth sub op code, 1 is for BTS, 2 for MS. Default is BTS. You must be in the mode that includes SEM measurement to use this command. Use :INSTrument:SElect to set the mode.
<b>Couplings</b>	When Res BW is set manually, Channel Resolution BW Mode is set to Manual. Value is coupled with Channel Detector selection, Channel Sweep Time, Channel Video BW. When set to Auto, the resolution bandwidth is automatically calculated.
<b>Preset</b>	SA: 100 kHz WCDMA: 75 kHz C2K: 24 kHz WIMAX OFDMA: 100 kHz TD-SCDMA: 30 kHz 1xEVDO: 30.0 KHz DTMB (CTTB): 3.9 kHz DVB-T/H: 3.9 kHz ISDB-T: 10 kHz CMMB: 3.9 kHz LTE, , LTETDD, , MSR, , LTEAFDD, , LTEATDD:Auto (47 kHz) Digital Cable TV: 3.9 kHz WLAN: 100 kHz ON
<b>State Saved</b>	Saved in instrument state.
<b>Min</b>	1 Hz
<b>Max</b>	8 MHz
<b>Backwards Compatibility SCPI</b>	<code>[ :SENSe ] :SEMAsk :BWIDth [ 1 ]   2 [ :RESolution ]</code>
<b>Initial S/W Revision</b>	Prior to A.02.00
<b>Modified at S/W Revision</b>	A.02.00, A.03.00

## Video BW

Sets the video bandwidth used to calculate the power in the reference channel. The Channel Video BW can be set manually or put in to auto mode.

<b>Key Path</b>	Meas Setup, Ref Channel
<b>Mode</b>	SA, WCDMA, C2K, WIMAX OFDMA, TD-SCDMA, 1xEVDO, DTMB (CTTB), DVB-T/H, ISDB-T, CMMB,

	LTE, LTE-TDD, Digital Cable TV, WLAN, MSR, LTEAFDD, LTEATDD
<b>Remote Command</b>	<pre>[ :SENSe] :SEMask:BAWidth[1]  2:VIDeo &lt;bandwidth&gt; [ :SENSe] :SEMask:BAWidth[1]  2:VIDeo? [ :SENSe] :SEMask:BAWidth[1]  2:VIDeo:AUTO OFF ON 1 0 [ :SENSe] :SEMask:BAWidth[1]  2:VIDeo:AUTO?</pre>
<b>Example</b>	<pre>SEM:BAW:VID 100 kHz SEM:BAW:VID? SEM:BAW:VID:AUTO ON SEM:BAW:VID:AUTO?</pre>
<b>Notes</b>	<p>Bandwidth sub op code, 1 is for BTS, 2 for MS. Default is BTS.</p> <p>You must be in the mode that includes SEM measurement to use this command. Use :INSTrument:SElect to set the mode.</p>
<b>Couplings</b>	<p>When Video BW is set manually, Channel Video BW Mode is set to MANual</p> <p>Value is coupled with Channel Detector selection, Channel Sweep Time, Channel Resolution BW.</p> <p>When set to Auto, the video bandwidth is automatically calculated.</p>
<b>Preset</b>	<pre>SA: 100 kHz WCDMA: 75 kHz C2K: 24 kHz WIMAX OFDMA: 30 kHz TD-SCDMA: 300 kHz 1xEVDO: 300.0 kHz DTMB (CTTB): 39 kHz DVB-T/H: 39 kHz ISDB-T: 1 kHz CMMB: 39 kHz LTE, MSR, LTEAFDD, LTEATDD: Auto LTE-TDD: Auto Digital Cable TV: 39 kHz WLAN: Auto ON</pre>
<b>State Saved</b>	Saved in instrument state.
<b>Min</b>	1 Hz
<b>Max</b>	50 MHz
<b>Backwards Compatibility SCPI</b>	[ :SENSe] :SEMask:BWIDth[1]  2:VIDeo
<b>Initial S/W Revision</b>	Prior to A.02.00
<b>Modified at S/W Revision</b>	A.02.00, A.03.00

## VBW/RBW

Sets the Video BW/Resolution BW Ratio to calculate the Channel Resolution BW and Channel Video BW. The VBW/RBW Ratio can be set manually or put in to auto mode.

<b>Key Path</b>	Meas Setup, Ref Channel
<b>Mode</b>	SA, WCDMA, C2K, WIMAX OFDMA, TD-SCDMA mode, 1xEVDO, DTMB (CTTB), DVB-T/H, ISDB-T, CMMB, LTE, LTETDD, Digital Cable TV, WLAN, MSR, LTEAFDD, LTEATDD
<b>Remote Command</b>	[:SENSe]:SEMAsk:BAWdwidth[1] 2:VIDeo:RATio <real> [:SENSe]:SEMAsk:BAWdwidth[1] 2:VIDeo:RATio [:SENSe]:SEMAsk:BAWdwidth[1] 2:VIDeo:RATio:AUTO OFF ON 1 0 [:SENSe]:SEMAsk:BAWdwidth[1] 2:VIDeo:RATio:AUTO?
<b>Example</b>	SEM:BAND:VID:RAT 0.1 SEM:BAND:VID:RAT? SEM:BAND:VID:RAT:AUTO ON SEM:BAND:VID:RAT:AUTO?
<b>Notes</b>	Bandwidth sub op code, 1 is for BTS, 2 for MS. Default is BTS. You must be in the mode that includes SEM measurement to use this command. Use :INSTRument:SELEct to set the mode.
<b>Couplings</b>	When Video BW/Res BW is set manually, Channel VBW/RBW Ratio Mode is set to Manual When set to Auto, the VBW/RBW Ratio is automatically calculated.
<b>Preset</b>	SA, WCDMA, C2K: 1.0 WIMAX OFDMA: 0.3 TD-SCDMA: 10 1xEVDO: 10.0 DTMB (CTTB): 10 DVB-T/H: 10 ISDB-T: 0.1 CMMB: 10 LTE, MSR: Auto LTEAFDD,LTEATDD:Auto LTETDD: Auto Digital Cable TV: 10 WLAN: Auto ON
<b>State Saved</b>	Saved in instrument state.
<b>Min</b>	0.00001
<b>Max</b>	3000000
<b>Backwards Compatibility SCPI</b>	[:SENSe]:SEMAsk:BWIDth[1] 2:VIDeo:RATio
<b>Initial S/W Revision</b>	Prior to A.02.00
<b>Modified at S/W Revision</b>	A.02.00, A.03.00



## Offset/Limits

Accesses a menu that enables you to set up the measurement parameters for offset pairs. For example, you can assign the start and stop frequencies, select the resolution bandwidth, and set the sweep time. When in the MSR and LTE-Advanced FDD/TDD mode, the softkey label changes to Outer Offset/Limits.

Key Path	Meas Setup
Initial S/W Revision	Prior to A.02.00
Modified at S/W Revision	A.14.00

## Select Offset

Selects the offset (upper and lower) and displays the memory selection menu that enables you to store a set of parameter values for the offset, such as Start Freq, Stop Freq, Sweep Time, Res BW, Meas BW, Abs Start, and Abs Stop. Only one selection at a time is shown on this menu key label.

Key Path	Meas Setup, Offset/Limits
Mode	SA, WCDMA, C2K, WIMAX OFDMA, TD-SCDMA, 1xEVDO, DTMB (CTTB), DVB-T/H, ISDB-T, CMMB, LTE, LTE-TDD, Digital Cable TV, WLAN, MSR, LTEAFDD, LTEATDD
Preset	A
Range	MSR, LTEATDD, LTEAFDD, WLAN: A B C D E F G H  J K L Other modes without option N9060A-7FP: A B C D E F Other modes with option N9060A-7FP: A B C D E F G H  J K L
Initial S/W Revision	Prior to A.02.00
Modified at S/W Revision	A.02.00, A.03.00, A.10.00, A.11.00, A.14.00

## Start Freq

Specifies the start frequency for the currently selected offset. Also enables you to toggle that offset between On and Off.

Missing values are not permitted; that is, if you want to change values 2 and 6, you must send all values up to 6. Subsequent values will remain as they were. The query for this parameter always returns 12 values.

Key Path	Meas Setup, Offset/Limits
Mode	SA, WCDMA, C2K, WIMAX OFDMA, TD-SCDMA, 1xEVDO, DTMB (CTTB), DVB-T/H, ISDB-T, CMMB, LTE, LTE-TDD, Digital Cable TV, WLAN, MSR, LTEAFDD, LTEATDD
Remote Command	[ :SENSe ] :SEMask:OFFSet [ 1 ]   2 [ :OUTer ] :LIST:FREQuency:START <freq>, ... [ :SENSe ] :SEMask:OFFSet [ 1 ]   2 [ :OUTer ] :LIST:FREQuency:START? [ :SENSe ] :SEMask:OFFSet [ 1 ]   2 [ :OUTer ] :LIST:STATe ON OFF 1 0, ... [ :SENSe ] :SEMask:OFFSet [ 1 ]   2 [ :OUTer ] :LIST:STATe?

<b>Example</b>	<pre>SEM:OFFS2:LIST:FREQ:STAR 2.515 MHz , 2.715 MHz , 3.515 MHz , 4.00 MHz , 8.00 MHz , 12.50 MHz SEM:OFFS2:LIST:FREQ:STAR? SEM:OFFS:LIST:STAT ON , ON , ON , OFF , OFF , OFF SEM:OFFS:LIST:STAT?</pre>
<b>Notes</b>	<p>Comma separated list of values.          OFFSet1 is for BTS, 2 for MS. Default is BTS.          You must be in the mode that includes SEM measurement to use this command. Use          :INSTrument:SElect to set the mode.</p>
<b>Couplings</b>	<p>Coupled to Stop Freq. When the start freq goes above the stop freq, the stop freq is automatically          adjusted to the start freq plus 100 Hz.          If the current mode is DVB-T/H, this value will be modified automatically according to the limit type          and the output power of the transmitter which is less or more than 25 W.          If the current mode is ISDB-T, this value will be modified automatically according to the limit type.</p>
<b>Preset</b>	<p>For modes (except MSR, , LTEAFDD, , LTEATDD and WLAN) without option N9060A-7FP, , the          preset value is as follows.          SA: 2.515 MHz, , 2.715 MHz, , 3.515 MHz, , 4.00 MHz, , 8.00 MHz, , 12.50 MHz          WCDMA: 2.515 MHz, , 2.715 MHz, , 3.515 MHz, , 4.000 MHz, , 8.000 MHz, , 12.50          MHz 2.515MHz, , 4.000 MHz, , 7.500 MHz, , 8.500 MHz, , 12.5 MHz, , 15 MHz          C2K: 750.0 kHz, , 780.0 kHz, , 1.980 MHz, , 3.25 MHz, , 7.0 MHz, , 7.0 MHz 885 kHz, , 1.980          MHz, , 2.250 MHz, , 8.0 MHz, , 12.0 MHz, , 12.0 MHz          WIMAX OFDMA: 4.75 MHz, 5.45 MHz, 9.75 MHz, 14.75 MHz, 19.75 MHz, 24.75 MHz 4.75 MHz,          5.45 MHz, 9.75 MHz, 14.75 MHz, 19.75 MHz, 24.75 MHz          TD-SCDMA:          81 5kHz, 1015 kHz, 1815 kHz, 2.3 MHz, , , 2.3 MHz, , 2.3 MHz  815 kHz, 1.8 MHz, 2.9 MHz, , 2.9          MHz, 2.9 MHz, , 2.9 MHz          1xEVDO: 750.0 kHz, , 780.0 kHz, , 1.98 MHz, , 3.25 MHz, , 7 MHz, , 7 MHz 885.0 kHz, , 1.98 MHz,          , 1.98 MHz, , 1.98 MHz, , 1.98 MHz, , 1.98 MHz          DTMB (CTTB): 3.8 MHz, , 4.2 MHz, , 6 MHz, , 6 MHz, , 6 MHz, 6 MHz  6MHz, , 6MHz, , 6MHz, ,          6MHz, , 6MHz, , 6MHz          DVB-T/H: 3.81 MHz, , 4.2 MHz, , 6 MHz, , 6 MHz, , 6 MHz, , 6 MHz  6MHz, , 6MHz, , 6MHz, ,          , 6MHz, , 6MHz          ISDB-T: 2.79 MHz, , 2.86 MHz, , 3.0 MHz, , 4.36 MHz, , 6 MHz, , 6 MHz  6MHz, , 6MHz, , 6MHz, ,          6MHz, , 6MHz, , 6MHz          CMMB: 3.8 MHz, , 4.2 MHz, , 8.0 MHz, , 6 MHz, , 6 MHz, , 6 MHz  6MHz, , 6MHz, , 6MHz, ,          6MHz, , 6MHz          LTE, LTETDD: 50 kHz, , 5.05 MHz, , 10.5 MHz, , 15.00 MHz, , 30 MHz, , 40 MHz 15.00 kHz, 1.5          MHz, 5.5 MHz, 6.5 MHz, 10 MHz, 20MHz          Digital Cable TV: 3.8 MHz, , 4.2 MHz, , 6 MHz, , 6 MHz, , 6 MHz, , 6 MHz  6MHz, , 6MHz, , 6MHz, ,          6MHz, , 6MHz, , 6MHz          When option N9060A-7FP is installed in these modes, , the preset value of Offset G ~ L is the same          as the Offset F value.          -----</p>

---

WLAN:

if Radio Std is 802.11a/g(OFDM/DSSS-OFDM)/802.11n(20MHz): 9 MHz , 11 MHz , 20 MHz , 30 MHz , 50 MHz , 216 MHz , 216 MHz , 216 MHz , 216 MHz , 216 MHz , 216 MHz , 216 MHz

if Radio Std is 802.11b/g(DSSS/CCK/PBCC): 11 MHz , 22 MHz , 50 MHz , 70 MHz , 90 MHz , 100 MHz , , 100 MHz , 100 MHz , 100 MHz , 100 MHz , 100 MHz , 100 MHz

if Radio Std is 802.11n(20MHz): 9 MHz , 11 MHz , 20 MHz , 30 MHz , 50 MHz , 100 MHz , 100 MHz , 100 MHz , 100 MHz , 100 MHz , 100 MHz

if Radio Std is 802.11n(40MHz): 19 MHz , 21 MHz , 40 MHz , 60 MHz , 100 MHz , 200 MHz , 200 MHz , 200 MHz , 200 MHz , 200 MHz , 200 MHz

if Radio Std is 802.11ac(20MHz): 9 MHz , 11 MHz , 20 MHz , 30 MHz , 30 MHz , 30 MHz , 30 MHz , 30 MHz , 30 MHz , 30 MHz , 30 MHz , 30 MHz

if Radio Std is 802.11ac(40MHz): 19 MHz , 21 MHz , 40 MHz , 60 MHz , 60 MHz , 60 MHz , 60 MHz , 60 MHz , 60 MHz , 60 MHz , 60 MHz , 60 MHz

if Radio Std is 802.11ac(80MHz): 39 MHz , 41 MHz , 80 MHz , 120 MHz , 120 MHz , 120 MHz , 120 MHz , 120 MHz , 120 MHz , 120 MHz , 120 MHz , 120 MHz

if Radio Std is 802.11ac(160MHz): 79 MHz , 81 MHz , 160 MHz , 240 MHz , 240 MHz , 240 MHz , 240 MHz , 240 MHz , 240 MHz , 240 MHz , 240 MHz , 240 MHz

if Radio Std is 802.11ac(80 MHz + 80MHz): 0 MHz , 40 MHz , 79 MHz , 159 MHz , 161 MHz , 200 MHz , 240 MHz , 240 MHz , 240 MHz , 240 MHz , 240 MHz , 240 MHz , 240 MHz

MSR:15 kHz , 215kHz , 1.015MHz , 1.5MHz , 10.5MHz , 15.00MHz , 30MHz , 30MHz , 30MHz , 30MHz , 30MHz | 15kHz , 215kHz , 1.015MHz , 1.5MHz , 10.5MHz , 15.00MHz , 30MHz , 30MHz , 30MHz , 30MHz , 30MHz , 30MHz , 30MHz , 30MHz

LTEAFDD , LTEATDD: 50 kHz , 5.05 MHz , 10.5 MHz , 15.00 MHz , 30 MHz , 40 MHz , 40 MHz , 40 MHz , 40 MHz , 40 MHz , 40 MHz | 15.00 kHz , 1.5 MHz , 5.5 MHz , 6.5 MHz , 10 MHz , 20MHz , 20MHz , 20MHz , 20MHz , 20MHz , 20MHz , 20MHz

For modes (except MSR , LTEAFDD , LTEATDD and WLAN) without option N9060A-7FP , the preset value is as follows.

SA: ON, ON, ON, ON, ON, OFF

WCDMA: ON, , ON, , ON, , ON, , OFF|ON, , ON, , ON, , OFF, , OFF

C2K: ON, , ON, , ON, , OFF, , OFF, , OFF|ON, , ON, , OFF, , OFF, , OFF, , OFF

WIMAX OFDMA: ON, , ON, , ON, , OFF, , OFF, , OFF|ON, , ON, , ON, , OFF, , OFF, , OFF

TD-SCDMA: ON, , ON, , ON, , ON, , OFF, , OFF|ON, , ON, , ON, , OFF, , OFF, , OFF

1xEVDO: ON, , ON, , ON, , OFF, , OFF, , OFF|ON, , ON, , OFF, , OFF, , OFF, , OFF

DTMB (CTTB) , DVB-T/H , CMMB , Digital Cable TV: ON, , ON, , ON, , OFF, , OFF, , OFF

ISDB-T: ON, ON, ON, ON, OFF, OFF

LTE , LTEATDD: ON, , ON, , ON, , OFF, , OFF, , OFF|ON, ON, ON, ON, OFF, OFF

When option N9060A-7FP is installed in these modes , the preset value of Offset G ~ L is the same as the Offset F value.

-----

WLAN:

if Radio Std is 802.11b/g(DSSS/CCK/PBCC): ON, , ON, , OFF, , OFF, , OFF, , OFF, , OFF, , OFF, , OFF, , OFF, , OFF

if Radio Std is 802.11a/g(OFDM/DSSS-OFDM)/802.11n(20MHz/40MHz): ON, , ON, , ON, , ON, , OFF, , OFF, , OFF, , OFF, , OFF, , OFF, , OFF, , OFF

---

	<p>if Radio Std is 802.11ac (20 MHz/ 40 MHz/ 80 MHz/ 160 MHz): ON, , ON, , ON, , ON, , OFF, , OFF, , OFF, , OFF, , OFF, , OFF, , OFF, , OFF</p> <p>if Radio Std is 802.11ac (80 MHz + 80 MHz): ON, , ON, , ON, , ON, , ON, , ON, , OFF, , OFF, , OFF, , OFF, , OFF</p> <p>MSR:ON, , ON, , ON, , ON, , ON, , OFF, , OFF, , OFF, , OFF, , OFF, , OFF ON, , ON, , ON, , ON, , ON, , OFF, , OFF, , OFF, , OFF, , OFF, , OFF</p> <p>LTEAFDD, , LTEATDD: ON, , ON, , ON, , OFF, , OFF, , OFF, OFF, , OFF, , OFF, , OFF, OFF, OFF   ON, , ON, , ON, , ON, , OFF, , OFF, , OFF, , OFF, , OFF, , OFF, , OFF, , OFF</p>
State Saved	Saved in instrument state.
Min	0 Hz
Max	499.9999 MHz
Initial S/W Revision	Prior to A.02.00
Modified at S/W Revision	A.02.00, A.03.00, A.10.00, A.11.00, A.14.00

### Stop Freq

Specifies the stop frequency for the currently selected offset.

Missing values are not permitted; that is, if you want to change values 2 and 6, you must send all values up to 6. Subsequent values will remain as they were. The query for this parameter always returns 12 values.

Key Path	Meas Setup, Offset/Limits
Mode	SA, WCDMA, C2K, WIMAX OFDMA, TD-SCDMA, 1xEVDO, DTMB (CTTB), DVB-T/H, ISDB-T, CMMB, LTE, LTE-TDD, Digital Cable TV, WLAN, MSR, LTEAFDD, LTEATDD
Remote Command	<p>[ :SENSe] :SEMAsk:OFFSet [1]  2 [ :OUTer] :LIST:FREQuency:STOP &lt;freq&gt;, ...</p> <p>[ :SENSe] :SEMAsk:OFFSet [1]  2 [ :OUTer] :LIST:FREQuency:STOP?</p>
Example	<p>SEM:OFFS:LIST:FREQ:STOP 2.715 MHz, , 3.515 MHz, , 4.00 MHz, , 8.00 MHz, , 12.50 MHz, , 15.0 MHz</p> <p>SEM:OFFS:LIST:FREQ:STOP?</p>
Notes	<p>Comma separated list of values.</p> <p>OFFSet1 is for BTS, 2 for MS. Default is BTS.</p> <p>You must be in the mode that includes SEM measurement to use this command. Use :INSTrument:SElect to set the mode.</p>
Couplings	<p>Coupled to Start Freq. When the stop freq goes below the start freq, the start freq is automatically adjusted to the stop freq minus 100 Hz.</p> <p>If the current mode is DVB-T/H, this value will be modified automatically according to the limit type and the output power of the transmitter which is less or more than 25 W.</p> <p>If the current mode is ISDB-T, this value will be modified automatically according to the limit type.</p>
Preset	<p>For modes (except MSR, , LTEAFDD, , LTEATDD and WLAN) without option N9060A-7FP, , the preset value is as follows.</p> <p>SA: 2.715 MHz, , 3.515 MHz, , 4.00 MHz, , 8.00 MHz, , 12.50 MHz, , 15.0 MHz</p>

---

WCDMA: 2.715 MHz, 3.515 MHz, 4.000 MHz, 8.000 MHz, 12.50 MHz, 15.0 MHz | 3.485 MHz, 7.500 MHz, 8.500 MHz, 12.00 MHz, 15.00 MHz, 18.0 MHz

C2K: 780.0 kHz, 1.980 MHz, 4.0 MHz, 4.0 MHz, 12.0 MHz, 12.0 MHz | 1.980 MHz, 4.0 MHz, 4.0 MHz, 11.5 MHz, 14.5 MHz, 14.5 MHz

WiMAX OFDMA: 5.45 MHz, 9.75 MHz, 14.75 MHz, 19.75 MHz, 24.75 MHz, 29.75 MHz | 5.45 MHz, 9.75 MHz, 14.75 MHz, 19.75 MHz, 24.75 MHz, 29.75 MHz

TD-SCDMA:

1015 kHz, 1815 kHz, 2.3 MHz, 4 MHz, 4 MHz, 4 MHz | 1.8 MHz, 2385 kHz, 3.5 MHz, 3.5 MHz, 3.5 MHz, 3.5 MHz

1xEVDO: 780.0 kHz, 1.98 MHz, 4.0 MHz, 4.0 MHz, 12 MHz, 12 MHz | 1.98 MHz, 4.0 MHz, 4.0 MHz, 4.0 MHz, 4.0 MHz, 4.0 MHz

DTMB (CTTB): 4.2 MHz, 6 MHz, 12 MHz, 12 MHz, 12 MHz, 12 MHz | 12 MHz, 12 MHz, 12 MHz, 12 MHz, 12 MHz, 12 MHz

DVB-T/H: 4.2 MHz, 6 MHz, 12 MHz, 12 MHz, 12 MHz, 12 MHz | 12 MHz, 12 MHz, 12 MHz, 12 MHz, 12 MHz, 12 MHz

ISDB-T: 2.86 MHz, 3.0 MHz, 4.36 MHz, 15.0 MHz, 15.0 MHz, 15.0 MHz | 15 MHz, 15 MHz, 15 MHz, 15 MHz, 15 MHz, 15 MHz

CMMB: 4.2 MHz, 8.0 MHz, 12.0 MHz, 12.0 MHz, 12.0 MHz, 12.0 MHz | 12 MHz, 12 MHz, 12 MHz, 12 MHz, 12 MHz, 12 MHz

LTE, LTE TDD: 5.05 MHz, 10.05 MHz, 15 MHz, 30 MHz, 40 MHz, 50 MHz | 985.0 kHz, 4.50 MHz, 5.5001 MHz, 9.50 MHz, 20 MHz, 40 MHz

Digital Cable TV: 4.2 MHz, 6.0 MHz, 12.0 MHz, 12.0 MHz, 12.0 MHz, 12.0 MHz, 12 MHz, 12 MHz, 12 MHz, 12 MHz, 12 MHz, 12 MHz

When option N9060A-7FP is installed in these modes, the preset value of Offset G ~ L is the same as the Offset F value.

-----

WLAN:

if Radio Std is 802.11a/g(OFDM/DSSS-OFDM)/802.11n(20MHz): 11 MHz, 20 MHz, 30 MHz, 50 MHz, 100 MHz, 250 MHz, 250 MHz, 250 MHz, 250 MHz, 250 MHz, 250 MHz, 250 MHz

if Radio Std is 802.11b/g(DSSS/CCK/PBCC): 22 MHz, 50 MHz, 70 MHz, 90 MHz, 100 MHz, 120 MHz, 120 MHz, 120 MHz, 120 MHz, 120 MHz, 120 MHz, 120 MHz

if Radio Std is 802.11n(20MHz): 11 MHz, 20 MHz, 30 MHz, 50 MHz, 100 MHz, 200 MHz, 200 MHz, 200 MHz, 200 MHz, 200 MHz, 200 MHz, 200 MHz

if Radio Std is 802.11n(40MHz): 21 MHz, 40 MHz, 60 MHz, 100 MHz, 200 MHz, 300 MHz, 300 MHz, 300 MHz, 300 MHz, 300 MHz, 300 MHz, 300 MHz

if Radio Std is 802.11ac(20MHz): 11 MHz, 20 MHz, 30 MHz, 50 MHz, 50 MHz, 50 MHz, 50 MHz, 50 MHz, 50 MHz, 50 MHz, 50 MHz, 50 MHz

if Radio Std is 802.11ac(40MHz): 21 MHz, 40 MHz, 60 MHz, 100 MHz, 100 MHz, 100 MHz, 100 MHz, 100 MHz, 100 MHz, 100 MHz, 100 MHz, 100 MHz

if Radio Std is 802.11ac(80MHz): 41 MHz, 80 MHz, 120 MHz, 200 MHz, 200 MHz, 200 MHz, 200 MHz, 200 MHz, 200 MHz, 200 MHz, 200 MHz, 200 MHz

if Radio Std is 802.11ac(160MHz): 81 MHz, 160 MHz, 240 MHz, 400 MHz, 400 MHz, 400 MHz, 400 MHz, 400 MHz, 400 MHz, 400 MHz, 400 MHz, 400 MHz

if Radio Std is 802.11ac(80 MHz + 80MHz): 40 MHz, 79 MHz, 81 MHz, 161 MHz, 200 MHz, 200 MHz, 200 MHz, 200 MHz, 200 MHz, 200 MHz, 200 MHz, 200 MHz

---

	240 MHz , 260 MHz , 260 MHz , 260 MHz , 260 MHz , 260 MHz , 260 MHz MSR: 215kHz , 1.015MHz , 1.5MHz , 10.5MHz , 50MHz , 50MHz , 50MHz , 50MHz , 50MHz , 50MHz , 50MHz , 50MHz LTEAFDD , LTEATDD: 5.05 MHz , 10.05 MHz , 15 MHz , 30 MHz , 40 MHz , 50 MHz , 50 MHz , 50 MHz , 50 MHz , 50 MHz , 50 MHz , 50 MHz   985.0 kHz , 4.50 MHz , 5.5001 MHz , 9.50 MHz, 20 MHz , 40 MHz , , 40 MHz , 40 MHz , 40 MHz , 40 MHz , 40 MHz , 40 MHz
State Saved	Saved in instrument state.
Min	100 Hz
Max	500 MHz
Initial S/W Revision	Prior to A.02.00
Modified at S/W Revision	A.02.00, A.03.00, A.10.00, A.11.00, A.14.00

## Sweep Time

Specifies the sweep time for the currently selected offset and enables you to toggle the Sweep Time mode between Auto and Man.

Missing values are not permitted; that is, if you want to change values 2 and 6, you must send all values up to 6. Subsequent values will remain as they were. The query for this parameter always returns 12 values.

Key Path	Meas Setup, Offset/Limits
Mode	SA, WCDMA, C2K, WIMAX OFDMA, TD-SCDMA, 1xEVDO, DTMB (CTTB), DVB-T/H, ISDB-T, CMMB, LTE, LTE-TDD, Digital Cable TV, WLAN, MSR, LTEAFDD, LTEATDD
Remote Command	[ :SENSE ] :SEMAsk:OFFSet [ 1 ]   2 [ :OUTer ] :LIST:SWEep:TIME <time> , ... [ :SENSE ] :SEMAsk:OFFSet [ 1 ]   2 [ :OUTer ] :LIST:SWEep:TIME? [ :SENSE ] :SEMAsk:OFFSet [ 1 ]   2 [ :OUTer ] :LIST:SWEep:TIME:AUTO ON   OFF   1   0 , ... [ :SENSE ] :SEMAsk:OFFSet [ 1 ]   2 [ :OUTer ] :LIST:SWEep:TIME:AUTO?
Example	SEM:OFFS2:LIST:SWE:TIME 1.0 ms , 3.4 ms , 2.08 ms , 1.0 ms , 1.0 ms , 1.0 ms SEM:OFFS2:LIST:SWE:TIME? SEM:OFFS2:LIST:SWE:TIME:AUTO ON , ON , , ON , , OFF , , OFF SEM:OFFS2:LIST:SWE:TIME:AUTO?
Notes	Comma separated list of values. OFFSet1 is for BTS, 2 for MS. Default is BTS. You must be in the mode that includes SEM measurement to use this command. Use :INSTRument:SELEct to set the mode.
Couplings	When the sweep time is set manually, Sweep Time Mode is set to MANUAL. If the current mode is DVB-T/H, this value will be modified automatically according to the output power of the transmitter which is less or more than 25W. If the current mode is ISDB-T, this value will be modified automatically according to the limit type.
Preset	Automatically calculated

	Modes (except MSR, , LTEAFDD, , LTEATDD and WLAN) without option N9060A-7FP: ON, ON, ON, ON, ON, ON
	Modes (except MSR, , LTEAFDD, , LTEATDD and WLAN) with option N9060A-7FP: ON, ON, ON, ON, ON, ON, ON, ON, ON, ON, ON, ON, ON
	WLAN: ON, ON, ON, ON, ON, ON, ON, ON, ON, ON, , ON, ON, ON, ON
	MSR: ON,ON,ON,ON,ON,ON,ON,ON,ON,ON,ON,ON,ON
	LTEAFDD, , LTEATDD: ON, ON, ON, ON, ON, ON, ON, ON, ON, ON, ON, ON, ON, ON   ON, ON, ON, ON, ON, ON, ON, ON, ON, ON, ON, ON, ON
State Saved	Saved in instrument state.
Min	1 ms
Max	4000 s
<b>Backwards Compatibility SCPI</b>	[ :SENSe ] :SEMask:OFFSet [ 1 ]   2 :LIST:SWEep [ :TIME ]
Initial S/W Revision	Prior to A.02.00
Modified at S/W Revision	A.02.00, A.03.00, A.10.00, A.11.00, A.14.00

### Offset Side

Specifies which offset side to measure.

You can turn off (not use) specific offsets with [:SENSe]:SEMask:OFFSet[n][:OUTer]:LIST:STATe.

- **BOTH** – Both of the negative (lower) and positive (upper) sidebands
- **NEGative** – Negative (lower) sideband only
- **POSitive** – Positive (upper) sideband only

Missing values are not permitted; that is, if you want to change values 2 and 6, you must send all values up to 6. Subsequent values will remain as they were. The query for this parameter always returns 12 values.

The figure below shows the relation between the negative/positive offset side setups and the upper/lower results in the MSR and LTE-Advanced FDD/TDD.

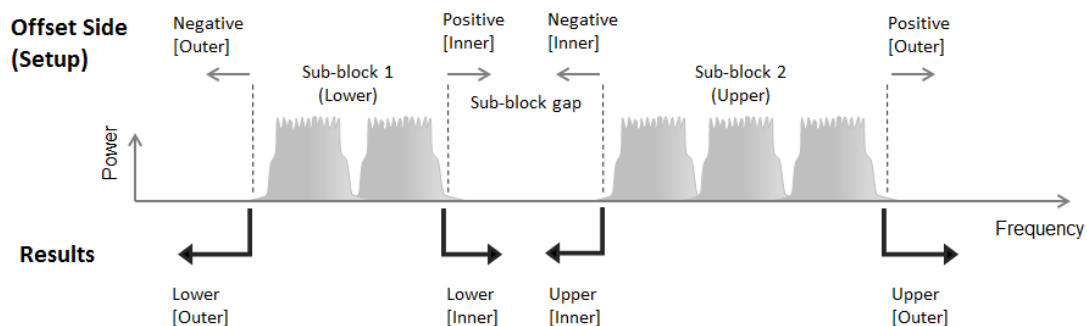

Key Path	Meas Setup, Offset/Limits
Mode	SA, WCDMA, C2K, WIMAX OFDMA, TD-SCDMA, 1xEVDO, DTMB (CTTB), DVB-T/H, ISDB-T, CMMB,

	LTE, LTETDD, Digital Cable TV, WLAN, MSR, LTEAFDD, LTEATDD
<b>Remote Command</b>	[ :SENSe ] :SEMAsk:OFFSet [1]   2 [ :OUTer ] :LIST:SIDE BOTH   NEGative   POSitive, ...  [ :SENSe ] :SEMAsk:OFFSet [1]   2 [ :OUTer ] :LIST:SIDE?
<b>Example</b>	SEM:OFFS:LIST:SIDE BOTH, , NEG, , NEG, , POS, , POS, , POS SEM:OFFS:LIST:SIDE?
<b>Notes</b>	Comma separated list of values. OFFSet1 is for BTS, 2 for MS. Default is BTS. You must be in the mode that includes SEM measurement to use this command. Use :INSTrument:SElect to set the mode.
<b>Preset</b>	Modes (except MSR, , LTEAFDD, , LTEATDD and WLAN) without option N9060A-7FP: BOTH, , BOTH, , BOTH, , BOTH, , BOTH Modes (except MSR, , LTEAFDD, , LTEATDD and WLAN) with option N9060A-7FP: BOTH, , BOTH, , BOTH, , BOTH, , BOTH, , BOTH, , BOTH, , BOTH, , BOTH, , BOTH, , BOTH MSR: BOTH, , BOTH, , BOTH, , BOTH, , BOTH, , BOTH, , BOTH, , BOTH, , BOTH, , BOTH, , BOTH LTEAFDD, LTEATDD: BOTH, , BOTH, , BOTH, , BOTH, , BOTH, , BOTH, , BOTH, , BOTH, , BOTH, , BOTH, , BOTH   BOTH, , BOTH, , BOTH, , BOTH, , BOTH, , BOTH, , BOTH, , BOTH, , BOTH, , BOTH, , BOTH WLAN: BOTH, , BOTH, , BOTH, , BOTH, , BOTH, , BOTH, , BOTH, , BOTH, , BOTH, , BOTH, , BOTH, , BOTH
<b>State Saved</b>	Saved in instrument state.
<b>Range</b>	Neg Both Pos
<b>Initial S/W Revision</b>	Prior to A.02.00
<b>Modified at S/W Revision</b>	A.02.00, A.03.00, A.10.00, A.11.00, A.14.00

## Res BW

Specifies which Resolution BW filter to use when measuring the currently selected offset.

Offset Res BW Mode allows the instrument to determine the optimum Resolution BW filter to use when measuring the currently selected offset.. When changing the Meas BW parameter, if the Res BW needs to be changed to adhere to the rule

$$(N \times \text{Res BW}) \leq (\text{Stop freq of the offset} - \text{Start freq of the offset}),$$

where N is the multiplier, this setting will automatically be changed to manual.

Missing values are not permitted; that is, if you want to change values 2 and 6, you must send all values up to 6. Subsequent values will remain as they were. The query for this parameter always returns 12 values.

<b>Key Path</b>	Meas Setup, Offset/Limits
<b>Mode</b>	SA, WCDMA, C2K, WIMAX OFDMA, TD-SCDMA, 1xEVDO mode, DTMB (CTTB), DVB-T/H, ISDB-T, CMMB, LTE, LTETDD, Digital Cable TV, WLAN, MSR, LTEAFDD, LTEATDD



<b>Remote Command</b>	<pre>[ :SENSe ] :SEMask:OFFSet [1]   2 [ :OUTer ] :LIST:BANDwidth [ :RESolution ] &lt;bandwidth&gt;, ...  [ :SENSe ] :SEMask:OFFSet [1]   2 [ :OUTer ] :LIST:BANDwidth [ :RESolution ] ?  [ :SENSe ] :SEMask:OFFSet [1]   2 [ :OUTer ] :LIST:BANDwidth [ :RESolution ] :AUTO OFF   ON   1   0, ...  [ :SENSe ] :SEMask:OFFSet [1]   2 [ :OUTer ] :LIST:BANDwidth [ :RESolution ] :AUTO?</pre>
<b>Example</b>	<pre>SEM:OFFS2:LIST:BAND 30.0 kHz , 30.0 kHz , 30.0 kHz , 1.00 MHz, 1.00 MHz , 1.00 MHz SEM:OFFS2:LIST:BAND? SEM:OFFS:LIST:BAND:AUTO 1,1,1,1,1,1 SEM:OFFS:LIST:BAND:AUTO?</pre>
<b>Notes</b>	<p>Comma separated list of values.          OFFSet1 is for BTS, 2 for MS. Default is BTS.          You must be in the mode that includes SEM measurement to use this command. Use          :INSTrument:SElect to set the mode.</p>
<b>Couplings</b>	<p>Coupled to Start and Stop offset and Meas BW multiplier. This parameter must adhere to the rule (N x Res BW) &lt;= (Stop freq of the offset - Start freq of the offset), where N is the multiplier. If the multiplier is changed, the Res BW will be changed to ensure this. When set manually, Res BW Coupling is set to manual.          The resolution bandwidth is coupled to the offset width determined by the start frequency and stop frequency.</p>
<b>Preset</b>	<p>For modes (except MSR, LTEAFDD, LTEATDD and WLAN) without option N9060A-7FP, the preset value is as follows.</p> <pre>SA: 30.0 kHz , 30.0 kHz , 30.0 kHz , 1.00 MHz, 1.00 MHz , 1.00 MHz WCDMA: 30.00 kHz , 30.00 kHz , 30.00 kHz , 100.00 kHz , 1.000 MHz , 1.00 MHz 30.00 kHz , 1.000 MHz , 1.000 MHz , 1.000 MHz , 1.00 MHz C2K: 3.00 kHz , 30.00 kHz , 30.00 kHz , 6.2 kHz , 1.000 MHz , 1.00 MHz 30.00 kHz , 30.00 kHz , 6.2 kHz , 1.000 MHz , 1.000 MHz , 1.00 MHz WIMAX OFDMA: 100 KHz , 100 KHz , 100 KHz , 100 KHz , 100 KHz , 100 KHz  100 KHz , 100 KHz , 100 KHz , 100 KHz , 100 KHz TD-SCDMA: 30 kHz , 30 kHz , 30 kHz , 50 kHz , 1 MHz , 1 MHz  30 kHz , 30 kHz , 50 kHz , 1 MHz , 1 MHz , 1 MHz 1xEVDO: 30.00 kHz , 30.00 kHz , 30.00 kHz , 6.2 kHz , 1.000 MHz , 1.000 MHz 30.00 kHz , 30.00 kHz , 30.00 kHz , 30.00 kHz , 30.00 kHz DTMB (CTTB), , DVB-T/H, , CMMB, , Digital Cable TV: 3.9 kHz , 3.9 kHz , 3.9 kHz , 3.9 kHz , 3.9 kHz , 3.9 kHz  30.00 kHz , 1.000 MHz , 1.000 MHz , 1.000 MHz , 1.000 MHz , 1.00 MHz ISDB-T: 10.0 kHz , 10.0 kHz , 10.0 kHz , 10.0 kHz , 10. kHz , 10.0 kHz  30.00 kHz , 1.000 MHz , 1.000 MHz , 1.000 MHz , 1.00 MHz LTE, , LTETDD: 51 kHz , 100 kHz , 1.0 MHz , 1.0 MHz, 1.0 MHz , 1.0 MHz 15.0 kHz , 510 kHz , 1.0 MHz, 1.0 MHz, 1.0 MHz, 1.0 MHz</pre> <p>When option N9060A-7FP is installed in these modes, the preset value of Offset G ~ L is the same as the Offset F value.</p> <p>-----</p> <pre>WLAN: 100 KHz , 100 KHz , 100 KHz , 100 KHz , 100 KHz , 100 KHz , 100 KHz , 100 KHz , 100 KHz , 100 KHz , 100 KHz , 100 KHz</pre>

---

	MSR: 30kHz, 30kHz, 30kHz, 1.0MHz, 1.0MHz, 1.0MHz, 1.0MHz, 1.0MHz, 1.0MHz, 1.0MHz, 1.0MHz, 1.0MHz   30kHz, 30kHz, 30kHz, 1.0MHz, 1.0MHz, 1.0MHz, 1.0MHz, 1.0MHz, 1.0MHz, 1.0MHz, 1.0MHz, 1.0MHz
	LTEAFDD, LTEATDD: 51 kHz, 100 kHz, 1.0 MHz, 1.0 MHz, 1.0 MHz, 1.0 MHz, 1.0 MHz, 1.0 MHz, 1.0 MHz, 1.0 MHz   15.0 kHz, 510 kHz, 1.0 MHz, 1.0 MHz, 1.0 MHz, 1.0 MHz, 1.0 MHz, 1.0 MHz, 1.0 MHz, 1.0 MHz, 1.0 MHz, 1.0 MHz
	Modes (except MSR, LTEAFDD, LTEATDD and WLAN) without option N9060A-7FP: OFF, OFF, OFF, OFF, OFF, OFF, OFF, OFF, OFF, OFF, OFF, OFF
	Modes (except MSR, LTEAFDD, LTEATDD and WLAN) with option N9060A-7FP: OFF, OFF, OFF, OFF, OFF, OFF, OFF, OFF, OFF, OFF, OFF, OFF, OFF, OFF, OFF, OFF, OFF, OFF, OFF, OFF, OFF, OFF
	MSR: OFF, OFF, OFF, OFF, OFF, OFF, OFF, OFF, OFF, OFF, OFF, OFF, OFF, OFF, OFF, OFF, OFF, OFF, OFF, OFF, OFF, OFF, OFF, OFF
	LTEAFDD, LTEATDD: OFF, OFF, OFF, OFF, OFF, OFF, OFF, OFF, OFF, OFF, OFF, OFF, OFF, OFF, OFF, OFF, OFF, OFF, OFF, OFF, OFF, OFF, OFF, OFF
	WLAN: OFF, OFF, OFF, OFF, OFF, OFF, OFF, OFF, OFF, OFF, OFF, OFF, OFF, OFF, OFF, OFF, OFF, OFF, OFF, OFF, OFF, OFF, OFF, OFF
State Saved	Saved in instrument state.
Min	1 Hz
Max	8 MHz
<b>Backwards Compatibility SCPI</b>	[ :SENSE ] :SEMAsk :OFFSet [ 1 ]   2 :LIST :BWIDth [ :RESolution ]
Initial S/W Revision	Prior to A.02.00
Modified at S/W Revision	A.02.00, A.03.00, A.10.00, A.11.00, A.14.00

---

## Meas BW

Allows you to specify a multiplier of Res BW for the measurement integration bandwidth.

Meas BW is multiplier integer number. It shows a ratio between Integration BW and Resolution BW of the measurement result.

$$\text{Integ BW} = \text{Meas BW} * \text{Resolution BW}$$

Integration BW is desired resolution bandwidth and Resolution BW is actual bandwidth for sweep. Measurement sweeps with Resolution BW and Meas BW compensates sweep resolution bandwidth to Integration BW.

If you set this parameter greater than 1, you can set Resolution BW narrower to avoid carrier power leakage effect to the offset power integration.

Missing values are not permitted; that is, if you want to change values 2 and 6, you must send all values up to 6. Subsequent values will remain as they were. The query for this parameter always returns 12 values.

---

<b>Key Path</b>	<b>Meas Setup, Offset/Limits</b>
<b>Mode</b>	SA, WCDMA, C2K, WIMAX OFDMA, TD-SCDMA, 1xEVDO, DTMB (CTTB), DVB-T/HISDB-T, CMMB,

---

	LTE, LTE-TDD, Digital Cable TV, WLAN
<b>Remote Command</b>	[ :SENSe ] :SEMAsk:OFFSet [ 1 ]   2 [ :OUTer ] :LIST:Bandwidth:IMULti <integer>, ... [ :SENSe ] :SEMAsk:OFFSet [ 1 ]   2 [ :OUTer ] :LIST:Bandwidth:IMULti?
<b>Example</b>	SEM:OFFS2:LIST:BAND:IMUL 1,1,1,1,1 SEM:OFFS2:LIST:BAND:IMUL?
<b>Notes</b>	Comma separated list of values. OFFSet1 is for BTS, 2 for MS. Default is BTS. You must be in the mode that includes SEM measurement to use this command. Use :INSTrument:SElect to set the mode.
<b>Couplings</b>	This parameter must adhere to the rule (N x Res BW) <= (Stop freq of the offset - Start freq of the offset), where N is the multiplier. If the Res Bw is changed, the multiplier will be changed to ensure this.
<b>Preset</b>	For modes (except MSR, , LTEAFDD, , LTEATDD and WLAN) without option N9060A-7FP, , the preset value is as follows. SA: 1, 1, 1, 1, 1, 1 WCDMA: 1, , 1, , 1, , 10, , 1, , 1 1, , 1, , 1, , 1, , 1 C2K: 10, 1, 1, 1, 1, 1 1, 1, 1, 1, 1, 1 WIMAX OFDMA, , 1xEVDO: 1, , 1, , 1, , 1, , 1 1, , 1, , 1, , 1, , 1 TD-SCDMA:1, , 1, , 1, , 20, , 1, , 1 1, , 1, , 20, , 1, , 1, , 1 DTMB (CTTB), , DVB-T/H, , ISDB-T, , CMMB, , Digital Cable TV: 1, , 1, , 1, , 1, , 1  1, , 1, , 1, , 1, , 1 LTE, , LTE-TDD: 2, , 1, , 1, , 1, , 1 2, , 2, , 1, , 1, , 1, 1 When option N9060A-7FP is installed in these modes, , the preset value of Offset G ~ L is the same as the Offset F value. ----- WLAN: 1, 1, 1, 1, 1, 1, 1, 1, 1, 1, 1 MSR: 1, , 1, , 1, , 1, , 1, , 1, , 1, , 1, , 1, , 1 1, , 1, , 1, , 1, , 1, , 1, , 1, , 1, , 1 LTEAFDD, , LTEATDD: 2, , 1, , 1, , 1, , 1, , 1, , 1, , 1, , 1, , 1 2, , 2, , 1, , 1, , 1, , 1, , 1, , 1, , 1, , 1
<b>State Saved</b>	Saved in instrument state.
<b>Min</b>	1
<b>Max</b>	1000
<b>Backwards Compatibility SCPI</b>	[ :SENSe ] :SEMAsk:OFFSet [ 1 ]   2 :LIST:BWIDth:IMULti
<b>Initial S/W Revision</b>	Prior to A.02.00
<b>Modified at S/W Revision</b>	A.02.00, A.03.00, A.10.00, A.11.00, A.14.00

## Video BW

Changes the analyzer post-detection filter.

Missing values are not permitted; that is, if you want to change values 2 and 6, you must send all values up to 6. Subsequent values will remain as they were. The query for this parameter always returns 12 values.

<b>Key Path</b>	Meas Setup, Offset/Limits
<b>Mode</b>	SA, WCDMA, C2K, WIMAXOFDMA, TD-SCDMA, 1xEVDO, DTMB (CTTB), DVB-T/H, ISDB-T, CMMB, LTE, LTE-TDD, Digital Cable TV, WLAN, MSR, LTEAFDD, LTEATDD
<b>Remote Command</b>	[:SENSe]:SEMAsk:OFFSet [1]   2[:OUTer]:LIST:BAWdth:VIDeo <freq>, ... [:SENSe]:SEMAsk:OFFSet [1]   2[:OUTer]:LIST:BAWdth:VIDeo? [:SENSe]:SEMAsk:OFFSet [1]   2[:OUTer]:LIST:BAWdth:VIDeo:AUTO OFF   ON   0   1, ... [:SENSe]:SEMAsk:OFFSet [1]   2[:OUTer]:LIST:BAWdth:VIDeo:AUTO?
<b>Example</b>	SEM:OFFS2:LIST:BAW:VID 3.00 kHz, , 3.00 kHz, , 3.00 kHz, , 100.0 kHz, 100.0 kHz, , 100.0 kHz SEM:OFFS2:LIST:BAW:VID? SEM:OFFS2:LIST:BAW:VID:AUTO ON, , ON, , ON, , ON, , ON SEM:OFFS2:LIST:BAW:VID:AUTO?
<b>Notes</b>	Comma separated list of values. OFFSet1 is for BTS, 2 for MS. Default is BTS. You must be in the mode that includes SEM measurement to use this command. Use :INSTRument:SElect to set the mode.
<b>Preset</b>	ISDB-T: 1.0kHz, , 1.0kHz, , 1.0kHz, , 1.0kHz, , 1.0kHz, , 1.0kHz Other than ISDB-T: Automatically Calculated Modes (except MSR, , LTEAFDD, , LTEATDD, , WLAN, , ISDB-T) without option N9060A-7FP: ON, , ON, , ON, , ON, , ON ON, , ON, , ON, , ON, , ON Modes (except MSR, , LTEAFDD, , LTEATDD, , WLAN, , ISDB-T) with option N9060A-7FP:ON, , ON, , ON, , ON, , ON, , ON, , ON, , ON, , ON, , ON, , ON ON, , ON, , ON, , ON, , ON, , ON, , ON, , ON, , ON ----- MSR, , LTEAFDD, , LTEATDD: ON, , ON, , ON, , ON, , ON, , ON, , ON, , ON, , ON, , ON ON, , ON, , ON, , ON, , ON, , ON, , ON, , ON, , ON, , ON WLAN: ON, , ON, , ON, , ON, , ON, , ON, , ON, , ON, , ON, , ON, , ON  ON, , ON, , ON, , ON, , ON, , ON, , ON, , ON, , ON ISDB-T: OFF, , OFF, , OFF, , OFF, , OFF, , OFF OFF, , OFF, , OFF, , OFF, , OFF, , OFF
<b>State Saved</b>	Saved in instrument state.
<b>Min</b>	1 Hz
<b>Max</b>	50 MHz
<b>Backwards Compatibility SCPI</b>	[:SENSe]:SEMAsk:OFFSet [1]   2:LIST:BAWIDth:VIDeo
<b>Initial S/W Revision</b>	Prior to A.02.00
<b>Modified at S/W Revision</b>	A.02.00, A.03.00, A.10.00, A.11.00, A.14.00

### VBW/RBW

Selects the ratio between the video and resolution bandwidths.

Missing values are not permitted; that is, if you want to change values 2 and 6, you must send all values up to 6. Subsequent values will remain as they were. The query for this parameter always returns 12 values.

<b>Key Path</b>	<b>Meas Setup, Offset/Limits</b>
<b>Mode</b>	SA, WCDMA, C2K, WIMAX OFDMA, TD-SCDMA, 1xEVDO, DTMB (CTTB), DVB-T/H, ISDB-T, CMMB, LTE, LTE-TDD, Digital Cable TV, WLAN, MSR, LTEAFDD, LTEATDD
<b>Remote Command</b>	[ :SENSe]:SEMask:OFFSet [1]   2 [:OUTer]:LIST:BANDwidth:VIDeo:RATio <real>, ... [ :SENSe]:SEMask:OFFSet [1]   2 [:OUTer]:LIST:BANDwidth:VIDeo:RATio? [ :SENSe]:SEMask:OFFSet [1]   2 [:OUTer]:LIST:BANDwidth:VIDeo:RATio:AUTO OFF   ON   0   1, ... [ :SENSe]:SEMask:OFFSet [1]   2 [:OUTer]:LIST:BANDwidth:VIDeo:RATio:AUTO?
<b>Example</b>	SEM:OFFS2:LIST:BAND:VID:RAT 0.1, , 0.1, , 0.1, , 0.1, , 0.1, , 0.1 SEM:OFFS2:LIST:BAND:VID:RAT? SEM:OFFS2:LIST:BAND:VID:RAT:AUTO ON, , ON, , ON, , ON, , ON SEM:OFFS2:LIST:BAND:VID:RAT:AUTO?
<b>Notes</b>	Comma separated list of values. OFFSet1 is for BTS, 2 for MS. Default is BTS. You must be in the mode that includes SEM measurement to use this command. Use :INSTRument:SElect to set the mode.
<b>Preset</b>	For modes (except MSR, , LTEAFDD, , LTEATDD and WLAN) without option N9060A-7FP, , the preset value is as follows. SA, , WCDMA, , C2K, , LTE, , LTE-TDD: 0.01, , 0.01, , 0.01, , 0.01, , 0.01, , 0.01 0.01, , 0.01, , 0.01, , 0.01, , 0.01, , 0.01 WIMAX OFDMA: 0.3, , 0.3, , 0.3, , 0.3, , 0.3, , 0.3 TD-SCDMA: 10, , 10, , 10, , 10, , 1, , 1  10, , 10, , 10, , 1, , 1, , 1 1xEVDO: 10, , 10, , 10, , 10, , 10, , 10 10, , 10, , 10, , 10, , 10 DTMB (CTTB), , DVB-T/H, , CMMB, , Digital Cable TV: 10, , 10, , 10, , 10, , 10, , 10  10, , 10, , 10, , 10, , 10, , 10 ISDB-T: 0.1, , 0.1, , 0.1, , 0.1, , 0.1, , 0.1  10, , 10, , 10, , 10, , 10, , 10 When option N9060A-7FP is installed in these modes, , the preset value of Offset G ~ L is the same as the Offset F value. ----- WLAN: 0.3, , 0.3, , 0.3, , 0.3, , 0.3, , 0.3, , 0.3, , 0.3, , 0.3, , 0.3 MSR, , LTEAFDD, , LTEATDD: 0.01, , 0.01, , 0.01, , 0.01, , 0.01, , 0.01, , 0.01, , 0.01, , 0.01, , 0.01, , 0.01, , 0.01 Modes (except MSR, , LTEAFDD, , LTEATDD and WLAN) without option N9060A-7FP: OFF, , OFF, , OFF, , OFF, , OFF OFF, , OFF, , OFF, , OFF, , OFF, , OFF Modes (except MSR, , LTEAFDD, , LTEATDD and WLAN) with option N9060A-7FP: OFF, , OFF, , OFF, , OFF, , OFF, , OFF, , OFF, , OFF, , OFF, , OFF, , OFF, , OFF, , OFF, , OFF, , OFF, , OFF, , OFF, , OFF, , OFF, , OFF, , OFF, , OFF, , OFF, , OFF, , OFF, , OFF, , OFF MSR, , LTEAFDD, , LTEATDD: OFF, , OFF, , OFF, , OFF, , OFF, , OFF, , OFF, , OFF, , OFF, , OFF, , OFF, , OFF WLAN: OFF, , OFF, , OFF, , OFF, , OFF, , OFF, , OFF, , OFF, , OFF, , OFF, , OFF, , OFF, , OFF, , OFF, , OFF, , OFF, , OFF, , OFF, , OFF, , OFF, , OFF, , OFF, , OFF

	, OFF
State Saved	Saved in instrument state.
Min	0.00001
Max	3000000
Initial S/W Revision	Prior to A.02.00
Modified at S/W Revision	A.02.00, A.03.00, A.10.00, A.11.00, A.14.00

## Limits

Accesses a menu that enables you to set the power limits for start and stop frequencies of the selected offsets.

Key Path	Meas Setup
Initial S/W Revision	Prior to A.02.00

## Select Offset

Selects the offset (upper and lower) and displays the memory selection menu that enables you to store a set of parameter values for the offset, such as Start Freq, Stop Freq, Sweep Time, Res BW, Meas BW, Abs Start, and Abs Stop. Only one selection at a time is shown on this menu key label.

Key Path	Meas Setup, Offset/Limits
Mode	SA, WCDMA, C2K, WIMAX OFDMA, TD-SCDMA, 1xEVDO, DTMB (CTTB), DVB-T/H, ISDB-T, CMMB, LTE, LTE-TDD, Digital Cable TV, WLAN, MSR, LTEAFDD, LTEATDD
Preset	A
Range	MSR, LTEATDD, LTEAFDD, WLAN: A B C D E F G H I J K L Other modes without option N9060A-7FP: A B C D E F Other modes with option N9060A-7FP: A B C D E F G H I J K L
Initial S/W Revision	Prior to A.02.00
Modified at S/W Revision	A.02.00, A.03.00, A.10.00, A.11.00, A.14.00

## Abs Start

Sets the absolute power level limit at the start frequency for the selected offset. The absolute power level limit ranges from -200 to +50 dBm.

The fail condition for each offset channel is set remotely by [:SENSe]:SEMAsk:OFFSet[n]  
[:OUTer]:LIST:TEST.

You can turn off (not use) specific offset channels remotely with [:SENSe]:SEMAsk:OFFSet[n]  
[:OUTer]:LIST:STATe.

The SCPI query returns values currently set to the absolute power test limits.

Missing values are not permitted; that is, if you want to change values 2 and 6, you must send all values up to 6. Subsequent values will remain as they were. The query for this parameter always returns 12 values.

Key Path	Meas Setup, Offset/Limit, Limits
Mode	SA, WCDMA, C2K, WIMAX OFDMA, TD-SCDMA, 1xEVDO, DTMB (CTTB), DVB-T/H, ISDB-T, CMMB, LTE, LTEFDD, Digital Cable TV, WLAN, MSR, LTEAFDD, LTEATDD
Remote Command	[ :SENSe ] :SEMAsk:OFFSet [ 1 ]   2 [ :OUTer ] :LIST:STARt:ABSolute <real>, ... [ :SENSe ] :SEMAsk:OFFSet [ 1 ]   2 [ :OUTer ] :LIST:STARt:ABSolute?
Example	SEM:OFFS2:LIST:STAR:ABS -12.50 dBm, , -12.50 dBm, , -24.50 dBm, , -11.50 dBm, , -11.50 dBm, , -11.50 dBm SEM:OFFS2:LIST:STAR:ABS?
Notes	Comma separated list of values. OFFSet1 is for BTS, 2 for MS. Default is BTS. You must be in the mode that includes SEM measurement to use this command. Use :INSTrument:SElect to set the mode.
Couplings	If the current mode is DVB-T/H, this value will be modified automatically according to the limit type and the output power of the transmitter which is less or more than 25W. If the current mode is ISDB-T, this value will be modified automatically according to the limit type.
Preset	For modes (except MSR, LTEAFDD, , LTEATDD and WLAN) without option N9060A-7FP, , the preset value is as follows. SA, , WIMAX OFDMA: -14.00 dBm, , -14.00 dBm, , -26.00 dBm, , -13.00 dBm, , -13.00 dBm, , -13.00 dBm WCDMA: -12.50 dBm, , -12.50 dBm, , -24.50 dBm, , -11.50 dBm, , -11.50 dBm, , -11.50 dBm -69.6 dBm, , -54.3 dBm, , -54.3 dBm, , -54.3 dBm, , -54.3 dBm, , -54.3 dBm C2K: -27.00 dBm, , -27.00 dBm, , -27.00 dBm, , -46.00 dBm, , -13.00 dBm, , -13.00 dBm -70.13 dBm, , -70.13 dBm, , -35.00 dBm, , -13.00 dBm, , -13.00 dBm, , -13.00 dBm TD-SCDMA: -28 dBm, , -28 dBm, , -36 dBm, , -21 dBm, , -21 dBm, , -21 dBm -71.3 dBm, , -71.3 dBm, , -56.07 dBm, , -56.07 dBm, , -56.07 dBm, , -56.07 dBm 1xEVDO: -27.0dBm, , -27.00 dBm, , -27.00 dBm, , -46.00 dBm, , -13.00 dBm, , -13.00 dBm -70.13 dBm, , -70.13 dBm, , -70.13 dBm, , -70.13 dBm, , -70.13 dBm, , -70.13 dBm DTMB (CTTB): -14.0 dBm, , -14.0 dBm, , -26.0 dBm, , -13.0 dBm, , -13.0 dBm, , -13.0 dBm  -13.0 dBm, , -13.0 dBm, , -13.0 dBm, , -13.0 dBm, , -13.0 dBm, , -13.0 dBm DVB-T/H: 11.2 dBm, , -29 dBm, , -41 dBm, , -66 dBm, , -82 dBm, , -82 dBm  -82 dBm, , -82 dBm, , -82 dBm, , -82 dBm, , -82 dBm ISDB-T, , CMMB, , Digital Cable TV: 50.0 dBm, , 50.0 dBm, , 50.0 dBm, , 50.0 dBm, , 50.0 dBm, , 50.0 dBm  50.0 dBm, , 50.0 dBm, , 50.0 dBm, , 50.0 dBm, , 50.0 dBm, , 50.0 dBm LTE, , LTEFDD: -5.5 dBm, , -12.5 dBm, , -15.0 dBm, , -15.0 dBm, , -15.0 dBm, , -15.0 dBm -13.5 dBm, , -8.5 dBm, , -11.5 dBm, , -23.5 dBm, , -23.5 dBm, , -23.5 dBm When option N9060A-7FP is installed in these modes, , the preset value of Offset G ~ L is the same as the Offset F value. ----- WLAN: if Radio Std is 802.11 a/g(OFDM/DSSS-OFDM): 16.00 dBm, , -4.00 dBm, , -12.00 dBm, , -

24.00 dBm, , -24.00 dBm, , -24.00 dBm, , -24.00 dBm, , -24.00 dBm, , -24.00 dBm, , -24.00 dBm, , -24.00 dBm, , -24.00 dBm

if Radio Std is 802.11b/g(DSSS/CCK/PBCC): -10 dBm, , -30 dBm, , -30 dBm, , -30 dBm, , -30 dBm, , -30 dBm, , -30 dBm, , -30 dBm, , -30 dBm, , -30 dBm, , -30 dBm, , -30 dBm, , -30 dBm

if Radio Std is 802.11n(20MHz) or 802.11ac(20MHz): 16.00 dBm, , -4.00 dBm, , -12.00 dBm, , -63.00 dBm, , -63.00 dBm, , -63.00 dBm, , -63.00 dBm, , -63.00 dBm, , -63.00 dBm, , -63.00 dBm, , -63.00 dBm

if Radio Std is 802.11n(40MHz) or 802.11ac(40MHz): 16.00 dBm, , -4.00 dBm, , -12.00 dBm, , -66.00 dBm, , -66.00 dBm, , -66.00 dBm, , -66.00 dBm, , -66.00 dBm, , -66.00 dBm, , -66.00 dBm, , -66.00 dBm, , -66.00 dBm

if Radio Std is 802.11ac(80MHz/160MHz): 16.00 dBm, , -4.00 dBm, , -12.00 dBm, , -69.00 dBm, , -69.00 dBm, , -69.00 dBm, , -69.00 dBm, , -69.00 dBm, , -69.00 dBm, , -69.00 dBm, , -69.00 dBm, , -69.00 dBm

if Radio Std is 802.11ac (80 MHz + 80 MHz): -69.00 dBm, , -69.00 dBm, , -69.00 dBm, , -69.00 dBm, , -69.00 dBm, , -69.00 dBm, , -69.00 dBm, , -69.00 dBm, , -69.00 dBm, , -69.00 dBm, , -69.00 dBm

MSR: -12.5 dBm, , -12.5 dBm, , -24.5 dBm, , -11.5 dBm, , -15.0 dBm, , -15.0 dBm, , -15.0 dBm, , -15.0 dBm, , -15.0 dBm, , -15.0 dBm, , -15.0 dBm, , -15.0 dBm, , -15.0 dBm, , -15.0 dBm, , -15.0 dBm, , -15.0 dBm, , -15.0 dBm, , -15.0 dBm, , -15.0 dBm

LTEAFDD, , LTEATDD: -5.5 dBm, , -12.5 dBm, , -15.0 dBm, , -15.0 dBm, , -15.0 dBm, , -15.0 dBm, , -15.0 dBm, , -15.0 dBm, , -15.0 dBm, , -15.0 dBm, , -15.0 dBm, , -15.0 dBm, , -15.0 dBm, , -15.0 dBm, , -13.5 dBm, , -8.5 dBm, , -11.5 dBm, , -23.5 dBm, , -23.5 dBm, , -23.5 dBm, , -23.5 dBm, , -23.5 dBm, , -23.5 dBm, , -23.5 dBm, , -23.5 dBm, , -23.5 dBm, , -23.5 dBm

State Saved	Saved in instrument state.
Min	-200 dBm
Max	50 dBm
Initial S/W Revision	Prior to A.02.00
Modified at S/W Revision	A.02.00, A.03.00, A.10.00, A.11.00, A.14.00

### Abs Stop

Sets the absolute power level limit at the stop frequency for the selected offset. The absolute power level limit ranges from -200 to +50 dBm. You can also toggle this function between couple and manual. If set to Couple, the Abs Stop power level limit is coupled to Abs Start to result in a flat limit line. If set to Man, Abs Start and Abs Stop take different values to result in a sloped limit line.

The SCPI query returns values currently set to the offset stop absolute power limits.

Missing values are not permitted; that is, if you want to change values 2 and 6, you must send all values up to 6. Subsequent values will remain as they were. The query for this parameter always returns 12 values.

Key Path	Meas Setup, Offset/Limits, Limits
Mode	SA, WCDMA, C2K, WIMAX OFDMA, TD-SCDMA, 1xEVDO, DTMB (CTTB), DVB-T/H, ISDB-T, CMMB, LTE, LTETDD, Digital Cable TV, WLAN, MSR, LTEAFDD, LTEATDD



<b>Remote Command</b>	<pre>[ :SENSe ] :SEMAsk:OFFSet [1]   2 [ :OUTer ] :LIST:STOP:ABSolute &lt;real&gt;, ... [ :SENSe ] :SEMAsk:OFFSet [1]   2 [ :OUTer ] :LIST:STOP:ABSolute? [ :SENSe ] :SEMAsk:OFFSet [1]   2 [ :OUTer ] :LIST:STOP:ABSolute:COUPle ON   OFF   1   0, ... [ :SENSe ] :SEMAsk:OFFSet [1]   2 [ :OUTer ] :LIST:STOP:ABSolute:COUPle?</pre>
<b>Example</b>	<pre>SEM:OFFS:LIST:STOP:ABS -12.50 dBm, , -24.50 dBm, , -24.50 dBm, , -11.50 dBm, , -11.50 dBm, , -11.50 dBm SEM:OFFS1:LIST:STOP:ABS? SEM:OFFS:LIST:STOP:ABS:COUP ON, , OFF, , ON, , ON, , ON, , ON SEM:OFFS:LIST:STOP:ABS:COUP?</pre>
<b>Notes</b>	<p>Comma separated list of values.          OFFSet1 is for BTS, 2 for MS. Default is BTS.          You must be in the mode that includes SEM measurement to use this command. Use          :INSTrument:SElect to set the mode.</p>
<b>Couplings</b>	<p>Coupled to Abs Start if "Auto" is selected, that is, the Stop value is equal to the Start value.          If the current mode is DVB-T/H, this value will be modified automatically according to the limit type          and the output power of the transmitter which is less or more than 25W.          If the current mode is ISDB-T, this value will be modified automatically according to the limit type.</p>
<b>Preset</b>	<p>For modes (except MSR, LTEAFDD, , LTEATDD and WLAN) without option N9060A-7FP, , the          preset value is as follows.</p> <pre>SA, , WIMAX OFDMA: -14.00 dBm, , -26.00 dBm, , -26.00 dBm, , -13.00 dBm, , -13.00 dBm, , - 13.00 dBm WCDMA: -12.50 dBm, , -24.50 dBm, , -24.50 dBm, , -11.50 dBm, , -11.50 dBm, , -11.50 dBm  -69.6 dBm, , -54.3 dBm, , -54.3 dBm, , -54.3 dBm, , -54.3 dBm, , -54.3 dBm C2K: -27.00 dBm, , -27.00 dBm, , -27.00 dBm, , -46.00 dBm, , -13.00 dBm, , -13.00 dBm  -70.13 dBm, , -70.13 dBm, , -35.00 dBm, , -13.00 dBm, , -13.00 dBm, , -13.00 dBm TD-SCDMA: -28 dBm, , -36 dBm, , -36 dBm, , -21 dBm, , -21 dBm, , -21 dBm -71.3 dBm, , -71.3 dBm, , -56.07 dBm, , -56.07 dBm, , -56.07 dBm, , -56.07 dBm 1xEVDO: -27dBm, , -27.00 dBm, , -27.00 dBm, , -46.00 dBm, , -13.00 dBm, , -13.00 dBm  -70.13 dBm, , -70.13 dBm, , -70.13 dBm, , -70.13 dBm, , -70.13 dBm, , -70.13 dBm DTMB (CTTB): -14.0 dBm, , -26.0 dBm, , -26.0 dBm, , -13.0 dBm, , -13.0 dBm, , -13.0 dBm   -13.0 dBm, , -13.0 dBm, , -13.0 dBm, , -13.0 dBm, , -13.0 dBm DVB-T/H: -29 dBm, , -41 dBm, , -66 dBm, , -82 dBm, , -82 dBm, , -82 dBm  -82 dBm, , -82 dBm, , -82 dBm, , -82 dBm, , -82 dBm, , -82 dBm ISDB-TCMMB, , Digital Cable TV: 50.0 dBm, , 50.0 dBm, , 50.0 dBm, , 50.0 dBm, , 50.0 dBm  50.0 dBm, , 50.0 dBm, , 50.0 dBm, , 50.0 dBm, , 50.0 dBm, , 50.0 dBm LTE, , LTETDD: -12.5 dBm, , -12.5 dBm, , -15.0 dBm, , -15.0 dBm, , -15.0 dBm, , -15.0 dBm  - 13.5 dBm, , -8.5 dBm, , -11.5 dBm, , -23.5 dBm, , -23.5 dBm, , -23.5 dBm When option N9060A-7FP is installed in these modes, , the preset value of Offset G ~ L is the same as the Offset F value. ----- WLAN:</pre>

---

if Radio Std is 802.11a/g(OFDM/DSSS-OFDM): -4.00 dBm , -12.00 dBm , -24.00 dBm , -24.00 dBm , -24.00 dBm , -24.00 dBm , -24.00 dBm , -24.00 dBm , -24.00 dBm , -24.00 dBm , -24.00 dBm , -24.00 dBm , -24.00 dBm , -24.00 dBm

if Radio Std is 802.11b/g(DSSS/CCK/PBCC): -10 dBm , -30 dBm , -30 dBm , -30 dBm , -30 dBm , -30 dBm , -30 dBm , -30 dBm , -30 dBm , -30 dBm , -30 dBm , -30 dBm , -30 dBm

if Radio Std is 802.11n(20MHz) or 802.11ac(20MHz): -4.00 dBm , -12.00 dBm , -24.00 dBm , -63.00 dBm , -63.00 dBm , -63.00 dBm , -63.00 dBm , -63.00 dBm , -63.00 dBm , -63.00 dBm , -63.00 dBm , -63.00 dBm , -63.00 dBm , -63.00 dBm

if Radio Std is 802.11n(40MHz) or 802.11ac(40MHz): -4.00 dBm , -12.00 dBm , -24.00 dBm , -66.00 dBm , -66.00 dBm , -66.00 dBm , -66.00 dBm , -66.00 dBm , -66.00 dBm , -66.00 dBm , -66.00 dBm , -66.00 dBm , -66.00 dBm , -66.00 dBm

if Radio Std is 802.11ac(80MHz/160MHz): -4.00 dBm , -12.00 dBm , -24.00 dBm , -69.00 dBm , -69.00 dBm , -69.00 dBm , -69.00 dBm , -69.00 dBm , -69.00 dBm , -69.00 dBm , -69.00 dBm , -69.00 dBm , -69.00 dBm , -69.00 dBm

if Radio Std is 802.11ac (80 + 80 MHz): -69.00 dBm , -69.00 dBm , -69.00 dBm , -69.00 dBm , -69.00 dBm , -69.00 dBm , -69.00 dBm , -69.00 dBm , -69.00 dBm , -69.00 dBm , -69.00 dBm , -69.00 dBm , -69.00 dBm , -69.00 dBm

MSR:-12.5 dBm , -24.5 dBm , -11.5 dBm , -15.0 dBm , -15.0 dBm , -15.0 dBm , -15.0 dBm , -15.0 dBm , -15.0 dBm , -15.0 dBm , -15.0 dBm , -15.0 dBm , -15.0 dBm , -15.0 dBm , -15.0 dBm , -15.0 dBm , -15.0 dBm , -15.0 dBm

LTEAFDD , LTEATDD:-12.5 dBm , -12.5 dBm , -15.0 dBm , -15.0 dBm , -15.0 dBm , -15.0 dBm , -15.0 dBm , -15.0 dBm , -15.0 dBm , -15.0 dBm , -15.0 dBm , -15.0 dBm , -15.0 dBm , -15.0 dBm , -13.5 dBm , -8.5 dBm , -11.5 dBm , -23.5 dBm , -23.5 dBm , -23.5 dBm , -23.5 dBm , -23.5 dBm , -23.5 dBm , -23.5 dBm , -23.5 dBm , -23.5 dBm , -23.5 dBm

For modes (except MSR , LTEAFDD , LTEATDD and WLAN) without option N9060A-7FP , the preset value is as follows.

SA,WIMAX OFDMA: ON, OFF, ON, ON, ON, ON, ON  
WCDMA: ON , OFF , ON , ON , ON , ON|ON , ON , ON , ON , ON , ON , ON  
C2K: ON , ON , ON , ON , ON , OFF|ON , ON , ON , ON , ON , ON , OFF  
TD-SCDMA: ON , OFF , ON , ON , ON , ON|ON , ON , ON , ON , ON , ON , ON  
1xEVDO: ON , ON , ON , ON , ON , ON , OFF|ON , ON , ON , ON , ON , ON , OFF  
DTMB (CTTB): ON, OFF, ON, ON, ON, ON, ON  
DVB-T/H , ISDB-T , CMMB , Digital Cable TV: OFF , OFF , OFF , OFF , OFF , OFF , OFF

LTE , LTETDD: OFF , ON , ON , ON , ON , ON , ON|ON , ON , ON , ON , ON , ON , ON

When option N9060A-7FP is installed in these modes , the preset value of Offset G ~ L is the same as the Offset F value.

-----  
WLAN:  
if Radio Std is 802.11a/g(OFDM/DSSS-OFDM)/802.11n(20MHz/40MHz)/802.11 ac (20MHz/40MHz/80MHz/160MHz): OFF , OFF , OFF , ON , ON , ON , ON , ON , ON , ON , ON , ON , ON , ON  
if Radio Std is 802.11 ac(80+80 MHz): ON , ON , ON , ON , ON , ON , ON , ON , ON , ON , ON , ON , ON , ON , ON  
if Radio Std is 802.11b/g(DSSS/CCK/PBCC): ON , ON , ON , ON , ON , ON , ON , ON , ON , ON , ON , ON , ON , ON

---

---

	, ON, , ON MSR: ON, , OFF, , OFF, , OFF, , ON, , OFF, , OFF, , OFF, , OFF, , OFF, , OFF ON, , OFF, , OFF, , OFF, , ON, , OFF, , OFF, , OFF, , OFF, , OFF, , OFF, , OFF, , OFF LTEAFDD, , LTEATDD: OFF, , ON, , ON, , ON, , ON, , ON, , ON, , ON, , ON, , ON, , ON ON, , ON, , ON, , ON, , ON, , ON, , ON, , ON, , ON, , ON, , ON
State Saved	Saved in instrument state.
Min	-200 dBm
Max	50 dBm
Initial S/W Revision	Prior to A.02.00
Modified at S/W Revision	A.02.00, A.03.00, A.10.00, A.11.00, A.14.00

---

### Rel Start

Sets a relative power level limit at the start frequency for the selected offset. The relative power level limit ranges from -200 to +50 dBc.

The fail condition is set remotely by [:SENSE]:SEMASK:OFFSet[n][:OUTer]:LIST:TEST for each offset channel test.

You can turn off (not use) specific offset channels remotely with [:SENSE]:SEMASK:OFFSet[n][:OUTer]:LIST:STATE.

The SCPI query returns values currently set to the relative power test limits.

Missing values are not permitted; that is, if you want to change values 2 and 6, you must send all values up to 6. Subsequent values will remain as they were. The query for this parameter always returns 12 values.

---

Key Path	Meas Setup, Offset/Limits, Limits
Mode	SA, WCDMA, C2K, WIMAX OFDMA, TD-SCDMA, 1xEVDO, DTMB (CTTB), DVB-T/H, ISDB-T, CMMB, LTE, LTE-TDD, Digital Cable TV, WLAN, MSR, LTEAFDD, LTEATDD
Remote Command	[:SENSE]:SEMASK:OFFSet[1] 2[:OUTer]:LIST:STARt:RCARrier <rel_ampl>, ... [:SENSE]:SEMASK:OFFSet[1] 2[:OUTer]:LIST:STARt:RCARrier?
Example	SEM:OFFS:LIST:STAR:RCAR -30,, -30,, -30,, -30,, -30,, -30 SEM:OFFS:LIST:STAR:RCAR?
Notes	Comma separated list of values. OFFSet1 is for BTS, 2 for MS. Default is BTS. You must be in the mode that includes SEM measurement to use this command. Use :INSTrument:SElect to set the mode.
Couplings	If the current mode is DVB-T/H, this value will be modified automatically according to the limit type the output power of the transmitter which is less or more than 25W. If the current mode is ISDB-T, this value will be modified automatically according to the limit type. If the current mode is WLAN and radio std is 802.11n, Rel Start limits will be set to following values

---

---

when frequency changed to above 5GHz:

0 dB, -20.00 dB, -28.00 dB, -40.00 dB, -40.00 dB, -40.00 dB, -40.00 dB, -40.00 dB, -40.00 dB, -40.00 dB, -40.00 dB, -40.00 dB

---

Preset

For modes (except MSR, LTEAFDD, LTEATDD and WLAN) without option N9060A-7FP, the preset value is as follows.

SA: -30.00 dB, -30.00 dB, -30.00 dB, -30.00 dB, -30.00 dB, -30.00 dB

WCDMA: -30.00 dB, -30.00 dB, -30.00 dB, -30.00 dB, -30.00 dB, -30.00 dB|-33.73 dB, -34.00 dB, -37.50 dB, -47.50 dB, -47.50 dB, -47.50 dB

C2K: -45.00 dB, -45.00 dB, -55.00 dB, -55.00 dB, -55.00 dB, -55.00 dB|-42.00 dB, -54.00 dB, -54.00 dB, -54.00 dB, -54.00 dB, -54.00 dB

WIMAX OFDMA: 0 dB, -25 dB, -32 dB, -50 dB, -50 dB, -50 dB

TD-SCDMA: -54.00 dB, -54.00 dB, -62.00 dB, -47.00 dB, -47.00 dB, -47.00 dB|-35.21 dB, -49.00 dB, -44.00 dB, -44.00 dB, -44.00 dB, -44.00 dB

1xEVDO: -45dBc, -45.00 dB, -55.00 dB, -55.00 dB, -55.00 dB, -55.00 dB|-42dBc, -54.00 dB, -54.00 dB, -54.00 dB, -54.00 dB, -54.00 dB

DTMB (CTTB): -32.8 dB, -83 dB, -95 dB, -120 dB, -120 dB, -120 dB|-120 dB, -120 dB, -120 dB, -120 dB, -120 dB, -120 dB

DVB-T/H: -30 dB, -30 dB, -30 dB, -30 dB, -30 dB, -30 dB|-30 dB, -30 dB, -30 dB, -30 dB, -30 dB, -30 dB

ISDB-T: -27.4 dB, -47.4 dB, -54.4 dB, XXX, 50 dB, 50 dB | 50 dB, 50 dB, 50 dB, 50 dB, 50 dB, 50 dB; XXX is coupled with the total power reference, it is -57.4 dB when  $P \leq 0.025 W$ , -67.4 dB when  $P = 0.25 W$ ,  $-(73.4 + 10 \log P)$  dB when  $0.25 W < P \leq 2.5 W$  or  $0.025 W < P < 0.25 W$ , -77.4 dB when  $P > 2.5 W$ .

CMMB: -37 dB, -72 dB, -84 dB, -90 dB, -90 dB, -90 dB|-90 dB, -90 dB, -90 dB, -90 dB, -90 dB, -90 dB

LTE, LTEATDD: 0 dB, 0 dB, 0 dB, 0 dB, 0 dB, 0 dB | 0 dB, 0 dB, 0 dB, 0 dB, 0 dB, 0 dB

Digital Cable TV: 0 dB, 0 dB, 0 dB, 0 dB, 0 dB, 0 dB | 0 dB, 0 dB, 0 dB, 0 dB, 0 dB, 0 dB

When option N9060A-7FP is installed in these modes, the preset value of Offset G ~ L is the same as the Offset F value.

-----

WLAN:

if Radio Std is 802.11a/g(OFDM/DSSS-OFDM): 0 dB, -20.00 dB, -28.00 dB, -40.00 dB, -40.00 dB, -47.00 dB, -47.00 dB, -47.00 dB, -47.00 dB, -47.00 dB, -47.00 dB, -47.00 dB

if Radio Std is 802.11b/g(DSSS/CCK/PBCC): -30 dB, -50 dB, -50 dB, -50 dB, -50 dB, -50 dB, -50 dB, -50 dB, -50 dB, -50 dB, -50 dB, -50 dB

if Radio Std is 802.11n(20MHz/40MHz): 0 dB, -20.00 dB, -28.00 dB, -45.00 dB, -45.00 dB, -45.00 dB, -45.00 dB, -45.00 dB, -45.00 dB, -45.00 dB, -45.00 dB, -45.00 dB

if Radio Std is 802.11ac (20 MHz/ 40 MHz/ 80 MHz/ 160 MHz): 0 dB, -20.00 dB, -28.00 dB, -40.00 dB, -40.00 dB, -40.00 dB, -40.00 dB, -40.00 dB, -40.00 dB, -40.00 dB, -40.00 dB, -40.00 dB

if Radio Std is 802.11ac(80 MHz + 80MHz): -40.00 dB, -28.00 dB, -20 dB, 0 dB, -20 dB, -28 dB, -40 dB, -40 dB, -40.00 dB, -40.00 dB, -40.00 dB, -40.00 dB

MSR, LTEAFDD, LTEATDD: 0 dB, 0 dB, 0 dB, 0 dB, 0 dB, 0 dB, 0 dB, 0 dB, 0 dB, 0 dB, 0 dB, 0 dB

---

	0 dB, , 0 dB 0 dB, , 0 dB, , 0 dB, , 0 dB, , 0 dB, , 0 dB, , 0 dB, , 0 dB, , 0 dB, , 0 dB
State Saved	Saved in instrument state.
Min	-200 dB
Max	50 dB
Initial S/W Revision	Prior to A.02.00
Modified at S/W Revision	A.02.00, A.03.00, A.10.00, A.11.00, A.14.00

## Rel Stop

Sets a relative power level limit at the stop frequency for the selected offset. The relative power level limit ranges from -200 to +50 dBc.

The fail condition is set remotely by [:SENSe]:SEMAsk:OFFSet[n][:OUTer]:LIST:TEST for each offset channel.

You can turn off (not use) specific offset channels remotely with [:SENSe]:SEMAsk:OFFSet[n][:OUTer]:LIST:STATe.

The SCPI query returns values currently set to the offset stop relative power limits.

Missing values are not permitted; that is, if you want to change values 2 and 6, you must send all values up to 6. Subsequent values will remain as they were. The query for this parameter always returns 12 values.

Key Path	Meas Setup, Offset/Limits, Limits
Mode	SA, WCDMA, C2K, WIMAX OFDMA, TD-SCDMA, 1xEVDO, DTMB (CTTB), DVB-T/H, ISDB-T, CMMB, LTE, LTEFDD, Digital Cable TV, WLAN, MSR, LTEAFDD, LTEATDD
Remote Command	[:SENSe]:SEMAsk:OFFSet[1] 2[:OUTer]:LIST:STOP:RCARrier <rel_ampl>, ... [:SENSe]:SEMAsk:OFFSet[1] 2[:OUTer]:LIST:STOP:RCARrier? [:SENSe]:SEMAsk:OFFSet[1] 2[:OUTer]:LIST:STOP:RCARrier:COUPle ON   OFF   1   0, ... [:SENSe]:SEMAsk:OFFSet[1] 2[:OUTer]:LIST:STOP:RCARrier:COUPle?
Example	SEM:OFFS:LIST:STOP:RCAR -30, , -30, , -30, , -30, , -30, , -30 SEM:OFFS:LIST:STOP:RCAR? SEM:OFFS:LIST:STOP:RCAR:COUP ON, , ON, , ON, , ON, , ON SEM:OFFS:LIST:STOP:RCAR:COUP?
Notes	Comma separated list of values. OFFSet1 is for BTS, 2 for MS. Default is BTS. You must be in the mode that includes SEM measurement to use this command. Use :INSTrument:SElect to set the mode.
Couplings	Coupled to Rel Start if "Auto" is selected, that is, Start is made the same as Stop. If the current mode is DVB-T/H, this value will be modified automatically according to the limit type and the output power of the transmitter which is less or more than 25W. If the current mode is ISDB-T, this value will be modified automatically according to the limit type.

---

If the current mode is WLAN and radio std is 802.11n, Rel Stop limits will be set to following values when frequency changed to above 5GHz:

-20.00 dB, -28.00 dB, -40.00 dB, -40.00 dB, -40.00 dB, -40.00 dB, -40.00 dB, -40.00 dB, -40.00 dB, -40.00 dB, -40.00 dB, -40.00 dB

---

Preset

For modes (except MSR, LTEAFDD, LTEATDD and WLAN) without option N9060A-7FP, the preset value is as follows.

SA: -30.00 dB, -30.00 dB, -30.00 dB, -30.00 dB, -30.00 dB, -30.00 dB

WCDMA: -30.00 dB, -30.00 dB, -30.00 dB, -30.00 dB, -30.00 dB, -30.00 dB|-48.28 dB, -37.50 dB, -47.50 dB, -47.50 dB, -47.50 dB, -47.50 dB

C2K: -45.00 dB, -45.00 dB, -55.00 dB, -55.00 dB, -55.00 dB, -55.00 dB|-42.00 dB, -54.00 dB, -54.00 dB, -54.00 dB, -54.00 dB, -54.00 dB

WIMAX OFDMA: -25 dB, -32 dB, -50 dB, -50 dB, -50 dB, -50 dB

TD-SCDMA: -54.00 dB, -62.00 dB, -62.00 dB, -47.00 dB, -47.00 dB, -47.00 dB|-49.00 dB, -58.945 dB, -44.00 dB, -44.00 dB, -44.00 dB, -44.00 dB

1xEVDO: -45dB, -45.00 dB, -55.00 dB, -55.00 dB, -55.00 dB, -55.00 dB|-42dB, -54.00 dB, -54.00 dB, -54.00 dB, -54.00 dB, -54.00 dB

DTMB (CTTB): -83 dB, -95 dB, -120 dB, -120 dB, -120 dB, -120 dB|-120 dB, -120 dB, -120 dB, -120 dB, -120 dB, -120 dB

DVB-T/H: -73 dB, -85 dB, -110 dB, -126 dB, -126 dB, -126 dB|-126 dB, -126 dB, -126 dB, -126 dB, -126 dB, -126 dB

ISDB-T: -47.4 dB, -54.4 dB, XXX, 50 dB, 50 dB, 50 dB|50 dB, 50 dB, 50 dB, 50 dB, 50 dB, 50 dB, 50 dB; XXX is coupled with the total power reference P, it is -57.4 dB when  $P <= 0.025 W$ , -67.4 dB when  $P = 0.25 W$ ,  $-(73.4 + 10\log P)$  dB when  $0.25 W < P <= 2.5 W$  or  $0.025 W < P < 0.25 W$ , -77.4 dB when  $P > 2.5 W$ .

CMMB: -72 dB, -84 dB, -90 dB, -90 dB, -90 dB, -90 dB|-90 dB, -90 dB, -90 dB, -90 dB, -90 dB, -90 dB

LTE, LTETDD: 0 dB, 0 dB, 0 dB, 0 dB, 0 dB, 0 dB

Digital Cable TV: 0 dB, 0 dB, 0 dB, 0 dB, 0 dB, 0 dB|0 dB, 0 dB, 0 dB, 0 dB, 0 dB, 0 dB

When option N9060A-7FP is installed in these modes, the preset value of Offset G ~ L is the same as the Offset F value.

-----

WLAN:

if Radio Std is 802.11a/g(OFDM/DSSS-OFDM): -20.00 dB, -28.00 dB, -40.00 dB, -40.00 dB, -47.00 dB, -47.00 dB, -47.00 dB, -47.00 dB, -47.00 dB, -47.00 dB, -47.00 dB, -47.00 dB

if Radio Std is 802.11b/g(DSSS/CCK/PBCC): -30 dB, -50 dB, -50 dB, -50 dB, -50 dB, -50 dB, -50 dB, -50 dB, -50 dB, -50 dB, -50 dB, -50 dB

if Radio Std is 802.11n(20MHz/40MHz): -20.00 dB, -28.00 dB, -45.00 dB, -45.00 dB, -45.00 dB, -45.00 dB, -45.00 dB, -45.00 dB, -45.00 dB, -45.00 dB, -45.00 dB, -45.00 dB

if Radio Std is 802.11ac (20 MHz/ 40 MHz/ 80 MHz/ 160 MHz): -20.00 dB, -28.00 dB, -40.00 dB, -40.00 dB, -40.00 dB, -40.00 dB, -40.00 dB, -40.00 dB, -40.00 dB, -40.00 dB, -40.00 dB, -40.00 dB

if Radio Std is 802.11ac(80 MHz + 80MHz): -28.00 dB, -20.00 dB, 0 dB, -20.00 dB, -28.00

---

dB, , -40.00 dB, , -40.00 dB, , -40.00 dB, , -40.00 dB, , -40.00 dB, , -40.00 dB, , -40.00 dB

MSR, , LTEAFDD, , LTEATDD: 0 dB, , 0 dB, , 0 dB, , 0 dB, , 0 dB, , 0 dB, , 0 dB, , 0 dB, , 0 dB, ,  
0 dB, , 0 dB|0 dB, , 0 dB, , 0 dB, , 0 dB, , 0 dB, , 0 dB, , 0 dB, , 0 dB, , 0 dB, , 0 dB, , 0 dB, , 0 dB

For modes (except MSR, , LTEAFDD, , LTEATDD and WLAN) without option N9060A-7FP, , the preset value is as follows.

For modes (except MSR, , LTEAFDD, , LTEATDD and WLAN) with option N9060A-7FP, , the preset value of Offset G ~ L is the same as the Offset F value.

SA: ON, ON, ON, ON, ON, ON, ON  
 WCDMA: ON, , ON, , ON, , ON, , ON|OFF, , OFF, , OFF, , ON, , ON, , ON  
 C2K: ON, , ON, , ON, , ON, , OFF|ON, , ON, , ON, , ON, , OFF  
 WIMAX OFDMA: OFF, , OFF, , OFF, , ON, , ON, , ON|OFF, , OFF, , OFF, , ON, , ON, , ON  
 TD-SCDMA: ON, , OFF, , ON, , ON, , ON|OFF, OFF, ON, ON, ON, ON  
 1xEVDO: ON, , ON, , ON, , ON, , ON, , OFF|ON, , ON, , ON, , ON, , OFF  
 DTMB (CTTB): OFF, , OFF, , OFF, , OFF, , OFF, , OFF  
 DVB-T/H: ON, ON, ON, ON, ON, ON, ON  
 ISDB-T: OFF, OFF, OFF, OFF, OFF, OFF, OFF  
 CMMB: OFF, OFF, OFF, OFF, OFF, OFF, OFF  
 LTE, LTE-TDD: ON, ON, ON, ON, ON, ON, ON  
 Digital Cable TV: OFF, , OFF, , OFF, , OFF, , OFF, , OFF

-----  
 WLAN:  
 if Radio Std is 802.11a/g(OFDM/DSSS-OFDM)/802.11n(20MHz/40MHz): OFF, , OFF, , OFF, , ON, , ON, , ON, , ON, , ON, , ON, , ON, , ON  
 if Radio Std is 802.11b/g(DSSS/CCK/PBCC): ON, , ON, , ON, , ON, , ON, , ON, , ON, , ON, , ON, , ON, , ON, , ON, , ON  
 if Radio Std is 802.11ac (20 MHz/ 40 MHz/ 80 MHz/ 160 MHz): OFF, , OFF, , OFF, , ON, , ON, , ON, , ON, , ON, , ON, , ON, , ON  
 if Radio Std is 802.11ac(80 MHz + 80MHz): OFF, , OFF, , OFF, , OFF, , OFF, , OFF, , OFF, , OFF, , OFF, , OFF, , OFF, , OFF  
 MSR, , LTEAFDD, , LTEATDD: ON, , ON, , ON, , ON, , ON, , ON, , ON, , ON, , ON, , ON, , ON |  
 ON, , ON, , ON, , ON, , ON, , ON, , ON, , ON, , ON, , ON, , ON

---

State Saved	Saved in instrument state.
Min	-200 dB
Max	50 dB
Initial S/W Revision	Prior to A.02.00
Modified at S/W Revision	A.02.00, A.03.00, A.10.00, A.11.00, A.14.00

---

### Fail Mask

Selects one of the logic keys for fail conditions between the measurement results and the test limits:

- Absolute and Relative both check the results against the respective limit.

- OR checks against both limits, failing if either of the limits is broken.
- AND will only display a fail if both of the limits are broken.

The absolute or relative power limit value for each offset channel can be set remotely with [:SENSe]:SEMAsk:OFFSet[n][:OUTer]:LIST:ABSolute or [:SENSe]:SEMAsk:OFFSet[n][:OUTer]:LIST:RCARrier.

You can turn off (not use) specific offset channels remotely with [:SENSe]:SEMAsk:OFFSet[n][:OUTer]:LIST:STATe.

Missing values are not permitted; that is, if you want to change values 2 and 6, you must send all values up to 6. Subsequent values will remain as they were. The query for this parameter always returns 12 values.

Key Path	Meas Setup, Offset/Limits, Limits
Mode	SA, WCDMA, C2K, WIMAX OFDMA, TD-SCDMA, 1xEVDO, DTMB (CTTB), DVB-T/H, ISDB-T, CMMB, LTE, LTETDD, Digital Cable TV, WLAN, MSR, LTEAFDD, LTEATDD
Remote Command	[:SENSe]:SEMAsk:OFFSet[1] 2[:OUTer]:LIST:TEST ABSolute   AND   OR   RELative, ... [:SENSe]:SEMAsk:OFFSet[1] 2[:OUTer]:LIST:TEST?
Example	SEM:OFFS:LIST:TEST ABS, , ABS, , ABS, , ABS, , ABS, , ABS SEM:OFFS:LIST:TEST?
Notes	Comma separated list of values. You must be in the mode that includes SEM measurement to use this command. Use :INSTrument:SElect to set the mode.
Couplings	None If the current mode is DVB-T/H, this value will be modified automatically according to the limit type and the output power of the transmitter which is less or more than 25W.
Preset	For modes (except MSR, LTEAFDD, LTEATDD and WLAN) without option N9060A-7FP, the preset value is as follows. SA: ABS, ABS, ABS, ABS, ABS, ABS WCDMA: ABS, , ABS, , ABS, , ABS, , ABS AND, , AND, , AND, , AND, , AND, , AND C2K: REL, , REL, , REL, , ABS, , REL, , REL AND, , AND, , ABS, , REL, , REL, , REL WIMAX OFDMA: REL, , REL, , REL, , REL, , REL REL, , REL, , REL, , REL, , REL, , REL TD-SCDMA: ABS, , ABS, , ABS, , ABS, , ABS AND, , AND, , AND, , AND, , AND, , AND 1xEVDO: REL, , REL, , REL, , ABS, , REL, , REL AND, , AND, , AND, , OR, , AND, , AND DTMB (CTTB), ISDB-T, CMMB: REL, , REL, , REL, , REL, , REL, , REL   REL, , REL, , REL, , REL, , REL, , REL DVB-T/H: ABS, , ABS, , ABS, , ABS, , ABS, , ABS   ABS, , ABS, , ABS, , ABS, , ABS, , ABS LTE, , LTETDD: ABS, , ABS, , ABS, , ABS, , ABS, , ABS Digital Cable TV: REL, , REL, , REL, , REL, , REL, , REL   REL, , REL, , REL, , REL, , REL, , REL When option N9060A-7FP is installed in these modes, the preset value of Offset G ~ L is the same as the Offset F value. ----- WLAN:





10 Spectrum Emission Mask Measurement  
Meas Setup

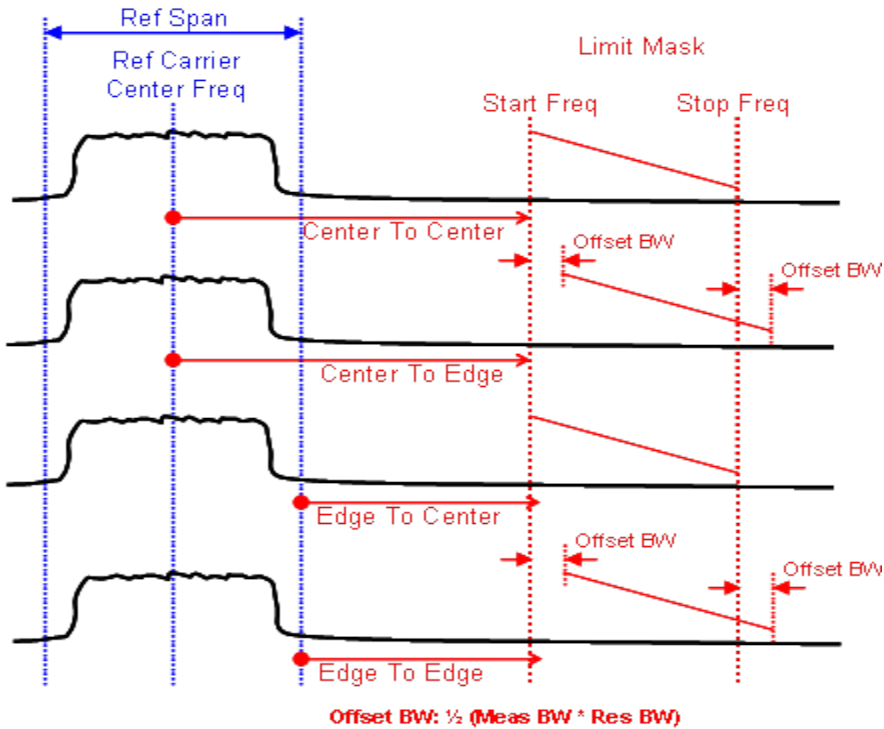
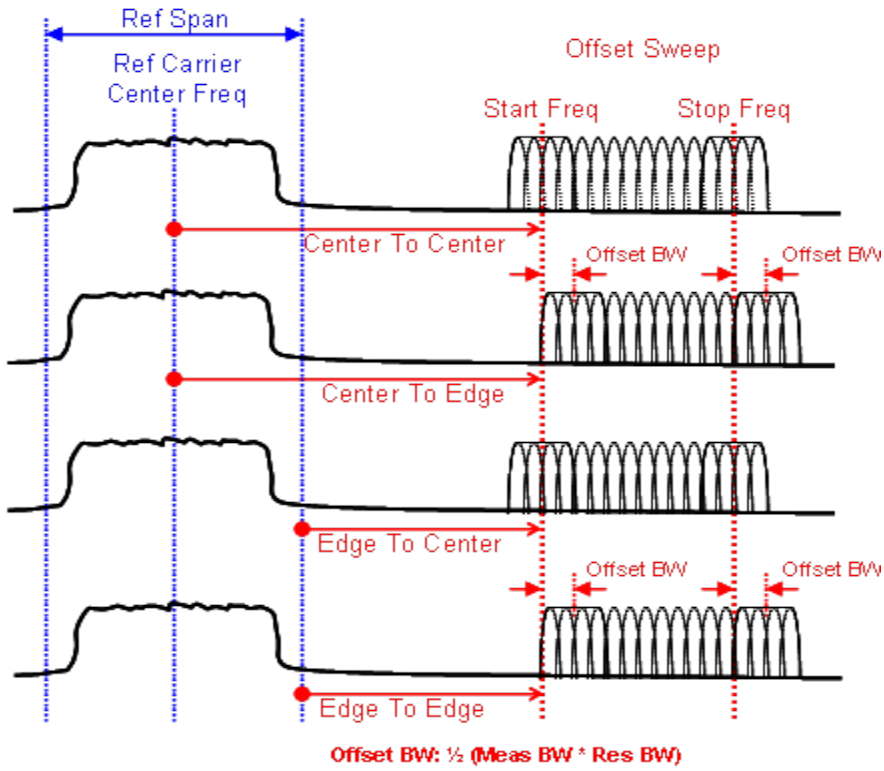

Key Path	Meas Setup, Offset/Limits
Mode	SA, WCDMA, C2K, WIMAX OFDMA, TD-SCDMA, 1xEVDO, DVB-T/H, DTMB (CTTB), ISDB-T, CMMB, LTE, LTETDD, Digital Cable TV, WLAN
Remote Command	<code>[ :SENSE ] :SEMask:OFFSet [ 1 ]   2 :TYPE CTOCenter   CTOEdge   ETOCenter   ETOEdge</code> <code>[ :SENSE ] :SEMask:OFFSet [ 1 ]   2 :TYPE ?</code>
Example	SEM:OFFS:TYPE ETOC SEM:OFFS:TYPE?
Notes	You must be in the mode that includes SEM measurements to use this command. Use <code>:INSTRument:SElect</code> to set the mode. For the MSR and LTE-Advanced FDD/TDD mode, see <a href="#">Offset Freq Define (Only for MSR and LTE-Advanced FDD/TDD)</a> .
Preset	SA, , WCDMA, , WIMAX OFDMA, , TD-SCDMA, , DVB-T/H, , DTMB (CTTB), , ISDB-T, , CMMB, , Digital Cable TV: CTOC C2K: CTOE 1xEVDO: CTOE LTE: ETOC LTETDD: ETOC
State Saved	Saved in instrument state.
Range	Carrier Center To Meas BW Center Carrier Center To Meas BW Edge Carrier Edge To Meas BW Center Carrier Edge To Meas BW Edge
Initial S/W Revision	A.03.00

## Method

Sets the measurement method:

- **Integ BW**—enables you to set the channel integration bandwidth.
- **RRC Weight**—selects Root Raised Cosine (RRC) filtering of the carriers. The  $\alpha$  value (rolloff) for the filter is set to the value of the Filter Alpha parameter.

Key Path	Meas Setup
Mode	SA, WCDMA, WIMAX OFDMA, TD-SCDMA, DTMB (CTTB), DVB-T/H, ISDB-T, CMMB, LTE, LTETDD, Digital Cable TV, WLAN, MSR, LTEAFDD, LTEATDD
Remote Command	<code>[ :SENSE ] :SEMask:FILTer [ :RRC ] [ :STATe ] OFF   ON   0   1</code> <code>[ :SENSE ] :SEMask:FILTer [ :RRC ] [ :STATe ] ?</code>
Example	SEM:FILT ON SEM:FILT?
Notes	For the C2K and 1xEVDO mode, this key is not available. 1 ON = RRC Weight, 0 OFF = IntegBW You must be in the mode that includes SEM measurement to use this command. Use

	:INSTrument:SElect to set the mode.
Dependencies	WLAN: RRC Weight is not supported when the radio standard is WLAN 802.11ac (80+80MHz).
Preset	SA, , WIMAX OFDMA, , DVB-T/H, , ISDB-T, , CMMB, , LTE, , LTETDD, , WLAN, , MSR, , LTEAFDD, , LTEATDD: OFF WCDMA, , TD-SCDMA, , DTMB (CTTB), , Digital Cable TV: ON
State Saved	Saved in instrument state.
Range	RRCWeight IntegBW
Initial S/W Revision	Prior to A.02.00
Modified at S/W Revision	A.02.00, A.03.00

## Filter Alpha

Sets the alpha value for the RRC Filter.

Key Path	Meas Setup
Mode	SA, WCDMA, WIMAX OFDMA, TD-SCDMA, DTMB (CTTB), DVB-T/H, ISDB-T, CMMB, LTE, LTETDD, Digital Cable TV, MSR, LTEAFDD, LTEATDD
<b>Remote Command</b>	[ :SENSe ] :SEMAsk:FILTEr [ :RRC ] :ALPHa <real> [ :SENSe ] :SEMAsk:FILTEr [ :RRC ] :ALPHa?
<b>Example</b>	SEM:FILT:ALPH 0.3 SEM:FILT:ALPH?
Notes	For the C2K and 1xEVDO mode, this key is not available. You must be in the mode that includes SEM measurement to use this command. Use :INSTrument:SElect to set the mode.
Preset	0.22 DTMB (CTTB): 0.05 Digital Cable TV: 0.15
State Saved	Saved in instrument state.
Min	0.01
Max	1.0
Initial S/W Revision	Prior to A.02.00
Modified at S/W Revision	A.02.00, A.03.00

## Meas Preset

Restores all the measurement parameters to their default values.

Key Path	Meas Setup
Mode	SA, WCDMA, C2K, WIMAX OFDMA, TD-SCDMA, 1xEVDO, DTMB (CTTB), DVB-T/H, ISDB-T, CMMB,

	LTE, LTE-TDD, Digital Cable TV, WLAN, MSR, LTE-AFDD, LTE-TDD
<b>Remote Command</b>	:CONFigure:SEMask
<b>Example</b>	CONF:SEM
<b>Notes</b>	You must be in the mode that includes SEM measurement to use this command. Use :INSTrument:SElect to set the mode.
<b>Couplings</b>	Selecting Meas Preset will restore all measurement parameters to their default values.
<b>Initial S/W Revision</b>	Prior to A.02.00
<b>Modified at S/W Revision</b>	A.02.00, A.03.00

## Mode

See "Mode" on page 140

## Mode Preset

Returns the active mode to a known state.

Mode Preset does the following for the currently active mode:

- Aborts the currently running measurement.
- Brings up the default menu for the mode, with no active function.
- Sets measurement Global settings to their preset values for the active mode only.
- Activates the default measurement.
- Brings up the default menu for the mode.
- Clears the input and output buffers.
- Sets Status Byte to 0.

Mode Preset does not:

- Cause a mode switch
- Affect mode persistent settings
- Affect system settings
- See "[How-To Preset](#)" on page 996 for more information.

Key Path	Front-panel key
<b>Remote Command</b>	:SYSTem:PRESet
<b>Example</b>	:SYST:PRES
Notes	*RST is preferred over :SYST:PRES for remote operation. *RST does a Mode Preset, as done by the :SYST:PRES command, and it sets the measurement mode to Single measurement rather than Continuous for optimal remote control throughput. Clears all pending OPC bits. The Status Byte is set to 0.
Couplings	A Mode Preset aborts the currently running measurement, activates the default measurement, and gets the mode to a consistent state with all of the default couplings set.
Backwards Compatibility Notes	In the X-Series, the legacy "Factory Preset" has been replaced with Mode Preset, which only presets the currently active mode, not the entire instrument. In the X-Series, the way to preset the entire instrument is by using System, Restore System Defaults All, which behaves essentially the same way as restore System Defaults does on ESA and PSA. There is also no "Preset Type" as there is on the PSA. There is a green Mode Preset front-panel key that does a Mode Preset and a white-with-green-letters User Preset front-panel key that does a User Preset. The old PRESet:TYPE command is ignored (without generating an error), and SYST:PRES without a parameter does a Mode Preset, which should cover most backward code compatibility issues. The settings and correction data under the Input/Output front-panel key (examples: Input Z Corr, Ext Amp Gain, etc.) are no longer part of any Mode, so they will not be preset by a Mode Preset. They are preset using Restore Input/Output Defaults, Restore System Defaults All. Note that because User Preset does a Recall State, and all of these settings are saved in State, they ARE recalled when using

	User Preset.
Initial S/W Revision	Prior to A.02.00

## How-To Preset

The table below shows all possible presets, their corresponding SCPI commands and front-panel access (key paths). Instrument settings depend on the current measurement context. Some settings are local to the current measurement, some are global (common) across all the measurements in the current mode, and some are global to all the available modes. In a similar way, restoring the settings to their preset state can be done within the different contexts.

Auto Couple - is a measurement local key. It sets all Auto/Man parameter couplings in the measurement to Auto. Any Auto/Man selection that is local to other measurements in the mode will not be affected.

Meas Preset - is a measurement local key. Meas Preset resets all the variables local to the current measurement except the persistent ones.

Mode Preset - resets all the current mode's measurement local and measurement global variables except the persistent ones.

Restore Mode Defaults - resets ALL the Mode variables (and all the Meas global and Meas local variables), including the persistent ones.

Type Of Preset	SCPI Command	Front Panel Access
Auto Couple	:COUPle ALL	Auto Couple front-panel key
Meas Preset	:CONFigure:<Measurement>	Meas Setup Menu
Mode Preset	:SYSTem:PRESet	Mode Preset (green key)
Restore Mode Defaults	:INSTrument:DEFault	Mode Setup Menu
Restore All Mode Defaults	:SYSTem:DEFault MODes	System Menu; Restore System Default Menu
*RST	*RST	not possible (Mode Preset with Single)
Restore Input/Output Defaults	:SYSTem:DEFault INPUt	System Menu; Restore System Default Menu
Restore Power On Defaults	:SYSTem:DEFault PON	System Menu; Restore System Default Menu
Restore Alignment Defaults	:SYSTem:DEFault ALIGN	System Menu; Restore System Default Menu
Restore Miscellaneous Defaults	:SYSTem:DEFault MISC	System Menu; Restore System Default Menu
Restore All System Defaults	:SYSTem:DEFault [ALL] :SYSTem:PRESet:PERsistent	System Menu; Restore System Default Menu
User Preset	:SYSTem:PRESet:USER	User Preset Menu
User Preset All Modes	:SYSTem:PRESet:USER:ALL	User Preset Menu



Power On Mode Preset	:SYSTem:PON:TYPE MODE	System Menu
Power On User Preset	:SYSTem:PON:TYPE USER	System Menu
Power On Last State	:SYSTem:PON:TYPE LAST	System Menu

## Mode Setup

See "[Mode Setup](#)" on page 159

## Peak Search

There is no 'Peak Search' supported in Spectrum Emission Mask so this front-panel key displays a blank menu when pressed.

---

Key Path	Front-panel key
Initial S/W Revision	Prior to A.02.00

---

10 Spectrum Emission Mask Measurement  
Print

Print

See "[Print](#) " on page 183

## Quick Save

The Quick Save front-panel key repeats the most recent save that was performed from the Save menu, with the following exceptions:

- Register saves are not remembered as Saves for the purpose of the Quick Save function
- If the current measurement does not support the last non-register save that was performed, an informational message is generated, “File type not supported for this measurement”

Quick Save repeats the last type of qualified save (that is, a save qualified by the above criteria) in the last save directory by creating a unique filename using the Auto File Naming algorithm described below.

If Quick Save is pressed after startup and before any qualified Save has been performed, the Quick Save function performs a Screen Image save using the current settings for Screen Image saves (current theme, current directory), which then becomes the “last save” for the purpose of subsequent Quick Saves.

The Auto File Naming feature automatically generates a file name for use when saving a file. The filename consists of a prefix and suffix separated by a dot, as is standard for the Windows® file system. A default prefix exists for each of the available file types:

Type	Default Prefix	Menu
State	State_	(Save/Recall)
Trace + State	State_	(Save/Recall)
Screen	Screen_	(Save/Recall)
Amplitude Corrections	Ampcor_	(Import/Export)
Traces	Trace_	(Import/Export)
Limit Lines	LLine_	(Import/Export)
Measurement Result	MeasR_	(Import/Export)
Capture Buffer	CapBuf_	(Import/Export)

A four digit number is appended to the prefix to create a unique file name. The numbering sequence starts at 0000 within each Mode for each file type and updates incrementally to 9999, then wraps to 0000 again. It remembers where it was through a Mode Preset and when leaving and returning to the Mode. It is reset by Restore Misc Defaults and Restore System Defaults and subsequent running of the instrument application. So, for example, the first auto file name generated for State files is State\_0000.state. The next is State\_0001, and so forth.

One of the key features of Auto File Name is that we guarantee that the Auto File Name will never conflict with an existing file. The algorithm looks for the next available number. If it gets to 9999, then it looks for holes. If it find no holes, that is no more numbers are available, it gives an error.

For example, if when we get to State\_0010.state there is already a State\_0010.state file in the current directory, it advances the counter to State\_0011.state to ensure that no conflict will exist (and then it verifies that State\_0011.state also does not exist in the current directory and advances again if it does, and so forth).

If you enter a file name for a given file type, then the prefix becomes the filename you entered instead of the default prefix, followed by an underscore. The last four letters (the suffix) are the 4-digit number.

For example, if you save a measurement results file as “fred.csv”, then the next auto file name chosen for a measurement results save will be fred\_0000.csv.

**NOTE**

Although 0000 is used in the example above, the number that is used is actually the current number in the Meas Results sequence, that is, the number that would have been used if you had not entered your own file name.

---

**NOTE**

If the filename you entered ends with \_dddd, where d=any number, making it look just like an auto file name, then the next auto file name picks up where you left off with the suffix being dddd + 1.

---

Key Path	Front-panel key
Notes	No remote command for this key specifically.
Initial S/W Revision	Prior to A.02.00

## Recall

The Recall menu lets you choose what you want to recall, and where you want to recall it from. Among the types of files you can recall are **States and Traces**. In addition, an Import (Data) option lets you recall a number of data types stored in CSV files (as used by Excel and other spreadsheet programs).

**NOTE**

In products that run multiple instances of the X-Series Application, all instances share the same register and file location where you want to recall from.

The default paths for Recall are data type dependent and are the same as for the Save key.

Key Path	Front-panel key
Notes	<p>No remote command for this key specifically, but the :MMEM:LOAD command is available for specific file types. An example is :MMEM:LOAD:STATE &lt;filename&gt;.</p> <p>If you try to recall a State file for a mode that is not licensed or not available in the instrument, an error message will occur and the state will not change.</p>
Backwards Compatibility Notes	<p>In legacy analyzers, it was possible to load a state without affecting the trace data, limit lines or correction data. Similarly (since User Preset is actually loading a state), it was possible to do a User Preset without affecting the trace data, limit lines or correction data.</p> <p>In the X-Series, “state” always includes all of this data; so whenever state is loaded, all of the traces, limit lines and corrections are affected. Although this differs from previous behavior, it is desirable behavior, and should not cause adverse issues for users.</p>
Backwards Compatibility Notes	<p>Recall for the X-Series supports backward compatibility in the sense that you can recall a state file from any X-Series model number and any version of X-Series software. This is only possible if part of the recalling process goes through a limiting step after recalling the mode settings, at least for settings that may vary with version number, model number, option and license differences. If you try to recall a state file onto an instrument with less capability than what was available on the instrument during the save, the recall will ignore the state it doesn't support and it will limit the recalled setting to what it allows.</p> <p>Example: if the saved state includes preamp ON, but the recalling instrument does not have a preamp; the preamp is limited to OFF. Conversely, if you save a state without a preamp, the preamp is OFF in the state file. When this saved file is recalled on an instrument with a licensed preamp, the preamp is changed to OFF. Another example is if the saved state has center frequency set to 20 GHz, but the instrument recalling the saved state is a different model and only supports 13.5 GHz. In this case, the center frequency is limited along with any other frequency based settings. Since the center frequency can't be preserved in this case, the recall limiting tries to at least preserve span to keep the measurement setup as intact as possible.</p> <p>It may be appropriate to issue a warning if the state is limited on the recall; warnings do not go out to SCPI so this would only affect the manual user.</p> <p>Note that there is no state file compatibility outside of the X-Series. For example, you cannot recall a state file from ESA or PSA.</p>
Initial S/W Revision	Prior to A.02.00

## State

The Recall State menu lets you choose a register or file from which to recall the state.

The content of a state file includes all of the settings and data required to return the analyzer as closely as possible to the Mode it was in, with the exact settings that were in place, when the save occurred. The Mode settings in each state file include the settings that are affected by Mode Preset, as well as the additional settings affected by Restore Mode Defaults; all of the Mode's settings. In addition, all of the settings of the Input/Output system are included, even though they are outside of the Mode's state, because they are needed to restore the complete setup. Persistent System settings (for example, GPIB address) are not affected by either a Mode Preset or Restore Mode Defaults, nor are they included in a saved State file.

Since each state file is only for one Mode, the settings for other Modes are unaffected when it is loaded. Recall State will cause a mode switch if the state being recalled is not from the current active mode.

After the recall completes, the message "File <filename> recalled" or "Recalled State Register <register number>" is displayed.

For rapid recalls, the State menu lists 16 registers that you can choose from to recall. Pressing a Register key initiates the recall. You can also select a file from which to recall.

The default path for all State Files is:

My Documents\<mode name>\state

where <mode name> is the parameter used to select the mode with the INST:SEL command (for example, SA for the Spectrum Analyzer).

See ["More Information" on page 1005](#).

<b>Key Path</b>	Recall
<b>Mode</b>	All
<b>Remote Command</b>	:MMEMory:LOAD:STATe <filename>
<b>Example</b>	:MMEM:LOAD:STAT "myState.state" This recalls the file myState.state on the default path
<b>Example</b>	MMEM:LOAD:STAT "MyStateFile.state" This loads the state file data (on the default file directory path) into the instrument state.
<b>Notes</b>	<p>When you pick a file to recall, the analyzer first verifies that the file is recallable in the current instrument by checking the software version and model number of the instrument. If everything matches, a full recall proceeds by aborting the currently running measurement, clearing any pending operations, and then loading the State from the saved state file. You can open state files from any mode, so recalling a State file switches to the mode that was active when the save occurred. After switching to the mode of the saved state file, mode settings and data (if any for the mode) are loaded with values from the saved file. The saved measurement of the mode becomes the newly active measurement and the data relevant to the measurement (if there is any) is recalled.</p> <ul style="list-style-type: none"> <li>• If there is a mismatch between file version or model number or instrument version or model number, the recall function tries to recall as much as possible and returns a warning message. It may limit settings that differ based on model number, licensing or version number.</li> </ul> <p>After recalling the state, the Recall State function does the following:</p> <ul style="list-style-type: none"> <li>• Makes the saved measurement for the mode the active measurement.</li> <li>• Clears the input and output buffers.</li> <li>• Status Byte is set to 0.</li> </ul>



---

	<ul style="list-style-type: none"> <li>• Executes a *CLS</li> </ul> <p>If the file specified is empty an error is generated. If the specified file does not exist, another error is generated. If there is a mismatch between the file and the proper file type, an error is generated. If there is a mismatch between file version or model number or instrument version or model number, a warning is displayed. Then it returns to the State menu and File Open dialog goes away.</p> <p>After the Recall, the analyzer exits the Recall menu and returns to the previous menu.</p>
<b>Backwards Compatibility SCPI</b>	:MMEMory:LOAD:STATe 1,<filename>
Initial S/W Revision	Prior to A.02.00

---

### More Information

In measurements that support saving Traces, for example, Swept SA, the Trace data is saved along with the State in the State file. When recalling the State, the Trace data is recalled as well. Traces are recalled exactly as they were stored, including the writing mode and update and display modes. If a Trace was updating and visible when the State was saved, it will come back updating and visible, and its data will be rewritten right away. When you use State to save and recall traces, any trace whose data must be preserved should be placed in View or Blank mode before saving.

The following table describes the Trace Save and Recall possibilities:

---

You want to recall state and one trace's data, leaving other traces unaffected.	Save Trace+State from 1 trace. Make sure that no other traces are updating (they should all be in View or Blank mode) when the save is performed.	On Recall, specify the trace you want to load the one trace's data into. This trace will load in View. All other traces' data will be unaffected, although their trace mode will be as it was when the state save was performed.
You want to recall all traces	Save Trace+State from ALL traces.	On Recall, all traces will come back in View (or Blank if they were in Blank or Background when saved)
You want all traces to load exactly as they were when saved.	Save State	On recall, all traces' mode and data will be exactly as they were when saved. Any traces that were updating will have their data immediately overwritten.

---

### From File...

When you press "From File", the analyzer brings up a Windows dialog and a menu entitled "File Open." This menu allows you to navigate to the various fields in the Windows dialog without using a keyboard or mouse. The Tab and Arrow keys can also be used for dialog navigation.

## 10 Spectrum Emission Mask Measurement Recall

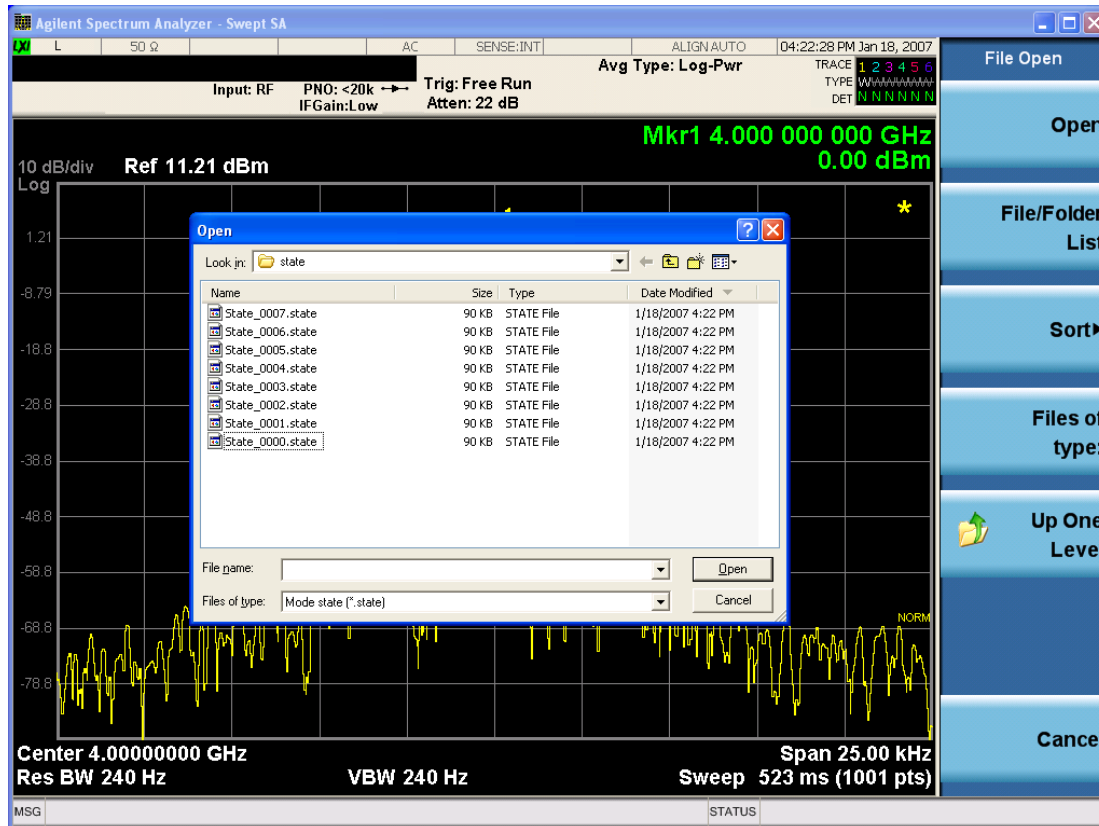

Listed below are the functions of the various fields in the dialog, and the corresponding softkeys:

### Open

Performs the recall of the specified file. While the recall is being performed, the floppy icon appears briefly in the Meas bar.

### File/Folder List

Enables you to navigate to the center of the dialog that contains the list of files and folders. Once here you can get information about the file and use the tab keys to navigate to the other fields in the dialog, such as Look In.

### Look In

The Look In field shows the path from which the file will be recalled and allows you to change the path using the up and down arrow keys to navigate to other paths; the Enter key to open a directory; and the Backspace key to go back one directory. The **Look In field** first uses the last path from the Save As dialog **Save In:** path for that same file type. There is no softkey for directly navigating to the Look In field, but you can use the left tab to get here from the File/Folder List.

User specified paths are remembered when you leave and return to a Mode and are reset back to the default using Restore Mode Defaults.

### Sort

Accesses a menu that enables you to sort the files within the File Open dialog. Only one sorting type can be selected at a time and the sorting happens immediately. The sorting types are By Date, By Name, By extension, and By Size.

#### Files of Type

This field shows the file suffix for the type of file you have selected to recall. For example, if you navigated here while recalling State, "Mode state (\*.state)" is in the field. If you navigated here while recalling Trace, ""Mode state (\*.trace)" is in the field. If you navigated here while importing a trace data file, "Trace Data (\*.csv)" is in the field. For some file types, there is more than one choice in the dropdown menu, which you can select by using the up and down arrow keys and Enter.

#### Up One Level

This key corresponds to the icon of a folder with the up arrow that is in the tool bar of the dialog. When pressed, it causes the file and folder list to navigate up one level in the directory structure. The Backspace key does the same thing.

#### Cancel

This key corresponds to the Cancel selection in the dialog. It causes the current **Open** request to be cancelled. The ESC key does the same thing.

Key Path	Recall, State
Notes	Brings up the Open dialog for recalling a State Save Type
Initial S/W Revision	Prior to A.02.00

### Edit Register Names

You may enter a custom name on any of the Register keys, to help you remember what you are using that state to save. To do this, press the Edit Register Names key, choose the register whose name you wish to edit, and then enter the desired label using the Alpha Editor or an external PC keyboard.

The maximum number of characters that can be added is 30. In most cases, 30 characters will fit on two lines of the key.

For more information and the SCPI command, see Edit Register Names under the Save, State function.

Key Path	Recall, State
Mode	All
Dependencies	N9060A-7FP or N9060B-2FP license required to edit the register names. When the feature is not licensed, sending the SCPI command generates an error, -221, "Settings conflict;Option not available"
Initial S/W Revision	A.11.00

### Register 1 thru Register 16

Selecting any one of these register keys causes the State of the mode from the specified Register to be recalled. Each of the register keys annotates whether it is empty or at what date and time it was last

modified. In addition, you can use the Edit Register Names key under Save, State to enter custom names for each register.

**NOTE** In products that run multiple instances of the X-Series Application, recalling the same register name on each instance is a way to share setups between the instances.

Registers are shared by all modes, so recalling from any one of the registers will cause a mode switch to the mode that was active when the save to the Register occurred.

Although these 16 registers are the only registers available from the front panel, there are 128 state registers available in the instrument. Registers 17–128 are only available from the SCPI interface, using the \*RCL command.

After the recall completes, the message "Register <register number> recalled" appears in the message bar. If you are in the Spectrum Analyzer Mode, and you are recalling a register that was saved in the Spectrum Analyzer Mode, then after the recall, you will still be in the Recall Register menu. If the Recall causes you to switch modes, then after the Recall, you will be in the Frequency menu.

If a requested register is empty an error is generated.

Key Path	Recall, State
Example	*RCL 1
Range	1–16 from front panel, 1–128 from SCPI
Readback	Date and time with seconds resolution are displayed on the key OR A custom name of up to 30 characters entered using the Save, State, Edit Register Names key OR “(empty)” if no prior save operation has been performed to this register.
Initial S/W Revision	Prior to A.02.00
Modified at S/W Revision	Prior to A.11.00

## Register 1 thru Register 16

Selecting any one of these register keys causes the State of the mode from the specified Register to be recalled. Each of the register keys annotates whether it is empty or at what date and time it was last modified. In addition, you can use the Edit Register Names key under Save, State to enter custom names for each register.

**NOTE** In products that run multiple instances of the X-Series Application, recalling the same register name on each instance is a way to share setups between the instances.

Registers are shared by all modes, so recalling from any one of the registers will cause a mode switch to the mode that was active when the save to the Register occurred.

Although these 16 registers are the only registers available from the front panel, there are 128 state registers available in the instrument. Registers 17–128 are only available from the SCPI interface, using the \*RCL command.

After the recall completes, the message "Register <register number> recalled" appears in the message bar. If you are in the Spectrum Analyzer Mode, and you are recalling a register that was saved in the Spectrum Analyzer Mode, then after the recall, you will still be in the Recall Register menu. If the Recall causes you to switch modes, then after the Recall, you will be in the Frequency menu.

If a requested register is empty an error is generated.

Key Path	Recall, State
<b>Example</b>	*RCL 1
Range	1-16 from front panel, 1-128 from SCPI
Readback	Date and time with seconds resolution are displayed on the key OR A custom name of up to 30 characters entered using the Save, State,Edit Register Names key OR “(empty)” if no prior save operation has been performed to this register.
Initial S/W Revision	Prior to A.02.00
Modified at S/W Revision	Prior to A.11.00

## Sequences

These keys allow you to import a Tab separated or .txt file that will automatically setup all the parameters required for building a Sequence. The parameters will automatically be loaded into the Stated Sequencer.

Once selected, in order to import the selected Sequence Type you must select the Open key in the Source Sequence menu.

Key Path	Recall, Sequences
Mode	All
<b>Remote Command</b>	:MMEMory:LOAD:SEQuences:   SLIS   ALIS   SAALIS   "MySequence.txt"
<b>Example</b>	:MMEM:LOAD:SEQ:SLIS "MySequence.txt"
Notes	Available file types are: –CSV (Comma delimited) (*.csv) –Text (Tab delimited) (*.txt)
Initial S/W Revision	A.05.00

## Source Sequence

The list of parameters, that configure steps, that makes up a sequence for the Source.

The Source sequence is a sequence of flexible configurable steps that can be set anywhere in the instruments frequency range.

Key Path	Recall,Sequences
----------	------------------

<b>Example</b>	:MMEM:LOAD:SEQ:SLIS "MySequence.txt"
<b>Dependencies</b>	Only available in XOBT
<b>Initial S/W Revision</b>	A.05.00

### Open...

When you press “Open”, the analyzer brings up a Windows dialog and a menu entitled “**File Open.**” This menu allows you to navigate to the various fields in the Windows dialog without using a keyboard or mouse. The Tab and Arrow keys can also be used for dialog navigation.

See "[From File...](#)" on page 1336 in Recall, State, for a full description of this dialog and menu.

<b>Key Path</b>	Recall, Data
<b>Notes</b>	The key location is mode-dependent and will vary. Brings up Open dialog for recalling a <mode specific> Save Type
<b>Initial S/W Revision</b>	Prior to A.02.00

### Data (Import)

Importing a data file loads data that was previously saved from the current measurement or from other measurements and/or modes that produce compatible data files. The Import Menu only contains Data Types that are supported by the current measurement.

Since the commonly exported data files are in .csv format, the data can be edited by the user prior to importing. This allows you to export a data file, manipulate the data in Excel (the most common PC Application for manipulating .csv files) and then import it.

Importing Data loads measurement data from the specified file into the specified or default destination, depending on the data type selected. Selecting an Import Data menu key will not actually cause the importing to occur, since the analyzer still needs to know from where to get the data. Pressing the Open key in this menu brings up the Open dialog and Open menu that provides you with the options from where to recall the data. Once a filename has been selected or entered in the Open menu, the recall occurs as soon as the Open button is pressed.

<b>Key Path</b>	Recall
<b>Mode</b>	All
<b>Notes</b>	The menu is built from whatever data types are available for the mode. Some keys will be missing completely, so the key locations in the sub-menu will vary. No SCPI command directly controls the Data Type that this key controls. The Data Type is included in the MMEM:LOAD commands.
<b>Dependencies</b>	If a file type is not used by a certain measurement, it is grayed out for that measurement. The key for a file type will not show at all if there are no measurements in the Mode that support it.
<b>Preset</b>	Is not affected by Preset or shutdown, but is reset during Restore Mode Defaults

Readback	The data type that is currently selected
Initial S/W Revision	Prior to A.02.00

## Mask

Enables you to recall a preset mask file. This file type (.mask) differs from a normal “state” file because it contains the configuration for Carrier, Offset, and Limit for the specific preset profile BW. A brief description of the mask file is available in the properties view of each file. (Right-mouse-click on the file, select, “Properties” to view this information.) A detailed list of the mask parameter values is located in the .pdf file of the same name in the same directory. Blank values in the .pdf file are parameters that will not be overwritten when recalling the mask.

Key Path	Recall, Data
Mode	WIMAXOFDMA
Remote Command	:MMEMory:LOAD:MASK <string>
Example	:MMEM:LOAD:MASK "MyLimitFile.mask"
Notes	Set of parameters related to Limit, Carrier and Offset are overwritten by Preset Mask file.
Initial S/W Revision	A.02.00

This topic contains the following sections:

["File location and extension" on page 1011](#)

["Example of Preset Mask file" on page 1012](#)

### File location and extension

**File location:** The preset mask file is located in “My Documents\WIMAXOFDMA\data\masks”.

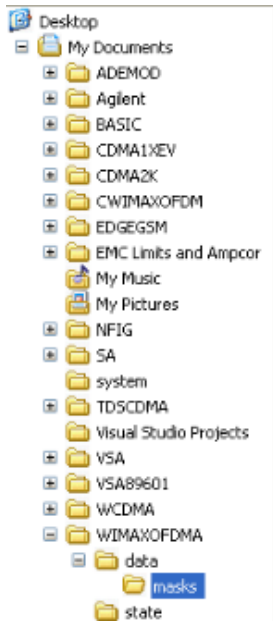

**NOTE**

When your X-Series analyzer starts, all mask files located in “My Documents\WIMAXOFDMA\data.masks” are overwritten, so any files you wish to save should be stored in another directory location.

---

**File type:** The file type is binary file.

**File Name:** The file name is decided by following naming rules. Each specific keyword is connected with underscore.

<Standard name>\_<Radio device>\_<Preset Profile BW>\_<Measurement>.mask

<Standard name>: This term references the standard associated with each mask file.

<Radio device>: This term specifies to which radio device (BS or MS) the mask file pertains.

<Preset Profile BW>: This term specifies to which Preset Profile BW the mask file pertains.

<Measurement>: This term specifies the measurement to which the mask file is applied. Your selections are: SEM, ACP, or Mode. When selecting **Mode**, the values of some parameters in both the ACP and SEM measurement are overwritten.

**File extension:** The extension of preset mask file is “mask” to distinguish it from a “state” file.

When you press the open key under the Data menu, the “My Documents\WIMAXOFDMA\data.masks” folder is opened. Select one mask file.

**NOTE**

When you change the preset BW profile or Radio Device, all measurement parameters are reset to their original values. Thus you have to recall the appropriate preset mask file again after the change.

---

### Example of Preset Mask file

When you import a preset mask file, it is a “Recall” function. Specific parameter values are overwritten by the contents of the preset mask file (see table below). Those values not specified by the preset mask file remain unchanged. Because the file format type is binary, you cannot view, change, or create the preset mask file. Here is an example of a preset mask file used for ACP measurements.



File Location: My Documents/WIMAXOFDMA/data/masks

File Name: ETSI-EN301-021-SysE\_BS\_10MHz\_ACP.mask

The .pdf file that lists the parameters similarly to that shown below is named, "ETSI-EN301-021-SysE\_BS\_10MHz\_ACP.pdf"

The set of parameters listed in the following table for the Preset Profile BW (10MHz) are imported into the ACP measurement.

Offset	Start Freq (MHz)	Stop Freq (MHz)	Sweep Time	Res BW (Hz)	Meas BW	Rel Start	Rel Stop	Fail Mask
A	5	7.14		30k	1	-8	-25	Rel
B	7.14	10.57		30k	1	-25	-27	Rel
C	10.57	20		30k	1	-27	-50	Rel
D	20	25		30k	1	-50	-50	Rel
E	25	30		30k	1	-50	-50	Rel

## Zone Map

Pressing this key selects Zone Map as the data type to be imported.

The WiMAX-OFDMA application can load the Singal Studio Setup file, and the OFDMA Map file is compatible with the 89601A Mobile WiMAX omf file.

Key Path	Recall, Data
Remote Command	:MMEMory:LOAD:ZMAP <string>
Example	MMEM:LOAD:ZMAP "ZMap_0000.omf"
Notes	The SCPI parameter is a quoted string that specifies the filename. Both single and double quotes are supported for any filename parameter over SCPI.
Dependencies	You must be in the 802.16 OFDMA (WiMAX/WiBro) mode.
Status Bits/OPC dependencies	Sequential - waits for the previous measurement to complete.
Initial S/W Revision	Prior to A.02.00

## Open...

When you press "Open", the analyzer brings up a Windows dialog and a menu entitled "File Open." This menu allows you to navigate to the various fields in the Windows dialog without using a keyboard or mouse. The Tab and Arrow keys can also be used for dialog navigation.

See "From File..." on page 1336 in Recall, State, for a full description of this dialog and menu.

10 Spectrum Emission Mask Measurement  
Recall

---

Key Path	Recall, Data
Notes	The key location is mode-dependent and will vary. Brings up Open dialog for recalling a <mode specific> Save Type
Initial S/W Revision	Prior to A.02.00

---

## Restart

The Restart function restarts the current sweep, or measurement, or set of averaged/held sweeps or measurements. If you are Paused, pressing Restart does a Resume.

The Restart function is accessed in several ways:

- Pressing the Restart key
- Sending the remote command INIT:IMMEDIATE
- Sending the remote command INIT:RESTART

See "[More Information](#)" on page 1015

Key Path	Front-panel key
Remote Command	:INITiate[:IMMEDIATE] :INITiate:RESTART
Example	:INIT:IMM :INIT:REST
Notes	:INITiate:RESTART and :INITiate:IMMEDIATE perform exactly the same function.
Couplings	Resets average/hold count k. For the first sweep overwrites all active (update=on) traces with new current data. For application modes, it resets other parameters as required by the measurement.
Status Bits/OPC dependencies	This is an Overlapped command. The STATUS:OPERation register bits 0 through 8 are cleared. The STATUS:QUESTIONable register bit 9 (INTEgrity sum) is cleared. The SWEEPING bit is set. The MEASURING bit is set.
Backwards Compatibility Notes	For Spectrum Analysis mode in ESA and PSA, the Restart hardkey and the INITiate:RESTART command restart trace averages (displayed average count reset to 1) for a trace in Clear Write, but did not restart Max Hold and Min Hold. In the X-Series, the Restart hardkey and the INITiate:RESTART command restart not only Trace Average, but MaxHold and MinHold traces as well. For wireless comms modes in ESA and PSA, the Restart hardkey and the INITiate:RESTART command restart every measurement, which includes all traces and numeric results. There is no change to this operation.
Initial S/W Revision	Prior to A.02.00

### More Information

The **Restart** function first aborts the current sweep/measurement as quickly as possible. It then resets the sweep and trigger systems, sets up the measurement and initiates a new data measurement sequence with a new data acquisition (sweep) taken once the trigger condition is met.

If the analyzer is in the process of aligning when **Restart** is executed, the alignment finishes before the restart function is performed.

Even when set for Single operation, multiple sweeps may be taken when Restart is pressed (for example, when averaging/holding is on). Thus when we say that **Restart** "restarts a measurement," we may mean:

- It restarts the current sweep
- It restarts the current measurement
- It restarts the current set of sweeps if any trace is in Trace Average, Max Hold or Min Hold
- It restarts the current set of measurements if Averaging, or Max Hold, or Min Hold is on for the measurement
- depending on the current settings.

With **Average/Hold Number** (in **Meas Setup** menu) set to 1, or Averaging off, or no trace in Trace Average or Hold, a single sweep is equivalent to a single measurement. A single sweep is taken after the trigger condition is met; and the analyzer stops sweeping once that sweep has completed. However, with **Average/Hold Number** >1 and at least one trace set to **Trace Average, Max Hold, or Min Hold (SA Measurement)** or **Averaging on (most other measurements)**, multiple sweeps/data acquisitions are taken for a single measurement. The trigger condition must be met prior to each sweep. The sweep is stopped when the average count  $k$  equals the number  $N$  set for **Average/Hold Number**. A measurement average usually applies to all traces, marker results, and numeric results; but sometimes it only applies to the numeric results.

Once the full set of sweeps has been taken, the analyzer will go to idle state. To take one more sweep without resetting the average count, increment the average count by 1, by pressing the step up key while **Average/Hold Number** is the active function, or sending the remote command CALC:AVER:TCON UP.

## Save

The Save menu lets you choose what you want to save and where you want to save it. Among the types of files you can save are **States**, **Traces**, and **Screen Images**. In addition, an Export (Data) option lets you save a number of data types as CSV files for easy import into Excel and other spreadsheet programs.

Key Path	Front-panel key
Mode	All
Notes	No remote command for this key specifically, but the :MMEM:STORe command is available for specific file types. An example is :MMEM:STOR:STATe <filename>.
Initial S/W Revision	Prior to A.02.00

## State

The Save State menu lets you choose a register or file for saving the state.

### NOTE

In products that run multiple instances of the X-Series Application, all instances share the same register and file location where you want to save the state.

The content of a state file includes all of the settings and data required to return the analyzer as closely as possible to the Mode it was in, with the exact settings which were in place, when the save occurred. The Mode settings in each state file include the settings that are affected by Mode Preset, as well as the additional settings affected by Restore Mode Defaults; all of the Mode's settings. In addition, all of the settings of the Input/Output system are included, even though they are outside of the Mode's state, because they are needed to restore the complete setup. Persistent System settings (for example, Verbose SCPI) are not affected by either Mode Preset or Restore Mode Defaults, nor are they included in a saved State file.

After the save completes, the message "File <filename> saved" or "State Register <register number> saved" is displayed.

For rapid saving, the State menu lists 16 registers to save to. Pressing a Register key initiates the save. You can also select a file to save to.

The default path for all State Files is:

My Documents\<<mode name>\state

where <mode name> is the parameter used to select the mode with the INST:SEL command (for example, SA for the Spectrum Analyzer).

Key Path	Save
Mode	All
<b>Remote Command</b>	:MMEMory:STORe:STATe <filename>
<b>Example</b>	MMEM:STOR:STATe "MyStateFile.state" This stores the current instrument state data in the file MyStateFile.state in the default directory.
Notes	Both single and double quotes are supported for any filename parameter over remote.

After saving to a register, that register's menu key is updated with the date the time, unless a custom label has been entered for that key.

After saving to a register, you remain in the Save State menu, so that you can see the Register key update. After saving to a file, the analyzer automatically returns to the previous menu and any Save As dialog goes away.

**Backwards** :MMEMory:STORE:STATE 1,<filename>

**Compatibility SCPI** For backwards compatibility, the above syntax is supported. The "1" is simply ignored. The command is sequential.

**Initial S/W Revision** Prior to A.02.00

### To File . . .

When you press “To File”, the analyzer brings up a Windows dialog and a menu entitled “Save As.” This menu allows you to navigate to the various fields in the Windows dialog without using a keyboard or mouse. The Tab and Arrow keys can also be used for dialog navigation.

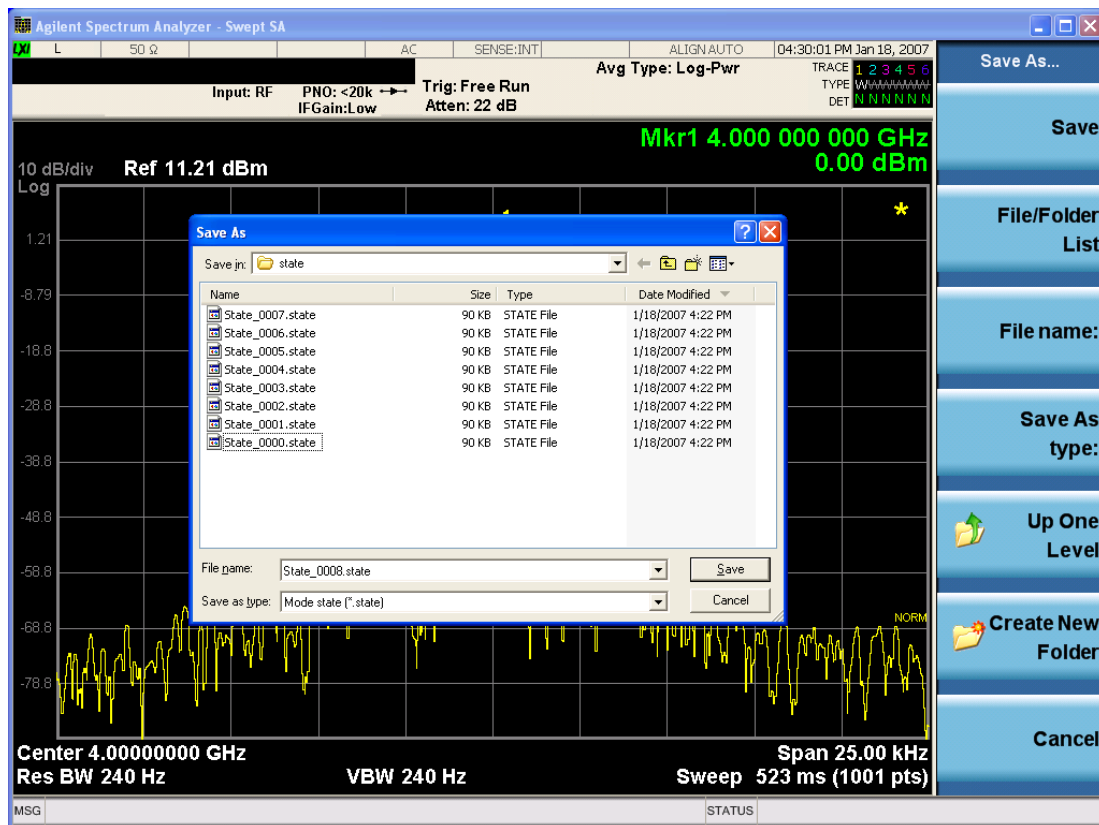

The Listed below

are the functions of the various fields in the dialog, and the corresponding softkeys:

### Save

Performs the save to the specified file of the selected type. If the file already exists, a dialog will appear that allows you to replace the existing file by selecting OK, or you can Cancel the request. If you select OK,

the file will be overwritten. Using the C: drive is strongly discouraged, since it runs the risk of being overwritten during an instrument software upgrade.

While the save is being performed, the floppy icon appears briefly in the Meas bar.

#### File/Folder List

Enables you to navigate to the center of the dialog that contains the list of files and folders. Once here you can get information about the file and use the tab keys to navigate to the other fields in the dialog, such as Save In.

#### Save In

The Save In field shows the path to which the file will be saved and allows you to change the path using the up and down arrow keys to navigate to other paths; the Enter key to open a directory; and the Backspace key to go back one directory. The **Save In field** defaults to the default path for this type of file and remembers the last path you used to save this type of file. There is no softkey for directly navigating to the Save In field but you can use left tab to get here from the File/Folder List.

User specified paths are remembered when you leave and return to a Mode and are reset back to the default using Restore Mode Defaults.

#### File Name

The File Name field is initially loaded with an automatically generated filename specific to the appropriate Save Type. The automatically generated filename is guaranteed not to conflict with any filename currently in the directory. You may replace or modify this filename using the File Name key. See the ["Quick Save " on page 1332](#) documentation for more on the automatic file naming algorithm.

When you press the File Name key the analyzer displays the Alpha Editor. Use the knob to choose the letter to add and the front-panel Enter key to add the letter to the file name. The BK character moves you back and the FW character moves you forward in the filename. The Select key on the front panel generates a space character. When you are done entering the filename press the Done softkey. This returns back to the **File Open** dialog and menu, but does not cause the save to occur.

#### Save As Type

This field shows the file suffix for the type of file you have selected to save. For example, if you navigated here while saving State, "Mode state (\*.state)" is in the field. If you navigated here from saving Trace, ""Mode state (\*.trace)" is in the field. If you navigated here while exporting a trace data file, "Trace Data (\*.csv)" is in the field. For some file types, there is more than one choice in the dropdown, which you can select by using the up and down arrow keys and Enter.

#### Up One Level

This key corresponds to the icon of a folder with the up arrow that is in the tool bar of the dialog. When pressed, it causes the file and folder list to navigate up one level in the directory structure. The Backspace key does the same thing.

#### Create New Folder

This key corresponds to the icon of a folder with the "\*" that is in the tool bar of the dialog. When pressed, a new folder is created in the current directory with the name **New Folder** and you can enter a new folder name using the Alpha Editor.

#### Cancel

This key corresponds to the Cancel selection in the dialog. It causes the current **Save As** request to be cancelled. The ESC key does the same thing.

Key Path	Save, State
Mode	All
Notes	Brings up Save As dialog for saving a State Save Type
Initial S/W Revision	Prior to A.02.00

## Edit Register Names

You may enter a custom name on any of the Register keys, to help you remember what you are using that state to save. To do this, press the Edit Register Names key, choose the register whose name you wish to edit, and then enter the desired label using the Alpha Editor or an external PC keyboard.

The maximum number of characters that can be added is 30. In most cases, 30 characters will fit on two lines of the key.

See ["More Information" on page 1020](#)

Key Path	Save, State
Mode	All
<b>Remote Command</b>	:MMEMory:REGister:STATe:LABel <reg number>,"label" :MMEMory:REGister:STATe:LABel? <reg number>
<b>Example</b>	:MMEM:REG:STAT:LAB 1,"my label"
Notes	<reg number> is an integer from 1 to 16. If the SCPI specifies an invalid register number an error message is generated, -222,"Data out of range;Invalid register label number" "label" is a string from 0 to 30 characters in length. If a label exceeds 30 characters, an error message is generated, -150,"String data error;Label clipped to 30 characters" "label" of length 0 erases the custom label and restores the default (time and date) label. E.g.: :MMEM:REG:STAT:LAB 1,""
Dependencies	N9060A-7FP or N9060B-2FP license required to edit the register names. When the feature is not licensed, sending this command generates an error, -221,"Settings conflict;Option not available"
Preset	The names are unaffected by Preset or power cycle but are set to the default label (time and date) on a "Restore System Defaults->Misc"
Initial S/W Revision	A.11.00

## More Information

When you edit one of the register names, the time and date field will be replaced by the custom name.

If you delete all the characters in the custom name, it restores the default (time and date).

The register names are stored within the state files, but they are not part of the instrument state; that is, once you have edited a register name, loading a new state will not change that register name. Another



consequence of this is that the names will be persistent through a power cycle. Also, if a named state file is transferred to another analyzer, it will bring its custom name along with it.

If you try to edit the name of an empty register, the analyzer will first save the state to have a file to put the name in. If you load a named state file into an analyzer with older firmware it will ignore the metadata.

The \*SAV and \*RCL commands will not be affected by the custom register names, nor will the MMEM commands.

### Register 1 thru Register 16

Selecting any one of these register menu keys causes the State of the currently active mode to be saved to the specified Register. The registers are provided for rapid saving and recalling, since you do not need to specify a filename or navigate to a file. Each of the register menu keys annotates whether it is empty or at what date and time it was last modified. In addition, you can use the Edit Register Names key to enter custom names for each register.

**NOTE**

In products that run multiple instances of the X-Series Application, save with different register name if you do not want to overwrite the register of another running instance.

Although these 16 registers are the only registers available from the front panel, there are 128 state registers available in the instrument. Registers 17–128 are only available from the SCPI interface, using the \*SAV command.

There is one set of 128 state registers in the instrument, not one set for each Mode. When a state is saved, the Mode it was saved from is saved with it; then when it is recalled, the instrument switches to that Mode.

After the save completes, the corresponding register menu key annotation is updated with the date and time and the message "Register <register number> saved" is displayed.

Key Path	Save, State
Mode	All
Example	*SAV 1
Range	1–16 from front panel, 1–128 from SCPI
Readback	Date and time with seconds resolution are displayed on the key OR A custom name of up to 30 characters entered using the Edit Register Names key OR “(empty)” if no prior save operation has been performed to this register.
Initial S/W Revision	Prior to A.02.00
Modified at S/W Revision	A.11.00

### Register 1 thru Register 16

Selecting any one of these register menu keys causes the State of the currently active mode to be saved to the specified Register. The registers are provided for rapid saving and recalling, since you do not need to specify a filename or navigate to a file. Each of the register menu keys annotates whether it is empty or at

what date and time it was last modified. In addition, you can use the Edit Register Names key to enter custom names for each register.

**NOTE** In products that run multiple instances of the X-Series Application, save with different register name if you do not want to overwrite the register of another running instance.

Although these 16 registers are the only registers available from the front panel, there are 128 state registers available in the instrument. Registers 17–128 are only available from the SCPI interface, using the \*SAV command.

There is one set of 128 state registers in the instrument, not one set for each Mode. When a state is saved, the Mode it was saved from is saved with it; then when it is recalled, the instrument switches to that Mode.

After the save completes, the corresponding register menu key annotation is updated with the date and time and the message "Register <register number> saved" is displayed.

Key Path	Save, State
Mode	All
<b>Example</b>	*SAV 1
Range	1–16 from front panel, 1–128 from SCPI
Readback	Date and time with seconds resolution are displayed on the key OR A custom name of up to 30 characters entered using the Edit Register Names key OR “(empty)” if no prior save operation has been performed to this register.
Initial S/W Revision	Prior to A.02.00
Modified at S/W Revision	A.11.00

### Mass Storage Catalog (Remote Command Only)

Key path	SCPI Only
<b>Remote Command</b>	:MMEMory:CATalog? [<directory_name>]
Notes	The string must be a valid logical path. Queries disk usage information (drive capacity, free space available) and obtains a list of files and directories in a specified directory in the following format: <numeric_value>,<numeric_value>,{<file_entry>} It returns two numeric parameters and as many strings as there are files and directories. The first parameter indicates the total amount of storage currently used in bytes. The second parameter indicates the total amount of storage available, also in bytes. The <file_entry> is a string. Each <file_entry> indicates the name, type, and size of one file in the directory list: <file_name>,<file_type>,<file_size> As the windows file system has an extension that indicates file type, <file_type> is always empty. <file_size> provides the size of the file in bytes. For directories, <file_entry> is surrounded by square brackets and both <file_type> and <file_size> are empty
Initial S/W Revision	Prior to A.02.00

## Mass Storage Change Directory (Remote Command Only)

Key path	SCPI Only
<b>Remote Command</b>	:MMEMory:CDIRectory [<directory_name>] :MMEMory:CDIRectory?
Notes	The string must be a valid logical path. Changes the default directory for a mass memory file system. The <directory_name> parameter is a string. If no parameter is specified, the directory is set to the *RST value. At *RST, this value is set to the default user data storage area, that is defined as System.Environment.SpecialFolder.Personal. Query returns full path of the default directory.
Initial S/W Revision	Prior to A.02.00

## Mass Storage Copy (Remote Command Only)

Key path	SCPI Only
<b>Remote Command</b>	:MMEMory:COPY <string>,<string>[,<string>,<string>]
Notes	The string must be a valid logical path. Copies an existing file to a new file or an existing directory to a new directory. Two forms of parameters are allowed. The first form has two parameters. In this form, the first parameter specifies the source, and the second parameter specifies the destination. The second form has four parameters. In this form, the first and third parameters specify the source. The second and fourth parameters specify the directories. The first pair of parameters specifies the source. The second pair specifies the destination. An error is generated if the source doesn't exist or the destination file already exists. This command will generate an "access denied" error if the destination is a restricted folder (e.g., C:\Windows) and the current user does not have Power User or Administrator privileges.

## Mass Storage Device Copy (Remote Command Only)

This command transfers data to/from a file and a peripheral device.

Key path	SCPI Only
<b>Remote Command</b>	:MMEMory:COPY:DEvice <source_string>,<dest_string>
Notes	The strings must be a valid logical path or a valid device keyword. If the dest_string is a device keyword, the data is copied from the source file to the device. If the source_string is a device keyword, the data is copied to the source file from the device. Valid device keywords are: SNS (smart noise source) An error is generated if the file or device is not found.

### Mass Storage Delete (Remote Command Only)

Key path	SCPI Only
Remote Command	:MMEMory:DELeTe <file_name>[,<directory_name>]
Notes	The string must be a valid logical path. Removes a file from the specified directory. The <file_name> parameter specifies the file name to be removed. This command will generate an "access denied" error if the file is in a restricted folder (e.g., C:\Windows) and the current user does not have Power User or Administrator privileges.
Initial S/W Revision	Prior to A.02.00

### Mass Storage Data (Remote Command Only)

Creates a file containing the specified data OR queries the data from an existing file.

Key path	SCPI Only
Remote Command	:MMEMory:DATA <file_name>, <data> :MMEMory:DATA? <file_name>
Notes	The string must be a valid logical path. The command form is MMEMory:DATA <file_name>,<data>. It loads <data> into the file <file_name>. <data> is in 488.2 block format. <file_name> is string data. The query form is MMEMory:DATA? <file_name> with the response being the associated <data> in block format.
Initial S/W Revision	Prior to A.02.00

### Mass Storage Make Directory (Remote Command Only)

Key path	SCPI Only
Remote Command	:MMEMory:MDIRectory <directory_name>
Notes	The string must be a valid logical path. Creates a new directory. The <directory_name> parameter specifies the name to be created. This command will generate an "access denied" error if the new directory would be in a restricted folder (e.g., C:\Windows) and the current user does not have Power User or Administrator privileges.
Initial S/W Revision	Prior to A.02.00

### Mass Storage Move (Remote Command Only)

Key path	SCPI Only
Remote Command	:MMEMory:MOVE <string>,<string>[,<string>,<string>]
Notes	The string must be a valid logical path. Moves an existing file to a new file or an existing directory to a new directory.

---

Two forms of parameters are allowed. The first form has two parameters. In this form, the first parameter specifies the source, and the second parameter specifies the destination.

The second form has four parameters. In this form, the first and third parameters specify the source. The second and fourth parameters specify the directories. The first pair of parameters specifies the source. The second pair specifies the destination. An error is generated if the source doesn't exist or the destination file already exists.

This command will generate an "access denied" error if the destination is a restricted folder (e.g., C:\Windows) and the current user does not have Power User or Administrator privileges.

---

Initial S/W Revision      Prior to A.02.00

---

### Mass Storage Remove Directory (Remote Command Only)

---

Key path                      SCPI Only

**Remote Command**        :MMEMory:RDIRECTory <directory\_name>

Notes                        The string must be a valid logical path.

Removes a directory. The <directory\_name> parameter specifies the directory name to be removed. All files and directories under the specified directory shall also be removed.

This command will generate an "access denied" error if the folder is a restricted folder (e.g., C:\Windows) or is in a restricted folder and the current user does not have Power User or Administrator privileges.

---

Initial S/W Revision      Prior to A.02.00

---

### Mass Storage Determine Removable Media (Remote Command Only)

This command is used to determine if any removable media devices are connected to the instrument. Primarily, these are USB memory devices plugged-in to the front panel or rear panel USB ports. On instruments with PC6 or PC7 CPU's, one SD card slot is available for removable media. The instrument's primary disk drive is not a removable media device.

---

Key Path                      SCPI Only

**Remote Command**        :MMEMory:RMEDIA:LIST?

Notes                        The return value will be a string containing a list of partition identifiers which are removable media devices. Each identifier will be separated by a comma. If no removable media is present, an empty string will be returned.

Examples:

One removable device present will result in a return string of "F:".

Two removable devices present will result in a return string of "F:,G:".

No removable devices present will result in a return string of "".

---

Initial S/W Revision      x.15.00

---

### Mass Storage Determine Removable Media Label (Remote Command Only)

This command is used to set or query a removable media device's label.

Key Path	SCPI Only
<b>Remote Command</b>	:MMEMory:RMEDia:LABel <partition>,<string> :MMEMory:RMEDia:LABel? <partition>
<b>Example</b>	MMEM:RMED:LAB "F:","My Device"
Notes	If the <partition> specified does not exist or is not a removable media device the error -252,"Missing Media" will be generated.  Setting the removable media label requires Administrative privileges. If the currently logged in user does not have appropriate privileges the error "-221.9900,Settings conflict;Administrator privileges required" is generated.
Initial S/W Revision	x.15.00

### Mass Storage Determine Removable Media Write-protect status (Remote Command Only)

This command is used to query a removable media device's write-protect status.

Key Path	SCPI Only
<b>Remote Command</b>	:MMEMory:RMEDia:WPRotect? <partition>
<b>Example</b>	MMEM:RMED:WPR? "F:"
Notes	The return value is 1 if the device is write-protected, and 0 if the device is write-enabled.  If the <partition> specified does not exist or is not a removable media device the error -252,"Missing Media" will be generated.
Preset	The return value will be depending on SD card installed.
Initial S/W Revision	x.15.00

### Mass Storage Determine Removable Media size (Remote Command Only)

This command is used to query a removable media device's total memory size (not available memory size).

Key Path	SCPI Only
<b>Remote Command</b>	:MMEMory:RMEDia:SIZE? <partition>
<b>Example</b>	MMEM:RMED:SIZE? "F:"
Notes	The return value is integer value in GBytes. Any device which is less than 1 GB will return 0 GB.  If the <partition> specified does not exist or is not a removable media device the error -252,"Missing Media" will be generated.
Initial S/W Revision	x.15.00

## Sequences

These keys allow you to save a Tab separated or CSV file of the setup parameters required to build a Sequence.

In order to save you must select the Save As button and choose a destination folder.

Key Path	Save, Sequences
Mode	All
Remote Command	:MMEM:STOR:SEquences:   SLIS   ALIS   SAALIS   SStep "MySequence.txt"
Example	:MMEM:STOR:SEQ:SLIS "MySequence.txt"
Notes	Available file types are: –CSV (Comma delimited) (*.csv) –Text (Tab delimited) (*.txt)
Initial S/W Revision	A.05.00

## Source Sequence

The list of parameters, that configure steps, that makes up a sequence for the Source.

The Source sequence is a sequence of flexible configurable steps that can be set anywhere in the instruments frequency range.

Key Path	Save, Sequences
Example	:MMEM:STOR:SEQ:SLIS "MySequence.txt"
Dependencies	Only available in XOBT
Initial S/W Revision	A.05.00

## Save As . . .

This menu lets you select the location where you can save the Sequence. This menu is a standard Windows® dialog with Save As menu keys. The "File Name" field in the Save As dialog is initially loaded with an automatically generated filename specific to the appropriate Save Type. The automatically generated filename is guaranteed not to conflict with any filename currently in the directory. You may replace or modify this filename using the File Name softkey. See the Quick Save key documentation for more on the automatic file naming algorithm.

The default path for all Sequence Files is:

My Documents\Sequences

Key Path	Save, Sequences
Mode	All

Notes	Brings up Save As dialog for saving a Sequence Save Type
Initial S/W Revision	A.05.00

## Data (Export)

Exporting a data file stores data from the current measurement to mass storage files. The Export Menu only contains data types that are supported by the current measurement.

Since the commonly exported data files are in .csv format, the data can be edited by you prior to importing. This allows you to export a data file, manipulate the data in Excel (the most common PC Application for manipulating .csv files) and then import it.

Selecting an Export Data menu key will not actually cause the exporting to occur, since the analyzer still needs to know where you wish to save the data. Pressing the Save As key in this menu brings up the Save As dialog and Save As menu that allows you to specify the destination file and directory. Once a filename has been selected or entered in the Open menu, the export will occur as soon as the Save key is pressed.

Key Path	Save
Mode	All
Notes	The menu is built from whatever data types are available for the mode. So the key locations in the sub menu will vary. No SCPI command directly controls the Data Type that this key controls. The Data Type is included in the MMEM:STOR commands.
Dependencies	If a file type is not used by a certain measurement, that type is grayed out for that measurement. The key for a file type will not show at all if there are no measurements in the Mode that support it.
Preset	Is not affected by a Preset or shutdown, but is reset during Restore Mode Defaults
Readback	The data type that is currently selected
Initial S/W Revision	Prior to A.02.00

## Measurement Results

Pressing this key selects Meas Results as the data type to be exported.

The Meas Results file contains information that describes the current state of the analyzer. It is detailed in ["Meas Results File Contents" on page 1029](#) below.

Key Path	Save, Data
Remote Command	:MMEMory:STOR:RESults <string>
Example	:MMEM:STOR:RES "MeasR_0000.csv"
Notes	If the save is initiated via SCPI and the file already exists, the file will be overwritten. The SCPI command exports Spectrum Emission Mask measurement results to the file specified as the parameter in the current path. The default path is My Documents\ current mode>\data\SEM\results.



	Using the C: drive is strongly discouraged, since it runs the risk of being overwritten during an instrument software upgrade. The SCPI parameter is a quoted string that specifies the filename. Both single and double quotes are supported for any filename parameter over SCPI.
Dependencies	The current active measurement must be the Spectrum Emission Mask measurement to use this command.
Status Bits/OPC dependencies	Sequential – waits for the previous measurement to complete
Initial S/W Revision	Prior to A.02.00

### Meas Results File Contents

A Meas Results File contains measurement results with the following information.

- File ID string, which is “MeasResult”
- Measurement ID following Mode ID, which is “SA:SEM” for example.
- Firmware rev and model number
- Option string
- Automatic Trigger Time
- Automatic Trigger Time State
- Center Frequency
- ChanIntegBW
- ChannelDetector
- ChannelDetectorState
- ChanPwrRefAuto
- ChanResBW
- ChanResBWAuto
- ChanSpan
- ChanSweepTime
- ChanSweepTimeAuto
- ChanVbwRbwRatio
- ChanVbwRbwRatioAuto
- ChanVideoBW
- ChanVideoBWAuto
- Electrical Atten

- Electrical Atten Bypass
- Electrical Atten State
- External1 Trigger Delay
- External1 Trigger Delay State
- External1 Trigger Level
- External1 Trigger Slope
- External2 Trigger Delay
- External2 Trigger Delay State
- External2 Trigger Level
- External2 Trigger Slope
- FilterAlpha
- Internal Preamp
- Internal Preamp Band
- Line Trigger Delay
- Line Trigger Delay State
- Line Trigger Slope
- Mechanical Atten
- Mechanical Atten Auto
- OffsetDetector
- OffsetDetectorState
- OffsetLimitAbsStartBTS
- OffsetLimitAbsStartMS
- OffsetLimitAbsStopBTS
- OffsetLimitAbsStopMS
- OffsetLimitFailMaskBTS
- OffsetLimitFailMaskMS
- OffsetLimitRelStartBTS
- OffsetLimitRelStartMS
- OffsetLimitRelStopBTS
- OffsetLimitRelStopMS
- OffsetMeasBWBTS

- OffsetMeasBWMS
- OffsetResolutionBWAutoBTS
- OffsetResolutionBWAutoMS
- OffsetResolutionBWBTS
- OffsetResolutionBWMS
- OffsetSideBTS
- OffsetSideMS
- OffsetStartFrequencyBTS
- OffsetStartFrequencyMS
- OffsetStateBTS
- OffsetStateMS
- OffsetStopFrequencyBTS
- OffsetStopFrequencyMS
- OffsetSweepTimeAutoBTS
- OffsetSweepTimeAutoMS
- OffsetSweepTimeBTS
- OffsetSweepTimeMS
- OffsetVbwRbwRatioAutoBTS
- OffsetVbwRbwRatioAutoMS
- OffsetVbwRbwRatioBTS
- OffsetVbwRbwRatioMS
- OffsetVideoBWAutoBTS
- OffsetVideoBWAutoMS
- OffsetVideoBWBTS
- OffsetVideoBWMS
- PeakReference
- Periodic Timer Period
- Periodic Timer Sync Source
- Periodic Timer Trigger Delay
- Periodic Timer Trigger Delay State
- PowerReference

- PSDReference
- Radio Device
- RFBurst Trigger Delay
- RFBurst Trigger Delay State
- RFBurst Trigger Level Abs
- RFBurst Trigger Level Rel
- RFBurst Trigger Level Type
- RFBurst Trigger Slope
- RrcFilter
- SemAverageNumber
- SemAverageState
- TotalAtten
- Trigger Holdoff
- Trigger Holdoff State
- TriggerSource
- Video Trigger Delay
- Video Trigger Delay State
- Video Trigger Level
- Video Trigger Slope
- ViewSelection

The file contains these data followed by MeasResult1 to MeasResult12 that flag the start of the measurement results. Each line of Measurement Results consists of twelve comma separated values from MeasResult1 value to MeasResult12 value. MeasResult1 contains the same results as MEAS/READ/FETCh:SEMAsk1; MeasResult2, MEAS/READ/FETCh:SEMAsk2; MeasResult3, MEAS/READ/FETCh:SEMAsk3;... (continues in the same manner)

The exported file is in CSV format, with a.csv extension. The Meas Results file, when imported into Excel, shows the following data:

---

MeasResult	
SA:SEM	
A.10.53	N90 30A
526 ALV ATP B1X B1Y B25 B40 BBA CR3	1

---

CRP DCF DDA		
DP2 DRD EA3		
EDP EMC EP1		
ERC ESC ESP		
EXM FSA LFE		
LNP MAT		
MPB NFE		
NUL P26 PFR		
PNC RTL RTS		
S40 SB1 SEC		
SM1 TVT YAS		
YAV		
Automatic Trigger Time	0.1	
Automatic Trigger Time State	FALS E	
Center Frequency	1.33 E+10	
ChanIntegBW	384 000 0	384 000 0
ChannelDetector	Average	
ChannelDetectorState	TRUE	
ChanPwrRefAuto	TRUE	
ChanResBW	100 000	100 000
ChanResBWAuto	FALS E	FALS E
ChanSpan	500 000 0	500 000 0
ChanSweepTime	0.00 250 7	0.00 250 7
ChanSweepTimeAuto	TRUE	TRUE
ChanVbwRbwRatio	1	1
ChanVbwRbwRatioAuto	FALS E	FALS E
ChanVideoBW	100	100

10 Spectrum Emission Mask Measurement  
Save

	000	000
ChanVideoBW Auto	TRUE	TRUE
Electrical Atten	0	
Electrical Atten Bypass	TRUE	
Electrical Atten State	FALS E	
External1 Trigger Delay	1.00 E-06	
External1 Trigger Delay State	FALS E	
External1 Trigger Level	1.2	
External1 Trigger Slope	Posit ive	
External2 Trigger Delay	1.00 E-06	
External2 Trigger Delay State	FALS E	
External2 Trigger Level	1.2	
External2 Trigger Slope	Posit ive	
FilterAlpha	0.22	
Internal Preamp	FALS E	
Internal Preamp Band	Low	
Line Trigger Delay	1.00 E-06	
Line Trigger Delay State	FALS E	
Line Trigger Slope	Posit ive	
Mechanical Atten	10	
Mechanical Atten Auto	TRUE	
OffsetDetecto	Peak	

r						
OffsetDetectorState	TRUE					
OffsetLimitAbsStartBTS	-14	-14	-26	-13	-13	-13
OffsetLimitAbsStartMS	-14	-14	-26	-13	-13	-13
OffsetLimitAbsStopBTS	-14	-26	-26	-13	-13	-13
OffsetLimitAbsStopMS	-14	-26	-26	-13	-13	-13
OffsetLimitFailMaskBTS	ABSolute	ABSolute	ABSolute	ABSolute	ABSolute	ABSolute
OffsetLimitFailMaskMS	ABSolute	ABSolute	ABSolute	ABSolute	ABSolute	ABSolute
OffsetLimitRelStartBTS	-30	-30	-30	-30	-30	-30
OffsetLimitRelStartMS	-30	-30	-30	-30	-30	-30
OffsetLimitRelStopBTS	-30	-30	-30	-30	-30	-30
OffsetLimitRelStopMS	-30	-30	-30	-30	-30	-30
OffsetMeasureBWBTS	1	1	1	1	1	1
OffsetMeasureBWMS	1	1	1	1	1	1
OffsetResolutionBWAutoBTS	FALSE	FALSE	FALSE	FALSE	FALSE	FALSE
OffsetResolutionBWAutoMS	FALSE	FALSE	FALSE	FALSE	FALSE	FALSE
OffsetResolutionBWAutoBTS	30000	30000	30000	1000000	100000	100000
OffsetResolutionBWMS	30000	30000	30000	1000000	100000	100000
OffsetSideBTS	Both	Both	Both	Both	Both	Both
OffsetSideMS	Both	Both	Both	Both	Both	Both
OffsetStartFrequencyBTS	2515000	2715000	3515000	4000000	800000	125000

OffsetStartFrequencyMS	251 500 0	271 500 0	351 500 0	4000000	800 000 0	125 000 00
OffsetStateBTS	TRUE	TRUE	TRUE	TRUE	TRUE	FALSE
OffsetStateMS	TRUE	TRUE	TRUE	TRUE	TRUE	FALSE
OffsetStopFrequencyBTS	271 500 0	351 500 0	400 000 0	8000000	125 000 00	150 000 00
OffsetStopFrequencyMS	271 500 0	351 500 0	400 000 0	8000000	125 000 00	150 000 00
OffsetSweepTimeAutoBTS	TRUE	TRUE	TRUE	TRUE	TRUE	TRUE
OffsetSweepTimeAutoMS	TRUE	TRUE	TRUE	TRUE	TRUE	TRUE
OffsetSweepTimeBTS	0.01 733 3	0.06 932	0.04 202 7	0.002053	0.00 225 3	0.00 125 3
OffsetSweepTimeMS	0.01 733 3	0.06 932	0.04 202 7	0.002053	0.00 225 3	0.00 125 3
OffsetVbwRbwRatioAutoBTS	FALSE	FALSE	FALSE	FALSE	FALSE	FALSE
OffsetVbwRbwRatioAutoMS	FALSE	FALSE	FALSE	FALSE	FALSE	FALSE
OffsetVbwRbwRatioBTS	0.01	0.01	0.01	0.01	0.01	0.01
OffsetVbwRbwRatioMS	0.01	0.01	0.01	0.01	0.01	0.01
OffsetVideoBWAutoBTS	TRUE	TRUE	TRUE	TRUE	TRUE	TRUE
OffsetVideoBWAutoMS	TRUE	TRUE	TRUE	TRUE	TRUE	TRUE
OffsetVideoBWAutoBTS	300	300	300	10000	100 00	100 00
OffsetVideoBWAutoMS	300	300	300	10000	100 00	100 00
PeakReference	- 82.9 957					



Periodic Timer Period	0.02
Periodic Timer Sync Source	None
Periodic Timer Trigger Delay	1.00 E-06
Periodic Timer Trigger Delay State	FALS E
PowerReferen ce	- 73.6 966
PSDReferenc e	- 139. 54
Radio Device	Bts
RFBurst Trigger Delay	1.00 E-06
RFBurst Trigger Delay State	FALS E
RFBurst Trigger Level Abs	-20
RFBurst Trigger Level Rel	-6
RFBurst Trigger Level Type	Absol ute
RFBurst Trigger Slope	Posit ive
RrcFilter	FALS E
SemAverageN umber	10
SemAverageS tate	FALS E
TotalAtten	10
Trigger Holdoff	0.1
Trigger	FALS

Holdoff State	E											
TriggerSource	Free											
Video Trigger Delay	1.00 E-06											
Video Trigger Delay State	FALS E											
Video Trigger Level	-25											
Video Trigger Slope	Positive											
Video Selection	AbsP wrFr eq											
MeasResult1	Meas Resul t2	Meas Resul t3	Meas Resul t4	MeasResu lt5	Meas Resul t6	Meas Resul t7	Meas Resul t8	Meas Resul t9	Meas Result 10	Meas Result 11	Meas Result 12	
-999	- 78.8 935 9	-13	999	- 73.6966 3340998 79	-999	-999	-999	-999	-999	-999	-999	
- 73.6966334 099879	- 78.9 523 5	-13	999	-999	-999	-999	-999	-999	-999	-999	-999	

## Zone Map

Pressing this key selects Zone Map as the data type to be exported.

The Zone Map file contains information about current Zone Map configuration. Its format is compatible with the 89601A OFDMA map file. It is detailed in ["Zone Map File Contents" on page 1039](#) below.

Key Path	Save, Data
Remote Command	:MMEMory:STORe:ZMAP <string>
Example	MMEM:STOR:ZMAP "ZMap_0000.omf"
Notes	<p>If the save is initiated via SCPI and the file already exists, the file will be overwritten.</p> <p>The SCPI command exports Zone Map information to the file specified as the parameter in the current path. The default path is My Documents\WIMAXOFDMA\.</p> <p>Using the C: drive is strongly discouraged, since it runs the risk of being overwritten during an instrument software upgrade.</p> <p>The SCPI parameter is a quoted string that specifies the filename. Both single and double quotes are supported for any filename parameter over SCPI.</p>
Dependencies	You must be in the 802.16 OFDMA (WiMAX/WiBro) mode.

---

Status Bits/OPC dependencies	Sequential - waits for the previous measurement to complete.
Initial S/W Revision	Prior to A.02.00

---

## Zone Map File Contents

A Zone Map File contains the following information of the Zone Map configuration. See ["Zone Map Data" on page 171](#) for detailed definitions.

- DemodOfdmaMap\_AutoDetect
- DemodOfdmaMap\_Count
- DemodOfdmaMap\_F1\_DL\_Count
- DemodOfdmaMap\_F1\_DL\_Z1\_Active
- DemodOfdmaMap\_F1\_DL\_Z1\_AmcType
- DemodOfdmaMap\_F1\_DL\_Z1\_B1\_Active
- DemodOfdmaMap\_F1\_DL\_Z1\_B1\_AllocType
- DemodOfdmaMap\_F1\_DL\_Z1\_B1\_Boost
- DemodOfdmaMap\_F1\_DL\_Z1\_B1\_BurstType
- DemodOfdmaMap\_F1\_DL\_Z1\_B1\_ColorIndex
- DemodOfdmaMap\_F1\_DL\_Z1\_B1\_ModType
- DemodOfdmaMap\_F1\_DL\_Z1\_B1\_Name
- DemodOfdmaMap\_F1\_DL\_Z1\_B1\_SubchannelInterval
- DemodOfdmaMap\_F1\_DL\_Z1\_B1\_SubchannelOffset
- DemodOfdmaMap\_F1\_DL\_Z1\_B1\_SymbolInterval
- DemodOfdmaMap\_F1\_DL\_Z1\_B1\_SymbolOffset
- DemodOfdmaMap\_F1\_DL\_Z1\_Count
- DemodOfdmaMap\_F1\_DL\_Z1\_DedicPilots
- DemodOfdmaMap\_F1\_DL\_Z1\_IDCell
- DemodOfdmaMap\_F1\_DL\_Z1\_IDCellCouple
- DemodOfdmaMap\_F1\_DL\_Z1\_Len
- DemodOfdmaMap\_F1\_DL\_Z1\_Locked
- DemodOfdmaMap\_F1\_DL\_Z1\_Name
- DemodOfdmaMap\_F1\_DL\_Z1\_PrbsID
- DemodOfdmaMap\_F1\_DL\_Z1\_StcMatrix

- DemodOfdmaMap\_F1\_DL\_Z1\_StcType
- DemodOfdmaMap\_F1\_DL\_Z1\_SymOffset
- DemodOfdmaMap\_F1\_DL\_Z1\_UseAllSC
- DemodOfdmaMap\_F1\_DL\_Z1\_WrapType
- DemodOfdmaMap\_F1\_DL\_Z1\_ZoneType
- DemodOfdmaMap\_F1\_UL\_Count
- DemodOfdmaMap\_F1\_UL\_Z1\_Active
- DemodOfdmaMap\_F1\_UL\_Z1\_AmcType
- DemodOfdmaMap\_F1\_UL\_Z1\_B1\_Active
- DemodOfdmaMap\_F1\_UL\_Z1\_B1\_AllocType
- DemodOfdmaMap\_F1\_UL\_Z1\_B1\_Boost
- DemodOfdmaMap\_F1\_UL\_Z1\_B1\_BurstType
- DemodOfdmaMap\_F1\_UL\_Z1\_B1\_ColorIndex
- DemodOfdmaMap\_F1\_UL\_Z1\_B1\_ModType
- DemodOfdmaMap\_F1\_UL\_Z1\_B1\_Name
- DemodOfdmaMap\_F1\_UL\_Z1\_B1\_PilotPattern
- DemodOfdmaMap\_F1\_UL\_Z1\_B1\_StcMode
- DemodOfdmaMap\_F1\_UL\_Z1\_B1\_SubchannelInterval
- DemodOfdmaMap\_F1\_UL\_Z1\_B1\_SubchannelOffset
- DemodOfdmaMap\_F1\_UL\_Z1\_B1\_SymbolInterval
- DemodOfdmaMap\_F1\_UL\_Z1\_B1\_SymbolOffset
- DemodOfdmaMap\_F1\_UL\_Z1\_Count
- DemodOfdmaMap\_F1\_UL\_Z1\_Gap
- DemodOfdmaMap\_F1\_UL\_Z1\_IDCell
- DemodOfdmaMap\_F1\_UL\_Z1\_Len
- DemodOfdmaMap\_F1\_UL\_Z1\_Locked
- DemodOfdmaMap\_F1\_UL\_Z1\_Name
- DemodOfdmaMap\_F1\_UL\_Z1\_SymOffset
- DemodOfdmaMap\_F1\_UL\_Z1\_UseSubchRotate
- DemodOfdmaMap\_F1\_UL\_Z1\_WrapType
- DemodOfdmaMap\_F1\_UL\_Z1\_ZoneType

- DemodOfdmaMap\_Name
- DemodOfdmaMap\_RefreshMap

### Save As . . .

When you press “Save As”, the analyzer brings up a Windows dialog and a menu entitled “**Save As.**” This menu allows you to navigate to the various fields in the Windows dialog without using a keyboard or mouse. The Tab and Arrow keys can also be used for dialog navigation.

See "[To File . . .](#)" on page 1349 in Save, State for a full description of this dialog and menu.

The default path for saving files is:

For all of the Trace Data Files:

My Documents\`<mode name>`\data\traces

For all of the Limit Data Files:

My Documents\`<mode name>`\data\limits

For all of the Measurement Results Data Files:

My Documents\`<mode name>`\data\`<measurement name>`\results

For all of the Capture Buffer Data Files:

My Documents\`<mode name>`\data\captureBuffer

Key Path	Save, Data
Mode	All
Notes	The key location is mode-dependent and will vary. Brings up the Save As dialog for saving a <code>&lt;mode specific&gt;</code> Save Type. The save is performed immediately and does not wait until the measurement is complete.
Initial S/W Revision	Prior to A.02.00

### Screen Image

Pressing Screen Image accesses a menu of functions that enable you to specify a format and location for the saved screen image. It brings up a menu that allows you to specify the color scheme of the Screen Image (Themes) or navigate to the Save As dialog to perform the actual save.

Screen Image files contain an exact representation of the analyzer display. They cannot be loaded back onto the analyzer, but they can be loaded into your PC for use in many popular applications.

The image to be saved is actually captured when the Save front panel key is pressed, and kept in temporary storage to be used if you ask for a Screen Image save. When the Screen Image key is pressed, a "thumbnail" of the captured image is displayed, as shown below:

## 10 Spectrum Emission Mask Measurement

### Save

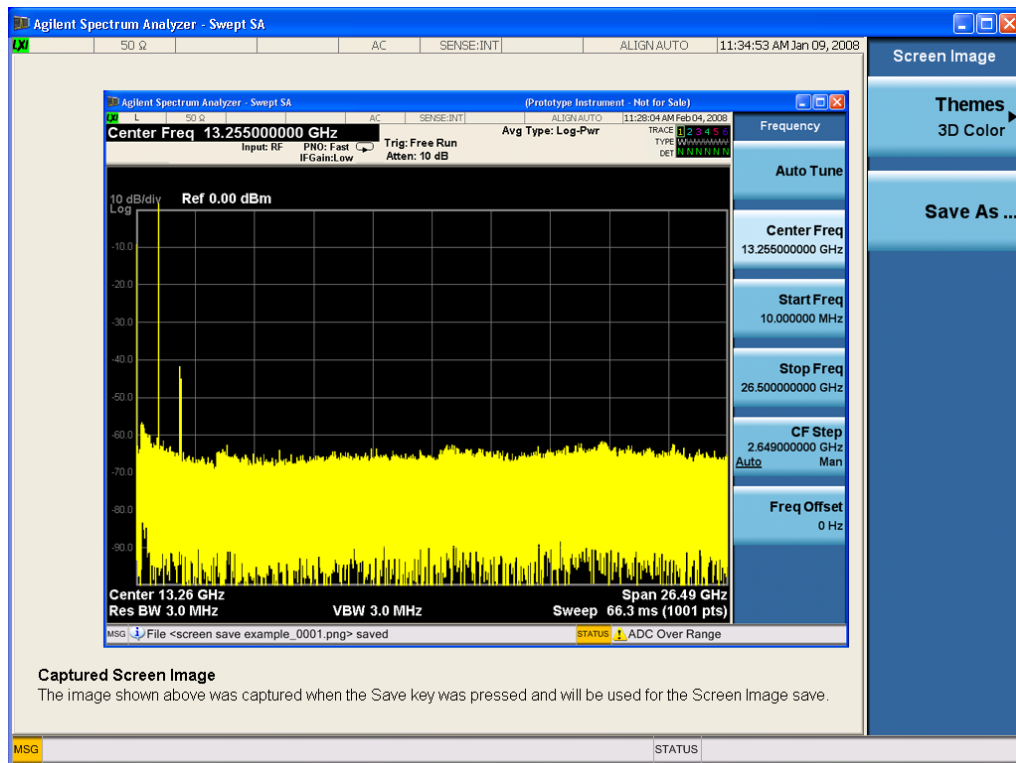

When you continue on into the Save As menu and complete the Screen Image save, the image depicted in the thumbnail is the one that gets saved, showing the menus that were on the screen before going into the Save menus. The save is performed immediately and does not wait until the measurement is complete.

After you have completed the save, the Quick Save front-panel key lets you quickly repeat the last save performed, using an auto-named file, with the current screen data.

#### NOTE

For versions previous to A.01.55, if you initiate a screen image save by navigating through the Save menus, the image that is saved will contain the Save menu softkeys, not the menus and the active function that were on the screen when you first pressed the Save front panel key.

Key Path	Save
Mode	All
Remote Command	:MMEMory:STORe:SCReem <filename>
Example	:MMEM:STOR:SCR "myScreen.png" This stores the current screen image in the file MyScreenFile.png in the default directory.
Initial S/W Revision	Prior to A.02.00

## Themes

Accesses a menu of functions that enable you to choose the theme to be used when saving the screen image.

The **Themes** option is the same as the **Themes** option under the **Display** and **Page Setup** dialogs. It allows you to choose between themes to be used when saving the screen image.

Key Path	Save, Screen Image
Remote Command	:MMEMory:STORe:SCReEn:THEMe TDColor   TDMonochrome   FCOLOR   FMONochrome  :MMEMory:STORe:SCReEn:THEMe?
Example	:MMEM:STOR:SCR:THEM TDM
Preset	3D Color; Is not part of Preset, but is reset by Restore Misc Defaults or Restore System Defaults All and survives subsequent running of the modes.
Readback	3D Color   3D Mono   Flat Color   Flat Mono
Backwards Compatibility Notes	In ESA and PSA we offer the choice of "Reverse Bitmap" or "Reverse Metafile" when saving screen images. This is much like the "Flat Color" theme available in X-Series. Also, if you selected Reverse Bitmap AND a black & white screen image, that would be much like "Flat Monochrome". In other words, each of the X-Series themes has a similar screen image type in ESA/PSA. But they are not identical.
Initial S/W Revision	Prior to A.02.00

### 3D Color

Selects a standard color theme with each object filled, shaded and colored as designed.

Key Path	Save, Screen Image, Themes
Example	MMEM:STOR:SCR:THEM TDC
Readback	3D Color
Initial S/W Revision	Prior to A.02.00

### 3D Monochrome

Selects a format that is like 3D color but shades of gray are used instead of colors.

Key Path	Save, Screen Image, Themes
Example	MMEM:STOR:SCR:THEM TDM
Readback	3D Mono
Initial S/W Revision	Prior to A.02.00

### Flat Color

Selects a format that is best when the screen is to be printed on an ink printer.

Key Path	Save, Screen Image, Themes
----------	----------------------------

<b>Example</b>	MMEM:STOR:SCR:THEM FCOL
Readback	Flat Color
Initial S/W Revision	Prior to A.02.00

### Flat Monochrome

Selects a format that is like Flat Color. But only black is used (no colors, not even gray), and no fill.

Key Path	Save, Screen Image, Themes
<b>Example</b>	MMEM:STOR:SCR:THEM FMON
Readback	Flat Mono
Initial S/W Revision	Prior to A.02.00

### Save As...

When you press "Save As", the analyzer brings up a Windows dialog and a menu entitled "**Save As.**" This menu allows you to navigate to the various fields in the Windows dialog without using a keyboard or mouse. The Tab and Arrow keys can also be used for dialog navigation.

See "[To File . . .](#)" on page 1349 in Save, State for a full description of this dialog and menu.

The default path for Screen Images is

My Documents\`<mode name>`\screen.

where `<mode name>` is the parameter used to select the mode with the INST:SEL command (for example, SA for the Spectrum Analyzer).

Key Path	Save, Screen Image
Notes	Brings up Save As dialog for saving a Screen Image Save Type
Initial S/W Revision	Prior to A.02.00



## Single (Single Measurement/Sweep)

Sets the analyzer for Single measurement operation. The single/continuous state is Meas Global, so the setting will affect all the measurements. If you are Paused, pressing Single does a Resume.

See ["More Information" on page 1045](#)

Key Path	Front-panel key
Example	:INIT:CONT OFF
Notes	See Cont key description.
Backwards Compatibility Notes	<p>For Spectrum Analysis mode in ESA and PSA, the Single hardkey and the INITiate:IMM switched from continuous measurement to single measurement and restarted sweeps and averages (displayed average count reset to 1), but did not restart Max Hold and Min Hold. In the X-Series, the Single hardkey and the INITiate:IMM command initiate a sweep/ measurement/ average sequence/hold sequence including MaxHold and MinHold.</p> <p>For Spectrum Analysis mode in ESA and PSA, the Single hardkey restarted the sweep regardless of whether or not you were in an active sweep or sweep sequence. In the X-Series, Restart does this but Single only restarts the sweep or sweep sequence if you are in the idle state.</p> <p>INIT[:IMM] in ESA &amp; PSA Spectrum Analysis Mode does an implied ABORT. In some other PSA Modes, INIT[:IMM] is ignored if not in the idle state. . The X-Series follows the ESA/PSA SA Mode model, which may cause some Modes to have compatibility problems.</p>
Initial S/W Revision	Prior to A.02.00

### More Information

See ["Restart" on page 1346](#) for details on the INIT:IMMEDIATE (Restart) function.

If you are already in single sweep, the INIT:CONT OFF command has no effect.

If you are already in Single Sweep, then pressing the Single key in the middle of a sweep does not restart the sweep or sequence. Similarly, pressing the Single key does not restart the sweep or sequence if the sweep is not in the idle state (for example, if you are taking a very slow sweep, or the analyzer is waiting for a trigger). Instead, it results in a message. "Already in Single, press Restart to initiate a new sweep or sequence". Even though pressing the Single key in the middle of a sweep does not restart the sweep, sending INIT:IMMEDIATE does reset it.

To take one more sweep without resetting the average count, increment the average count by 1, by pressing the step up key while **Average/Hold Number** is the active function, or sending the remote command CALC:AVER:TCON UP.

## Source

Opens a menu of keys that access various source configuration menus and settings. In the test set, pressing this key also causes the central view area to change and display the Source Control Main view.

Key Path	Front-panel key
----------	-----------------

## RF Output

This parameter sets the source RF power output state.

Key Path	Source
<b>Remote Command</b>	:OUTPut[:EXTErnal][:STATe] ON OFF 1 0 :OUTPut[:EXTErnal][:STATe]?
<b>Example</b>	OUTP OFF OUTP?
<b>Notes</b>	<p>The EXTErnal node is shown in RD text so the SCPI remains the same between internal and external source control. However, for EXT we do not wish to document this node to the customer since we are controlling the internal source rather than the external source.</p> <p>This setting is for the independent mode and has no effect on the <a href="#">"List Sequencer" on page 1449</a>. If the <a href="#">"Sequencer" on page 1449</a> is set to ON, the list sequencer controls the source output and this key will be grayed-out. And this setting will be none-forceful grey out on front panel to indicate out-of-scope. Non-forceful means user still can change this setting by SCPI but cannot change on front panel. When set to OFF will make source leave list sequencer and this setting will be black out and take effect immediately.</p> <p>When the RF Output is ON, an "RF" annunciator is displayed in the system settings panel. When the RF Output is turned Off, the RF annunciator is cleared. If the <a href="#">"Sequencer" on page 1449</a> is set to ON, the "RF" annunciator will be replaced by "SEQ" in the system settings panel, indicating that the output is controlled by the list sequencer.</p>
<b>Preset</b>	Off
<b>Range</b>	On   Off
<b>Initial S/W Revision</b>	A.05.00

## Amplitude

Allows you to access the Amplitude sub-menu.

Key Path	Source
<b>Notes</b>	<p>The sub-menu under this button is for independent mode and has no effect on <a href="#">"List Sequencer" on page 1449</a>. If the <a href="#">"Sequencer" on page 1449</a> is set to ON, the list sequencer controls the source output and this key will be grayed-out on front panel to indicate out-of-scope. When you set <a href="#">"Sequencer" on page 1449</a> to Off will make source leave list sequencer and this button will be black out.</p>
<b>Initial S/W Revision</b>	A.05.00

## RF Power

Allows you to adjust the power level of the source using the numeric keypad, step keys, or RPG. Pressing any digit, 0 through 9, on the numeric keypad brings up the unit terminator.

Please refer to the "RF Power Range " on page 1048 table below for the valid ranges.

Key Path	Source, Amplitude
<b>Remote Command</b>	:SOURce:POWer[:LEVel][:IMMediate][:AMPLitude] <ampl> :SOURce:POWer[:LEVel][:IMMediate][:AMPLitude]?
<b>Example</b>	:SOUR:POW -100 dBm
Notes	<p>Amplitude corrections can be specified for use with the source. In the event of amplitude corrections being applied, the valid ranges for the RF power do not change dependant on the current amplitude correction setting. If the combination of RF power + amplitude correction is higher or lower than the source output range, the Source Unleveled bit is set and the "Source Unleveled" indicator will appear on status panel to indicate that the source cannot maintain the output power that has been requested.</p> <p>When signal generator is unable to maintain the requested output level, the "Source Unleveled" indicator will appear on status panel. When the source output setting is restored to the normal range, the "Source Unleveled" is removed from status panel.</p> <p>Internal source has list sequence mode, which comprises of several steps which contain separate output power, frequency and waveform etc. When the source list sequence playing is complete, the last step keeps playing, and user can use this command to change the list sequence last step's output power.</p> <p>The multiport adapter RFIO TX ports and GPS ports cannot ensure power accuracy when power setting is lower than -130dBm, this power setting value is defined by the sum of RF Power setting and related amplitude correction value. But user settable value could be lower than this limit. When application detected there exists power setting lower than -130dBm on MPA RFIO TX ports, then popup warning message . When application detected there exists power setting lower than -130dBm on MPA GPS ports, then popup warning message . This is only warning message, and check is performed when RF is ON.</p>
Notes	The Min and Max value here defined UI settable amplitude range. This range is larger than actual amplitude range with level accuracy defined in spec.
Dependencies	The RF power is dependent on the RF output port and frequency, such that the current frequency and selected output port determine the valid range of power values.
Preset	-100 dBm
Min	The range of values depends on the current frequency and selected RF output port. Please refer to the "RF Power Range " on page 1048 table below for the valid ranges.
Max	The range of values depends on the current frequency and selected RF output port. Please refer to the "RF Power Range " on page 1048 table below for the valid ranges.
Initial S/W Revision	A.05.00

All other models:

### RF Power Range

RF Output Port	Frequency Range	Min Output Power	Max Output Power
High Power RF Out	10 MHz $\leq$ f $\leq$ 6 GHz	-150 dBm	20 dBm
RFIO 1 & RFIO 2	10 MHz $\leq$ f $\leq$ 6 GHz	-150 dBm	0 dBm
GPS (Note2)	10 MHz $\leq$ f $\leq$ 6 GHz	-150 dBm	0 dBm

Note: This is the UI power range, it's larger than actual spec.

Note2: GPS port is on the multiport adapter, or E6607C which has embedded MPA.

M9420A:

### RF Power Range

RF Output Port	Frequency Range	Min Output Power	Max Output Power without Option "1EA"	Max Output Power with Option "1EA"
RF Output	60 MHz $\leq$ f $\leq$ 6 GHz	-150 dBm	10 dBm	18 dBm
RFHD	60 MHz $\leq$ f $\leq$ 6 GHz	-150 dBm	10 dBm	15 dBm
RFFD	60 MHz $\leq$ f $\leq$ 6 GHz	-150 dBm	0 dBm	0 dBm

### Set Reference Power

This key allows you to set the power reference. Pressing this key turns the power reference state to ON, sets the reference power value to the current RF output power, maintains this power at the RF output, and sets the displayed power to 0.00 dB. All subsequent RF power values entered under Source>Amplitude>RF Power are interpreted as being relative to this reference power.

When you use a power reference, the signal generator outputs an RF power that is set relative to the reference power by the value entered under Source>Amplitude>RF Power as follows:

Output power = reference power – entered power

Where:

reference power equals the original RF Power entered under Source>Amplitude>RF Power and set as the reference power

entered power equals a new value entered under Source>Amplitude>Amptd Offset

In addition, the displayed power value is the same as a new value entered under Source>Amplitude>RF Power.

#### NOTE

If Power Ref is set to ON with a reference value set, entering a value under Source>Amplitude>RF Power and pressing Set Reference Power will add that value to the existing Power Ref value.

If you wish to change the reference power value to a new value entered under Source>Amplitude>RF Power, first you must set Power Ref to OFF and then press Set Reference Power.

Key Path	Source, Amplitude
Dependencies	This key is unavailable, and is grayed out when the <a href="#">"List Sequencer" on page 1449</a> is turned ON.
Initial S/W Revision	A.05.00

## Power Ref

This key allows you to toggle the state of the power reference.

When you use a power reference, the signal generator outputs an RF power that is set relative to the reference power by the value entered under Source>Amplitude>RF Power as follows:

Output power = reference power + entered power

Where:

reference power equals the original RF Power entered under Source>Amplitude>RF Power and set as the reference power

entered power equals a new value entered under Source>Amplitude>Amptd Offset

For more information on Reference Frequency refer to ["Set Reference Power " on page 1380](#)

Key Path	Source, Amplitude
<b>Remote Command</b>	:SOURce:POWer:REFerence <ampl> :SOURce:POWer:REFerence? :SOURce:POWer:REFerence:STATe OFF ON 0 1 :SOURce:POWer:REFerence:STATe?
<b>Example</b>	:SOUR:POW:REF 0.00 dBm :SOUR:POW:REF:STATe ON
Dependencies	This setting is unavailable and is grayed out when the <a href="#">"List Sequencer" on page 1449</a> is turned ON.
Couplings	This value is coupled to the <a href="#">"Set Reference Power " on page 1380</a> key such that pressing the Set Reference Power key updates the reference power with the current output power.
Preset	0.00 dBm OFF
Min	-125.00 dBm
Max	10.00 dBm
Initial S/W Revision	A.05.00

## Amptd Offset

Allows you to specify the RF output power offset value.

When the amplitude offset is set to zero (0) and you set a new offset value (positive or negative), the displayed amplitude value will change as follows and the RF output power will not change:

Displayed value = output power + offset value

Where:

output power equals the original RF Power entered under Source>Amplitude>RF Power

offset value equals the value entered under Source>Amplitude>Amptd Offset

When the amplitude offset is set to a value other than zero (0) and you enter a new RF power value under Source>Amplitude>RF Power, the displayed power will be the same as the value entered and the RF output power will be equal to the value entered minus the offset value as follows:

Output power = entered power – offset power

Displayed Power = output power + offset power

Displayed power = entered power

Where:

entered power equals the amplitude entered under Source>Amplitude>RF Power

offset power equals the value previously entered and set under Source>Amplitude>Amptd Offset

Key Path	Source, Amplitude
Remote Command	:SOURce:POWer[:LEVel][:IMMediate]:OFFSet <rel_ampl> :SOURce:POWer[:LEVel][:IMMediate]:OFFSet?
Example	:SOUR:POW:OFFS 0.00 dB
Dependencies	This setting is unavailable, and is grayed out when the List Sequencer is turned ON.
Preset	0.00 dB
Min	-200.00 dB
Max	200.00 dB
Initial S/W Revision	A.05.00

## Modulation

Allows you to toggle the state of the modulation.

Key Path	Source
Remote Command	:OUTPut:MODulation[:STATe] ON OFF 1 0 :OUTPut:MODulation[:STATe]?
Example	:OUTP:MOD OFF
Notes	This setting is for independent mode and has no effect on <a href="#">"List Sequencer" on page 1449</a> . If the <a href="#">"Sequencer" on page 1449</a> is set to ON, the list sequencer controls the source output and this key will be grayed-out. And this setting will be none-forceful grey out on front panel to indicate out-of-scope. Non-forceful means user still can change this setting by SCPI but cannot change manually on front panel. When set to Off will make source leave list sequencer and this setting will be black out and take effect immediately. When the Modulation is ON, the "MOD" annunciator is displayed in the system settings panel. When the Modulation is turned Off, the "MOD" annunciator is cleared. If the

"Sequencer" on page 1449 is set to ON, the "MOD" annunciator will be replaced by "SEQ" in the system settings panel indicating that the output is controlled by list sequencer.

Preset	Off
Range	On   Off
Initial S/W Revision	A.05.00

## Frequency

Allows you to access the Frequency sub-menu.

Key Path	Source
Notes	The sub-menu under this button is for independent mode and has no effect on "List Sequencer" on page 1449. If the "Sequencer" on page 1449 is set to ON, the list sequencer controls the source output and this key will be grayed-out. And this button will be grey out on front panel to indicate out-of-scope. When set to Off will make source leave list sequencer and this button will be black out.
Initial S/W Revision	A.05.00

## Frequency

Allows you to set the RF Output Frequency. You can adjust the frequency of the source using the numeric keypad, step keys, or RPG. Pressing any digit, 0 through 9, on the numeric keypad brings up the unit terminator.

Key Path	Source, Frequency
<b>Remote Command</b>	:SOURce:FREQuency[:CW] <freq> :SOURce:FREQuency[:CW]?
<b>Example</b>	:SOUR:FREQ 1.00 GHz
Notes	Internal source has list sequence mode, which comprises of several steps which contain separate output power, frequency and waveform etc. When the source list sequence playing is complete, the last step keeps playing, and user can use this command to change the list sequence last step's output frequency.
Couplings	The frequency value is coupled to the current channel band and number, such that updates to the band and number will update the frequency value to the corresponding absolute frequency.
Preset	1.00 GHz If license F1A or 5WC is present, the default Center Frequency should be 2.412GHz.
Min	10.00 MHz
Max	Hardware Dependant: Option 503 = 3.6 GHz Option 504 = 3.8 GHz Option 506 = 6.00 GHz For E6640A, if license 5WC is present, the frequency range should be limited to: 1.1GHz-1.7GHz,

2.4GHz–2.5GHz, 4.8GHz–6.0GHz. If the user-defined frequency is outside of range, UI will report an error message called “Settings conflict; Frequency is outside available range”.

Initial S/W Revision      A.05.00

## Channel

The frequency of the source can be specified by a channel number of a given frequency band. This key allows you to specify the current channel number. For the appropriate range of channel numbers for a given frequency band, refer to the following tables: ["GSM/EDGE Channel Number Ranges" on page 1052](#), ["W-CDMA Channel Number Ranges" on page 1053](#), ["CDMA 2000 / 1xEVDO Channel Number Ranges" on page 1055](#), and ["LTE FDD Channel Number Ranges" on page 1057](#).

Key Path	Source, Frequency
<b>Remote Command</b>	:SOURce:FREQuency:CHANnels:NUMBer <int> :SOURce:FREQuency:CHANnels:NUMBer?
<b>Example</b>	:SOUR:FREQ:CHAN:NUMB 1
Notes	This key is grayed out when the <a href="#">"Radio Standard" on page 1392</a> is set to NONE. This key is grayed out on E6630A.
Dependencies	This key is grayed out when the <a href="#">"Radio Standard" on page 1392</a> is set to NONE. This key is grayed out on E6630A.
Couplings	The channel number is coupled to the frequency value when the <a href="#">"Radio Standard" on page 1392</a> is not set to NONE. When the frequency value is changed, the channel number will increase or decrease to match the new frequency. If the frequency is not at an exact match for a channel number, the nearest channel number is displayed along with a greater than or less than sign to indicate the frequency is above or below the channel number.
Preset	1
Min	Please refer to the tables below for the valid ranges.
Max	Please refer to the tables below for the valid ranges.
Initial S/W Revision	A.05.00

## GSM/EDGE Channel Number Ranges

Band	Link (Device)	Range	Frequency (MHz)
P-GSM	Uplink (MS)	$1 \leq n \leq 124$	$890.0 + 0.2*n$
	Downlink (BS)	$1 \leq n \leq 124$	$935.0 + 0.2*n$
E-GSM	Uplink (MS)	$0 \leq n \leq 124$	$890.0 + 0.2*n$
		$975 \leq n \leq 1023$	$890.0 + 0.2*(n-1024)$
	Downlink (BS)	$0 \leq n \leq 124$	$935.0 + 0.2*n$
		$975 \leq n \leq 1023$	$935.0 + 0.2*(n-1024)$



Band	Link (Device)	Range	Frequency (MHz)
DCS 1800	Uplink (MS)	$512 \leq n \leq 885$	$1710.200 + 0.20*(n-512)$
	Downlink (BS)	$512 \leq n \leq 885$	$1805.200 + 0.20*(n-512)$
PCS 1900	Uplink (MS)	$512 \leq n \leq 810$	$1850.200 + 0.2*(n-512)$
	Downlink (BS)	$512 \leq n \leq 810$	$1930.200 + 0.2*(n-512)$
R-GSM	Uplink (MS)	$0 \leq n \leq 124$	$890.0 + 0.2*n$
		$955 \leq n \leq 1023$	$890.0 + 0.2*(n-1024)$
	Downlink (BS)	$0 \leq n \leq 124$	$935.0 + 0.2*n$
		$955 \leq n \leq 1023$	$935.0 + 0.2*(n-1024)$
GSM 450	Uplink (MS)	$256 \leq n \leq 293$	$450.6 + 0.2*(n-259)$
	Downlink (BS)	$256 \leq n \leq 293$	$460.6 + 0.2*(n-259)$
GSM 480	Uplink (MS)	$306 \leq n \leq 340$	$479.000 + 0.20*(n-306)$
	Downlink (BS)	$306 \leq n \leq 340$	$489.000 + 0.20*(n-306)$
GSM 850	Uplink (MS)	$128 \leq n \leq 251$	$824.200 + 0.20*(n-128)$
	Downlink (BS)	$128 \leq n \leq 251$	$869.200 + 0.20*(n-128)$
GSM 700	Uplink (MS)	$438 \leq n \leq 516$	$777.200 + 0.20*(n-438)$
	Downlink (BS)	$438 \leq n \leq 516$	$747.200 + 0.20*(n-438)$
T-GSM810	Uplink (MS)	$350 \leq n \leq 425$	$806.0 + 0.20*(n-350)$
	Downlink (BS)	$350 \leq n \leq 425$	$851.0 + 0.20*(n-350)$

### W-CDMA Channel Number Ranges

Band	Link (Device)	Range	Frequency (MHz)
Band I	Downlink	$10562 \leq n \leq 10838$	$n \div 5$
	Uplink	$9612 \leq n \leq 9888$	$n \div 5$
Band II	Downlink	$412 \leq n \leq 687$	$n \div 5 + 1850.1$
		$9662 \leq n \leq 9938$	$n \div 5$
	Uplink	$12 \leq n \leq 287$	$n \div 5 + 1850.1$
		$350 \leq n \leq 425$	$n \div 5$
Band III	Downlink	$1162 \leq n \leq 1513$	$n \div 5 + 1575$
	Uplink	$937 \leq n \leq 1288$	$n \div 5 + 1525$
Band IV	Downlink	$537 \leq n \leq 1738$	$n \div 5 + 1805$
		$1887 \leq n \leq 2087$	$n \div 5 + 1735.1$
	Uplink	$1312 \leq n \leq 1513$	$n \div 5 + 1450$
		$1662 \leq n \leq 1862$	$n \div 5 + 1380.1$
Band V	Downlink	$1007 \leq n \leq 1087$	$n \div 5 + 670.1$
		$4357 \leq n \leq 4458$	$n \div 5$

Band	Link (Device)	Range	Frequency (MHz)
	Uplink	$782 \leq n \leq 862$	$n \div 5 + 670.1$
		$4132 \leq n \leq 4233$	$n \div 5$
Band VI	Downlink	$1037 \leq n \leq 1062$	$n \div 5 + 670.1$
		$4387 \leq n \leq 4413$	$n \div 5$
	Uplink	$812 \leq n \leq 837$	$n \div 5 + 670.1$
		$4162 \leq n \leq 4188$	$n \div 5$
Band VII	Downlink	$2237 \leq n \leq 2563$	$n \div 5 + 2175$
		$2587 \leq n \leq 2912$	$n \div 5 + 2105.1$
	Uplink	$2012 \leq n \leq 2338$	$n \div 5 + 2100$
		$2362 \leq n \leq 2687$	$n \div 5 + 2030.1$
Band VIII	Downlink	$2937 \leq n \leq 3088$	$n \div 5 + 340$
	Uplink	$2712 \leq n \leq 2863$	$n \div 5 + 340$
Band IX	Downlink	$9237 \leq n \leq 9387$	$n \div 5$
	Uplink	$8762 \leq n \leq 8912$	$n \div 5$
Band X	Downlink	$3112 \leq n \leq 3388$	$n \div 5 + 1490$
		$3412 \leq n \leq 3687$	$n \div 5 + 1430.1$
	Uplink	$2887 \leq n \leq 3163$	$n \div 5 + 1135$
		$3187 \leq n \leq 3462$	$n \div 5 + 1075.1$
Band XI	Downlink	$3712 \leq n \leq 3812$	$n \div 5 + 736$
	Uplink	$3487 \leq n \leq 3587$	$n \div 5 + 733$
Band XII	Downlink	$3837 \leq n \leq 3903$	$n \div 5 - 37$
		$3927 \leq n \leq 3992$	$n \div 5 - 54.9$
	Uplink	$3612 \leq n \leq 3678$	$n \div 5 - 22$
		$3702 \leq n \leq 3767$	$n \div 5 - 39.9$
Band XIII	Downlink	$4017 \leq n \leq 4043$	$n \div 5 - 55$
		$4067 \leq n \leq 4092$	$n \div 5 - 64.9$
	Uplink	$3792 \leq n \leq 3818$	$n \div 5 + 21$
		$3702 \leq n \leq 3767$	$n \div 5 - 39.9$
Band XIV	Downlink	$4117 \leq n \leq 4143$	$n \div 5 - 63$
		$4167 \leq n \leq 4192$	$n \div 5 - 72.9$
	Uplink	$3892 \leq n \leq 3918$	$n \div 5 + 12$
		$3942 \leq n \leq 3967$	$n \div 5 + 2.1$
Band XIX	Downlink	$712 \leq n \leq 763$	$n \div 5 + 735$
		$787 \leq n \leq 837$	$n \div 5 + 720.1$
	Uplink	$312 \leq n \leq 363$	$n \div 5 + 770$
		$387 \leq n \leq 437$	$n \div 5 + 755.1$

CDMA 2000 / 1xEVDO Channel Number Ranges

Band	Link (Device)	Range	Frequency (MHz)
US Cellular	Uplink (MS, reverse link)	$1 \leq N \leq 799$	$0.030 \times N + 825.000$
		$991 \leq N \leq 1023$	$0.030 \times (N - 1023) + 825.000$
		$1024 \leq N \leq 1323$	$0.030 \times (N - 1024) + 815.040$
	Downlink (BS, forward link)	$1 \leq N \leq 799$	$0.030 \times N + 870.000$
		$991 \leq N \leq 1023$	$0.030 \times (N - 1023) + 870.000$
		$1024 \leq N \leq 1323$	$0.030 \times (N - 1024) + 860.040$
US PCS	Uplink (MS, reverse link)	$0 \leq N \leq 1199$	$1850.000 + 0.050 \times N$
	Downlink (BS, forward link)	$0 \leq N \leq 1199$	$1930.000 + 0.050 \times N$
Japan Cellular Band	Uplink (MS, reverse link)	$1 \leq N \leq 799$	$0.0125 \times (N + 915.000)$
		$801 \leq N \leq 1039$	$0.0125 \times (N - 800) + 898.000$
		$1041 \leq N \leq 1199$	$0.0125 \times (N - 1040) + 887.000$
		$1201 \leq N \leq 1600$	$0.0125 \times (N - 1200) + 893.000$
	Downlink (BS, forward link)	$1 \leq N \leq 799$	$0.0125 \times (N + 860.000)$
		$801 \leq N \leq 1039$	$0.0125 \times (N - 800) + 843.000$
		$1041 \leq N \leq 1199$	$0.0125 \times (N - 1040) + 832.000$
		$1201 \leq N \leq 1600$	$0.0125 \times (N - 1200) + 838.000$
Korean PCS Band	Uplink (MS, reverse link)	$0 \leq N \leq 599$	$0.050 \times N + 1750.000$
	Downlink (BS, forward link)	$0 \leq N \leq 599$	$0.050 \times N + 1840.000$
NMT-450 Band	Uplink (MS, reverse link)	$1 \leq N \leq 400$	$0.025 \times (N - 1) + 450.000$
		$472 \leq N \leq 871$	$0.025 \times (N - 472) + 410.000$
		$1039 \leq N \leq 1473$	$0.020 \times (N - 1024) + 451.010$
		$1536 \leq N \leq 1715$	$0.025 \times (N - 1536) + 479.000$
		$1792 \leq N \leq 2016$	$0.020 \times (N - 1792) + 479.000$
	Downlink (BS, forward link)	$1 \leq N \leq 400$	$0.025 \times (N - 1) + 460.000$
		$472 \leq N \leq 871$	$0.025 \times (N - 472) + 420.000$
		$1039 \leq N \leq 1473$	$0.020 \times (N - 1024) + 461.010$
IMT-2000 Band	Uplink (MS, reverse link)	$0 \leq N \leq 1199$	$1920.000 + 0.050 \times N$
	Downlink (BS, forward link)	$0 \leq N \leq 1199$	$2100.000 + 0.050 \times N$
Upper 700 MHz Band	Uplink (MS, reverse link)	$0 \leq N \leq 240$	$776.000 + 0.050 \times N$
	Downlink (BS, forward link)	$0 \leq N \leq 240$	$746.000 + 0.050 \times N$

Band	Link (Device)	Range	Frequency (MHz)
	forward link)		
Secondary 800 MHz Band	Uplink (MS, reverse link)	$0 \leq N \leq 719$	$0.025 \times N + 806.000$
		$720 \leq N \leq 919$	$0.025 \times (N - 720) + 896.000$
	Downlink (BS, forward link)	$0 \leq N \leq 719$	$0.025 \times N + 851.000$
		$720 \leq N \leq 919$	$0.025 \times (N - 720) + 935.000$
2.5 GHz IMT Extension	Uplink (MS, reverse link)	$0 \leq N \leq 1399$	$2500.000 + 0.050 \times N$
	Downlink (BS, forward link)	$0 \leq N \leq 1399$	$2620.000 + 0.050 \times N$
US PCS 1.9 GHz	Uplink (MS, reverse link)	$0 \leq N \leq 1299$	$1850.000 + 0.050 \times N$
	Downlink (BS, forward link)	$0 \leq N \leq 1299$	$1930.000 + 0.050 \times N$
AWS	Uplink (MS, reverse link)	$0 \leq N \leq 899$	$1710.000 + 0.050 \times N$
	Downlink (BS, forward link)	$0 \leq N \leq 899$	$2100.000 + 0.050 \times N$
US 2.5 GHz	Uplink (MS, reverse link)	$140 \leq N \leq 1459$	$2495.000 + 0.050 \times N$
	Downlink (BS, forward link)	$140 \leq N \leq 1459$	$2617.000 + 0.050 \times N$
700 Public Safety	Uplink (MS, reverse link)	$0 \leq N \leq 240$	$787.000 + 0.050 \times N$
	Downlink (BS, forward link)	$0 \leq N \leq 240$	$757.000 + 0.050 \times N$
C2K Lower 700	Uplink (MS, reverse link)	$0 \leq N \leq 360$	$698.000 + 0.050 \times N$
	Downlink (BS, forward link)	$0 \leq N \leq 360$	$728.000 + 0.050 \times N$
400 Euro PAMR	Uplink (MS, reverse link)	$1 \leq N \leq 400$	$0.025 \times (N - 1) + 450.000$
		$472 \leq N \leq 871$	$0.025 \times (N - 472) + 410.000$
	Uplink (MS, reverse link)	$1536 \leq N \leq 1715$	$0.025 \times (N - 1536) + 479.000$
	Uplink (MS, reverse link)		
	Downlink (BS, forward link)	$1 \leq N \leq 400$	$0.025 \times (N - 1) + 460.000$
		$472 \leq N \leq 871$	$0.025 \times (N - 472) + 420.000$
	Downlink (BS, forward link)	$1536 \leq N \leq 1715$	$0.025 \times (N - 1536) + 489.000$

Band	Link (Device)	Range	Frequency (MHz)
800 PAMR	Uplink (MS, reverse link)	$0 \leq N \leq 239$	$870.0125 + 0.025 \times N$
	Downlink (BS, forward link)	$0 \leq N \leq 239$	$915.0125 + 0.025 \times N$

### LTE FDD Channel Number Ranges

The carrier frequency in the uplink and downlink is designated by the E-UTRA Absolute Radio Frequency Channel Number (EARFCN) in the range 0 – 65535. The relation between EARFCN and the carrier frequency in MHz for the downlink is given by the following equation, where FDL\_low and NOffs-DL are given in table 5.4.4-1 and NDL is the downlink EARFCN.

$$FDL = FDL\_low + 0.1(NDL - NOffs-DL)$$

The relation between EARFCN and the carrier frequency in MHz for the uplink is given by the following equation where FUL\_low and NOffs-UL are given in table 5.4.4-1 and NUL is the uplink EARFCN.

$$FUL = FUL\_low + 0.1(NUL - NOffs-UL)$$

Band	Downlink		Uplink			
	FDL_low (MHz)	NOffs-DL	Range of NDL	FUL_low (MHz)	NOffs-UL	Range of NUL
1		2110	0	0 - 599	1920	18000 - 18599
2		1930	600	600 - 1199	1850	18600 - 19199
3		1805	1200	1200 - 1949	1710	19200 - 19949
4		2110	1950	1950 - 2399	1710	19950 - 20399
5		869	2400	2400 - 2649	824	20400 - 20649
6		875	2650	2650 - 2749	830	20650 - 20749
7		2620	2750	2750 - 3449	2500	20750 - 20449
8		925	3450	3450 - 3799	880	21450 - 21799
9		1844.9	3800	3800 - 4149	1749.9	21800 - 22149
10		2110	4150	4150 - 4749	1710	22150 - 22749
11		1475.9	4750	4750 - 4949	1427.9	22750 - 22949

Band	Downlink	Uplink				
12	729	5010	5010 - 5179	699	23010	23010 - 23179
13	746	5180	5180 - 5279	777	23180	23180 - 23279
14	758	5280	5280 - 5379	788	23280	23280 - 23379
...						
17	734	5730	5730 - 5849	704	23730	23730 - 23849
18	860	5850	5850 - 5999	815	23850	23850 - 23999
19	875	6000	6000 - 6149	830	24000	24000 - 24149
20	791	6150	6150 - 6449	832	24150	24150 - 24449
21	1495.9	6450	6450 - 6599	1447.9	24450	24450 - 24599
...						
24	1525	7700	7700 - 8039	1626.5	25700	25700 - 26039
25	1930	8040	8040 - 8689	1850	26040	26040 - 26689
26	859	8690	8690 - 9039	814	26690	26690 - 27039
...						

Note: The channel numbers that designate carrier frequencies so close to the operating band edges that the carrier extends beyond the operating band edge shall not be used. This implies that the first 7, 15, 25, 50, 75 and 100 channel numbers at the lower operating band edge and the last 6, 14, 24, 49, 74 and 99 channel numbers at the upper operating band edge shall not be used for channel bandwidths of 1.4, 3, 5, 10, 15 and 20 MHz respectively.

### LTE TDD Channel Number Ranges

The carrier frequency in the uplink and downlink is designated by the E-UTRA Absolute Radio Frequency Channel Number (EARFCN) in the range 0 – 65535. The relation between EARFCN and the carrier frequency in MHz for the downlink is given by the following equation, where FDL\_low and NOffs-DL are given in table 5.4.4-1 and NDL is the downlink EARFCN.

$$FDL = FDL\_low + 0.1(NDL - NOffs-DL)$$

The relation between EARFCN and the carrier frequency in MHz for the uplink is given by the following equation where FUL\_low and NOffs-UL are given in table 5.4.4-1 and NUL is the uplink EARFCN.

$$FUL = FUL\_low + 0.1(NUL - NOffs-UL)$$

Band	Downlink		Uplink		
	NOffs-DL	Range of ND	FUL_low (MHz)	NOffs-UL	Range of NUL
33	1900	36000	36000 - 36199	1900	36000 - 36199
34	2010	36200	36200 - 36349	2010	36200 - 36349
35	1850	36350	36350 - 36949	1850	36350 - 36949
36	1930	36950	36950 - 37549	1930	36950 - 37549
37	1910	37550	37550 - 37749	1910	37550 - 37749
38	2570	37750	37750 - 38249	2570	37750 - 38249
39	1880	38250	38250 - 38649	1880	38250 - 38649
40	2300	38650	38650 - 39649	2300	38650 - 39649
41	2496	39650	39650 - 41589	2496	39650 - 41589
42	3400	41590	41590 - 43589	3400	41590 - 43589
43	3600	43590	43590 - 45589	3600	43590 - 45589

Note: The channel numbers that designate carrier frequencies so close to the operating band edges that the carrier extends beyond the operating band edge shall not be used. This implies that the first 7, 15, 25, 50, 75 and 100 channel numbers at the lower operating band edge and the last 6, 14, 24, 49, 74 and 99 channel numbers at the upper operating band edge shall not be used for channel bandwidths of 1.4, 3, 5, 10, 15 and 20 MHz respectively.

## TDSCDMA Channel Number Ranges

### 1.28 Mcps TDD Option

No TX-RX frequency separation is required as Time Division Duplex (TDD) is employed. Each subframe consists of 7 main timeslots where all main timeslots (at least the first one) before the single switching point are allocated DL and all main timeslots (at least the last one) after the single switching point are allocated UL.

The nominal channel spacing is 1.6 MHz, but this can be adjusted to optimise performance in a particular deployment scenario.

The carrier frequency is designated by the UTRA absolute radio frequency channel number (UARFCN). The value of the UARFCN in the IMT2000 band is defined in the general case as follows:

$$N_t = 5 * F \text{ 0.0 MHz } \leq F \leq 3276.6 \text{ MHz}$$

where F is the carrier frequency in MHz

Additional channels applicable to operation in the frequency band defined in sub-clause 5.2(d) are defined via the following UARFCN definition:

$$N_t = 5 * (F - 2150.1 \text{ MHz}) / 2572.5 \text{ MHz} \leq F \leq 2617.5 \text{ MHz}$$

UARFCN

1.28 Mcps TDD Option

The following UARFCN range shall be supported for each band:

**Table: UTRA Absolute Radio Frequency Channel Number 1.28 Mcps TDD Option**

Frequency Band	Frequency Range	UARFCN Uplink and Downlink transmission
For operation in frequency band as defined in subclause 5.2 (a)	1900-1920 MHz	9504 to 9596
	2010-2025 MHz	10054 to 10121
For operation in frequency band as defined in subclause 5.2 (b)	1850-1910 MHz	9254 to 9546
	1930-1990 MHz	9654 to 9946
For operation in frequency band as defined in subclause 5.2 (c)	1910-1930 MHz	9554 to 9646
For operation in frequency band as defined in subclause 5.2 (d)	2570-2620 MHz	12854 to 13096
For operation in frequency band as defined in subclause 5.2 (e)	2300-2400 MHz	11504 to 11996
For operation in frequency band as defined in subclause 5.2 (f)	1880-1920 MHz	9404 to 9596

## Radio Setup

Allows access to the sub-menus for selecting the radio standard and associated radio band. You can also set a frequency reference and offset.

This menu is greyed out when on E6630A. Radio band settings for GSM, cdma2000, and so on -- most of which are not actually supported in E6630A, which has three narrow frequency bands. So band settings are grayed out.

Key Path	Source, Frequency
Initial S/W Revision	A.05.00

## Radio Standard

Allows access to the channel band sub-menus to select the desired radio standard. When you have selected the radio standard, you can then set an active channel band. The radio standard and the active



channel band allow you to use channel numbers to set frequency automatically.

Key Path	Source, Frequency, Radio Setup
<b>Remote Command</b>	:SOURce:FREQuency:CHANnels:BAND NONE   PGSM   EGSM   RGSM   DCS1800   PCS1900   TGSM810   GSM450   GSM480   GSM700   GSM850   BANDI   BANDII   BANDIII   BANDIV   BANDV   BANDVI   BANDVII   BANDVIII   BANDIX   BANDX   BANDXI   BANDXII   BANDXIII   BANDXIV   BANDXIX   USCELL   USPCS   JAPAN   KOREAN   NMT   IMT2K   UPPER   SECOND   PAMR400   PAMR800   IMTEXT   PCS1DOT9G   AWS   US2DOT5G   PUBLIC   LOWER   BAND1   BAND2   BAND3   BAND4   BAND5   BAND6   BAND7   BAND8   BAND10   BAND11   BAND12   BAND13   BAND14   BAND17   BAND18   BAND19   BAND20   BAND21   BAND24   BAND25   BAND26   BAND27   BAND28   BAND29   BAND30   BAND31   BAND33   BAND34   BAND35   BAND36   BAND37   BAND38   BAND39   BAND40   BAND41   BAND42   BAND43   BAND44   BANDA   BANDB   BANDC   BANDD   BANDE   BANDF  :SOURce:FREQuency:CHANnels:BAND?
<b>Example</b>	:SOUR:FREQ:CHAN:BAND PGSM
<b>Notes</b>	Set this setting to "NONE" will grey out "Channel" on page 1384 Channel
Initial S/W Revision	A.05.00

#### None

Selects no radio standard for use. When you have selected the radio standard to NONE, you cannot use channel numbers to set frequency automatically. You will need to set the frequency manually.

Key Path	Source, Frequency, Radio Setup, Radio Standard
Initial S/W Revision	A.05.00

#### GSM/EDGE

Sets GSM/EDGE as the radio standard for use and accesses the GSM/EDGE specific channel band sub-menus.

Key Path	Source, Frequency, Radio Setup, Radio Standard
Initial S/W Revision	A.05.00

#### P-GSM

Selects P-GSM as the active channel band.

Key Path	Source, Frequency, Radio Setup, Radio Standard, GSM/EDGE
<b>Example</b>	:SOUR:FREQ:CHAN:BAND PGSM
Initial S/W Revision	A.05.00

### E-GSM

Selects E-GSM as the active channel band.

Key Path	Source, Frequency, Radio Setup, Radio Standard, GSM/EDGE
<b>Example</b>	:SOUR:FREQ:CHAN:BAND EGSM
Initial S/W Revision	A.05.00

### R-GSM

Selects R-GSM as the active channel band.

Key Path	Source, Frequency, Radio Setup, Radio Standard, GSM/EDGE
<b>Example</b>	:SOUR:FREQ:CHAN:BAND RGSM
Initial S/W Revision	A.05.00

### DCS 1800

Selects DCS 1800 as the active channel band.

Key Path	Source, Frequency, Radio Setup, Radio Standard, GSM/EDGE
<b>Example</b>	:SOUR:FREQ:CHAN:BAND DCS1800
Initial S/W Revision	A.05.00

### PCS 1900

Selects PCS 1900 as the active channel band.

Key Path	Source, Frequency, Radio Setup, Radio Standard, GSM/EDGE
<b>Example</b>	:SOUR:FREQ:CHAN:BAND PCS1900
Initial S/W Revision	A.05.00

### GSM 450

Selects GSM 450 as the active channel band.

Key Path	Source, Frequency, Radio Setup, Radio Standard, GSM/EDGE
<b>Example</b>	:SOUR:FREQ:CHAN:BAND GSM450
Initial S/W Revision	A.05.00

**GSM 480**

Selects GSM 480 as the active channel band.

Key Path	Source, Frequency, Radio Setup, Radio Standard, GSM/EDGE
<b>Example</b>	:SOUR:FREQ:CHAN:BAND GSM480
Initial S/W Revision	A.05.00

**GSM 850**

Selects GSM 850 as the active channel band.

Key Path	Source, Frequency, Radio Setup, Radio Standard, GSM/EDGE
<b>Example</b>	:SOUR:FREQ:CHAN:BAND GSM850
Initial S/W Revision	A.05.00

**GSM 700**

Selects GSM 700 as the active channel band.

Key Path	Source, Frequency, Radio Setup, Radio Standard, GSM/EDGE
<b>Example</b>	:SOUR:FREQ:CHAN:BAND GSM700
Initial S/W Revision	A.05.00

**T-GSM 810**

Selects T-GSM 810 as the active channel band.

Key Path	Source, Frequency, Radio Setup, Radio Standard, GSM/EDGE
<b>Example</b>	:SOUR:FREQ:CHAN:BAND T-GSM810
Initial S/W Revision	A.05.00

**WCDMA**

Sets WCDMA as the radio standard for use and accesses the W-CDMA specific channel band sub-menus.

Key Path	Source, Frequency, Radio Setup, Radio Standard
Initial S/W Revision	A.05.00

**Band I**

Selects Band I as the active channel band.

---

Key Path	Source, Frequency, Radio Setup, Radio Standard, WCDMA
<b>Example</b>	:SOUR:FREQ:CHAN:BAND BANDI
Initial S/W Revision	A.05.00

---

#### Band II

Selects Band II as the active channel band.

---

Key Path	Source, Frequency, Radio Setup, Radio Standard, WCDMA
<b>Example</b>	:SOUR:FREQ:CHAN:BAND BANDII
Initial S/W Revision	A.05.00

---

#### Band III

Selects Band III as the active channel band.

---

Key Path	Source, Frequency, Radio Setup, Radio Standard, WCDMA
<b>Example</b>	:SOUR:FREQ:CHAN:BAND BANDIII
Initial S/W Revision	A.05.00

---

#### Band IV

Selects Band IV as the active channel band.

---

Key Path	Source, Frequency, Radio Setup, Radio Standard, WCDMA
<b>Example</b>	:SOUR:FREQ:CHAN:BAND BANDIV
Initial S/W Revision	A.05.00

---

#### Band V

Selects Band V as the active channel band.

---

Key Path	Source, Frequency, Radio Setup, Radio Standard, WCDMA
<b>Example</b>	:SOUR:FREQ:CHAN:BAND BANDV
Initial S/W Revision	A.05.00

---

#### Band VI

Selects Band VI as the active channel band.

Key Path	Source, Frequency, Radio Setup, Radio Standard, WCDMA
<b>Example</b>	:SOUR:FREQ:CHAN:BAND BANDVI
Initial S/W Revision	A.05.00

#### Band VII

Selects Band VII as the active channel band.

Key Path	Source, Frequency, Radio Setup, Radio Standard, WCDMA
<b>Example</b>	:SOUR:FREQ:CHAN:BAND BANDVII
Initial S/W Revision	A.05.00

#### Band VIII

Selects Band VIII as the active channel band.

Key Path	Source, Frequency, Radio Setup, Radio Standard, WCDMA
<b>Example</b>	:SOUR:FREQ:CHAN:BAND BANDVIII
Initial S/W Revision	A.05.00

#### Band IX

Selects Band IX as the active channel band.

Key Path	Source, Frequency, Radio Setup, Radio Standard, WCDMA
<b>Example</b>	:SOUR:FREQ:CHAN:BAND BANDIX
Initial S/W Revision	A.05.00

#### Band X

Selects Band X as the active channel band.

Key Path	Source, Frequency, Radio Setup, Radio Standard, WCDMA
<b>Example</b>	:SOUR:FREQ:CHAN:BAND BANDX
Initial S/W Revision	A.05.00

#### Band XI

Selects Band XI as the active channel band.

---

Key Path	Source, Frequency, Radio Setup, Radio Standard, WCDMA
<b>Example</b>	:SOUR:FREQ:CHAN:BAND BANDXI
Initial S/W Revision	A.05.00

---

#### Band XII

Selects Band XII as the active channel band.

---

Key Path	Source, Frequency, Radio Setup, Radio Standard, WCDMA
<b>Example</b>	:SOUR:FREQ:CHAN:BAND BANDXII
Initial S/W Revision	A.05.00

---

#### Band XIII

Selects band XIII as the active channel band.

---

Key Path	Source, Frequency, Radio Setup, Radio Standard, WCDMA
<b>Example</b>	:SOUR:FREQ:CHAN:BAND BANDXIII
Initial S/W Revision	A.05.00

---

#### Band XIV

Selects Band XIV as the active channel band.

---

Key Path	Source, Frequency, Radio Setup, Radio Standard, WCDMA
<b>Example</b>	:SOUR:FREQ:CHAN:BAND BANDXIV
Initial S/W Revision	A.05.00

---

#### LTE

Sets LTE FDD as the radio standard for use and accesses the LTE FDD specific channel band sub-menus..

---

Key Path	Source, Frequency, Radio Setup, Radio Standard
Initial S/W Revision	A.09.50

---

#### BAND 1

Selects BAND 1 as the band for the current step.

---

Key Path	Source, Frequency, Radio Setup, Radio Standard, LTE
----------	-----------------------------------------------------

---

<b>Example</b>	:SOUR:FREQ:CHAN:BAND BAND1
Initial S/W Revision	A.09.50

#### BAND 2

Selects BAND 2 as the band for the current step.

Key Path	Source, Frequency, Radio Setup, Radio Standard, LTE
<b>Example</b>	:SOUR:FREQ:CHAN:BAND BAND2
Initial S/W Revision	A.09.50

#### BAND 3

Selects BAND 3 as the band for the current step.

Key Path	Source, Frequency, Radio Setup, Radio Standard, LTE
<b>Example</b>	:SOUR:FREQ:CHAN:BAND BAND3
Initial S/W Revision	A.09.50

#### BAND 4

Selects BAND 4 as the band for the current step.

Key Path	Source, Frequency, Radio Setup, Radio Standard, LTE
<b>Example</b>	:SOUR:FREQ:CHAN:BAND BAND4
Initial S/W Revision	A.09.50

#### BAND 5

Selects BAND 5 as the band for the current step.

Key Path	Source, Frequency, Radio Setup, Radio Standard, LTE
<b>Example</b>	:SOUR:FREQ:CHAN:BAND BAND5
Initial S/W Revision	A.09.50

#### BAND 6

Selects BAND 6 as the band for the current step.

Key Path	Source, Frequency, Radio Setup, Radio Standard, LTE
----------	-----------------------------------------------------

---

<b>Example</b>	:SOUR:FREQ:CHAN:BAND BAND6
Initial S/W Revision	A.09.50

---

#### BAND 7

Selects BAND 7 as the band for the current step.

---

Key Path	Source, Frequency, Radio Setup, Radio Standard, LTE
<b>Example</b>	:SOUR:FREQ:CHAN:BAND BAND7
Initial S/W Revision	A.09.50

---

#### BAND 8

Selects BAND 8 as the band for the current step.

---

Key Path	Source, Frequency, Radio Setup, Radio Standard, LTE
<b>Example</b>	:SOUR:FREQ:CHAN:BAND BAND8
Initial S/W Revision	A.09.50

---

#### BAND 9

Selects BAND 9 as the band for the current step.

---

Key Path	Source, Frequency, Radio Setup, Radio Standard, LTE
<b>Example</b>	:SOUR:FREQ:CHAN:BAND BAND9
Initial S/W Revision	A.09.50

---

#### BAND 10

Selects BAND 10 as the band for the current step.

---

Key Path	Source, Frequency, Radio Setup, Radio Standard, LTE
<b>Example</b>	:SOUR:FREQ:CHAN:BAND BAND10
Initial S/W Revision	A.09.50

---

#### BAND 11

Selects BAND 11 as the band for the current step.

---

Key Path	Source, Frequency, Radio Setup, Radio Standard, LTE
----------	-----------------------------------------------------

---



<b>Example</b>	:SOUR:FREQ:CHAN:BAND BAND11
Initial S/W Revision	A.09.50

#### BAND 12

Selects BAND 12 as the band for the current step.

Key Path	Source, Frequency, Radio Setup, Radio Standard, LTE
<b>Example</b>	:SOUR:FREQ:CHAN:BAND BAND12
Initial S/W Revision	A.09.50

#### BAND 13

Selects BAND 13 as the band for the current step.

Key Path	Source, Frequency, Radio Setup, Radio Standard, LTE
<b>Example</b>	:SOUR:FREQ:CHAN:BAND BAND13
Initial S/W Revision	A.09.50

#### BAND 14

Selects BAND 14 as the band for the current step.

Key Path	Source, Frequency, Radio Setup, Radio Standard, LTE
<b>Example</b>	:SOUR:FREQ:CHAN:BAND BAND14
Initial S/W Revision	A.09.50

#### BAND 17

Selects BAND 17 as the band for the current step.

Key Path	Source, Frequency, Radio Setup, Radio Standard, LTE
<b>Example</b>	:SOUR:FREQ:CHAN:BAND BAND17
Initial S/W Revision	A.09.50

#### BAND 18

Selects BAND 18 as the band for the current step.

Key Path	Source, Frequency, Radio Setup, Radio Standard, LTE
----------	-----------------------------------------------------

---

<b>Example</b>	:SOUR:FREQ:CHAN:BAND BAND18
Initial S/W Revision	A.09.50

---

#### BAND 19

Selects BAND 19 as the band for the current step.

---

Key Path	Source, Frequency, Radio Setup, Radio Standard, LTE
<b>Example</b>	:SOUR:FREQ:CHAN:BAND BAND19
Initial S/W Revision	A.09.50

---

#### BAND 20

Selects BAND 20 as the band for the current step.

---

Key Path	Source, Frequency, Radio Setup, Radio Standard, LTE
<b>Example</b>	:SOUR:FREQ:CHAN:BAND BAND20
Initial S/W Revision	A.09.50

---

#### BAND 21

Selects BAND 21 as the band for the current step.

---

Key Path	Source, Frequency, Radio Setup, Radio Standard, LTE
<b>Example</b>	:SOUR:FREQ:CHAN:BAND BAND21
Initial S/W Revision	A.09.50

---

#### BAND 24

Selects BAND 24 as the band for the current step.

---

Key Path	Source, Frequency, Radio Setup, Radio Standard, LTE
<b>Example</b>	:SOUR:FREQ:CHAN:BAND BAND24
Initial S/W Revision	A.09.50

---

#### BAND 25

Selects BAND 25 as the band for the current step.

---

Key Path	Source, Frequency, Radio Setup, Radio Standard, LTE
----------	-----------------------------------------------------

---

<b>Example</b>	:SOUR:FREQ:CHAN:BAND BAND25
Initial S/W Revision	A.09.50

#### BAND 26

Selects BAND 26 as the band for the current step.

Key Path	Source, Frequency, Radio Setup, Radio Standard, LTE
<b>Example</b>	:SOUR:FREQ:CHAN:BAND BAND26
Initial S/W Revision	A.12.53

#### BAND 27

Selects BAND 27 as the band for the current step.

Key Path	Source, Frequency, Radio Setup, Radio Standard, LTE
<b>Example</b>	:SOUR:FREQ:CHAN:BAND BAND27
Initial S/W Revision	A.14.00

#### BAND 28

Selects BAND 28 as the band for the current step.

Key Path	Source, Frequency, Radio Setup, Radio Standard, LTE
<b>Example</b>	:SOUR:FREQ:CHAN:BAND BAND28
Initial S/W Revision	A.14.00

#### BAND 31

Selects BAND 31 as the band for the current step.

Key Path	Source, Frequency, Radio Setup, Radio Standard, LTE
<b>Example</b>	:SOUR:FREQ:CHAN:BAND BAND31
Initial S/W Revision	A.14.00

#### LTE TDD

Sets LTE TDD as the radio standard for use and accesses the LTE TDD specific channel band sub-menus..

Key Path	Source, Frequency, Radio Setup, Radio Standard
Initial S/W Revision	A.11.50

### BAND 33

Selects BAND 33 as the band for the current step.

Key Path	Source, Frequency, Radio Setup, Radio Standard, LTE TDD
<b>Example</b>	:SOUR:FREQ:CHAN:BAND BAND33
Initial S/W Revision	A.11.50

### BAND 34

Selects BAND 34 as the band for the current step.

Key Path	Source, Frequency, Radio Setup, Radio Standard, LTE TDD
<b>Example</b>	:SOUR:FREQ:CHAN:BAND BAND34
Initial S/W Revision	A.11.50

### BAND 35

Selects BAND 35 as the band for the current step.

Key Path	Source, Frequency, Radio Setup, Radio Standard, LTE TDD
<b>Example</b>	:SOUR:FREQ:CHAN:BAND BAND35
Initial S/W Revision	A.11.50

### BAND 36

Selects BAND 36 as the band for the current step.

Key Path	Source, Frequency, Radio Setup, Radio Standard, LTE TDD
<b>Example</b>	:SOUR:FREQ:CHAN:BAND BAND36
Initial S/W Revision	A.11.50

### BAND 37

Selects BAND 37 as the band for the current step.

Key Path	Source, Frequency, Radio Setup, Radio Standard, LTE TDD
<b>Example</b>	:SOUR:FREQ:CHAN:BAND BAND37
Initial S/W Revision	A.11.50

**BAND 38**

Selects BAND 38 as the band for the current step.

Key Path	Source, Frequency, Radio Setup, Radio Standard, LTE TDD
<b>Example</b>	:SOUR:FREQ:CHAN:BAND BAND38
Initial S/W Revision	A.11.50

**BAND 39**

Selects BAND 39 as the band for the current step.

Key Path	Source, Frequency, Radio Setup, Radio Standard, LTE TDD
<b>Example</b>	:SOUR:FREQ:CHAN:BAND BAND39
Initial S/W Revision	A.11.50

**BAND 40**

Selects BAND 40 as the band for the current step.

Key Path	Source, Frequency, Radio Setup, Radio Standard, LTE TDD
<b>Example</b>	:SOUR:FREQ:CHAN:BAND BAND40
Initial S/W Revision	A.11.50

**BAND 41**

Selects BAND 41 as the band for the current step.

Key Path	Source, Frequency, Radio Setup, Radio Standard, LTE TDD
<b>Example</b>	:SOUR:FREQ:CHAN:BAND BAND41
Initial S/W Revision	A.11.50

**BAND 42**

Selects BAND 42 as the band for the current step.

Key Path	Source, Frequency, Radio Setup, Radio Standard, LTE TDD
<b>Example</b>	:SOUR:FREQ:CHAN:BAND BAND42
Initial S/W Revision	A.11.50

### BAND 43

Selects BAND 43 as the band for the current step.

Key Path	Source, Frequency, Radio Setup, Radio Standard, LTE TDD
<b>Example</b>	:SOUR:FREQ:CHAN:BAND BAND43
Initial S/W Revision	A.11.50

### BAND 44

Selects BAND 44 as the band for the current step.

Key Path	Source, Frequency, Radio Setup, Radio Standard, LTE TDD
<b>Example</b>	:SOUR:FREQ:CHAN:BAND BAND44
Initial S/W Revision	A.14.00

### TDSCDMA

Sets TDSCDMA as the radio standard for use and accesses the TDSCDMA specific channel band sub-menus..

Key Path	Source, Frequency, Radio Setup, Radio Standard
Initial S/W Revision	A.11.50

### BAND A

Selects BAND A as the band for the current step.

Key Path	Source, Frequency, Radio Setup, Radio Standard, TDSCDMA
<b>Example</b>	:SOUR:FREQ:CHAN:BAND BANDA
Initial S/W Revision	A.11.50

### BAND B

Selects BAND B as the band for the current step.

Key Path	Source, Frequency, Radio Setup, Radio Standard, TDSCDMA
<b>Example</b>	:SOUR:FREQ:CHAN:BAND BANDB
Initial S/W Revision	A.11.50

### BAND C

Selects BAND C as the band for the current step.

Key Path	Source, Frequency, Radio Setup, Radio Standard, TDSCDMA
<b>Example</b>	:SOUR:FREQ:CHAN:BAND BANDC
Initial S/W Revision	A.11.50

#### BAND D

Selects BAND D as the band for the current step.

Key Path	Source, Frequency, Radio Setup, Radio Standard, TDSCDMA
<b>Example</b>	:SOUR:FREQ:CHAN:BAND BANDD
Initial S/W Revision	A.11.50

#### BAND E

Selects BAND E as the band for the current step.

Key Path	Source, Frequency, Radio Setup, Radio Standard, TDSCDMA
<b>Example</b>	:SOUR:FREQ:CHAN:BAND BANDE
Initial S/W Revision	A.11.50

#### BAND F

Selects BAND F as the band for the current step.

Key Path	Source, Frequency, Radio Setup, Radio Standard, TDSCDMA
<b>Example</b>	:SOUR:FREQ:CHAN:BAND BANDF
Initial S/W Revision	A.11.50

#### Radio Band Link

Allows you to specify the channel band type as either uplink or downlink link direction. This value is used in conjunction with the channel band and channel number to determine the absolute frequency output by the source. When set to “Uplink”, the source will calculate the uplink frequency using an uplink formula together with the selected channel band and channel number . When set to “Downlink”, the source will calculate the downlink frequency using a downlink formula together with the selected channel band and channel number.

Key Path	Source, Frequency, Radio Setup
<b>Remote Command</b>	:SOURce:RADio:BAND:LINK DOWN UP :SOURce:RADio:BAND:LINK?

<b>Example</b>	:SOUR:RAD:BAND:LINK UP
<b>Preset</b>	DOWN
<b>Range</b>	DOWN   UP
<b>Backwards Compatibility SCPI</b>	:SOURce:RADio:DEVIce BTS MS :SOURce:RADio:DEVIce?
<b>Backwards Compatibility Notes</b>	BTS maps to the Downlink frequency MS maps to the Uplink frequency
<b>Initial S/W Revision</b>	A.05.00

### Set Reference Frequency

This key allows you to set the frequency reference. Pressing this key turns the frequency reference state to ON, sets the reference frequency value to the current frequency, maintains this frequency at the RF output, and sets the displayed frequency to 0.00 Hz. All subsequent frequencies entered under Source>Frequency>Frequency are interpreted as being relative to this reference frequency.

When you use a frequency reference, the signal generator outputs a frequency that is set relative to the reference frequency by the value entered under Source>Frequency>Frequency as follows:

Output frequency = reference frequency - entered frequency

Where:

reference frequency equals the original RF frequency entered under Source>Frequency>Frequency and set as the reference frequency

entered frequency equals a new value entered under Source>Frequency>Frequency

In addition, the displayed frequency value will be the same as the value entered under Source>Frequency>Frequency.

**NOTE**

If Freq Reference is set to ON with a reference value set, entering a value under Source>Frequency>Frequency and pressing Set Frequency Reference will add that value to the existing Freq Reference value.

If you wish to change the reference frequency value to the new value entered under Source>Frequency>Frequency, first you must set Freq Reference to OFF and then press Set Frequency Reference.

<b>Key Path</b>	Source, Frequency
<b>Remote Command</b>	:SOURce:FREQuency:REFerence:SET
<b>Example</b>	:SOUR:FREQ:REF:SET
<b>Dependencies</b>	This setting is unavailable, and is grayed out when the List Sequencer is turned ON.
<b>Initial S/W Revision</b>	A.05.00



## Freq Reference

This key allows you to toggle the state of the frequency reference. When the frequency reference state is ON, an annunciator is displayed on the main source view to indicate this state to the user.

When you use a frequency reference, the signal generator outputs a frequency that is set relative to the reference frequency by the value entered under Source>Frequency>Frequency as follows:

Output frequency = reference frequency + entered frequency

Where:

reference frequency equals the original RF frequency entered under Source>Frequency>Frequency and set as the reference frequency

entered frequency equals a new value entered under Source>Frequency>Frequency

For more information on Reference Frequency refer to ["Set Reference Frequency" on page 1408](#)

Key Path	Source, Frequency
<b>Remote Command</b>	:SOURce:FREQuency:REFerence <freq> :SOURce:FREQuency:REFerence? :SOURce:FREQuency:REFerence:STATe OFF ON 0 1 :SOURce:FREQuency:REFerence:STATe?
<b>Example</b>	:SOUR:FREQ:REF 0.00 Hz :SOUR:FREQ:REF:STATe ON
Dependencies	This setting is unavailable, and is grayed out when the List Sequencer is turned ON.
Couplings	The frequency reference state is coupled to the frequency reference set immediate action. When the reference set immediate action key is pressed, or the SCPI command issued, it turns the frequency reference state ON.
Preset	0.00 Hz OFF
Min	0.00 Hz
Max	Hardware Dependant: Option 503 = 3.6 GHz Option 504 = 3.8 GHz Option 506 = 6.00 GHz
Initial S/W Revision	A.05.00

## Freq Offset

Allows you to specify the frequency offset value. When the frequency offset state is ON, an annunciator is displayed on the main source view to indicate this state to the user.

When the frequency offset is set to zero (0) and you set a new offset value, the displayed frequency value will change as follows and the RF output frequency will not change:

Displayed value = output frequency + offset value

Where:

output frequency equals the original frequency entered under Source>Frequency>Frequency

offset value equals the value entered under Source>Frequency>Freq Offset

When the frequency offset is set to a value other than zero (0) and you enter a new frequency value under Source>Frequency>Frequency, the displayed frequency will be the same as the value entered and the RF output frequency will be equal to the value entered minus the offset value as follows:

Output frequency = entered frequency – offset frequency

Displayed frequency = output frequency + offset frequency

Displayed frequency = entered frequency

Where:

entered frequency equals the frequency entered under Source>Frequency>Frequency

offset frequency equals the value previously entered and set under Source>Frequency>Freq Offset

Key Path	Source, Frequency
Remote Command	:SOURce:FREQuency:OFFSet <freq> :SOURce:FREQuency:OFFSet?
Example	:SOUR:FREQ:OFFS 0 Hz
Dependencies	This setting is unavailable, and is grayed out when the List Sequencer is turned ON.
Preset	0 Hz
Min	-100.00 GHz
Max	100.00 GHz
Initial S/W Revision	A.05.00

## Modulation Setup

Allows access to the menus for setting up the available modulation types: "ARB" on page 1424, "AM" on page 1445, "FM" on page 1446, and "PM" on page 1448.

Key Path	Source
Initial S/W Revision	A.05.00

## ARB

Allows you access to the ARB sub-menus.

Key Path	Source, Modulation Setup
Initial S/W Revision	A.05.00

## ARB

Allows you to toggle the state of the ARB function. When the ARB is On, a “MOD” annunciator is displayed in the system settings panel. When the ARB is turned Off, the MOD annunciator is cleared

Key Path	Source, Modulation Setup, ARB
Remote Command	:SOURce:RADio:ARB[:STATe] ON OFF 1 0 :SOURce:RADio:ARB[:STATe]?
Example	:SOUR:RAD:ARB OFF :SOUR:RAD:ARB?
Notes	If the ARB is ON, a user then loads or deletes another file to ARB memory, the playing waveform segment may not keep phase continuity during the ARB memory operation. The waveform will be replayed after the ARB operation is finished.
Dependencies	This setting is for independent mode and has no effect on 3.3.8 list sequencer mode. Setting <b>"Sequencer" on page 1449</b> Sequencer to On will put source enter list sequencer mode, and even if ARB state is On, the ARB file will not be played. Setting <b>"Sequencer" on page 1449</b> Sequencer to Off will make source leave list sequencer mode, and this setting will take effect immediately. The ARB can only be turned on when there is a waveform file selected for playback. On the GUI If no waveform is selected, this key is grayed out. If you send the SCPI command to turn the ARB on with no waveform selected for playback, the ARB state remains OFF and an error is generated. "- When you try to recall a certain set of states in which the selected waveform is not in ARB memory and the ARB state is On, errors are reported
Preset	Off
Range	On   Off
Initial S/W Revision	A.05.00

## Select Waveform

Allows you to access to the waveform selection sub-menus.

Pressing this key changes the central view area to show the Waveform File Selection view.

Key Path	Source, Modulation Setup, ARB
Initial S/W Revision	A.05.00

## Select Waveform

Allows you to select a waveform sequence or segment for the dual ARB to play.

NOTE: Selecting a waveform file does not result in automatic adjustments to burst timing (to compensate for the presence or absence of a Multiport Adapter); that adjustment occurs only when a waveform is loaded to ARB memory. See "Load Segment to ARB Memory" for more information about this adjustment.

<b>Key Path</b>	Source, Modulation Setup, ARB, Select Waveform
<b>Remote Command</b>	:SOURCE:RADio:ARB:WAVEform <string> :SOURCE:RADio:ARB:WAVEform?
<b>Example</b>	:SOUR:RAD:ARB:WAV "test_waveform.bin"
<b>Notes</b>	<p>If intended waveform is not in the memory yet, then issuing this command by SCPI will invoke ARB loading operation first, which involves a delay of unpredictable length. So this command should be followed by the query *OPC?, which holds off subsequent commands until the loading operation is complete.</p> <p>&lt;string&gt; - specifies the name of the waveform segment or waveform sequence to be played by the ARB.</p> <p>When in Sequence Analyzer mode, and Include Source is Yes, if the you attempt to play a waveform sequence but not all the required waveform segments are in the ARB playback memory, the application will reject the loading operation with an error is generated .</p> <p>When Include Source is No, if you attempt to play a waveform sequence but not all the required waveform segments are contained in the ARB playback memory, the application will attempt to load the required segments from either the default directory of the current directory. If the ARB memory does not have enough space for all the waveform segments to be loaded, an error is generated and none of the waveform segments is loaded.</p> <p>If the ARB is ON, and you attempt to play a waveform sequence but not all the waveform segments within the sequence could be found to be loaded into ARB memory, an error is generated. The selected waveform keeps the previous value and ARB state remains On.</p> <p>If you specify a waveform segment over SCPI but the waveform segment is not present within ARB playback memory and cannot be found for auto loading within the current directory or the default directory, an error is generated and the file selection remains unchanged.</p> <p>If you select a waveform for playback and the waveform requires a license that is not installed on the instrument, an error is generated. error is generated.</p> <p>If the ARB is ON and you load a file to ARB memory or delete a file from ARB memory, the playing waveform segment may not keep phase continuity during the ARB memory operation. The waveform will be replayed after the ARB operation is finished.</p>
<b>Initial S/W Revision</b>	A.05.00

### Segments on Hard Disk

Allows you access to the sub-menus for loading waveform segments from the hard disk into ARB memory. The default directory is: D: varb.

Pressing this key changes the current view to the Waveform Management View.

<b>Key Path</b>	Source, Modulation Setup, ARB, Select Waveform
<b>Initial S/W Revision</b>	A.05.00

### Load Segment To ARB Memory

Allows you to load the selected file into ARB memory. On the front panel you select the file for loading to the ARB memory by highlighting the desired file in the list. Using the SCPI command, you specify the file

name on the HDD.

“NVWFM” (none-volatile storage) MSUS (Mass Storage Unit Specifier) is supported in the memory subsystem because the ARB memory cannot be accessed directly. Therefore, files must be downloaded to the instrument hard disk and then loaded into the ARB memory. “NVWFM” MSUS will be mapped to the default directory D: VARB. The SCPI command supports using either “NVWFM” MSUS or specifying a full path. For more information, see Memory Subsystem (Remote Command Only).

If a file of the same name already exists within ARB memory, it is overwritten. If you wish to load two segments of the same name, you must rename one of the segments before loading it into ARB memory. To rename a segment, you can either use Windows File Explorer, or the :MMEMory:COpy command.

NOTE: When a waveform file is loaded to ARB memory, burst timing adjustments are made automatically, based on whether or not a Multiport Adapter is connected to the test set and powered on. If the connection/power status of the Multiport Adapter is changed after a waveform file has been loaded, it needs to be loaded again.

<b>Key Path</b>	Source, Modulation Setup, ARB, Select Waveform, Segments on Hard Disk
<b>Remote Command</b>	:SOURce:RADio:ARB:LOAD <string>
<b>Example</b>	:SOUR:RAD:ARB:LOAD "D: VARB\testwaveform.bin" or :SOUR:RAD:ARB:LOAD "NVWFM:testwaveform.bin"
<b>Notes</b>	<p>Because loading the file involves a delay of unpredictable length, this command should be followed by the query *OPC?, which holds off subsequent commands until the loading operating is complete.</p> <p>&lt;string&gt; – specifies the path name of the file to load from the HDD into ARB memory. It could be a &lt;full path + filename&gt;, or &lt;“NVWFM” MSUS + colon + filename&gt;.</p> <p>When in Sequence Analyzer mode, and Include Source is Yes, an attempt to load a file to ARB memory will be rejected with an error.</p> <p>When Include Source is No and if there is insufficient free ARB memory to load the selected waveform, an error is generated. .</p> <p>If you specify a file over SCPI, but the file is not at the specified location, an error is generated.</p> <p>If you try to load a waveform file but the file contains less than 500 IQ samples, an error is generated.</p> <p>If you try to load a Signal Studio waveform “*.wfm” which contains invalid waveform header, an error is generated.</p> <p>If the ARB is ON when you load a file to ARB memory or delete a file from ARB memory, the playing waveform segment may not keep phase continuity during the ARB memory operation. The waveform will be replayed after the ARB operation is finished.</p> <p>ARB can be loaded into ARB memory even required licenses do not present on the instrument. In this case, a GUI only warning message –800, “Operation complete; Loaded &lt;filename&gt; successfully, but no license &lt;required licenses&gt; installed”. User can install required licenses according to &lt;required licenses&gt; string to license it, or multi-pack license it.</p>
<b>Initial S/W Revision</b>	A.05.00

### Load All To ARB Memory

Allows you to load all the segment files within the currently selected directory into ARB memory. If a file of the same name already exists within ARB memory, it is overwritten. If you wish to load two segments of the

same name, you must rename one of the segments before loading it into ARB memory. To rename a segment, you can either use Windows File Explorer, or the :MEMory:COpy command.

NOTE: When a waveform file is loaded to ARB memory, burst timing adjustments are made automatically, based on whether or not a Multiport Adapter is connected to the test set and powered on. If the connection/power status of the Multiport Adapter is changed after a waveform file has been loaded, it needs to be loaded again.

<b>Key Path</b>	Source, Modulation Setup, ARB, Select Waveform, Segments on Hard Disk
<b>Remote Command</b>	:SOURce:RADio:ARB:LOAD:ALL <string>
<b>Example</b>	:SOUR:RAD:ARB:LOAD:ALL "D: varb"
<b>Notes</b>	<p>&lt;string&gt; - specifies the directory on the HDD to load the files into ARB memory from.</p> <p>When in Sequence Analyzer mode, and Include Source is Yes, an attempt to load all files from a directory to ARB memory is rejected with an error.</p> <p>When Include Source is No and there is insufficient free ARB memory to load all the waveforms, when the ARB memory is full, the copy ceases, and an error is generated.</p> <p>If you specify a directory over SCPI, but the directory does not exist, an error is generated.</p> <p>If the ARB is ON, a user then loads or deletes file to ARB memory, the playing waveform segment may not keep phase continuity during the ARB memory operation. The waveform will be replayed after the ARB operation is finished.</p>
<b>Initial S/W Revision</b>	A.05.00

#### Change Directory...

Allows you to change the currently selected directory on the hard disk. Pressing this key opens a standard windows change directory dialog allowing you to select the new directory of interest.

The current directory is used for manually loading waveform segments into ARB memory for playback, and as a search location for waveform segments that are required to be loaded into ARB memory for playback of a waveform sequence or a list sequence.

<b>Key Path</b>	Source, Modulation Setup, ARB, Select Waveform, Segments on Hard Disk
<b>Notes</b>	No remote command, SCPIfront panel only.
<b>Initial S/W Revision</b>	A.05.00

#### Default Directory...

Allows you to change the default directory. It is used as a search location for waveform segments that are required to be loaded into ARB memory for playback of a waveform sequence, and as a search location for selecting waveforms using SCPI.

<b>Key Path</b>	Source, Modulation Setup, ARB, Select Waveform, Segments on Hard Disk
<b>Remote Command</b>	:SOURce:RADio:ARB:DEFault:DIRectory <string> :SOURce:RADio:ARB: DEFault:DIRectory?
<b>Example</b>	:SOUR:RAD:ARB:DEF:DIR "D:\ArbFiles"

	:SOUR:RAD:ARB:DEF:DIR?
State Saved	Persistent, survives a power cycle and a preset but not saved in the instrument state
Initial S/W Revision	A.05.00

### Segments in ARB Memory

Allows you access to the sub-menus for managing the files within ARB memory.

Key Path	Source, Modulation Setup, ARB, Select Waveform
Initial S/W Revision	A.05.00

### Delete Segment From ARB Mem

Allows you to remove a segment from ARB playback memory.

Key Path	Source, Modulation Setup, ARB, Select Waveform, Segments in ARB Memory
<b>Remote Command</b>	:SOURce:RADio:ARB:DELeTe <string>
<b>Example</b>	:SOUR:RAD:ARB:DEL "testwaveform.bin"
Notes	<p>&lt;string&gt; - specifies the waveform to be deleted from the ARB playback memory.</p> <p>When in Sequence Analyzer mode and Include Source is Yes, an attempt to delete a file from ARB memory is rejected with an error.</p> <p>When Include Source is No and you specify a file that does not exist within ARB memory, an error is generated.</p> <p>It is possible to delete files from within the ARB memory when the ARB is ON. However, if you attempt to delete the file that is currently playing an error is generated.</p> <p>It is possible to delete a file from within the ARB memory when the sequencer state is ON and the file is not being used by the List Sequencer. If you attempt to delete a file which is being used by the list sequencer, an error is generated.</p> <p>When sequencer state is On, even if ARB state is On, the selected waveform will not be played. In this case, if the selected waveform is not used in List Sequence, it can be deleted and the ARB state is turned Off.</p> <p>If the ARB is ON and you load a file to ARB memory or delete a file from ARB memory, the playing waveform segment may not keep phase continuity during the ARB memory operation. The waveform will be replayed after the ARB operation is finished.</p>
Initial S/W Revision	A.05.00

### Delete All From ARB Memory

Allows you to remove all segments from ARB playback memory.

Key Path	Source, Modulation Setup, ARB, Select Waveform, Segments in ARB Memory
----------	------------------------------------------------------------------------

<b>Remote Command</b>	:SOURce:RADio:ARB:DELeTe:ALL
<b>Example</b>	:SOUR:RAD:ARB:DELeTe:ALL
<b>Notes</b>	<p>When in Sequence Analyzer mode and Include Source is Yes, an attempt to delete all files from ARB memory is rejected with an error.</p> <p>When Include Source is No and you attempt to delete all files from ARB memory when the ARB is currently playing a file, all files except the one playing are deleted and an error is generated.</p> <p>If you attempt to delete all files from ARB memory when there are waveform files used in "List Sequencer" on page 1449 and "Sequencer" on page 1449 state is ON, all files except the files currently being used in list sequencer are deleted, and an error is generated.</p> <p>If the ARB is ON and you load a file to ARB memory or delete a file from ARB memory, the playing waveform segment may not keep phase continuity during the ARB memory operation. The waveform will be replayed after the ARB operation is finished.</p>
<b>Initial S/W Revision</b>	A.05.00

### ARB Setup

Allows access to the ARB setup sub-menus.

<b>Key Path</b>	Source, Modulation Setup, ARB
<b>Initial S/W Revision</b>	A.05.00

### Sample Rate

Allows you to set the ARB waveform playback sample rate.

<b>Key Path</b>	Source, Modulation Setup, ARB, ARB Setup
<b>Remote Command</b>	:SOURce:RADio:ARB:SCLock:RATE <freq> :SOURce:RADio:ARB:SCLock:RATE?
<b>Example</b>	:SOUR:RAD:ARB:SCL:RATE 48.00 MHz
<b>Notes</b>	If there is a sample rate specified in the header of the waveform file, changing that sample rate is not recommended, as it may cause problems with burst timing.
<b>Dependencies</b>	When a new waveform is selected for playback the settings contained within the associated waveform header file are applied to the ARB. The sample rate is one of the values stored within the header file. If the newly selected waveform file has an associated header file, the sample rate is updated with the value from the header file. The sample rate will remain unchanged if the newly selected waveform does not have an associated header file.
<b>Preset</b>	125.00 MHz
<b>Min</b>	1.00 kHz
<b>Max</b>	125.00 MHz
<b>Initial S/W Revision</b>	A.05.00



### Run-Time Scaling

Allows you to adjust the run-time scaling value. The run-time scaling value is applied in real-time while the waveform is playing.

<b>Key Path</b>	Source, Modulation Setup, ARB, ARB Setup
<b>Remote Command</b>	:SOURce:RADio:ARB:RSCaling <real> :SOURce:RADio:ARB:RSCaling?
<b>Example</b>	:SOUR:RAD:ARB:RSC 100.00
<b>Notes</b>	This setting cannot be set in E6640A/M9420A. Grey out on menu and the value is fixed at 70.00%.
<b>Dependencies</b>	When a new waveform is selected for playback the settings contained within the associated waveform header file are applied to the ARB. The run-time scaling is one of the values stored within the header file. If the newly selected waveform file has an associated header file, the run-time scaling is updated with the value from the header file. The run-time scaling will remain unchanged if the newly selected waveform does not have an associated header file.
<b>Preset</b>	70.00 %
<b>Min</b>	1.00 %
<b>Max</b>	100.00 %
<b>Initial S/W Revision</b>	A.05.00

### Baseband Freq Offset

Allows you to adjust the value by which the baseband frequency is offset relative to the carrier.

<b>Key Path</b>	Source, Modulation Setup, ARB, ARB Setup
<b>Remote Command</b>	:SOURce:RADio:ARB:BASEband:FREQuency:OFFSet <freq> :SOURce:RADio:ARB:BASEband:FREQuency:OFFSet?
<b>Example</b>	:SOUR:RAD:ARB:BAS:FREQ:OFFS 0.00 Hz
<b>Dependencies</b>	When a new waveform is selected for playback the settings contained within the associated waveform header file are applied to the ARB. The baseband frequency offset is one of the values stored within the header file. If the newly selected waveform file has an associated header file, the baseband frequency offset is updated with the value from the header file. The baseband frequency offset will remain unchanged if the newly selected waveform does not have an associated header file.
<b>Preset</b>	0.00 Hz
<b>Min</b>	-50.00 MHz
<b>Max</b>	50.00 MHz
<b>Initial S/W Revision</b>	A.05.00

### Edit RMS

Allows you to edit or calculate current RMS of selected waveform.

Key Path	Source, Modulation Setup, ARB, ARB Setup
Initial S/W Revision	A.14.50

### Current RMS

Allows you to directly specify current RMS value used to playback currently selected waveform. Please note incorrect RMS value may cause inaccurate power output in E6640A/M9420A that is sensitive to RMS value.

This setting is also updated by RMS in waveform header or updated when invoking RMS calculation operation.

This setting can be saved to the header of currently selected waveform by invoking ["Save Setup To Header" on page 1445](#) "Save Setup To Header".

Key Path	Source, Modulation Setup, ARB, ARB Setup, Edit RMS
Remote Command	:SOURce:RADio:ARB:RMS <float> :SOURce:RADio:ARB:RMS?
Example	:SOUR:RAD:ARB:HEAD:RMS 0.7 :SOUR:RAD:ARB:HEAD:RMS?
Notes	Valid range is 0 to 1.414, values outside the range will be clipped to the closest boundary. Note this value does not affect <a href="#">"List Sequencer" on page 1449</a> Source List Sequencer that always uses RMS value resides in each ARB header. If want this value to take effect in list sequencer, use <a href="#">"Save Setup To Header" on page 1445</a> "Save Setup to Header" to save current RMS value to header first, then play the ARB in source list sequencer.
Dependencies	When a new waveform is selected for playback, this setting is updated by the RMS value defined in associated waveform header file. If selected waveform has no associated header file or header file does not specify RMS value, then instrument will try to calculate out one automatically. Calculating RMS can also update this setting.
Preset	0
Range	0 ~ 1.414
Initial S/W Revision	A.14.50

### RMS Calculation Mode

Allows you to specify the mode to calculate the current RMS.

Key Path	Source, Modulation Setup, ARB, ARB Setup, Edit RMS
Remote Command	:SOURce:RADio:ARB:RMS:CALCulation:MODE AUTO   M1   M2   M3   M4 :SOURce:RADio:ARB:RMS:CALCulation:MODE?
Example	:SOUR:RAD:ARB:RMS:CALC:MODE AUTO
Notes	If no waveform is selected, or selected waveform is waveform sequence, the key will grey out.

Preset	AUTO
Range	AUTO   M1   M2   M3   M4
Initial S/W Revision	A.14.50

### Auto

RMS will be calculated based on the whole sample range of current selected waveform.

Key Path	Source, Modulation Setup, ARB, ARB Setup, Edit RMS, Calculate RMS, RMS Calculation Mode
<b>Example</b>	:SOUR:RAD:ARB:RMS:CALC:MODE AUTO
Initial S/W Revision	A.14.50

### Marker 1

Selects marker 1 to designate sample range used for RMS calculation.

Key Path	Source, Modulation Setup, ARB, ARB Setup, Edit RMS, Calculate RMS, RMS Calculation Mode , Marker
<b>Example</b>	:SOUR:RAD:ARB:RMS:CALC:MODE M1
Initial S/W Revision	A.14.50

### Marker 2

Selects marker 2 to designate sample range used for RMS calculation.

Key Path	Source, Modulation Setup, ARB, ARB Setup, Edit RMS, Calculate RMS, RMS Calculation Mode , Marker
<b>Example</b>	:SOUR:RAD:ARB:RMS:CALC:MODE M2
Initial S/W Revision	A.14.50

### Marker 3

Selects marker 3 to designate sample range used for RMS calculation.

Key Path	Source, Modulation Setup, ARB, ARB Setup, Edit RMS, Calculate RMS, RMS Calculation Mode , Marker
<b>Example</b>	:SOUR:RAD:ARB:RMS:CALC:MODE M3
Initial S/W Revision	A.14.50

#### Marker 4

Selects marker 4 to designate sample range used for RMS calculation.

Key Path	Source, Modulation Setup, ARB, ARB Setup, Edit RMS, Calculate RMS, RMS Calculation Mode , Marker
<b>Example</b>	:SOUR:RAD:ARB:RMS:CALC:MODE M4
Initial S/W Revision	A.14.50

#### Calculate RMS

Allows you to calculate current RMS based on mode selected. This will update "[Current RMS](#)" on page 1418 Current RMS setting.

Key Path	Source, Modulation Setup, ARB, ARB Setup, Edit RMS, Calculate RMS
<b>Remote Command</b>	:SOURce:RADio:ARB:RMS:CALCulate
<b>Example</b>	:SOUR:RAD:ARB:RMS:CALC
Notes	<p>If no waveform is selected, invoking this operation will get error “-221 Setting conflict; No waveform is selected for RMS operation”.</p> <p>If no waveform is selected, or selected waveform is waveform sequence, the key will grey out.</p> <p>If selected waveform does not contain marker data, but "<a href="#">RMS Calculation Mode</a>" on page 1418 “RMS Calculation Mode” is set to marker, under this circumstance, invoking calculation operation will get error “-221 Setting conflict; There is no marker for currently selected waveform, auto RMS calculation mode is used instead”, and "<a href="#">RMS Calculation Mode</a>" on page 1418 “RMS Calculation Mode” will be coupled to “Auto” mode automatically.</p> <p>RMS calculation does not suit for waveform sequence. If selected waveform is waveform sequence file, invoking this operation will get error “-221 Setting conflict; RMS calculation does not apply to waveform sequence”. But users can still edit current RMS as play parameter, and can save current RMS to waveform sequence header for later use.</p>
Initial S/W Revision	A.14.50

#### Use Header RMS

Allows you to quickly set RMS in ARB header to "[Current RMS](#)" on page 1418 Current RMS setting.

Key Path	Source, Modulation Setup, ARB, ARB Setup, Edit RMS,
Notes	<p>No remote command, front panel only.</p> <p>If no waveform is selected, the key will grey out.</p> <p>If no waveform is selected, invoking this operation will get error “-221 Setting conflict; No waveform is selected for RMS operation”.</p>
Initial S/W Revision	A.14.50

## Trigger Type

Allows access to the trigger type sub-menus. The setting for trigger type determines the behavior of the waveform when it plays.

Key Path	Source, Modulation Setup, ARB
Remote Command	:SOURce:RADio:ARB:TRIGger:TYPE CONTInuous   SINGle   SADVance :SOURce:RADio:ARB:TRIGger:TYPE?
Example	:SOUR:RAD:ARB:TRIG:TYPE CONT :SOUR:RAD:ARB:TRIG:TYPE?
Notes	Gated trigger type will be implemented at a later release
Preset	CONTInuous
Range	Continuous   Single   Seg Adv
Initial S/W Revision	A.05.00

### Continuous

Sets the active trigger type to Continuous. If Continuous is already selected as the active trigger type, pressing this key allows access to the continuous trigger type setup menu. In Continuous trigger mode, the waveform repeats continuously.

Key Path	Source, Modulation Setup, ARB, Trigger Type
Remote Command	:SOURce:RADio:ARB:TRIGger:TYPE:CONTInuous[:TYPE] FREE   TRIGger   RESet :SOURce:RADio:ARB:TRIGger:TYPE:CONTInuous[:TYPE]?
Example	:SOUR:RAD:ARB:TRIG:TYPE:CONT FREE
Preset	FREE
Range	Free Run   Trigger + Run   Reset + Run
Initial S/W Revision	A.05.00

### Free Run

Selects Free Run as the trigger response for the continuous trigger type. Free Run sets the waveform generator to play a waveform sequence or segment continuously, without waiting for a trigger. In this mode, the waveform generator does not respond to triggers.

Key Path	Source, Modulation Setup, ARB, Trigger Type, Continuous
Example	:SOUR:RAD:ARB:TRIG:TYPE:CONT FREE
Initial S/W Revision	A.05.00

### Trigger + Run

Sets Trigger and Run as the trigger response for the continuous trigger type. Trigger and Run sets the waveform generator to play a waveform sequence or segment continuously when the first trigger is received, and to ignore any subsequent triggers.

Key Path	Source, Modulation Setup, ARB, Trigger Type, Continuous
<b>Example</b>	:SOUR:RAD:ARB:TRIG:TYPE:CONT TRIG
Initial S/W Revision	A.05.00

### Reset + Run

Sets Reset and Run as the trigger response for the continuous trigger type. Reset and Run sets the waveform generator to play a waveform sequence or segment continuously when the first trigger is received. Subsequent triggers reset the waveform sequence or segment to the start, and then play it continuously.

Key Path	Source, Modulation Setup, ARB, Trigger Type, Continuous
<b>Example</b>	:SOUR:RAD:ARB:TRIG:TYPE:CONT RES
Initial S/W Revision	A.05.00

### Single

Sets the active trigger type to Single. If Single is already selected as the active trigger type, pressing this key allows access to the single trigger type setup menu. In Single trigger mode, the waveform plays once.

Key Path	Source, Modulation Setup, ARB, Trigger Type
<b>Remote Command</b>	:SOURce:RADio:ARB:RETRigger ON OFF IMMediate :SOURce:RADio:ARB:RETRigger?
<b>Example</b>	:SOUR:RAD:ARB:RETR OFF
Notes	ON: Buffered Trigger OFF: No Retrigger Immediate: Restart on Trigger This is defined as an enumerated SCPI command, with ON OFF being considered as enumerated types rather than Boolean. This means the query will return OFF instead of 0, and ON instead of 1.
Preset	ON
Range	No Retrigger   Buffered Trigger   Restart on Trigger
Initial S/W Revision	A.05.00

### No Retrigger

Selects No Retrigger as the trigger response for single trigger type. No Retrigger sets the waveform generator to play a waveform sequence or segment once when a trigger is received. Any triggers then

received during playback are ignored.

<b>Key Path</b>	Source, Modulation Setup, ARB, Trigger Type, Single
<b>Example</b>	:SOUR:RAD:ARB:RETR OFF
<b>Initial S/W Revision</b>	A.05.00

### Buffered Trigger

Selects Buffered Trigger as the trigger response for single trigger type. Buffered Trigger sets the waveform generator to play a waveform sequence or segment once when a trigger is received. If a trigger is received during playback, the waveform generator plays the sequence or segment to the end, then plays the sequence or segment once more.

<b>Key Path</b>	Source, Modulation Setup, ARB, Trigger Type, Single
<b>Example</b>	:SOUR:RAD:ARB:RETR ON
<b>Initial S/W Revision</b>	A.05.00

### Restart on Trigger

Selects Restart on Trigger as the trigger response for single trigger type. Restart on Trigger sets the waveform generator to play a waveform sequence or segment once when a trigger is received. If a trigger is received during playback, the waveform generator resets and plays the sequence or segment from the start.

<b>Key Path</b>	Source, Modulation Setup, ARB, Trigger Type, Single
<b>Example</b>	:SOUR:RAD:ARB:RETR IMM
<b>Initial S/W Revision</b>	A.05.00

### Segment Advance

Sets the active trigger type to Segment Advance. If Segment Advance is already selected as the active trigger type, pressing this key allows access to the segment advance trigger type setup menu.

Segment Advance triggering allows you to control the playback of waveform segments within a waveform sequence. When a trigger is received the ARB advances to the next waveform segment within the waveform sequence. This type of triggering ignores the repetition count for the waveform segment within the waveform sequence. For example, if a waveform segment has a repetition count of 10 and you select single segment advance triggering mode, the waveform segment will only play once.

Segment Advance triggering can also be used for waveform segments only. In this situation the same waveform segment is played again when a trigger is received.

<b>Key Path</b>	Source, Modulation Setup, ARB, Trigger Type
<b>Remote Command</b>	:SOURce:RADio:ARB:TRIGger:TYPE:SADvance[:TYPE] SINGLE   CONTinuous

	:SOURce:RADio:ARB:TRIGger:TYPE:SADVance[:TYPE]?
<b>Example</b>	:SOUR:RAD:ARB:TRIG:TYPE:SADV SING
Preset	CONTInuous
Range	Single   Continuous
Initial S/W Revision	A.05.00

### Single

Selects Single as the trigger response for Segment Advance trigger type. With single selected, once a trigger is received a segment is played once. If a trigger is received during playback of a segment, the segment plays to completion and the next segment is played once.

Key Path	Source, Modulation Setup, ARB, Trigger Type, Segment Advance
<b>Example</b>	:SOUR:RAD:ARB:TRIG:TYPE:SADV SING
Initial S/W Revision	A.05.00

### Continuous

Selects Continuous as the trigger response for Segment Advance trigger type. With continuous selected, once a trigger is received a segment is played continuously. When subsequent triggers are received, the currently playing segment plays to completion and then the next segment is played continuously.

Key Path	Source, Modulation Setup, ARB, Trigger Type, Segment Advance
<b>Example</b>	:SOUR:RAD:ARB:TRIG:TYPE:SADV CONT
Initial S/W Revision	A.05.00

### ARB

Allows you access to the ARB sub-menus.

Key Path	Source, Modulation Setup
Initial S/W Revision	A.05.00

### Trigger Source

The trigger source setting determines how the source receives the trigger that starts the waveform playing. Therefore, this key is grayed out if the trigger type is free run, since free run triggers immediately with no trigger source required.

Key Path	Source, Modulation Setup, ARB
<b>Remote Command</b>	:SOURce:RADio:ARB:TRIGger[:SOURce] KEY BUS EXTeRnal2



	:SOURce:RADio:ARB:TRIGger[:SOURce]?
<b>Example</b>	:SOUR:RAD:ARB:TRIGger KEY
Dependencies	This key is grayed out if the current trigger type is Continuous, Free Run.
Preset	EXTernal2
Range	Trigger Key   Bus   External 2
Initial S/W Revision	A.05.00

### Trigger Key

Sets the current trigger source to the front panel Trigger key. When Trigger Key is selected, the waveform is triggered when you press the front panel Trigger key.

Key Path	Source, Modulation Setup, ARB, Trigger Source
<b>Example</b>	:SOUR:RAD:ARB:TRIGger KEY
Initial S/W Revision	A.05.00

### Bus

Sets the current trigger source to Bus. Selecting Bus trigger source enables triggering over GPIB, LAN, or USB using the :SOURce:RADio:ARB:TRIGger:INITiate command.

Key Path	Source, Modulation Setup, ARB, Trigger Source
<b>Example</b>	:SOUR:RAD:ARB:TRIGger BUS
Initial S/W Revision	A.05.00

### External 2

Sets the current trigger source to External 2. Selecting External 2 enables triggering a waveform by an externally applied signal.

Key Path	Source, Modulation Setup, ARB, Trigger Source
<b>Example</b>	:SOUR:RAD:ARB:TRIGger EXT2
Notes	Note: When on E6640A, trigger 2 is a bi-directional trigger port. So when trigger 2 has been configured as OUTPUT type, choosing External 2 as the input trigger for the current step will generate error.
Initial S/W Revision	A.05.00

### External Trigger Delay

This key allows you to toggle the state and value of external trigger delay. The value you enter sets a delay time between when an external trigger is received and when it is applied to the waveform. This is key is

active only if you select external trigger as trigger source.

<b>Key Path</b>	Source, Modulation Setup, ARB, Trigger Source
<b>Remote Command</b>	:SOURce:RADio:ARB:TRIGger[:SOURce]:EXTernal:DELay <time> :SOURce:RADio:ARB:TRIGger[:SOURce]:EXTernal:DELay? SOURce:RADio:ARB:TRIGger[:SOURce]:EXTernal:DELay:STATe OFF   ON   0   1 :SOURce:RADio:ARB:TRIGger[:SOURce]:EXTernal:DELay:STATe?
<b>Example</b>	:SOUR:RAD:ARB:TRIG:EXT:DEL 100ns :SOUR:RAD:ARB:TRIG:EXT:DEL? :SOUR:RAD:ARB:TRIG:EXT:DEL:STAT ON :SOUR:RAD:ARB:TRIG:EXT:DEL:STAT?
<b>Notes</b>	External trigger delay time set by users will be rounded to the nearest integer multiple of the resolution.
<b>Dependencies</b>	This setting is unavailable and is grayed out when the Trigger Source is not set to external trigger.
<b>Preset</b>	1 ms OFF
<b>Min</b>	0 s
<b>Max</b>	8.589934588 s (Note: This value comes from $4\text{ns} * (2^{31} - 1) = 8589934588\text{ ns}$ )
<b>Initial S/W Revision</b>	A.14.50

### Trigger Initiate

Used to initiate an immediate trigger event if the trigger source is set to Trigger Key.

<b>Key Path</b>	Source, Modulation Setup, ARB
<b>Notes</b>	No remote command, SCPI front panel only.
<b>Initial S/W Revision</b>	A.05.00

### Waveform Sequences

Allows access to the waveform sequence sub-menus. Pressing this key changes the central view area to display the Waveform Sequence List view.

<b>Key Path</b>	Source, Modulation Setup, ARB
<b>Notes</b>	No remote command, SCPI front panel only.
<b>Initial S/W Revision</b>	A.05.00

### Build New Sequence

Allows access to the sub-menus for creating a new waveform sequence. Pressing this key changes the central view area to display the Waveform Sequence Creation and Editing view.

Key Path	Source, Modulation Setup, ARB, Waveform Sequences
Notes	No remote command, SCPI front panel only.
Initial S/W Revision	A.05.00

### Current Segment

Specifies the selected sequence segment that will be affected by the menu functions.

Key Path	Source, Modulation Setup , ARB, Waveform Sequences, Build New Sequence
Notes	No remote command, SCPI front panel only. This key is grayed out and unavailable if the sequence is currently empty.
Initial S/W Revision	A.05.00

### Insert New Waveform

Allows you access to the sub-menu for inserting a new waveform segment or sequence. Pressing this key also changes the central display to show the Waveform File Selection View.

Key Path	Source, Modulation Setup, ARB, Waveform Sequences, Build New Sequence
Notes	No remote command, SCPI front panel only. Waveform segment name string length upper limit is 128 chars. Please do NOT insert waveform which name string exceeds 128 chars.
Initial S/W Revision	A.05.00

### Insert Waveform

Inserts the currently highlighted waveform to the end of the waveform sequence. Pressing this key also returns you to the menus for creating or editing a sequence, and returns the central view to the sequence creation view.

Key Path	Source, Modulation Setup, ARB, Waveform Sequences, Build New Sequence, Insert New Waveform
Notes	No remote command, SCPI front panel only. Waveform segment name string length upper limit is 128 chars. Please do NOT insert waveform which name string exceeds 128 chars.
Initial S/W Revision	A.05.00

### Segments on Hard Disk

Allows you access to the sub-menus for loading waveform segments from the hard disk into ARB memory. The default directory is: D: varb.

Pressing this key changes the current view to the Waveform Management View.

Key Path	Source, Modulation Setup, ARB, Select Waveform
Initial S/W Revision	A.05.00

### Load Segment To ARB Memory

Allows you to load the selected file into ARB memory. On the front panel you select the file for loading to the ARB memory by highlighting the desired file in the list. Using the SCPI command, you specify the file name on the HDD.

“NVWFM” (none-volatile storage) MSUS (Mass Storage Unit Specifier) is supported in the memory subsystem because the ARB memory cannot be accessed directly. Therefore, files must be downloaded to the instrument hard disk and then loaded into the ARB memory. “NVWFM” MSUS will be mapped to the default directory D: VARB. The SCPI command supports using either “NVWFM” MSUS or specifying a full path. For more information, see Memory Subsystem (Remote Command Only).

If a file of the same name already exists within ARB memory, it is overwritten. If you wish to load two segments of the same name, you must rename one of the segments before loading it into ARB memory. To rename a segment, you can either use Windows File Explorer, or the :MMEMory:COPI command.

NOTE: When a waveform file is loaded to ARB memory, burst timing adjustments are made automatically, based on whether or not a Multiport Adapter is connected to the test set and powered on. If the connection/power status of the Multiport Adapter is changed after a waveform file has been loaded, it needs to be loaded again.

Key Path	Source, Modulation Setup, ARB, Select Waveform, Segments on Hard Disk
Remote Command	:SOURce:RADio:ARB:LOAD <string>
Example	:SOUR:RAD:ARB:LOAD "D: VARB\testwaveform.bin" or :SOUR:RAD:ARB:LOAD "NVWFM:testwaveform.bin"
Notes	<p>Because loading the file involves a delay of unpredictable length, this command should be followed by the query *OPC?, which holds off subsequent commands until the loading operating is complete.</p> <p>&lt;string&gt; – specifies the path name of the file to load from the HDD into ARB memory. It could be a &lt;full path + filename&gt;, or &lt;"NVWFM" MSUS + colon + filename&gt;.</p> <p>When in Sequence Analyzer mode, and Include Source is Yes, an attempt to load a file to ARB memory will be rejected with an error.</p> <p>When Include Source is No and if there is insufficient free ARB memory to load the selected waveform, an error is generated. .</p> <p>If you specify a file over SCPI, but the file is not at the specified location, an error is generated.</p> <p>If you try to load a waveform file but the file contains less than 500 IQ samples, an error is generated.</p> <p>If you try to load a Signal Studio waveform "*.wfm" which contains invalid waveform header, an error is generated.</p>

If the ARB is ON when you load a file to ARB memory or delete a file from ARB memory, the playing waveform segment may not keep phase continuity during the ARB memory operation. The waveform will be replayed after the ARB operation is finished.

ARB can be loaded into ARB memory even if required licenses do not present on the instrument. In this case, a GUI only warning message -800, "Operation complete; Loaded <filename> successfully, but no license <required licenses> installed". User can install required licenses according to <required licenses> string to license it, or multi-pack license it.

Initial S/W Revision	A.05.00
----------------------	---------

### Load All To ARB Memory

Allows you to load all the segment files within the currently selected directory into ARB memory. If a file of the same name already exists within ARB memory, it is overwritten. If you wish to load two segments of the same name, you must rename one of the segments before loading it into ARB memory. To rename a segment, you can either use Windows File Explorer, or the :MEMORY:COPY command.

NOTE: When a waveform file is loaded to ARB memory, burst timing adjustments are made automatically, based on whether or not a Multiport Adapter is connected to the test set and powered on. If the connection/power status of the Multiport Adapter is changed after a waveform file has been loaded, it needs to be loaded again.

<b>Key Path</b>	Source, Modulation Setup, ARB, Select Waveform, Segments on Hard Disk
<b>Remote Command</b>	:SOURce:RADio:ARB:LOAD:ALL <string>
<b>Example</b>	:SOUR:RAD:ARB:LOAD:ALL "D: varb"
<b>Notes</b>	<p>&lt;string&gt; - specifies the directory on the HDD to load the files into ARB memory from.</p> <p>When in Sequence Analyzer mode, and Include Source is Yes, an attempt to load all files from a directory to ARB memory is rejected with an error.</p> <p>When Include Source is No and there is insufficient free ARB memory to load all the waveforms, when the ARB memory is full, the copy ceases, and an error is generated.</p> <p>If you specify a directory over SCPI, but the directory does not exist, an error is generated.</p> <p>If the ARB is ON, a user then loads or deletes file to ARB memory, the playing waveform segment may not keep phase continuity during the ARB memory operation. The waveform will be replayed after the ARB operation is finished.</p>
Initial S/W Revision	A.05.00

### Change Directory...

Allows you to change the currently selected directory on the hard disk. Pressing this key opens a standard windows change directory dialog allowing you to select the new directory of interest.

The current directory is used for manually loading waveform segments into ARB memory for playback, and as a search location for waveform segments that are required to be loaded into ARB memory for playback of a waveform sequence or a list sequence.

Key Path	Source, Modulation Setup, ARB, Select Waveform, Segments on Hard Disk
Notes	No remote command, SCPI front panel only.
Initial S/W Revision	A.05.00

#### Default Directory...

Allows you to change the default directory. It is used as a search location for waveform segments that are required to be loaded into ARB memory for playback of a waveform sequence, and as a search location for selecting waveforms using SCPI.

Key Path	Source, Modulation Setup, ARB, Select Waveform, Segments on Hard Disk
<b>Remote Command</b>	:SOURce:RADio:ARB:DEFault:DIRectory <string> :SOURce:RADio:ARB: DEFault:DIRectory?
<b>Example</b>	:SOUR:RAD:ARB:DEF:DIR "D:\ArbFiles" :SOUR:RAD:ARB:DEF:DIR?
State Saved	Persistent, survives a power cycle and a preset but not saved in the instrument state
Initial S/W Revision	A.05.00

#### Segments in ARB Memory

Allows you access to the sub-menus for managing the files within ARB memory.

Key Path	Source, Modulation Setup, ARB, Select Waveform
Initial S/W Revision	A.05.00

#### Delete Segment From ARB Mem

Allows you to remove a segment from ARB playback memory.

Key Path	Source, Modulation Setup, ARB, Select Waveform, Segments in ARB Memory
<b>Remote Command</b>	:SOURce:RADio:ARB:DELete <string>
<b>Example</b>	:SOUR:RAD:ARB:DEL "testwaveform.bin"
Notes	<string> - specifies the waveform to be deleted from the ARB playback memory. When in Sequence Analyzer mode and Include Source is Yes, an attempt to delete a file from ARB memory is rejected with an error. When Include Source is No and you specify a file that does not exist within ARB memory, an error is generated. It is possible to delete files from within the ARB memory when the ARB is ON. However, if you attempt to delete the file that is currently playing an error is generated. It is possible to delete a file from within the ARB memory when the sequencer state is ON and the file is not being used by the List Sequencer. If you attempt to delete a file which is being used by the list

sequencer, an error is generated.

When sequencer state is On, even if ARB state is On, the selected waveform will not be played. In this case, if the selected waveform is not used in List Sequence, it can be deleted and the ARB state is turned Off.

If the ARB is ON and you load a file to ARB memory or delete a file from ARB memory, the playing waveform segment may not keep phase continuity during the ARB memory operation. The waveform will be replayed after the ARB operation is finished.

---

Initial S/W Revision      A.05.00

---

### Delete All From ARB Memory

Allows you to remove all segments from ARB playback memory.

---

<b>Key Path</b>	Source, Modulation Setup, ARB, Select Waveform, Segments in ARB Memory
<b>Remote Command</b>	:SOURce:RADio:ARB:DELeTe:ALL
<b>Example</b>	:SOUR:RAD:ARB:DELeTe:ALL
<b>Notes</b>	<p>When in Sequence Analyzer mode and Include Source is Yes, an attempt to delete all files from ARB memory is rejected with an error.</p> <p>When Include Source is No and you attempt to delete all files from ARB memory when the ARB is currently playing a file, all files except the one playing are deleted and an error is generated.</p> <p>If you attempt to delete all files from ARB memory when there are waveform files used in "<a href="#">List Sequencer</a>" on page 1449 and "<a href="#">Sequencer</a>" on page 1449 state is ON, all files except the files currently being used in list sequencer are deleted, and an error is generated.</p> <p>If the ARB is ON and you load a file to ARB memory or delete a file from ARB memory, the playing waveform segment may not keep phase continuity during the ARB memory operation. The waveform will be replayed after the ARB operation is finished.</p>

---

Initial S/W Revision      A.05.00

---

### Edit Selected Waveform

Allows access to the sub-menus for editing the details of the currently selected waveform segment.

---

<b>Key Path</b>	Source, Modulation Setup, ARB, Waveform Sequences, Build New Sequence
<b>Notes</b>	No remote command, front panel only.
<b>Initial S/W Revision</b>	A.05.00

---

### Repetitions

Allows you to specify the number of times the currently selected waveform is played within the sequence.

---

<b>Key Path</b>	Source, Modulation Setup, ARB, Waveform Sequences, Build New Sequence, Edit Selected Waveform
-----------------	-----------------------------------------------------------------------------------------------

---

Notes	No remote command, SCPI front panel only.
Preset	1
Min	1
Max	65535
Initial S/W Revision	A.05.00

### Marker 1

Allows you to enable or disable marker 1 for the currently selected waveform. For a waveform sequence, you can enable and disable markers on a per-segment basis, allowing you to output markers from some waveform segments within the sequence, but not for others.

Key Path	Source, Modulation Setup, ARB, Waveform Sequences, Build New Sequence, Edit Selected Waveform
Notes	No remote command, front panel only.
Preset	Enabled
Range	Enabled Disabled
Initial S/W Revision	A.05.00

### Marker 2

Allows you to enable or disable marker 2 for the currently selected waveform. For a waveform sequence, you can enable and disable markers on a per-segment basis, allowing you to output markers from some waveform segments within the sequence, but not for others.

Key Path	Source, Modulation Setup, ARB, Waveform Sequences, Build New Sequence, Edit Selected Waveform
Notes	No remote command, front panel only.
Preset	Enabled
Range	Enabled Disabled
Initial S/W Revision	A.05.00

### Marker 3

Allows you to enable or disable marker 3 for the currently selected waveform. For a waveform sequence, you can enable and disable markers on a per-segment basis, allowing you to output markers from some waveform segments within the sequence, but not for others.

Key Path	Source, Modulation Setup, ARB, Waveform Sequences, Build New Sequence, Edit Selected Waveform
----------	-----------------------------------------------------------------------------------------------



Notes	No remote command, front panel only.
Preset	Enabled
Range	Enabled Disabled
Initial S/W Revision	A.05.00

#### Marker 4

Allows you to enable or disable marker 4 for the currently selected waveform. For a waveform sequence, you can enable and disable markers on a per-segment basis, allowing you to output markers from some waveform segments within the sequence, but not for others.

Key Path	Source, Modulation Setup, ARB, Waveform Sequences, Build New Sequence, Edit Selected Waveform
Notes	No remote command, front panel only.
Preset	Enabled
Range	Enabled Disabled
Initial S/W Revision	A.05.00

#### Delete Segment

Allows you to delete the selected segment from the waveform sequence.

Key Path	Source, Modulation Setup, ARB, Waveform Sequences, Build New Sequence
Notes	No remote command, front panel only.
Initial S/W Revision	A.05.00

#### Save Sequence...

Pressing this key displays the “Save As” dialog. The sequence name is passed to the save as dialog to use as the filename for saving, and the directory the save as dialog will open into is the default waveform directory.

Key Path	Source, Modulation Setup, ARB, Waveform Sequences, Build New Sequence
Initial S/W Revision	A.05.00

#### Edit Selected Sequence

Allows access to the sub-menus for editing the sequence currently selected within the Waveform Sequence List view. Pressing this key changes the central view area to display the Waveform Sequence Creation and Editing view.

---

Key Path	Source, Modulation Setup, ARB, Waveform Sequences
Notes	No remote command, front panel only.
Initial S/W Revision	A.05.00

---

#### Current Directory...

Allows you to change the currently selected directory on the hard disk. Pressing this key opens a standard windows change directory dialog and allows you to select the new directory of interest.

---

Key Path	Source, Modulation Setup, ARB, Waveform Sequences
Notes	No remote command, front panel only.
Initial S/W Revision	A.05.00

---

#### Waveform Utilities

Allows you access to the waveform utilities sub-menus.

---

Key Path	Source, Modulation Setup, ARB
Initial S/W Revision	A.05.00

---

#### Multi-Pack Licenses

Allows you access to the Multi - Pack License sub-menus. Pressing this key also changes the central view area to display the Multi -Pack License Management view.

On modular instrument like E6630A or E6640A, multi-pack license operations are only allowed on the default module, i.e. "Left" module for E6630A or "TRX1" module for E6640A.

---

Key Path	Source, Modulation Setup, ARB, Waveform Utilities
Dependencies	This key is only available if there is at least one Multi-pack license installed on the instrument.
Initial S/W Revision	A.05.00

---

#### Add Waveform

Pressing this key accesses the Add Waveform sub-menu. It also changes the central display area to display the Multi-Pack License Waveform Add view.

---

Key Path	Source, Modulation Setup, ARB, Waveform Utilities, Multi-Pack Licenses
Dependencies	This key is only available if there is at least one slot available within at least one multi-pack license.
Initial S/W Revision	A.05.00

---

### Add Waveform

Allows you to add the currently selected waveform segment to a multi-pack license. The new waveform is added to the next available slot regardless of which slot was selected on the Multi-Pack License Management view.

<b>Key Path</b>	Source, Modulation Setup, ARB, Waveform Utilities, Multi-Pack Licenses, Add Waveform
<b>Remote Command</b>	:SYSTem:LKEY:WAVeform:ADD <string> or :SYSTem:LIcense[:FPACK]:WAVeform:ADD <string>
<b>Example</b>	SYST:LKEY:WAV:ADD "mywaveform.wfm" or SYST:LIC:WAV:ADD "mywaveform.wfm"
<b>Notes</b>	The second SCPI :SYSTem:LIcense[:FPACK]:WAVeform:ADD is provided to be consistent with the style of Keysight signal sources. You can use either one of them. Since adding a waveform segment to a Multi-Pack license causes the license slot to enter the trial period of only 48 hours, pressing this key causes a confirmation dialog to be displayed to ensure you do want to add the waveform segment to the Multi-Pack. If you attempt to license a waveform that is already licensed using another slot an error is generated. .
<b>Dependencies</b>	This key is only available if the currently selected file is a secure waveform requiring a license, and there is at least one slot available within at least one multi-pack license. If the waveform highlighted is a secure waveform, but is already licensed, this key will be unavailable.
<b>Initial S/W Revision</b>	A.05.00

### Segments on Hard Disk

Allows you access to the sub-menus for loading waveform segments from the hard disk into ARB memory. The default directory is: D: varb.

Pressing this key changes the current view to the Waveform Management View.

<b>Key Path</b>	Source, Modulation Setup, ARB, Select Waveform
<b>Initial S/W Revision</b>	A.05.00

### Load Segment To ARB Memory

Allows you to load the selected file into ARB memory. On the front panel you select the file for loading to the ARB memory by highlighting the desired file in the list. Using the SCPI command, you specify the file name on the HDD.

"NVWFM" (none-volatile storage) MSUS (Mass Storage Unit Specifier) is supported in the memory subsystem because the ARB memory cannot be accessed directly. Therefore, files must be downloaded to the instrument hard disk and then loaded into the ARB memory. "NVWFM" MSUS will be mapped to the

default directory D: VARB. The SCPI command supports using either “NVWFM” MSUS or specifying a full path. For more information, see Memory Subsystem (Remote Command Only).

If a file of the same name already exists within ARB memory, it is overwritten. If you wish to load two segments of the same name, you must rename one of the segments before loading it into ARB memory. To rename a segment, you can either use Windows File Explorer, or the :MMEMory:COPI command.

NOTE: When a waveform file is loaded to ARB memory, burst timing adjustments are made automatically, based on whether or not a Multiport Adapter is connected to the test set and powered on. If the connection/power status of the Multiport Adapter is changed after a waveform file has been loaded, it needs to be loaded again.

<b>Key Path</b>	Source, Modulation Setup, ARB, Select Waveform, Segments on Hard Disk
<b>Remote Command</b>	:SOURce:RADio:ARB:LOAD <string>
<b>Example</b>	:SOUR:RAD:ARB:LOAD "D: VARB\testwaveform.bin" or :SOUR:RAD:ARB:LOAD "NVWFM:testwaveform.bin"
<b>Notes</b>	<p>Because loading the file involves a delay of unpredictable length, this command should be followed by the query *OPC?, which holds off subsequent commands until the loading operating is complete.</p> <p>&lt;string&gt; – specifies the path name of the file to load from the HDD into ARB memory. It could be a &lt;full path + filename&gt;, or &lt;“NVWFM” MSUS + colon + filename&gt;.</p> <p>When in Sequence Analyzer mode, and Include Source is Yes, an attempt to load a file to ARB memory will be rejected with an error.</p> <p>When Include Source is No and if there is insufficient free ARB memory to load the selected waveform, an error is generated. .</p> <p>If you specify a file over SCPI, but the file is not at the specified location, an error is generated.</p> <p>If you try to load a waveform file but the file contains less than 500 IQ samples, an error is generated.</p> <p>If you try to load a Signal Studio waveform “*.wfm” which contains invalid waveform header, an error is generated.</p> <p>If the ARB is ON when you load a file to ARB memory or delete a file from ARB memory, the playing waveform segment may not keep phase continuity during the ARB memory operation. The waveform will be replayed after the ARB operation is finished.</p> <p>ARB can be loaded into ARB memory even required licenses do not present on the instrument. In this case, a GUI only warning message –800, “Operation complete; Loaded &lt;filename&gt; successfully, but no license &lt;required licenses&gt; installed”. User can install required licenses according to &lt;required licenses&gt; string to license it, or multi-pack license it.</p>
<b>Initial S/W Revision</b>	A.05.00

### Load All To ARB Memory

Allows you to load all the segment files within the currently selected directory into ARB memory. If a file of the same name already exists within ARB memory, it is overwritten. If you wish to load two segments of the same name, you must rename one of the segments before loading it into ARB memory. To rename a segment, you can either use Windows File Explorer, or the :MEMory:COPI command.

NOTE: When a waveform file is loaded to ARB memory, burst timing adjustments are made automatically, based on whether or not a Multiport Adapter is connected to the test set and powered on. If the

connection/power status of the Multiport Adapter is changed after a waveform file has been loaded, it needs to be loaded again.

Key Path	Source, Modulation Setup, ARB, Select Waveform, Segments on Hard Disk
Remote Command	:SOURce:RADio:ARB:LOAD:ALL <string>
Example	:SOUR:RAD:ARB:LOAD:ALL "D: varb"
Notes	<p>&lt;string&gt; - specifies the directory on the HDD to load the files into ARB memory from.</p> <p>When in Sequence Analyzer mode, and Include Source is Yes, an attempt to load all files from a directory to ARB memory is rejected with an error.</p> <p>When Include Source is No and there is insufficient free ARB memory to load all the waveforms, when the ARB memory is full, the copy ceases, and an error is generated.</p> <p>If you specify a directory over SCPI, but the directory does not exist, an error is generated.</p> <p>If the ARB is ON, a user then loads or deletes file to ARB memory, the playing waveform segment may not keep phase continuity during the ARB memory operation. The waveform will be replayed after the ARB operation is finished.</p>
Initial S/W Revision	A.05.00

#### Change Directory...

Allows you to change the currently selected directory on the hard disk. Pressing this key opens a standard windows change directory dialog allowing you to select the new directory of interest.

The current directory is used for manually loading waveform segments into ARB memory for playback, and as a search location for waveform segments that are required to be loaded into ARB memory for playback of a waveform sequence or a list sequence.

Key Path	Source, Modulation Setup, ARB, Select Waveform, Segments on Hard Disk
Notes	No remote command, SCPIfront panel only.
Initial S/W Revision	A.05.00

#### Default Directory...

Allows you to change the default directory. It is used as a search location for waveform segments that are required to be loaded into ARB memory for playback of a waveform sequence, and as a search location for selecting waveforms using SCPI.

Key Path	Source, Modulation Setup, ARB, Select Waveform, Segments on Hard Disk
Remote Command	:SOURce:RADio:ARB:DEFault:DIRectory <string> :SOURce:RADio:ARB: DEFault:DIRectory?
Example	:SOUR:RAD:ARB:DEF:DIR "D:\ArbFiles" :SOUR:RAD:ARB:DEF:DIR?
State Saved	Persistent, survives a power cycle and a preset but not saved in the instrument state
Initial S/W Revision	A.05.00

### Replace Waveform

Pressing this key accesses the Replace Waveform submenu. It also changes the central display area to display the Multi-Pack License Waveform Add view.

Key Path	Source, Modulation Setup, ARB, Waveform Utilities, Multi-Pack Licenses
Dependencies	This key is only available if the currently selected slot is in the trial state.
Initial S/W Revision	A.05.00

### Replace Waveform

Allows you to replace the waveform in the currently selected slot with the waveform currently selected in the Multi-Pack License Waveform Add view.

Key Path	Source, Modulation Setup, ARB, Waveform Utilities, Multi-Pack Licenses, Replace Waveform
Remote Command	:SYSTem:LKEY:WAVeform:REPLace <int>, <string> or :SYSTem:LICense[:FPACK]:WAVeform:REPLace <int>, <string>
Example	SYST:LKEY:WAV:REPL 1, "myotherwaveform.wfm" or :SYST:LIC:WAV:REPL 1, "myotherwaveform.wfm"
Notes	The second SCPI :SYSTem:LICense[:FPACK]:WAVeform:REPLace is provided to be consistent with the style of Keysight signal sources. You can use either one of them. If you attempt to license a waveform that is already licensed using another slot an error is generated. Waveform slot number <int> is positive. If you attempt to input a slot number less than or equals 0, an error is generated.
Initial S/W Revision	A.05.00

### Clear Waveform from Slot

Allows you to clear the waveform from the selected slot.

Key Path	Source, Modulation Setup, ARB, Waveform Utilities, Multi-Pack Licenses
Remote Command	:SYSTem:LKEY:WAVeform:CLEar <int> or :SYSTem:LICense[:FPACK]:WAVeform:CLEar <int>
Example	SYST:LKEY:WAV:CLE 1 or :SYST:LIC:WAV:CLE 1
Notes	The second SCPI :SYSTem:LICense[:FPACK]:WAVeform:CLEar is provided to be consistent with the style of Keysight signal sources. You can use either one of them. Waveform slot number <int> is positive. If you attempt to input a slot number less than or equals 0, an error is generated.

error is generated.

Dependencies	This key is only available if the currently selected slot is in the trial state.
Initial S/W Revision	A.05.00

### Lock Waveform in Slot

If the selected slot is in the trial state or the lock required state, the waveform that occupies the slot is locked and permanently licensed.

Key Path	Source, Modulation Setup, ARB, Waveform Utilities, Multi-Pack Licenses
Remote Command	:SYSTem:LKEY:WAVeform:LOCK <int> or :SYSTem:LICense[:FPACK]:WAVeform:LOCK <int>
Example	SYST:LKEY:WAV:LOCK 1 or SYST:LIC:WAV:LOCK 1
Notes	The second SCPI :SYSTem:LICense[:FPACK]:WAVeform:LOCK is provided to be consistent with the style of Keysight signal sources. You can use either one of them. Waveform slot number <int> is positive. If you attempt to input a slot number less than or equals 0, an error is generated.
Dependencies	This key is only available if the currently selected slot is in the trial state or the lock required state.
Initial S/W Revision	A.05.00

### Marker Utilities

Allows access to the marker utilities sub-menus.

Key Path	Source, Modulation Setup, ARB
Initial S/W Revision	A.05.00

### Marker Polarity

Allows access to the marker polarity sub-menu, which allows you to specify the polarity for the four markers. For a positive polarity, the marker signal is high during the marker points. For a negative marker polarity, the marker signal is high during the period of no marker points.

Key Path	Source, Modulation Setup, ARB, Marker Utilities
Initial S/W Revision	A.05.00

### Mkr 1 Polarity

Allows you to set the polarity of marker 1.

<b>Key Path</b>	Source, Modulation Setup, ARB, Marker Utilities, Marker Polarity
<b>Remote Command</b>	:SOURce:RADio:ARB:MPOLarity:MARKer1 POSitive NEGative :SOURce:RADio:ARB:MPOLarity:MARKer1?
<b>Example</b>	:SOUR:RAD:ARB:MPOL:MARK1 NEG
<b>Dependencies</b>	When a new waveform is selected for playback the settings contained within the associated waveform header file are applied to the ARB. The marker polarity is one of the values stored within the header file. If the newly selected waveform file has an associated header file, the marker polarity is updated with the value from the header file. The marker polarity will remain unchanged if the newly selected waveform does not have an associated header file.
<b>Preset</b>	Pos
<b>Range</b>	Neg   Pos
<b>Initial S/W Revision</b>	A.05.00

### Mkr 2 Polarity

Allows you to set the polarity of marker 2.

<b>Key Path</b>	Source, Modulation Setup, ARB, Marker Utilities, Marker Polarity
<b>Remote Command</b>	:SOURce:RADio:ARB:MPOLarity:MARKer2 POSitive NEGative :SOURce:RADio:ARB:MPOLarity:MARKer2?
<b>Example</b>	:SOUR:RAD:ARB:MPOL:MARK2 NEG
<b>Dependencies</b>	When a new waveform is selected for playback the settings contained within the associated waveform header file are applied to the ARB. The marker polarity is one of the values stored within the header file. If the newly selected waveform file has an associated header file, the marker polarity is updated with the value from the header file. The marker polarity will remain unchanged if the newly selected waveform does not have an associated header file.
<b>Preset</b>	Pos
<b>Range</b>	Neg   Pos
<b>Initial S/W Revision</b>	A.05.00

### Mkr 3 Polarity

Allows you to set the polarity of marker 3.

<b>Key Path</b>	Source, Modulation Setup, ARB, Marker Utilities, Marker Polarity
<b>Remote Command</b>	:SOURce:RADio:ARB:MPOLarity:MARKer3 POSitive NEGative :SOURce:RADio:ARB:MPOLarity:MARKer3?
<b>Example</b>	:SOUR:RAD:ARB:MPOL:MARK3 NEG
<b>Dependencies</b>	When a new waveform is selected for playback the settings contained within the associated



	waveform header file are applied to the ARB. The marker polarity is one of the values stored within the header file. If the newly selected waveform file has an associated header file, the marker polarity is updated with the value from the header file. The marker polarity will remain unchanged if the newly selected waveform does not have an associated header file.
Preset	Pos
Range	Neg   Pos
Initial S/W Revision	A.05.00

### Mkr 4 Polarity

Allows you to set the polarity of marker 4.

Key Path	Source, Modulation Setup, ARB, Marker Utilities, Marker Polarity
Remote Command	:SOURce:RADio:ARB:MPOLarity:MARKer4 POSitive NEGative :SOURce:RADio:ARB:MPOLarity:MARKer4?
Example	:SOUR:RAD:ARB:MPOL:MARK4 NEG
Dependencies	When a new waveform is selected for playback the settings contained within the associated waveform header file are applied to the ARB. The marker polarity is one of the values stored within the header file. If the newly selected waveform file has an associated header file, the marker polarity is updated with the value from the header file. The marker polarity will remain unchanged if the newly selected waveform does not have an associated header file.
Preset	Pos
Range	Neg   Pos
Initial S/W Revision	A.05.00

### Marker Routing

Allows access to the marker routing sub-menus, which allow you to specify where the marker events are routed. It should be noted that the markers can also be routed to Trigger 1 Out and Trigger 2 Out, however this must be set up using the menus accessed by pressing the “Trigger” hard key.

Key Path	Source, Modulation Setup, ARB, Marker Utilities
Initial S/W Revision	A.05.00

### Pulse/RF Blank

Allows you to select which marker is used for the pulse/RF blanking function. The pulse/RF blanking function blanks the RF when the marker signal goes low. The marker polarity determines when the marker signal is high. For a positive polarity, this is during the marker points. For a negative polarity, this is when there are no marker points.

Marker points should be set before using this function. Enabling this function without setting maker points may create a continuous low or high signal, dependant on the marker polarity. This causes either no RF output, or a continuous RF output.

<b>Key Path</b>	Source, Modulation Setup, ARB, Marker Utilities, Marker Routing
<b>Remote Command</b>	:SOURce:RADio:ARB:MDEStination:PULSe NONE   M1   M2   M3   M4 :SOURce:RADio:ARB:MDEStination:PULSe?
<b>Example</b>	:SOUR:RAD:ARB:MDES:PULS NONE
<b>Dependencies</b>	When a new waveform is selected for playback the settings contained within the associated waveform header file are applied to the ARB. The pulse/RF blanking setting is one of the values stored within the header file. If the newly selected waveform file has an associated header file, the pulse/RF blanking setting is updated with the value from the header file. The pulse/RF blanking setting will remain unchanged if the newly selected waveform does not have an associated header file.
<b>Range</b>	None   M1   M2   M3   M4
<b>Initial S/W Revision</b>	A.05.00

#### None

Sets no marker to be used for the pulse/RF blanking function, essentially turning the RF blanking function off.

<b>Key Path</b>	Source, Modulation Setup, ARB, Marker Utilities, Marker Routing, Pulse/RF Blank
<b>Example</b>	:SOUR:RAD:ARB:MDES:PULS NONE
<b>Initial S/W Revision</b>	A.05.00

#### Marker 1

Sets marker 1 to be used for the pulse/RF blanking function.

<b>Key Path</b>	Source, Modulation Setup, ARB, Marker Utilities, Marker Routing, Pulse/RF Blank
<b>Example</b>	:SOUR:RAD:ARB:MDES:PULS M1
<b>Initial S/W Revision</b>	A.05.00

#### Marker 2

Sets marker 2 to be used for the pulse/RF blanking function.

<b>Key Path</b>	Source, Modulation Setup, ARB, Marker Utilities, Marker Routing, Pulse/RF Blank
<b>Example</b>	:SOUR:RAD:ARB:MDES:PULS M2
<b>Initial S/W Revision</b>	A.05.00

### Marker 3

Sets marker 3 to be used for the pulse/RF blanking function.

Key Path	Source, Modulation Setup, ARB, Marker Utilities, Marker Routing, Pulse/RF Blank
<b>Example</b>	:SOUR:RAD:ARB:MDES:PULS M3
Initial S/W Revision	A.05.00

### Marker 4

Sets marker 4 to be used for the pulse/RF blanking function.

Key Path	Source, Modulation Setup, ARB, Marker Utilities, Marker Routing, Pulse/RF Blank
<b>Example</b>	:SOUR:RAD:ARB:MDES:PULS M4
Initial S/W Revision	A.05.00

### ALC Hold

Allows you to specify which marker is routed for use within the ALC hold function. The ALC hold marker function holds the ALC circuitry at the average value of the sample points set by the marker.

The ALC hold function operates during the low periods of the marker signal. The marker polarity determines when the marker signal is high. For positive polarity, this is during the marker points. For a negative polarity, this is when there are no marker points.

Key Path	Source, Modulation Setup, ARB, Marker Utilities, Marker Routing
<b>Remote Command</b>	:SOURce:RADio:ARB:MDEStination:ALCHold NONE M1 M2 M3 M4 :SOURce:RADio:ARB:MDEStination:ALCHold?
<b>Example</b>	:SOUR:RAD:ARB:MDES:ALCH NONE
Dependencies	When a new waveform is selected for playback the settings contained within the associated waveform header file are applied to the ARB. The ALC hold setting is one of the values stored within the header file. If the newly selected waveform file has an associated header file, the ALC hold setting is updated with the value from the header file. The ALC hold setting will remain unchanged if the newly selected waveform does not have an associated header file.
Range	None   M1   M2   M3   M4
Initial S/W Revision	A.05.00

### None

Sets no marker to be used for the ALC hold function, essentially turning the ALC hold function off.

Key Path	Source, Modulation Setup, ARB, Marker Utilities, Marker Routing, ALC Hold
<b>Example</b>	:SOUR:RAD:ARB:MDES:PULS NONE
Initial S/W Revision	A.05.00

### Marker 1

Sets marker 1 to be used for the ALC hold function.

Key Path	Source, Modulation Setup, ARB, Marker Utilities, Marker Routing, ALC Hold
<b>Example</b>	:SOUR:RAD:ARB:MDES:PULS M1
Initial S/W Revision	A.05.00

### Marker 2

Sets marker 2 to be used for the ALC hold function.

Key Path	Source, Modulation Setup, ARB, Marker Utilities, Marker Routing, ALC Hold
<b>Example</b>	:SOUR:RAD:ARB:MDES:PULS M2
Initial S/W Revision	A.05.00

### Marker 3

Sets marker 3 to be used for the ALC hold function.

Key Path	Source, Modulation Setup, ARB, Marker Utilities, Marker Routing, ALC Hold
<b>Example</b>	:SOUR:RAD:ARB:MDES:PULS M3
Initial S/W Revision	A.05.00

### Marker 4

Sets marker 4 to be used for the ALC hold function.

Key Path	Source, Modulation Setup, ARB, Marker Utilities, Marker Routing, ALC Hold
<b>Example</b>	:SOUR:RAD:ARB:MDES:PULS M4
Initial S/W Revision	A.05.00

### Header Utilities

Allows access to the header utilities sub-menu. Pressing this key also causes the central display area to change to display the File Header Information view.

Key Path	Source, Modulation Setup, ARB
Dependencies	This key is only available if there is currently a waveform selected for playback. If no waveform is selected, the key is grayed out.
Initial S/W Revision	A.05.00

### Clear Header

Allows you to clear the header information from the file header associated with the currently selected waveform.

<b>Key Path</b>	Source, Modulation Setup, ARB, Header Utilities
<b>Remote Command</b>	:SOURce:RADio:ARB:HEADer:CLEar
<b>Example</b>	:SOUR:RAD:ARB:HEAD:CLE
<b>Notes</b>	Attempting to clear the header details via SCPI when no waveform was selected for playback will generate an error.
<b>Initial S/W Revision</b>	A.05.00

### Save Setup To Header

Allows you to save new file header information details to the file.

<b>Key Path</b>	Source, Modulation Setup, ARB, Header Utilities
<b>Remote Command</b>	:SOURce:RADio:ARB:HEADer:SAVE
<b>Example</b>	:SOUR:RAD:ARB:HEAD:SAVE
<b>Notes</b>	Attempting to save the header details via SCPI when no waveform was selected for playback will generate an error.
<b>Initial S/W Revision</b>	A.05.00

### AM

Allows access to the menu for configuring the Amplitude Modulation.

<b>Key Path</b>	Source, Modulation Setup
<b>Initial S/W Revision</b>	A.05.00

### AM

Enables or disables the amplitude modulation.

Turning AM on when another modulation format is already on results in the previous modulation format being turned off and the generation of an error.

<b>Key Path</b>	Source, Modulation Setup, AM
<b>Remote Command</b>	:SOURce:AM:STATe :SOURce:AM:STATe?
<b>Example</b>	:SOUR:AM:STAT OFF

Preset	Off
Range	On   Off
Initial S/W Revision	A.05.00

### AM Depth

Allows you to set the amplitude modulation depth in percent.

Key Path	Source, Modulation Setup, AM
<b>Remote Command</b>	:SOURce:AM[:DEPTh] [:LINear] :SOURce:AM[:DEPTh] [:LINear]?
<b>Example</b>	:SOUR:AM 0.1
Preset	0.1 %
Min	0.1 %
Max	95.0 %
Initial S/W Revision	A.05.00

### AM Rate

Allows you to set the internal amplitude modulation rate.

Key Path	Source, Modulation Setup, AM
<b>Remote Command</b>	:SOURce:AM:INTernal:FREQuency :SOURce:AM:INTernal:FREQuency?
<b>Example</b>	:SOUR:AM:INT:FREQ 40.0 Hz
Preset	400.0 Hz
Min	10 Hz
Max	40 kHz
Initial S/W Revision	A.05.00

### FM

Allows access to the menu for configuring the frequency modulation.

Key Path	Source, Modulation Setup
Initial S/W Revision	A.05.00

## FM

Enables or disables the frequency modulation.

Turning FM on when another modulation format is already on results in the previous modulation format being turned off and the generation of an error.

Key Path	Source, Modulation Setup, FM
<b>Remote Command</b>	:SOURce:FM:STATe :SOURce:FM:STATe?
<b>Example</b>	:SOUR:FM:STAT OFF
Preset	Off
Range	On   Off
Initial S/W Revision	A.05.00

## FM Deviation

Allows you to set the frequency modulation deviation.

Key Path	Source, Modulation Setup, FM
<b>Remote Command</b>	:SOURce:FM[:DEVIation] :SOURce:FM[:DEVIation]?
<b>Example</b>	:SOUR:FM 1.00 kHz
Preset	1.00 Hz
Min	1.00 Hz
Max	100.00 kHz
Initial S/W Revision	A.05.00

## FM Rate

Allows you to set the internal frequency modulation rate.

Key Path	Source, Modulation Setup, FM
<b>Remote Command</b>	:SOURce:FM:INTernal:FREQuency :SOURce:FM:INTernal:FREQuency?
<b>Example</b>	:SOUR:FM:INT:FREQ 40.0 Hz
Preset	400.0 Hz
Min	10 Hz
Max	40 kHz
Initial S/W Revision	A.05.00

## PM

Allows access to the menu for configuring the phase modulation.

Key Path	Source, Modulation Setup
Initial S/W Revision	A.05.00

## PM

Enables or disables the phase modulation.

Turning PM on when another modulation format is already on results in the previous modulation format being turned off and the generation of an error.

Key Path	Source, Modulation Setup, PM
<b>Remote Command</b>	:SOURce:PM:STATe :SOURce:PM:STATe?
<b>Example</b>	:SOUR:PM:STAT OFF
Preset	Off
Range	On   Off
Initial S/W Revision	A.05.00

## PM Deviation

Allows you to set the phase modulation deviation.

Key Path	Source, Modulation Setup, PM
<b>Remote Command</b>	:SOURce:PM[:DEViation] :SOURce:PM[:DEViation]?
<b>Example</b>	:SOUR:PM 1.00 rad
Preset	0.1 rad
Min	0.1 rad
Max	20.0 rad
Initial S/W Revision	A.05.00

## PM Rate

Allows you to set the internal phase modulation rate.

Key Path	Source, Modulation Setup, PM
<b>Remote Command</b>	:SOURce:PM:INTernal:FREQuency :SOURce:PM:INTernal:FREQuency?



<b>Example</b>	:SOUR:PM:INT:FREQ 40.0 Hz
Preset	400.0 Hz
Min	10 Hz
Max	40 kHz
Initial S/W Revision	A.05.00

## List Sequencer

Allows you access to the sub-menus for configuring the list sequencer.

List sequences allows you to enter frequencies and amplitudes at unequal intervals in nonlinear ascending, descending or random order. Each step within the list can also include its own waveform file for playback, step duration, trigger event and trigger output.

The complexities involved in configuring the list sequencer do not lend itself to manual configuration; hence the manual configuration for this feature is limited. For easier configuration of the list sequencer, it is recommended that you use either SCPI or load a tab delimited file containing the setup parameters in a tabular form. The details of the SCPI for configuring the list sequencer can be found in Step Configuration (Remote Command Only).

Once the List Sequencer has been configured using the front panel, SCPI, or loading in a tab delimited file, the sequence must be initiated using the front panel Initiate Sequence key or the corresponding SCPI command.

<b>Key Path</b>	<b>Source</b>
Initial S/W Revision	A.05.00

## Sequencer

Allows you to set the state of the list sequencer. When the list sequencer is on, the source is outputting the sequence defined by the sequencer. When the list sequencer is off, the source outputs a single waveform segment or sequence (independent mode) at a single frequency and amplitude.

<b>Key Path</b>	<b>Source, List Sequencer</b>
<b>Remote Command</b>	:SOURce:LIST[:STATe] ON OFF 1 0 :SOURce:LIST[:STATe]?
<b>Example</b>	:SOUR:LIST OFF
<b>Notes</b>	When the sequencer is set to ON, the list sequencer controls the output of the source.
<b>Couplings</b>	When in Sequence Analyzer mode and the list sequencer state is Off, Include Source is forced to No, and the Include Source key is grayed out. When in Sequence Analyzer mode and the list sequencer state is On, Include Source is available to set. And, an ARB memory related operation, like load or delete will be rejected.

Preset	Off
Range	On   Off
Initial S/W Revision	A.05.00

## Initiate Sequence

Pressing this key arms the sequence for single execution. Once the sequence is armed the source begins the sequence as soon as the trigger is received. If the trigger is set to Free Run, the sequence starts immediately.

Key Path	Source, List Sequencer
<b>Remote Command</b>	:SOURce:LIST:TRIGger [:IMMediate]
<b>Example</b>	:SOUR:LIST:TRIG
Notes	<p>When in Sequence Analyzer mode and Include Source is Yes, the Initiate list sequencer operation is rejected, and the key is grayed out, since source list sequence request is sent to physics via Parallel batch by sequence analyzer.</p> <p>If the file needed by the sequencer is not already in ARB memory, the sequence cannot be initiated and an error will be generated.</p> <p>There is a blocking SCPI query which can be used to query if source list sequence being initiated successfully or not. (see Query List Sequence Initiation Armed Status (Remote Command Only) Query Source List Sequence Armed Status)</p>
Dependencies	Under the Sequence Analyzer Mode, if Meas Setup->Include Source is set to YES, Source->List Sequencer->Initiate Sequence is disabled.
Initial S/W Revision	A.05.00

## List Sequencer Setup

Allows you access to the list sequencer setup menus.

Key Path	Source, List Sequencer
----------	------------------------

### Number of Steps

Allows you to specify the number of steps within the list sequence.

Key Path	Source, List Sequencer, List Sequencer Setup
<b>Remote Command</b>	:SOURce:LIST:NUMBer:STEPs <integer> :SOURce:LIST:NUMBer:STEPs?
<b>Example</b>	:SOUR:LIST:NUMB:STEP 1
Notes	Increasing the number of steps creates additional steps at the end of the list, with all the settings

	within the steps set to their default values. Decreasing the number of steps removes steps from the end of the list. The settings within the removed steps are not reset. This means that increasing the number of steps again would allow you to retrieve these steps.
Dependencies	The Step Count parameter is increased or decreased when you insert or delete a point from within the GUI interface to the sequencer.
Preset	1
Min	1
Max	1000
Initial S/W Revision	A.05.00

### Current Step

Allows you to select the step number you wish to view or edit.

Key Path	Source, List Sequencer, List Sequencer Setup
Notes	No remote command, front panel only.
Preset	1
Min	1
Max	Step Count
Initial S/W Revision	A.05.00

### Insert Step Before

Allows you to insert a new step, containing default values, before the currently selected step. Inserting a step will automatically increase the Step Count parameter by 1. If sequence already reaches upper limit of 1000 steps, then insert more step will be rejected and popup error -221, "Setting Conflict; Cannot insert more steps, maximum number of steps reached"

Key Path	Source, List Sequencer, List Sequencer Setup
Notes	No remote command, front panel only. If the list already contains the maximum limit of 1000 steps, no operation will be made after pressing this key.
Initial S/W Revision	A.05.00

### Delete Step

Allows you to delete the current step. Deleting a step will automatically decrease the Step Count parameter by 1. If sequence only has one step left, delete step will be rejected and popup error -221, "Setting conflict; Cannot delete current step, minimum number of steps reached"

Key Path	Source, List Sequencer, List Sequencer Setup
Notes	No remote command, Front Panel key only. If the list already contains the minimum limit of 1 step, no operation will be made after pressing this key
Initial S/W Revision	A.05.00

### Clear List

Allows you to clear the list. Clearing the list sets the number of steps to the default value of 1 and sets the parameters for the only step to their default values.

Key Path	Source, List Sequencer, List Sequencer Setup
Initial S/W Revision	A.05.00

### Step Trigger

Allows access to the sub-menu for selecting the trigger input for the current step.

Key Path	Source, List Sequencer, List Sequencer Setup
Remote Command	:SOURCE:LIST:STEP[1] 2 3...1000:SETup:INPut:TRIGger IMMEDIATE   INTERNAL   EXTERNAL2   KEY   BUS   EXTERNAL4  :SOURCE:LIST:STEP[1] 2 3...1000:SETup:INPut:TRIGger?
Example	:SOUR:LIST:STEP2:SET:INP:TRIG BUS :SOUR:LIST:STEP2:SET:INP:TRIG?
Notes	SCPI is supported after A.09.40
Preset	Free Run
Range	Free Run   Internal   Manual (Trigger Key)   Bus   External 2   EXTERNAL4
Initial S/W Revision	A.05.00

### Free Run

Sets the trigger input for the current step to Free Run.

Key Path	Source, List Sequencer, List Sequencer Setup, Step Trigger
Example	:SOUR:LIST:STEP2:SET:INP:TRIG IMM
Notes	SCPI is supported after A.09.40
Initial S/W Revision	A.05.00

### Internal

Sets the trigger input for the current step to Internal.

Key Path	Source, List Sequencer, List Sequencer Setup, Step Trigger
<b>Example</b>	:SOUR:LIST:STEP2:SET:INP:TRIG INT
Notes	SCPI is supported after A.09.40
Initial S/W Revision	A.05.00

### Manual (Trigger Key)

Sets the trigger input for the current step to Manual (Trigger Key). Any step in the sequence set to Manual will cause the sequence execution to stop until the manual trigger key is pressed. Sending the Bus Trigger SCPI command will have no effect. At any point in the sequence where the list sequencer is paused waiting for a software trigger, a pop up dialog is displayed until the trigger event occurs.

Key Path	Source, List Sequencer, List Sequencer Setup, Step Trigger
<b>Example</b>	:SOUR:LIST:STEP2:SET:INP:TRIG KEY
Notes	SCPI is supported after A.09.40
Initial S/W Revision	A.05.00

### Bus

Sets the trigger input for the current step to Bus. Any step in the sequence set to Bus will cause the sequence execution to stop until the Bus Trigger SCPI command is sent. Pressing the manual trigger key has no effect. At any point in the sequence where the list sequencer is paused waiting for a software trigger, a pop up dialog is displayed until the trigger event occurs.

Key Path	Source, List Sequencer, List Sequencer Setup, Step Trigger
<b>Example</b>	:SOUR:LIST:STEP2:SET:INP:TRIG BUS
Notes	SCPI is supported after A.09.40
Initial S/W Revision	A.05.00

### External 2

Sets the trigger input for the current step to External 2.

Key Path	Source, List Sequencer, List Sequencer Setup, Step Trigger
<b>Example</b>	:SOUR:LIST:STEP2:SET:INP:TRIG EXT2
Notes	SCPI is supported after A.09.40
Notes	Note: When on E6640A, trigger 2 is a bi-directional trigger port. So when trigger 2 has been configured as OUTPUT type, choosing External 2 as the input trigger for the current step will generate error.
Initial S/W Revision	A.05.00

## Transition Time

Allows you to specify the transition time for the current step.

The transition time is the amount of time allowed for the source to settle at the current frequency or amplitude value.

Transition Time should not be taken as additional time before or inside the Step Duration. You can set a value for the settling time to allow the source output frequency or amplitude to become stable. Make sure that during this period of time, you do not use the source output signal.

The following table lists recommended values for appropriate settling times to allow for changes within the source.

Value Changed	Recommended Transition Time
Frequency	500 $\mu$ s
Amplitude	100 $\mu$ s to within 0.1 dB 20 $\mu$ s to within 1.0 dB

If the Transition Time value is shorter than the time necessary for the hardware to settle and a List Sequence is initiated, a **warning** is generated.

If the Transition Time value is longer than the Step Duration, an error is generated when initiating a source list sequence. For source list sequence, transition time is included in the step duration length. If the Transition Time value is longer than the Step Duration Time, the real step duration length is extended to equal the transition time and cause a timing shift.

Key Path	Source, List Sequencer, List Sequencer Setup
Remote Command	:SOURce:LIST:STEP[1] 2 3...1000:SETup:TRANSition:TIME <time> :SOURce:LIST:STEP[1] 2 3...1000:SETup:TRANSition:TIME?
Example	:SOUR:LIST:STEP2:SET:TRAN:TIME 1ms :SOUR:LIST:STEP2:SET:TRAN:TIME?
Notes	SCPI is supported after A.09.40
Preset	1.0 ms
Min	0.0 ms
Max	4.0 ks
Initial S/W Revision	A.05.00

## Radio Setup

Allows you access to the sub-menus for setting up the radio standard, band, and radio band link direction for the current step.

Key Path	Source, List Sequencer, List Sequencer Setup
Notes	No remote command, front panel only.

---

Initial S/W Revision	A.05.00
----------------------	---------

---

### Radio Standard

Allows access to the sub-menus for selecting the radio standard and the associated radio band for use in the current step.

<b>Key Path</b>	Source, List Sequencer, List Sequencer Setup, Radio Setup
<b>Remote Command</b>	:SOURCE:LIST:STEP[1] 2 3...1000:SETup:RADio:BAND NONE   PGSM   EGSM   RGSM   DCS1800   PCS1900   TGSM810   GSM450   GSM480   GSM700   GSM850   BANDI   BANDII   BANDIII   BANDIV   BANDV   BANDVI   BANDVII   BANDVIII   BANDIX   BANDX   BANDXI   BANDXII   BANDXIII   BANDXIV   BANDXIX   USCELL   USPCS   JAPAN   KOREAN   NMT   IMT2K   UPPER   SECOND   PAMR400   PAMR800   IMTEXT   PCS1DOT9G   AWS   US2DOT5G   PUBLIC   LOWER   NONE   BAND1   BAND2   BAND3   BAND4   BAND5   BAND6   BAND7   BAND8   BAND10   BAND11   BAND12   BAND13   BAND14   BAND17   BAND18   BAND19   BAND20   BAND21   BAND24   BAND25   BAND26   BAND27   BAND28   BAND29   BAND30   BAND31   BAND33   BAND34   BAND35   BAND36   BAND37   BAND38   BAND39   BAND40   BAND41   BAND42   BAND43   BAND44   BANDA   BANDB   BANDC   BANDD   BANDE   BANDF  :SOURCE:LIST:STEP[1] 2 3...1000:SETup: RADio:BAND?
<b>Example</b>	:SOUR:LIST:STEP2:SET:RAD:BAND PGSM :SOUR:LIST:STEP2:SET:RAD:BAND?
<b>Notes</b>	SCPI is supported after A.09.40
Initial S/W Revision	A.05.00

### None

Selects no radio standard for use on the current step.

<b>Key Path</b>	Source, List Sequencer, List Sequencer Setup, Radio Setup, Radio Standard
<b>Example</b>	:SOUR:LIST:STEP2:SET:RAD:BAND NONE
<b>Notes</b>	SCPI is supported after A.09.40
Initial S/W Revision	A.05.00

### GSM/EDGE

Pressing this key once selects GSM/EDGE as the radio standard and the current GSM/EDGE band as the active channel band. Pressing this key again allows access to the sub-menus for selecting a different GSM/EDGE band.

<b>Key Path</b>	Source, List Sequencer, List Sequencer Setup, Radio Setup, Radio Standard
Initial S/W Revision	A.05.00

### P-GSM

Selects P-GSM as the band for the current step.

Key Path	Source, List Sequencer, List Sequencer Setup, Radio Setup, Radio Standard, GSM/EDGE
Initial S/W Revision	A.05.00

### E-GSM

Selects E-GSM as the band for the current step.

Key Path	Source, List Sequencer, List Sequencer Setup, Radio Setup, Radio Standard, GSM/EDGE
Initial S/W Revision	A.05.00

### R-GSM

Selects R-GSM as the band for the current step.

Key Path	Source, List Sequencer, List Sequencer Setup, Radio Setup, Radio Standard, GSM/EDGE
Initial S/W Revision	A.05.00

### DCS 1800

Selects DCS 1800 as the band for the current step.

Key Path	Source, List Sequencer, List Sequencer Setup, Radio Setup, Radio Standard, GSM/EDGE
Initial S/W Revision	A.05.00

### PCS 1900

Selects PCS 1900 as the band for the current step.

Key Path	Source, List Sequencer, List Sequencer Setup, Radio Setup, Radio Standard, GSM/EDGE
Initial S/W Revision	A.05.00

### GSM 450

Selects GSM 450 as the band for the current step.

Key Path	Source, List Sequencer, List Sequencer Setup, Radio Setup, Radio Standard, GSM/EDGE
Initial S/W Revision	A.05.00



### GSM 480

Selects GSM 480 as the band for the current step.

Key Path	Source, List Sequencer, List Sequencer Setup, Radio Setup, Radio Standard, GSM/EDGE
Initial S/W Revision	A.05.00

### GSM 850

Selects GSM 850 as the band for the current step.

Key Path	Source, List Sequencer, List Sequencer Setup, Radio Setup, Radio Standard, GSM/EDGE
Initial S/W Revision	A.05.00

### GSM 700

Selects GSM 700 as the band for the current step.

Key Path	Source, List Sequencer, List Sequencer Setup, Radio Setup, Radio Standard, GSM/EDGE
Initial S/W Revision	A.05.00

### T-GSM 810

Selects T-GSM 810 as the band for the current step.

Key Path	Source, List Sequencer, List Sequencer Setup, Radio Setup, Radio Standard, GSM/EDGE
Initial S/W Revision	A.05.00

### WCDMA

Pressing this key once selects WCDMA as the radio standard and the current WCDMA band as the active channel band. Pressing this key again allows access to the sub-menus for selecting a different WCDMA band.

Key Path	Source, List Sequencer, List Sequencer Setup, Radio Setup, Radio Standard
Initial S/W Revision	A.05.00

### Band I

Selects Band I as the band for the current step.

---

Key Path	Source, List Sequencer, List Sequencer Setup, Radio Setup, Radio Standard, WCDMA
Initial S/W Revision	A.05.00

---

#### Band II

Selects Band II as the band for the current step.

---

Key Path	Source, List Sequencer, List Sequencer Setup, Radio Setup, Radio Standard, WCDMA
Initial S/W Revision	A.05.00

---

#### Band III

Selects Band III as the band for the current step.

---

Key Path	Source, List Sequencer, List Sequencer Setup, Radio Setup, Radio Standard, WCDMA
Initial S/W Revision	A.05.00

---

#### Band IV

Selects Band IV as the band for the current step.

---

Key Path	Source, List Sequencer, List Sequencer Setup, Radio Setup, Radio Standard, WCDMA
Initial S/W Revision	A.05.00

---

#### Band V

Selects Band V as the band for the current step.

---

Key Path	Source, List Sequencer, List Sequencer Setup, Radio Setup, Radio Standard, WCDMA
Initial S/W Revision	A.05.00

---

#### Band VI

Selects Band VI as the band for the current step.

---

Key Path	Source, List Sequencer, List Sequencer Setup, Radio Setup, Radio Standard, WCDMA
Initial S/W Revision	A.05.00

---

#### Band VII

Selects Band VII as the band for the current step.

Key Path	Source, List Sequencer, List Sequencer Setup, Radio Setup, Radio Standard, WCDMA
Initial S/W Revision	A.05.00

**Band VIII**

Selects Band VIII as the band for the current step.

Key Path	Source, List Sequencer, List Sequencer Setup, Radio Setup, Radio Standard, WCDMA
Initial S/W Revision	A.05.00

**Band IX**

Selects Band IX as the band for the current step.

Key Path	Source, List Sequencer, List Sequencer Setup, Radio Setup, Radio Standard, WCDMA
Initial S/W Revision	A.05.00

**Band X**

Selects Band X as the band for the current step.

Key Path	Source, List Sequencer, List Sequencer Setup, Radio Setup, Radio Standard, WCDMA
Initial S/W Revision	A.05.00

**Band XI**

Selects Band XI as the band for the current step.

Key Path	Source, List Sequencer, List Sequencer Setup, Radio Setup, Radio Standard, WCDMA
Initial S/W Revision	A.05.00

**Band XII**

Selects Band XII as the band for the current step.

Key Path	Source, List Sequencer, List Sequencer Setup, Radio Setup, Radio Standard, WCDMA
Initial S/W Revision	A.05.00

**Band XIII**

Selects Band XIII as the band for the current step.

---

Key Path	Source, List Sequencer, List Sequencer Setup, Radio Setup, Radio Standard, WCDMA
Initial S/W Revision	A.05.00

---

#### Band XIV

Selects Band XIV as the band for the current step.

---

Key Path	Source, List Sequencer, List Sequencer Setup, Radio Setup, Radio Standard, WCDMA
Initial S/W Revision	A.05.00

---

#### LTE

Pressing this key once selects LTE FDD as the radio standard and the current LTE FDD band as the active channel band. Pressing this key again allows access to the sub-menus for selecting a different LTE FDD band.

---

Key Path	Source, List Sequencer, List Sequencer Setup, Radio Setup, Radio Standard
Initial S/W Revision	A.09.50

---

#### BAND 1

Selects BAND 1 as the band for the current step.

---

Key Path	Source, List Sequencer, List Sequencer Setup, Radio Setup, Radio Standard, LTE
Initial S/W Revision	A.09.50

---

#### BAND 2

Selects BAND 2 as the band for the current step.

---

Key Path	Source, List Sequencer, List Sequencer Setup, Radio Setup, Radio Standard, LTE
Initial S/W Revision	A.09.50

---

#### BAND 3

Selects BAND 3 as the band for the current step.

---

Key Path	Source, List Sequencer, List Sequencer Setup, Radio Setup, Radio Standard, LTE
Initial S/W Revision	A.09.50

---

**BAND 4**

Selects BAND 4 as the band for the current step.

Key Path	Source, List Sequencer, List Sequencer Setup, Radio Setup, Radio Standard, LTE
Initial S/W Revision	A.09.50

**BAND 5**

Selects BAND 5 as the band for the current step.

Key Path	Source, List Sequencer, List Sequencer Setup, Radio Setup, Radio Standard, LTE
Initial S/W Revision	A.09.50

**BAND 6**

Selects BAND 6 as the band for the current step.

Key Path	Source, List Sequencer, List Sequencer Setup, Radio Setup, Radio Standard, LTE
Initial S/W Revision	A.09.50

**BAND 7**

Selects BAND 7 as the band for the current step.

Key Path	Source, List Sequencer, List Sequencer Setup, Radio Setup, Radio Standard, LTE
Initial S/W Revision	A.09.50

**BAND 8**

Selects BAND 8 as the band for the current step.

Key Path	Source, List Sequencer, List Sequencer Setup, Radio Setup, Radio Standard, LTE
Initial S/W Revision	A.09.50

**BAND 9**

Selects BAND 9 as the band for the current step.

Key Path	Source, List Sequencer, List Sequencer Setup, Radio Setup, Radio Standard, LTE
Initial S/W Revision	A.09.50

#### BAND 10

Selects BAND 10 as the band for the current step.

Key Path	Source, List Sequencer, List Sequencer Setup, Radio Setup, Radio Standard, LTE
Initial S/W Revision	A.09.50

#### BAND 11

Selects BAND 11 as the band for the current step.

Key Path	Source, List Sequencer, List Sequencer Setup, Radio Setup, Radio Standard, LTE
Initial S/W Revision	A.09.50

#### BAND 12

Selects BAND 12 as the band for the current step.

Key Path	Source, List Sequencer, List Sequencer Setup, Radio Setup, Radio Standard, LTE
Initial S/W Revision	A.09.50

#### BAND 13

Selects BAND 13 as the band for the current step.

Key Path	Source, List Sequencer, List Sequencer Setup, Radio Setup, Radio Standard, LTE
Initial S/W Revision	A.09.50

#### BAND 14

Selects BAND 14 as the band for the current step.

Key Path	Source, List Sequencer, List Sequencer Setup, Radio Setup, Radio Standard, LTE
Initial S/W Revision	A.09.50

#### BAND 17

Selects BAND 17 as the band for the current step.

Key Path	Source, List Sequencer, List Sequencer Setup, Radio Setup, Radio Standard, LTE
Initial S/W Revision	A.09.50

**BAND 18**

Selects BAND 18 as the band for the current step.

Key Path	Source, List Sequencer, List Sequencer Setup, Radio Setup, Radio Standard, LTE
Initial S/W Revision	A.09.50

**BAND 19**

Selects BAND 19 as the band for the current step.

Key Path	Source, List Sequencer, List Sequencer Setup, Radio Setup, Radio Standard, LTE
Initial S/W Revision	A.09.50

**BAND 20**

Selects BAND 20 as the band for the current step.

Key Path	Source, List Sequencer, List Sequencer Setup, Radio Setup, Radio Standard, LTE
Initial S/W Revision	A.09.50

**BAND 21**

Selects BAND 21 as the band for the current step.

Key Path	Source, List Sequencer, List Sequencer Setup, Radio Setup, Radio Standard, LTE
Initial S/W Revision	A.09.50

**BAND 24**

Selects BAND 24 as the band for the current step.

Key Path	Source, List Sequencer, List Sequencer Setup, Radio Setup, Radio Standard, LTE
Initial S/W Revision	A.09.50

**BAND 25**

Selects BAND 25 as the band for the current step.

Key Path	Source, List Sequencer, List Sequencer Setup, Radio Setup, Radio Standard, LTE
Initial S/W Revision	A.09.50

### BAND 26

Selects BAND 26 as the band for the current step.

Key Path	Source, List Sequencer, List Sequencer Setup, Radio Setup, Radio Standard, LTE
Initial S/W Revision	A.12.53

### BAND 27

Selects BAND 27 as the band for the current step.

Key Path	Source, List Sequencer, List Sequencer Setup, Radio Setup, Radio Standard, LTE
Initial S/W Revision	A.14.00

### BAND 28

Selects BAND 28 as the band for the current step.

Key Path	Source, List Sequencer, List Sequencer Setup, Radio Setup, Radio Standard, LTE
Initial S/W Revision	A.14.00

### BAND 31

Selects BAND 31 as the band for the current step.

Key Path	Source, List Sequencer, List Sequencer Setup, Radio Setup, Radio Standard, LTE
Initial S/W Revision	A.14.00

### LTE TDD

Sets LTE TDD as the radio standard for use and accesses the LTE TDD specific channel band sub-menus..

Key Path	Source, Frequency, Radio Setup, Radio Standard
Initial S/W Revision	A.11.50

### BAND 33

Selects BAND 33 as the band for the current step.

Key Path	Source, Frequency, Radio Setup, Radio Standard, LTE TDD
<b>Example</b>	:SOUR:FREQ:CHAN:BAND BAND33
Initial S/W Revision	A.11.50



**BAND 34**

Selects BAND 34 as the band for the current step.

Key Path	Source, Frequency, Radio Setup, Radio Standard, LTE TDD
<b>Example</b>	:SOUR:FREQ:CHAN:BAND BAND34
Initial S/W Revision	A.11.50

**BAND 35**

Selects BAND 35 as the band for the current step.

Key Path	Source, Frequency, Radio Setup, Radio Standard, LTE TDD
<b>Example</b>	:SOUR:FREQ:CHAN:BAND BAND35
Initial S/W Revision	A.11.50

**BAND 36**

Selects BAND 36 as the band for the current step.

Key Path	Source, Frequency, Radio Setup, Radio Standard, LTE TDD
<b>Example</b>	:SOUR:FREQ:CHAN:BAND BAND36
Initial S/W Revision	A.11.50

**BAND 37**

Selects BAND 37 as the band for the current step.

Key Path	Source, Frequency, Radio Setup, Radio Standard, LTE TDD
<b>Example</b>	:SOUR:FREQ:CHAN:BAND BAND37
Initial S/W Revision	A.11.50

**BAND 38**

Selects BAND 38 as the band for the current step.

Key Path	Source, Frequency, Radio Setup, Radio Standard, LTE TDD
<b>Example</b>	:SOUR:FREQ:CHAN:BAND BAND38
Initial S/W Revision	A.11.50

### BAND 39

Selects BAND 39 as the band for the current step.

Key Path	Source, Frequency, Radio Setup, Radio Standard, LTE TDD
<b>Example</b>	:SOUR:FREQ:CHAN:BAND BAND39
Initial S/W Revision	A.11.50

### BAND 40

Selects BAND 40 as the band for the current step.

Key Path	Source, Frequency, Radio Setup, Radio Standard, LTE TDD
<b>Example</b>	:SOUR:FREQ:CHAN:BAND BAND40
Initial S/W Revision	A.11.50

### BAND 41

Selects BAND 41 as the band for the current step.

Key Path	Source, Frequency, Radio Setup, Radio Standard, LTE TDD
<b>Example</b>	:SOUR:FREQ:CHAN:BAND BAND41
Initial S/W Revision	A.11.50

### BAND 42

Selects BAND 42 as the band for the current step.

Key Path	Source, Frequency, Radio Setup, Radio Standard, LTE TDD
<b>Example</b>	:SOUR:FREQ:CHAN:BAND BAND42
Initial S/W Revision	A.11.50

### BAND 43

Selects BAND 43 as the band for the current step.

Key Path	Source, Frequency, Radio Setup, Radio Standard, LTE TDD
<b>Example</b>	:SOUR:FREQ:CHAN:BAND BAND43
Initial S/W Revision	A.11.50

#### BAND 44

Selects BAND 44 as the band for the current step.

Key Path	Source, List Sequencer, List Sequencer Setup, Radio Setup, Radio Standard, LTE TDD
Initial S/W Revision	A.14.00

#### TDSCDMA

Sets TDSCDMA as the radio standard for use and accesses the TDSCDMA specific channel band sub-menus..

Key Path	Source, Frequency, Radio Setup, Radio Standard
Initial S/W Revision	A.11.50

#### BAND A

Selects BAND A as the band for the current step.

Key Path	Source, Frequency, Radio Setup, Radio Standard, TDSCDMA
<b>Example</b>	:SOUR:FREQ:CHAN:BAND BANDA
Initial S/W Revision	A.11.50

#### BAND B

Selects BAND B as the band for the current step.

Key Path	Source, Frequency, Radio Setup, Radio Standard, TDSCDMA
<b>Example</b>	:SOUR:FREQ:CHAN:BAND BANDB
Initial S/W Revision	A.11.50

#### BAND C

Selects BAND C as the band for the current step.

Key Path	Source, Frequency, Radio Setup, Radio Standard, TDSCDMA
<b>Example</b>	:SOUR:FREQ:CHAN:BAND BANDC
Initial S/W Revision	A.11.50

#### BAND D

Selects BAND D as the band for the current step.

Key Path	Source, Frequency, Radio Setup, Radio Standard, TDSCDMA
<b>Example</b>	:SOUR:FREQ:CHAN:BAND BANDD
Initial S/W Revision	A.11.50

#### BAND E

Selects BAND E as the band for the current step.

Key Path	Source, Frequency, Radio Setup, Radio Standard, TDSCDMA
<b>Example</b>	:SOUR:FREQ:CHAN:BAND BANDE
Initial S/W Revision	A.11.50

#### BAND F

Selects BAND F as the band for the current step.

Key Path	Source, Frequency, Radio Setup, Radio Standard, TDSCDMA
<b>Example</b>	:SOUR:FREQ:CHAN:BAND BANDF
Initial S/W Revision	A.11.50

#### Radio Band Link

Allows you to specify the radio band link direction for the steps within the list sequence. The link is used in conjunction with the channel band and channel number to determine the output frequency.

When set to “Uplink”, the source will calculate the uplink frequency according to an uplink formula together with selected channel band and channel number. When set to “Downlink”, the source will calculate the downlink frequency according to a downlink formula together with selected channel band and channel number.

Key Path	Source, List Sequencer, List Sequencer Setup, Radio Setup
<b>Remote Command</b>	:SOURce:LIST:STEP[1] 2 3...1000:SETup:RADio:BAND:LINK DOWN UP :SOURce:LIST:STEP[1] 2 3...1000:SETup:RADio:BAND:LINK?
<b>Example</b>	:SOUR:LIST:STEP2:SET:RAD:BAND:LINK UP :SOUR:LIST:STEP2:SET:RAD:BAND:LINK?
Notes	SCPI is supported after A.09.40
Preset	DOWN
Range	DOWN   UP
Initial S/W Revision	A.05.00

## Channel

Allows you to specify the frequency of the current step via a channel number.

<b>Key Path</b>	Source, List Sequencer, List Sequencer Setup
<b>Remote Command</b>	:SOURce:LIST:STEP[1] 2 3...1000:SETup:CNFRrequency <double> :SOURce:LIST:STEP[1] 2 3...1000:SETup:CNFRrequency?
<b>Example</b>	:SOUR:LIST:STEP2:SET:CNFR 124 :SOUR:LIST:STEP2:SET:CNFR?
<b>Notes</b>	SCPI is supported after A.09.40. This SCPI is used to setup channel number or frequency setting, according to current Radio Band setting. If Radio Band is "NONE", then it's frequency. If Radio Band is not "NONE", then it's channel number.
<b>Couplings</b>	The channel number is coupled to the step frequency value. When the step frequency value is changed, the channel number will increase or decrease to match the new step frequency. If the step frequency is not at an exact match for a channel number, the nearest channel number is displayed, along with a greater than, or less than sign to indicate the frequency is above or below the channel number.
<b>Preset</b>	1
<b>Min</b>	0 (Please refer to for valid ranges.)
<b>Max</b>	10838 (Please refer to for valid ranges.)
<b>Initial S/W Revision</b>	A.05.00

## Frequency

Allows you to specify a frequency value for the current step.

<b>Key Path</b>	Source, List Sequencer, List Sequencer Setup
<b>Remote Command</b>	:SOURce:LIST:STEP[1] 2 3...1000:SETup:CNFRrequency <double> :SOURce:LIST:STEP[1] 2 3...1000:SETup:CNFRrequency?
<b>Example</b>	:SOUR:LIST:STEP2:SET:CNFR 1GHz :SOUR:LIST:STEP2:SET:CNFR?
<b>Notes</b>	SCPI is supported after A.09.40. This SCPI is used to setup channel number or frequency setting, according to current Radio Band setting. If Radio Band is "NONE", then it's frequency. If Radio Band is not "NONE", then it's channel number.
<b>Couplings</b>	The frequency value is coupled to the channel band and number for the step, such that updates to the radio band and channel number will update the frequency value to the corresponding absolute frequency. The reverse is also true, changing the frequency value causes the value of the channel number to be updated.
<b>Preset</b>	1.00 GHz
<b>Min</b>	10.00 MHz
<b>Max</b>	Hardware Dependand:

	Option 503 = 3.6 GHz Option 504 = 3.9 GHz Option 506 = 6.00 GHz
Initial S/W Revision	A.05.00

## Power

Allows you to specify a power value for the current step.

Key Path	Source, List Sequencer, List Sequencer Setup
Remote Command	:SOURce:LIST:STEP[1] 2 3...1000:SETup:AMPLitude <double> :SOURce:LIST:STEP[1] 2 3...1000:SETup:AMPLitude?
Example	:SOUR:LIST:STEP2:SET:AMPL -50dBm :SOUR:LIST:STEP2:SET:AMPL?
Notes	SCPI is supported after A.09.40
Notes	Amplitude corrections can be specified for use with the source. In the event of amplitude corrections being applied, the valid ranges for the RF power do not change dependant on the current amplitude correction setting. Instead, if the combination of RF power + amplitude correction is higher or lower than the source output range, the Source Unleveled bit is set and the "Source Unleveled" indicator will appear on status panel to indicate that the source cannot maintain the output power that has been requested.  The multiport adapter RFIO TX ports and GPS ports cannot ensure power accuracy when power setting is lower than -130dBm, this power setting value is defined by the sum of RF Power setting and related amplitude correction value. But user settable value could be lower than this limit. When application detected there exists power setting lower than -130dBm on MPA RFIO TX ports, then popup warning message . When application detected there exists power setting lower than -130dBm on MPA GPS ports, then popup warning message . These are only warning messages, and check is performed when RF is ON.
Notes	The Min and Max value here defined UI settable amplitude range. This range is larger than actual amplitude range with level accuracy defined in spec.
Dependencies	The RF power is dependent on the RF output port and frequency, such that the current frequency and selected output port determine the valid range of power values.
Preset	-100 dBm
Min	The range of values depends on the current frequency and selected RF output port. Please refer to "RF Power" on page 1379 and the table RF Power Range for the valid ranges.
Max	The range of values depends on the current frequency and selected RF output port. Please refer to "RF Power" on page 1379 and the table RF Power Range for the valid ranges.
Initial S/W Revision	A.05.00

## Waveform

Allows you access to the sub-menus for selecting the waveform to be played back during the current step. Pressing this key also changes the central display area to show the Waveform File Selection view.

Key Path	Source, List Sequencer, List Sequencer Setup
Remote Command	:SOURce:LIST:STEP[1] 2 3...1000:SETup:WAVeform <string> :SOURce:LIST:STEP[1] 2 3...1000:SETup:WAVeform?
Example	:SOUR:LIST:STEP2:SET:WAV "CW" :SOUR:LIST:STEP2:SET:WAV?
Notes	SCPI is supported after A.09.40
Remote Command Notes	String type, takes "Off"   "CW"   "Cont"   "waveform name"
Preset	CW
Range	Waveform   Continue Previous   CW   Off
Initial S/W Revision	A.05.00

### CW

Sets the current step to output a CW tone.

Key Path	Source, List Sequencer, List Sequencer Setup, Waveform
Example	:SOUR:LIST:STEP2:SET:WAV "CW"
Notes	SCPI is supported after A.09.40
Initial S/W Revision	A.05.00

### Selected Waveform

Inserts the currently selected waveform in the waveform selection view as the waveform for playback during the current step.

Key Path	Source, List Sequencer, List Sequencer Setup, Waveform
Example	:SOUR:LIST:STEP2:SET:WAV "waveform name"
Notes	SCPI is supported after A.09.40 If the selected waveform contains header (which contains ARB play parameters), source list sequence will automatically apply header settings of the selected waveform in that step.
Initial S/W Revision	A.05.00

### Continue Previous

Sets the current step to continue with playback of the waveform from the previous step. When continuing the previous waveform, the ARB playback will not pause while the source retunes to the new frequency or amplitude that may be defined for the new step.

Key Path	Source, List Sequencer, List Sequencer Setup, Waveform
----------	--------------------------------------------------------

<b>Example</b>	:SOUR:LIST:STEP2:SET:WAV "Cont"
<b>Notes</b>	SCPI is supported after A.09.40
<b>Initial S/W Revision</b>	A.05.00

### Off

Disable RF output of the current step.

<b>Key Path</b>	Source, List Sequencer, List Sequencer Setup, Waveform
<b>Example</b>	:SOUR:LIST:STEP2:SET:WAV "Off"
<b>Notes</b>	SCPI is supported after A.09.40
<b>Initial S/W Revision</b>	A.05.00

### Segments on Hard Disk

Allows you access to the sub-menus for loading waveform segments from the hard disk into ARB memory. The default directory is: D: varb.

Pressing this key changes the current view to the Waveform Management View.

<b>Key Path</b>	Source, Modulation Setup, ARB, Select Waveform
<b>Initial S/W Revision</b>	A.05.00

### Load Segment To ARB Memory

Allows you to load the selected file into ARB memory. On the front panel you select the file for loading to the ARB memory by highlighting the desired file in the list. Using the SCPI command, you specify the file name on the HDD.

"NVWFM" (none-volatile storage) MSUS (Mass Storage Unit Specifier) is supported in the memory subsystem because the ARB memory cannot be accessed directly. Therefore, files must be downloaded to the instrument hard disk and then loaded into the ARB memory. "NVWFM" MSUS will be mapped to the default directory D: VARB. The SCPI command supports using either "NVWFM" MSUS or specifying a full path. For more information, see Memory Subsystem (Remote Command Only).

If a file of the same name already exists within ARB memory, it is overwritten. If you wish to load two segments of the same name, you must rename one of the segments before loading it into ARB memory. To rename a segment, you can either use Windows File Explorer, or the :MMEMORY:COPY command.

NOTE: When a waveform file is loaded to ARB memory, burst timing adjustments are made automatically, based on whether or not a Multiport Adapter is connected to the test set and powered on. If the connection/power status of the Multiport Adapter is changed after a waveform file has been loaded, it needs to be loaded again.



Key Path	Source, Modulation Setup, ARB, Select Waveform, Segments on Hard Disk
Remote Command	:SOURce:RADio:ARB:LOAD <string>
Example	:SOUR:RAD:ARB:LOAD "D: VARB\testwaveform.bin" or :SOUR:RAD:ARB:LOAD "NVWFM:testwaveform.bin"
Notes	<p>Because loading the file involves a delay of unpredictable length, this command should be followed by the query *OPC?, which holds off subsequent commands until the loading operating is complete.</p> <p>&lt;string&gt; – specifies the path name of the file to load from the HDD into ARB memory. It could be a &lt;full path + filename&gt;, or &lt;"NVWFM" MSUS + colon + filename&gt;.</p> <p>When in Sequence Analyzer mode, and Include Source is Yes, an attempt to load a file to ARB memory will be rejected with an error.</p> <p>When Include Source is No and if there is insufficient free ARB memory to load the selected waveform, an error is generated. .</p> <p>If you specify a file over SCPI, but the file is not at the specified location, an error is generated.</p> <p>If you try to load a waveform file but the file contains less than 500 IQ samples, an error is generated.</p> <p>If you try to load a Signal Studio waveform "*.wfm" which contains invalid waveform header, an error is generated.</p> <p>If the ARB is ON when you load a file to ARB memory or delete a file from ARB memory, the playing waveform segment may not keep phase continuity during the ARB memory operation. The waveform will be replayed after the ARB operation is finished.</p> <p>ARB can be loaded into ARB memory even required licenses do not present on the instrument. In this case, a GUI only warning message -800, "Operation complete; Loaded &lt;filename&gt; successfully, but no license &lt;required licenses&gt; installed". User can install required licenses according to &lt;required licenses&gt; string to license it, or multi-pack license it.</p>
Initial S/W Revision	A.05.00

### Load All To ARB Memory

Allows you to load all the segment files within the currently selected directory into ARB memory. If a file of the same name already exists within ARB memory, it is overwritten. If you wish to load two segments of the same name, you must rename one of the segments before loading it into ARB memory. To rename a segment, you can either use Windows File Explorer, or the :MEMory:COPY command.

NOTE: When a waveform file is loaded to ARB memory, burst timing adjustments are made automatically, based on whether or not a Multiport Adapter is connected to the test set and powered on. If the connection/power status of the Multiport Adapter is changed after a waveform file has been loaded, it needs to be loaded again.

Key Path	Source, Modulation Setup, ARB, Select Waveform, Segments on Hard Disk
Remote Command	:SOURce:RADio:ARB:LOAD:ALL <string>
Example	:SOUR:RAD:ARB:LOAD:ALL "D: varb"
Notes	<p>&lt;string&gt; - specifies the directory on the HDD to load the files into ARB memory from.</p> <p>When in Sequence Analyzer mode, and Include Source is Yes, an attempt to load all files from a directory to ARB memory is rejected with an error.</p>

When Include Source is No and there is insufficient free ARB memory to load all the waveforms, when the ARB memory is full, the copy ceases, and an error is generated.  
If you specify a directory over SCPI, but the directory does not exist, an error is generated.  
If the ARB is ON, a user then loads or deletes file to ARB memory, the playing waveform segment may not keep phase continuity during the ARB memory operation. The waveform will be replayed after the ARB operation is finished.

Initial S/W Revision	A.05.00
----------------------	---------

### Change Directory...

Allows you to change the currently selected directory on the hard disk. Pressing this key opens a standard windows change directory dialog allowing you to select the new directory of interest.

The current directory is used for manually loading waveform segments into ARB memory for playback, and as a search location for waveform segments that are required to be loaded into ARB memory for playback of a waveform sequence or a list sequence.

Key Path	Source, Modulation Setup, ARB, Select Waveform, Segments on Hard Disk
Notes	No remote command, SCPI front panel only.
Initial S/W Revision	A.05.00

### Default Directory...

Allows you to change the default directory. It is used as a search location for waveform segments that are required to be loaded into ARB memory for playback of a waveform sequence, and as a search location for selecting waveforms using SCPI.

Key Path	Source, Modulation Setup, ARB, Select Waveform, Segments on Hard Disk
<b>Remote Command</b>	:SOURce:RADio:ARB:DEFault:DIRectory <string> :SOURce:RADio:ARB: DEFault:DIRectory?
<b>Example</b>	:SOUR:RAD:ARB:DEF:DIR "D:\ArbFiles" :SOUR:RAD:ARB:DEF:DIR?
State Saved	Persistent, survives a power cycle and a preset but not saved in the instrument state
Initial S/W Revision	A.05.00

### Segments in ARB Memory

Allows you access to the sub-menus for managing the files within ARB memory.

Key Path	Source, Modulation Setup, ARB, Select Waveform
Initial S/W Revision	A.05.00

### Delete Segment From ARB Mem

Allows you to remove a segment from ARB playback memory.

Key Path	Source, Modulation Setup, ARB, Select Waveform, Segments in ARB Memory
Remote Command	:SOURce:RADio:ARB:DELeTe <string>
Example	:SOUR:RAD:ARB:DEL "testwaveform.bin"
Notes	<p>&lt;string&gt; - specifies the waveform to be deleted from the ARB playback memory.</p> <p>When in Sequence Analyzer mode and Include Source is Yes, an attempt to delete a file from ARB memory is rejected with an error.</p> <p>When Include Source is No and you specify a file that does not exist within ARB memory, an error is generated.</p> <p>It is possible to delete files from within the ARB memory when the ARB is ON. However, if you attempt to delete the file that is currently playing an error is generated.</p> <p>It is possible to delete a file from within the ARB memory when the sequencer state is ON and the file is not being used by the List Sequencer. If you attempt to delete a file which is being used by the list sequencer, an error is generated.</p> <p>When sequencer state is On, even if ARB state is On, the selected waveform will not be played. In this case, if the selected waveform is not used in List Sequence, it can be deleted and the ARB state is turned Off.</p> <p>If the ARB is ON and you load a file to ARB memory or delete a file from ARB memory, the playing waveform segment may not keep phase continuity during the ARB memory operation. The waveform will be replayed after the ARB operation is finished.</p>
Initial S/W Revision	A.05.00

### Delete All From ARB Memory

Allows you to remove all segments from ARB playback memory.

Key Path	Source, Modulation Setup, ARB, Select Waveform, Segments in ARB Memory
Remote Command	:SOURce:RADio:ARB:DELeTe:ALL
Example	:SOUR:RAD:ARB:DELeTe:ALL
Notes	<p>When in Sequence Analyzer mode and Include Source is Yes, an attempt to delete all files from ARB memory is rejected with an error.</p> <p>When Include Source is No and you attempt to delete all files from ARB memory when the ARB is currently playing a file, all files except the one playing are deleted and an error is generated.</p> <p>If you attempt to delete all files from ARB memory when there are waveform files used in "<a href="#">List Sequencer</a>" on page 1449 and "<a href="#">Sequencer</a>" on page 1449 state is ON, all files except the files currently being used in list sequencer are deleted, and an error is generated.</p> <p>If the ARB is ON and you load a file to ARB memory or delete a file from ARB memory, the playing waveform segment may not keep phase continuity during the ARB memory operation. The waveform will be replayed after the ARB operation is finished.</p>
Initial S/W Revision	A.05.00

## Step Duration

Allows access to the sub-menus for setting up the duration of play for the current step.

The duration can be set to be either the number of times for the ARB file associated with the sequence to play, or a specific time value, or continuous. If the step is set to play a CW tone, the step duration cannot be set to a play count.

<b>Key Path</b>	Source, List Sequencer, List Sequencer Setup
<b>Remote Command</b>	:SOURce:LIST:STEP[1] 2 3...1000:SETup:DURation:TYPE TIME   COUNT   CONTinuous   CABort  :SOURce:LIST:STEP[1] 2 3...1000:SETup:DURation:TYPE?
<b>Example</b>	:SOUR:LIST:STEP2:SET:DUR:TYPE TIME :SOUR:LIST:STEP2:SET:DUR:TYPE?
<b>Notes</b>	SCPI is supported after A.09.40
<b>Notes</b>	If “Step Duration” is set to “Time” or “Play Count” for the last step, the last step of ARB keeps playing as if set to “Continuous”, until the set “Time” has expired or until the “Play Count” setting is reached. However, you can query <b>Error! Reference source not found.</b> Source Sweeping Condition Message to find out if the current list sequence is complete or not.
<b>Range</b>	Time   Play Count   Continuous   Continuous Abort
<b>Initial S/W Revision</b>	A.05.00

## Time

Sets the duration of the current step to be a time value for the length of time the step will play. Pressing this key again opens another menu which allows you to set the time value for the step duration.

<b>Key Path</b>	Source, List Sequencer, List Sequencer Setup, Step Duration
<b>Example</b>	:SOUR:LIST:STEP2:SET:DUR:TYPE TIME
<b>Notes</b>	SCPI is supported after A.09.40
<b>Initial S/W Revision</b>	A.05.00

## Duration Time

Allows you to specify the length of time the current step will play.

If the Transition Time value is longer than the Step Duration Time, an error is generated when initiating a source list sequence. For source list sequence, transition time is included in the step duration length (not occupy additional time). If the Transition Time value is longer than the Step Duration Time, the real step duration length is extended to equal the transition time and cause a timing shift. This check is also described in section **Error! Reference source not found.** List Sequence Step Validation.

<b>Key Path</b>	Source, List Sequencer, List Sequencer Setup, Step Duration, Time
<b>Remote Command</b>	:SOURce:LIST:STEP[1] 2 3...1000:SETup:DURation:TCOUNT <double> :SOURce:LIST:STEP[1] 2 3...1000:SETup:DURation:TCOUNT?

<b>Example</b>	:SOUR:LIST:STEP2:SET:DUR:TCO 1s :SOUR:LIST:STEP2:SET:DUR:TCO?
Notes	SCPI is supported after A.09.40 This SCPI is reused by "Play Count", "Duration Time" and "Continuous Abort" according to current Duration Type setting is "Play Count" or "Duration Time" or "Continuous Abort". If current "Duration Type" is "Continuous", then popup error -221, "Settings conflict;Cannot accept time or count input when step duration type is Continuous on step #"
Notes	If "Duration Time" is set for the last step, the last step of ARB keeps playing as if set to "Continuous" after set time expires. However, you can query Source Sweeping Condition Message (:STAT:OPER:COND?) to find out if the current list sequence is complete or not.
Preset	1.00 ms
Min	100 μs
Max	1800 s
Initial S/W Revision	A.05.00

### Play Count

Sets the duration of the current step to be an integer value for the number of times (play count) the ARB file is selected for playback during this step. For example, a 5 second ARB will be set to play 5 times during the step.

Key Path	Source, List Sequencer, List Sequencer Setup, Step Duration
<b>Example</b>	:SOUR:LIST:STEP2:SET:DUR:TYPE COUN
Notes	SCPI is supported after A.09.40 This key is unavailable and is grayed out if the current step is configured to CW tone rather than an ARB waveform.
Initial S/W Revision	A.05.00

### Header Utilities

Allows access to the header utilities sub-menu. Pressing this key also causes the central display area to change to display the File Header Information view.

Key Path	Source, Modulation Setup, ARB
Dependencies	This key is only available if there is currently a waveform selected for playback. If no waveform is selected, the key is grayed out.
Initial S/W Revision	A.05.00

### Continuous

Sets the current step to be played continuously until the next step starts. The waveform will always play completely before transitioning to the next step.

Key Path	Source, List Sequencer, List Sequencer Setup, Step Duration
<b>Example</b>	:SOUR:LIST:STEP2:SET:DUR:TYPE CONT
Notes	SCPI is supported after A.09.40
Initial S/W Revision	A.05.00

### Output Trigger

Allows you to specify the trigger output for the current step. The trigger output signal is sent at the start of the step.

When select “On”, trigger event will occur on both Internal and External2 paths. Select “Off” will turn off trigger output.

Key Path	Source, List Sequencer, List Sequencer Setup
<b>Remote Command</b>	:SOURce:LIST:STEP [1]   2   3...1000:SETup:OUTPut:TRIGger ON   OFF   1   0 :SOURce:LIST:STEP [1]   2   3...1000:SETup:OUTPut:TRIGger
<b>Example</b>	:SOUR:LIST:STEP2:SET:OUTP:TRIG ON :SOUR:LIST:STEP2:SET:OUTP:TRIG?
Notes	SCPI is supported after A.09.40
Preset	Off
Range	On Off
Initial S/W Revision	A.05.00

### Repetition

Allows access to the sub-menu for selecting the repetition type for the list sequencer globally. It cannot be changed between different sequence steps.

Key Path	Source, List Sequencer
<b>Remote Command</b>	:SOURce:LIST:REPetition:TYPE SINGLE CONTInuous
<b>Example</b>	:SOUR:LIST:REP:TYPE SING :SOUR:LIST:REP:TYPE?
Preset	SINGLE
Range	SINGLE CONTInuous
Initial S/W Revision	A.14.50

### Single

Sets the repetition type as single for the whole source sequence. Source list will play one time after initiation.

Key Path	Source, List Sequencer, Repetition
<b>Example</b>	:SOUR:LIST:REP:TYPE SINGLE
Initial S/W Revision	A.14.50

### Continuous

Sets the repetition type as continuous for the whole source sequence. Source list will play continuously after initiation.

Key Path	Source, List Sequencer, Repetition
<b>Example</b>	:SOUR:LIST:REP:TYPE CONTInuous
Initial S/W Revision	A.14.50

### Trigger Type

Allows access to the sub-menu for selecting the output trigger type for the list sequencer globally. It cannot be changed between different sequence steps.

Key Path	Source, List Sequencer
<b>Remote Command</b>	:SOURce:LIST:TRIGgerout:TYPe BEGInningofstep DATamarker
<b>Example</b>	:SOUR:LIST:TRIG:TYP BEG :SOUR:LIST:TRIG:TYP?
Notes	SCPI is supported after A.14.00
Preset	BEGInningofstep
Range	BEGInningofstep DATamarker
Initial S/W Revision	A.14.00

### BeginningOfStep

Sets the output trigger type as BeginningOfStep for the whole source sequence.

Key Path	Source, List Sequencer, Trigger Type
<b>Example</b>	:SOUR:LIST:TRIG:TYP BEG
Notes	SCPI is supported after A.14.00
Initial S/W Revision	A.14.00

### DataMarker

Sets the output trigger type as DataMarker for the whole source sequence. When DataMarker is selected, which marker to route is also needed to be set.

Key Path	Source, List Sequencer, Trigger Type
<b>Example</b>	:SOUR:LIST:TRIG:TYP DAT
Notes	SCPI is supported after A.14.00
Initial S/W Revision	A.14.00

### Marker 1

Sets the output trigger maker routing to Marker 1 for DataMarker in the whole source sequence.

Key Path	Source, List Sequencer, Trigger Type, DataMarker
<b>Example</b>	:SOUR:LIST:TRIG:TYPE:MARK M1
Notes	SCPI is supported after A.14.00
Initial S/W Revision	A.14.00

### Marker 2

Sets the output trigger maker routing to Marker 2 for DataMarker in the whole source sequence.

Key Path	Source, List Sequencer, Trigger Type, DataMarker
<b>Example</b>	:SOUR:LIST:TRIG:TYPE:MARK M2
Notes	SCPI is supported after A.14.00
Initial S/W Revision	A.14.00

### Marker 3

Sets the output trigger maker routing to Marker 3 for DataMarker in the whole source sequence.

Key Path	Source, List Sequencer, Trigger Type, DataMarker
<b>Example</b>	:SOUR:LIST:TRIG:TYPE:MARK M3
Notes	SCPI is supported after A.14.00
Initial S/W Revision	A.14.00



### Marker 4

Sets the output trigger maker routing to Marker 4 for DataMarker in the whole source sequence.

Key Path	Source, List Sequencer, Trigger Type, DataMarker
<b>Example</b>	:SOUR:LIST:TRIG:TYPE:MARK M4
Notes	SCPI is supported after A.14.00
Initial S/W Revision	A.14.00

### Manual Trigger Now

Pressing this key provides a software trigger event to the list sequencer. During execution of sequence, if the sequencer is halted on any step that has been configured with a “Manual” step trigger, then this key press will cause the sequencer to continue and execute the step.

Key Path	Source, List Sequencer
<b>Remote Command</b>	No remote command, front panel only.
Initial S/W Revision	A.05.00

### Source Preset

Allows you to preset the source settings to their default values.

Key Path	Source
<b>Remote Command</b>	:SOURce:PRESet
<b>Example</b>	:SOUR:PRES

## Span X Scale

Accesses a menu of functions that enable you to set the horizontal scale parameters.

Key Path	Front-panel key
Initial S/W Revision	A.11.00

### Ref Value

Sets the X reference value.

Key Path	SPAN X Scale
Mode	BASIC, PNOISE, WCDMA, C2K, GSM, WIMAXOFDMA, TDSCDMA, 1XEVDO, DVB, DTMB, ISDBT, CMMB, LTE, LTETDD, DCTV, WLAN, MSR, LTEAFDD, LTEATDD
Remote Command	:DISPlay:SEMask:VIEW[1]:WINDow[1]:TRACe:X[:SCALe]:RLEVel <freq> :DISPlay:SEMask:VIEW[1]:WINDow[1]:TRACe:X[:SCALe]:RLEVel?
Example	DISP:SEM:VIEW:WIND:TRAC:X:RLEV 10 DISP:SEM:VIEW:WIND:TRAC:X:RLEV?
Notes	You must be in the mode that includes SEM measurement to use this command. Use :INSTrument:SElect to set the mode.
Couplings	If Auto Scaling is set to On, this value is automatically determined by the measurement result. When you set this value manually, Auto Scaling automatically changes to Off.
Preset	1.0 GHz
State Saved	Saved in instrument state.
Min	-1000 GHz
Max	1000 GHz
Default Unit	Hz
Initial S/W Revision	A.11.00

### Scale/Div

Sets the horizontal scale.

Key Path	SPAN X Scale
Mode	BASIC, PNOISE, WCDMA, C2K, GSM, WIMAXOFDMA, TDSCDMA, 1XEVDO, DVB, DTMB, ISDBT, CMMB, LTE, LTETDD, DCTV, WLAN, MSR, LTEAFDD, LTEATDD
Remote Command	:DISPlay:SEMask:VIEW[1]:WINDow[1]:TRACe:X[:SCALe]:PDIVision <freq> :DISPlay:SEMask:VIEW[1]:WINDow[1]:TRACe:X[:SCALe]:PDIVision ?
Example	DISP:SEM:VIEW:WIND:TRAC:X:PDIV 500 DISP:SEM:VIEW:WIND:TRAC:X:PDIV?

Notes	You must be in a mode that includes the SEM measurement to use this command. Use INSTRUMENT:SElect to set the mode.
Couplings	If Auto Scaling is set to On, this value is automatically determined by the measurement result. When you set this value manually, Auto Scaling automatically changes to Off.
Preset	Automatically Calculated
State Saved	Yes Saved in instrument state.
Min	1 Hz
Max	10.0 GHz
Initial S/W Revision	A.11.00

## Ref Position

Sets the reference position for the X axis to Left, Center or Right.

Key Path	SPAN X Scale
Mode	BASIC, PNOISE, WCDMA, C2K, GSM, WIMAXOFDMA, TDSCDMA, 1XEVD0, DVB, DTMB, ISDBT, CMMB, LTE, LTETDD, DCTV, WLAN, MSR, LTEAFDD, LTEATDD
Remote Command	:DISPlay:SEMask:VIEW[1]:WINDow[1]:TRACe:X[:SCALE]:RPOStion LEFT   CENTER   RIGHT  :DISPlay:SEMask:VIEW[1]:WINDow[1]:TRACe:X[:SCALE]:RPOStion?
Example	DISP:SEM:VIEW:WIND:TRAC:X:RPOS LEFT DISP:SEM:VIEW:WIND:TRAC:X:RPOS?
Notes	You must be in a mode that includes the SEM measurement to use this command. Use INSTRUMENT:SElect to set the mode.
Preset	CENTER
State Saved	Yes Saved in instrument state.
Range	Left Ctr Right
Initial S/W Revision	A.11.00

## Auto Scaling

Toggles the scale coupling function between On and Off.

Key Path	SPAN X Scale
Mode	BASIC, PNOISE, WCDMA, C2K, GSM, WIMAXOFDMA, TDSCDMA, 1XEVD0, DVB, DTMB, ISDBT, CMMB, LTE, LTETDD, DCTV, WLAN, MSR, LTEAFDD, LTEATDD
Remote Command	:DISPlay:SEMask:VIEW[1]:WINDow[1]:TRACe:X[:SCALE]:COUPle 0   1   OFF   ON  :DISPlay:SEMask:VIEW[1]:WINDow[1]:TRACe:X[:SCALE]:COUPle?
Example	DISP:SEM:VIEW:WIND:TRAC:X:COUP ON

DISP:SEM:VIEW:WIND:TRAC:X:COUP?	
Notes	You must be in a mode that includes the SEM measurement to use this command. Use INSTRUMENT:SElect to set the mode.
Couplings	When Auto Scaling is On and the Restart front-panel key is pressed, this function automatically determines the scale per division and reference values based on the measurement results. When you set a value to either Scale/Div or Ref Value manually, Auto Scaling automatically changes to Off.
Preset	1
State Saved	Yes Saved in instrument state.
Range	On Off
Initial S/W Revision	A.11.00

## Sweep/Control

Displays a menu that enables you to set up and control the sweep time, gate method, and source of the current measurement. See Sweep/Control for more information.

Key Path	Front-panel key
Initial S/W Revision	Prior to A.02.00

### Pause

Pauses a measurement after the current data acquisition is complete. When Paused, the label on the key changes to Resume. Pressing the Resume key resumes the measurement at the point it was at when paused. See Pause/Resume for more details.

Key Path	Sweep/Control
Initial S/W Revision	Prior to A.02.00

### Gate

Accesses a menu that enables you to control the gating function. The Gate functionality is used to view signals best viewed by qualifying them with other events.

Gate setup parameters are the same for all measurements – they do not change as you change measurements. Settings like these are called “Meas Global” and are unaffected by Meas Preset.

Key Path	Sweep/Control
Scope	Meas Global
Readback	The state and method of Gate, as [Off, FFT] or [On, FFT]. Note that for measurements that only support gated FFT, the method is nonetheless read back, but always as FFT.
Initial S/W Revision	Prior to A.02.00

### Gate On/Off

Turns the gate function on and off.

When the Gate Function is on, the selected Gate Method is used along with the gate settings and the signal at the gate source to control the sweep system with the gate signal. Not all measurements allow every type of Gate Methods.

When Gate is on, the annunciation in the measurement bar reflects that it is on and what method is used, as seen in the following "Gate: FFT" annunciator graphic.

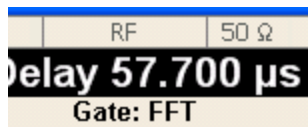

Key Path	Sweep/Control, Gate
Remote Command	[ :SENSe ] :SWEep:EGATe [ :STATe ] OFF ON 0 1 [ :SENSe ] :SWEep:EGATe [ :STATe ] ?
Example	SWE:EGAT ON SWE:EGAT?
Dependencies	<p>When in the ACP measurement:</p> <ul style="list-style-type: none"> <li>• When Meas Method is RBW or FAST, this function is unavailable and the key is grayed out.</li> <li>• Whenever Gate is on, Meas Method, RBW or FAST is unavailable and keys for those are grayed out.</li> <li>• When Gate is on, Offset Res BW and Offset Video BW are ignored (if you set these values) and the measurement works as if all Offset Res BW and all Offset Video BW are coupled with the Res BW and the Video BW under the BW menu. When Gate is on, the Offset BW key in the Offset/Limit menu is grayed out.</li> </ul>
Preset	Off LTETDD: On
State Saved	Saved in instrument state
Range	On Off
Backwards Compatibility SCPI	[ :SENSe ] :SWEep:TIME:GATE [ :STATe ] ESA compatibility
Backwards Compatibility Notes	In ESA, Trig Delay (On) and Gate (On) could not be active at the same time.. This dependency does not exist in PSA or in the X-Series.
Initial S/W Revision	Prior to A.02.00

## Gate View On/Off

Turning on Gate View in the Swept SA measurement provides a single-window gate view display..

Turning on Gate View in other measurements shows the split-screen Gate View. In these measurements, when the Gate View is on, the regular view of the current measurement traces and results are reduced vertically to about 70% of the regular height. The Zero Span window, showing the positions of the Gate, is shown between the Measurement Bar and the reduced measurement window. By reducing the height of the measurement window, some of the annotation on the Data Display may not fit and is not shown.

Key Path	Sweep/Control, Gate
Remote Command	[ :SENSe ] :SWEep:EGATe:VIEW ON OFF 1 0 [ :SENSe ] :SWEep:EGATe:VIEW?
Example	SWE:EGAT:VIEW ON turns on the gate view.

Dependencies	<p>In the Swept SA measurement:</p> <p>In Gate View, the regular Acq Time key is grayed out . When pressed, the grayed out key puts up the informational message "Use Gate View Sweep Time in the Gate menu."</p> <p>In the other measurements:</p> <p>When you turn Gate View on, the lower window takes on the current state of the instrument. Upon leaving Gate View, the instrument takes on the state of the lower window.</p> <p>When you turn Gate View on, the upper window Acquisition Time is set to the gate view acquisition time.</p>
Couplings	<p>These couplings apply to the Swept SA measurement:</p> <ul style="list-style-type: none"> <li>• When Gate View is turned on, the instrument is set to Zero Span.</li> <li>• Gate View automatically turns off whenever a Span other than Zero is selected.</li> <li>• Gate View automatically turns off if you press the Last Span key while in Gate View, and the instrument returns to the Span it was in before entering Gate View (even if that is Zero Span).</li> <li>• When Gate View is turned on, the sweep time used is the gate view sweep time. This is set according to the rules in section "<a href="#">Gate View Setup</a>" on page 1157</li> <li>• When Gate View is turned off, Sweep Time is set to the normal Swept SA measurement sweep time.</li> <li>• If Gate View is on and Gate is off, then turning on Gate turns off Gate View.</li> </ul>
Preset	OFF
State Saved	Saved in instrument state
Range	On Off
Initial S/W Revision	Prior to A.02.00

A sample of the Gate View screen in the Swept SA measurement is shown in the following graphic :

## 10 Spectrum Emission Mask Measurement Sweep/Control

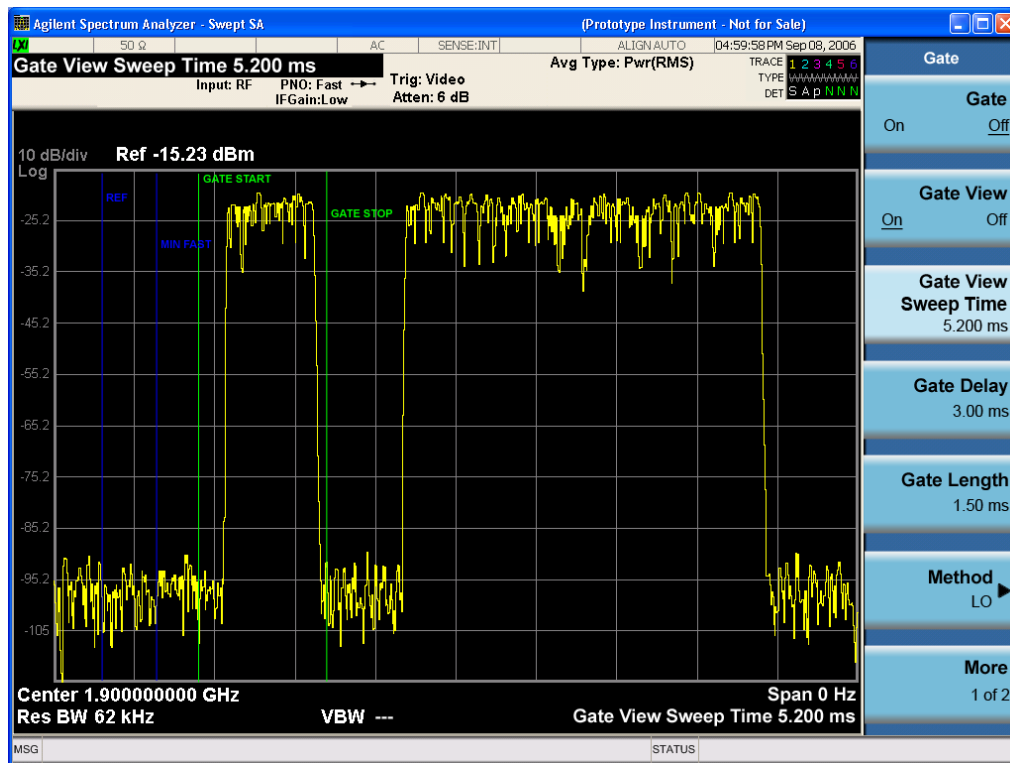

A sample of the Gate View screen in other measurements is shown in the following graphic. This example is for the ACP measurement:

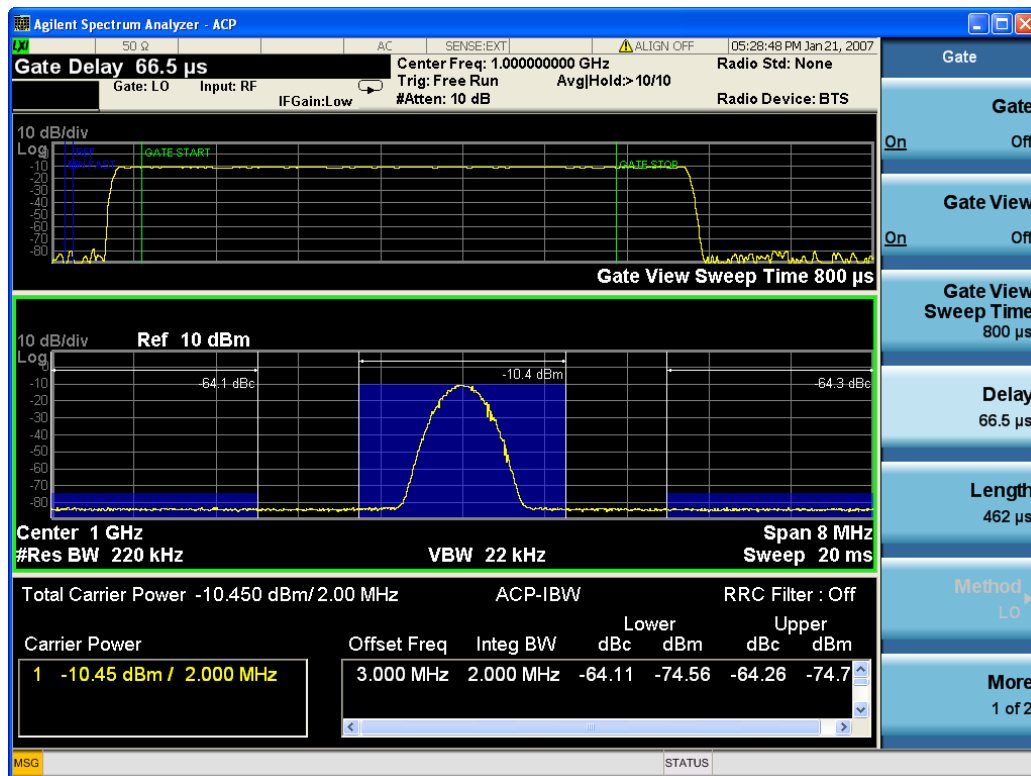



Turning Gate View off returns the analyzer to the Normal measurement view.

In the Swept SA, the normal measurement view is the single-window Swept SA view. When returning to this view, the Swept SA measurement returns to the Span it was in before entering **Gate View** (even if that is Zero Span).

The **Gate View** window is triggered from the Gate Source, with zero trigger delay. Also, when updating the **Gate View** window, the Gate itself must not operate. So it is internally shut off while the gate view window is being updated. For the Swept SA measurement, this means that the Gate is internally shut off whenever the gate view window is displayed. The measurement bar and softkeys continue to show the Trigger source for the main sweep window and give no indication that the Gate is shut off or that the Gate View window is triggered from the Gate Source.

When in **Gate View**, vertical lines are displayed in the Gate View window as follows:

- Green lines are displayed at the gate edges as follows: in Edge Gate, a line is shown for Delay and one for the end of the Gate period, defined by Length. You can adjust the position of the green lines by adjusting the gate length and the gate delay. These lines update in the Gate View window as the active function changes, even if the window is not being updated. In Gated FFT, their location is relative to the left edge of the screen.
- A blue line is displayed showing the delay reference, that is, the reference point for the Gate Delay within the Zero Span window. The blue line represents where (in time) the effective location of the gate start would be if the gate were programmed to zero delay.

- 

## Gate View Setup

Accesses a menu that enables you to setup parameters relevant to the Gate View

Key Path	Sweep/Control, Gate
Scope	Meas Global
Initial S/W Revision	A.10.00

## Gate View Acquisition Time

Controls the acquisition time in the Gate View window. To provide an optimal view of the gate signal, the analyzer initializes Gate View Acq Time based on the current settings of Gate Delay and Gate Length.

Key Path	Sweep/Control, Gate, Gate View Setup
<b>Remote Command</b>	[ :SENSe ] :SWEep:EGATe:TIME <time> [ :SENSe ] :SWEep:EGATe:TIME?
<b>Example</b>	SWE:EGAT:TIME 500 ms
Dependencies	Gate View Acquisition Time is initialized: <ul style="list-style-type: none"> <li>• On Preset (after initializing delay and length).</li> <li>• Every time the Gate Method is set/changed.</li> </ul> 1. Compute the location of the "gate stop" line, which you know is at time $t = t_{min} + GateDelay +$

GateLength.	
Preset	519.3 $\mu$ s WiMAX OFDMA: 5 ms GSM/EDGE: 1 ms
State Saved	Saved in instrument state
Min	100 ns
Max	6000 s
Initial S/W Revision	Prior to A.02.00

### Gate View Start Time

Controls the time at the left edge of the Gate View.

Key Path	Sweep/Control, Gate, Gate View Setup
<b>Remote Command</b>	[ :SENSe ] :SWEep:EGATe:VIEW:STARt <time> [ :SENSe ] :SWEep:EGATe:VIEW:STARt?
<b>Example</b>	SWE:EGAT:VIEW:STAR 10ms
Notes	Units of time are required or no units; otherwise an invalid suffix error message will be generated. See error -131.
Preset	0 ms
State Saved	Saved in instrument state
Min	0
Max	500 ms
Initial S/W Revision	A.10.00

### Gate Delay

Controls the length of time from the time the gate condition goes True until the gate is turned on.

Key Path	Sweep/Control, Gate
<b>Remote Command</b>	[ :SENSe ] :SWEep:EGATe:DELay <time> [ :SENSe ] :SWEep:EGATe:DELay?
<b>Example</b>	SWE:EGAT:DELay 500ms SWE:EGAT:DELay?
Notes	Units of time are required or no units; otherwise an invalid suffix error message will be generated.
Preset	57.7 $\mu$ s WiMAX OFDMA: 71 $\mu$ s GSM/EDGE: 600 $\mu$ s

	WLAN: 500 us WLAN: 36 us
State Saved	Saved in instrument state
Min	0.0 us
Max	100 s
<b>Backwards Compatibility SCPI</b>	[:SENSe]:SWEep:TIME:GATE:DELay ESA compatibility
Initial S/W Revision	Prior to A.02.00

## Gate Length

Controls the length of time that the gate is on after it opens.

Key Path	Sweep/Control, Gate
<b>Remote Command</b>	[:SENSe]:SWEep:EGATe:LENGth <time> [:SENSe]:SWEep:EGATe:LENGth?
<b>Example</b>	SWE:EGAT:LENG 1 SWE:EGAT:LENG?
Notes	Units of time are required or no units; otherwise an invalid suffix error message will be generated.
Preset	461.6 us WiMAX OFDMA: 50 us GSM/EDGE: 200 us WLAN: 1.54 ms WLAN: 32 us
State Saved	Saved in instrument state
Min	100 ns
Max	5 s
<b>Backwards Compatibility SCPI</b>	[:SENSe]:SWEep:TIME:GATE:LENGth ESA compatibility
Initial S/W Revision	Prior to A.02.00

## Gate Source

The menus under the Gate Source key are the same as those under the Trigger key, with the exception that neither Free Run nor Video are available as Gate Source selections. However, a different SCPI command is used to select the Gate Source (see table below) because you may independently set the Gate Source and the Trigger Source.

Any changes to the settings in the setup menus under each Gate Source selection key (for example: Trigger Level, Trigger Delay, etc.) also affect the corresponding settings under the Trigger menu keys. The SCPI commands used for these are the same for Trigger and Gate, since there is only one setting which affects both Gate and Trigger. Example: to set the Trigger Level for External 1 you use the command :TRIG:EXT1:LEV regardless of whether you are using External 1 as a Trigger Source or a Gate Source.

Key Path	Sweep/Control, Gate
Remote Command	[ :SENSe ] :SWEep:EGATe:SOURce EXTernal1   EXTernal2   LINE   FRAME   RFBurst  [ :SENSe ] :SWEep:EGATe:SOURce?
Dependencies	In some models, there is no second External input. In these models, the External 2 key is blanked and the EXTernal2 parameter will generate a "Hardware missing; Not available for this model number" error.
Preset	EXTernal 1 GSM/EDGE, MSR: FRAME LTETDD: EXTernal 1When Direction is Downlink, FRAME when Direction is Uplink.
Initial S/W Revision	Prior to A.02.00
Modified at S/W Revision	A.03.00, A.14.00

### Video (IF Envelope)

Pressing this key, when it is not selected, selects the video signal as the trigger. The Video trigger condition is met when the video signal (the filtered and detected version of the input signal, including both RBW and VBW filtering) crosses the video trigger level.

**NOTE** When the detector selected for all active traces is the average detector, the video signal for triggering does not include any VBW filtering.

The video trigger level is shown as a labeled line on the display. The line is displayed as long as video is the selected trigger source.

Pressing this key, when it is already selected, accesses the video trigger setup functions.

Key Path	Trigger
Example	TRIG:SOUR VID Swept SA measurement TRIG:< meas > :SOUR VID Measurements other than Swept SA
Notes	Log Plot and Spot Frequency measurements do not support Video Trigger
Dependencies	Video trigger is allowed in average detector mode.
State Saved	Saved in instrument state
Status Bits/OPC dependencies	The Status Operation Register bit 5 "Waiting for Trigger" is set at the same time as the Sweeping or Measuring bit is set. It is cleared when the trigger actually occurs (that is, after the trigger event occurs and all the applicable trigger criteria have been met). A corresponding pop-up message ("Waiting for trigger") is generated if no trigger signal appears after approximately 2 sec. This message goes away when a trigger signal appears.

Backwards Compatibility Notes	In the past, the Average detector was not available when Video triggering was on, and consequently, functions that set the detector to average (such as Marker Noise or Band/Intvl Power) were not available when the video trigger was on. Similarly, Video triggering was not available when the detector was Average. In the X-Series, these restrictions are removed.
Initial S/W Revision	Prior to A.02.00

### Trigger Level

Sets a level for the video signal trigger. When the video signal crosses this level, with the chosen slope, the trigger occurs. This level is displayed with a horizontal line only if **Video** is the selected trigger source.

Key Path	Trigger, Video
Remote Command	:TRIGger[:SEquence]:VIDeo:LEVel <ampl> :TRIGger[:SEquence]:VIDeo:LEVel?
Example	TRIG:VID:LEV -40 dBm
Notes	<p>When sweep type = FFT, the video trigger uses the amplitude envelope in a bandwidth wider than the FFT width as a trigger source. This might often be useful, but does not have the same relationship between the displayed trace and the trigger level as in swept triggering.</p> <p>Amplitude Corrections are not taken into account by the Video Trig Level. For example, if you have given yourself effective gain with an amplitude correction factor, the Video Trigger will not fire until you have dropped the trigger line that far below the displayed signal level, rather than simply dropping it down to the displayed signal level.</p> <p>Note that other corrections, specifically External Gain and Ref Level Offset, modify the actual trace data as it is taken and therefore ARE taken into account by Trig Level.</p>
Couplings	This same level is used for the Video trigger source in the Trigger menu and for the Video selection in the Gate Source menu.
Preset	Set the Video Trigger Level -25 dBm on Preset. When the Video Trigger Level becomes the active function, if the value is off screen, set it to either the top or bottom of screen, depending on which direction off screen it was.
State Saved	Saved in instrument state
Min	-170 dBm
Max	+30 dBm
Default Unit	Depends on the current selected Y axis unit
Backwards Compatibility SCPI	:TRIGger[:SEquence]:IF:LEVel :TRIGger[:SEquence]:IF:LEVel?
Backwards Compatibility Notes	This alias is provided for backward compatibility with VSA/PSA comms apps.
Initial S/W Revision	Prior to A.02.00

### Trig Slope

Controls the trigger polarity. It is set positive to trigger on a rising edge and negative to trigger on a falling edge.

<b>Key Path</b>	Trigger, Video
<b>Remote Command</b>	:TRIGger[:SEquence]:VIDeo:SLOPe POSitive NEGative :TRIGger[:SEquence]:VIDeo:SLOPe?
<b>Example</b>	TRIG:VID:SLOP NEG
<b>Preset</b>	POSitive
<b>State Saved</b>	Saved in instrument state
<b>Backwards Compatibility SCPI</b>	:TRIGger[:SEquence]:IF:SLOPe NEGative POSitive :TRIGger[:SEquence]:IF:SLOPe? For backward compatibility with VSA/PSA comms apps
<b>Backwards Compatibility Notes</b>	The legacy :TRIGger[:SEquence]:SLOPe command affects the slopes for the VID, LINE, EXT1, EXT2, and RFB triggers.
<b>Initial S/W Revision</b>	Prior to A.02.00

<b>Remote Command</b>	:TRIGger[:SEquence]:SLOPe POSitive NEGative :TRIGger[:SEquence]:SLOPe?
<b>Example</b>	TRIG:SLOP NEG
<b>Preset</b>	POSitive
<b>State Saved</b>	Saved in instrument state
<b>Backwards Compatibility Notes</b>	In ESA/PSA, the Trigger Slope was global to all triggers. In the X-Series, the slope can be set individually for each Trigger Source. For backward compatibility, the global SLOPe command updates all instances of trigger slope (VID, LINE, EXT1, EXT2, TV, RFB). The query returns the trigger slope setting of the currently selected trigger source.
<b>Initial S/W Revision</b>	Prior to A.02.00

### External 1

Pressing this key, when it is not selected, selects an external input signal as the trigger. A new sweep/measurement will start when the external trigger condition is met using the external 1 input connector on the rear panel.

Pressing this key, when it is already selected, accesses the external 1 trigger setup menu.

<b>Key Path</b>	Trigger
<b>Example</b>	TRIG:SOUR EXT1 Swept SA measurement TRIG:<meas>:SOUR EXT1 Measurements other than Swept SA
<b>Dependencies</b>	Grayed out if in use by Point Trigger in the Source Setup menu. Forced to Free Run if already selected and Point Trigger is set to External 1.

State Saved	Saved in instrument state
Status Bits/OPC dependencies	The Status Operation Register bit 5 "Waiting for Trigger" is set at the same time as the Sweeping or Measuring bit is set. It is cleared when the trigger actually occurs (that is, after the trigger event occurs and all the applicable trigger criteria have been met). A corresponding pop-up message ("Waiting for trigger") is generated if no trigger signal appears after approximately 2 sec. This message goes away when a trigger signal appears.
Initial S/W Revision	Prior to A.02.00

### Trigger Level

Sets the value where the external 1 trigger input will trigger a new sweep/measurement.

Key Path	Trigger, External 1
<b>Remote Command</b>	:TRIGger[:SEquence]:EXTernal1:LEVel <level> :TRIGger[:SEquence]:EXTernal1:LEVel?
<b>Example</b>	TRIG:EXT1:LEV 0.4 V
Couplings	This same level is used for the Ext1 trigger source in the Trigger menu, for the Ext1 selection in the Periodic Timer sync source (in the Trigger menu and in the Gate Source menu), and also for the Ext1 selection in the Gate Source menu.
Preset	1.2 V
State Saved	Saved in instrument state
Min	-3.5V
Max	3.5V
Default Unit	V
<b>Backwards Compatibility SCPI</b>	:TRIGger[:SEquence]:EXTernal:LEVel For backward compatibility, the parameter EXTernal is mapped to EXTernal1
<b>Backwards Compatibility SCPI</b>	:TRIGger[:SEquence]:FRAMe:EXTernal1:LEVel
Initial S/W Revision	Prior to A.02.00

### Trig Slope

Controls the trigger polarity. It is set positive to trigger on a rising edge and negative to trigger on a falling edge.

Key Path	Trigger, External 1
<b>Remote Command</b>	:TRIGger[:SEquence]:EXTernal1:SLOPe POSitive NEGative :TRIGger[:SEquence]:EXTernal1:SLOPe?

<b>Example</b>	TRIG:EXT1:SLOP NEG
Couplings	This same slope is used in the Ext1 selection for the trigger source in the Trigger menu and for the period timer sync source (in the Trigger menu and in the Gate Source menu).
Preset	POSitive
State Saved	Saved in instrument state
<b>Backwards Compatibility SCPI</b>	:TRIGger[:SEquence]:EXTernal:SLOPe For backward compatibility, the parameter EXTernal is mapped to EXTernal1
<b>Backwards Compatibility SCPI</b>	:TRIGger[:SEquence]:FRAMe:EXTernal1:SLOPe
Backwards Compatibility Notes	The legacy :TRIGger[:SEquence]:SLOPe command affects the slopes for the VID, LINE, EXT1, EXT2, and RFB triggers.
Initial S/W Revision	Prior to A.02.00

### Zero Span Delay Comp On/Off

In zero span, there is a natural delay in the signal path, which comes from the RBW filter. This is usually desirable, as it allows you to trigger on events and also see those events, because the signal is delayed from the trigger event. However, in some cases it is desirable to eliminate this delay, so that trigger events line up exactly with the zero time point in zero span. You can use the Zero Span Delay Comp On/Off feature to enable or disable zero span delay compensation.

<b>Key Path</b>	Trigger, External 1
<b>Remote Command</b>	:TRIGger[:SEquence]:EXTernal1:DELay:COMPensation OFF ON 0 1 :TRIGger[:SEquence]:EXTernal1:DELay:COMPensation?
<b>Example</b>	TRIG:EXT1:DEL:COMP ON
Dependencies	No effect except in zero-span, but not locked out in nonzero spans. Blanked in modes that do not support zero-span measurements. If the SCPI command is sent when the key is blanked, an error is returned: -221, "Settings conflict; Feature not supported for this measurement" In analyzers shipping N9060A, this feature requires N9060A-7FP.
Preset	OFF
State Saved	Saved in instrument state
Initial S/W Revision	A.11.00

### External 2

Pressing this key, when it is not selected, selects an external input signal as the trigger. A new sweep/measurement will start when the external trigger condition is met using the external 2 input connector. The external trigger 2 input connector is on the rear panel.

Pressing this key, when it is already selected, accesses the external 2 trigger setup menu.



Key Path	Trigger
<b>Example</b>	TRIG:SOUR EXT2 Swept SA measurement TRIG:<meas>:SOUR EXT2 Measurements other than Swept SA
Dependencies	In some models, there is no second External input. In these models, the External 2 key is blanked and the EXTernal2 parameter will generate a "Hardware missing; Not available for this model number" message. Grayed out if in use by Point Trigger in the Source Setup menu. Forced to Free Run if already selected and Point Trigger is set to External 2.
State Saved	Saved in instrument state
Status Bits/OPC dependencies	The Status Operation Register bit 5 "Waiting for Trigger" is set at the same time as the Sweeping or Measuring bit is set. It is cleared when the trigger actually occurs (that is, after the trigger event occurs and all the applicable trigger criteria have been met). A corresponding pop-up message ("Waiting for trigger") is generated if no trigger signal appears after approximately 2 sec. This message goes away when a trigger signal appears.
Initial S/W Revision	Prior to A.02.00
Modified at S/W Revision	A.03.00

### Trigger Level

Sets the value where the external 2 trigger input will trigger a new sweep/measurement.

Key Path	Trigger, External 2
<b>Remote Command</b>	:TRIGger[:SEquence]:EXTernal2:LEVel :TRIGger[:SEquence]:EXTernal2:LEVel?
<b>Example</b>	TRIG:EXT2:LEV 1.1 V
Couplings	This same level is used for the Ext2 trigger source in the Trigger menu, for the Ext2 selection in the Periodic Timer sync source (in the Trigger menu and in the Gate Source menu), and also for the Ext2 selection in the Gate Source menu.
Preset	1.2 V
State Saved	Saved in instrument state
Min	-3.5V
Max	3.5V
Default Unit	V
<b>Backwards Compatibility SCPI</b>	:TRIGger[:SEquence]:FRAMe:EXTernal2:LEVel
Initial S/W Revision	Prior to A.02.00

### Trig Slope

Controls the trigger polarity. It is set positive to trigger on a rising edge and negative to trigger on a falling edge.

Key Path	Trigger, External 2
Remote Command	:TRIGger[:SEquence]:EXternal2:SLOPe POSitive NEGative :TRIGger[:SEquence]:EXternal2:SLOPe?
Example	TRIG:EXT2:SLOP NEG
Couplings	This same slope is used in the Ext2 selection for the trigger source in the Trigger menu and for the period timer sync source (in the Trigger menu and in the Gate Source menu).
Preset	POSitive
State Saved	Saved in instrument state
Backwards Compatibility SCPI	:TRIGger[:SEquence]:FRAMe:EXternal2:SLOPe
Backwards Compatibility Notes	The legacy :TRIGger[:SEquence]:SLOPe command affects the slopes for the VID, LINE, EXT1, EXT2, and RFB triggers.
Initial S/W Revision	Prior to A.02.00

### Zero Span Delay Comp On/Off

In zero span, there is a natural delay in the signal path, which comes from the RBW filter. This is usually desirable, as it allows you to trigger on events and also see those events, because the signal is delayed from the trigger event. However, in some cases it is desirable to eliminate this delay, so that trigger events line up exactly with the zero time point in zero span. You can use the Zero Span Delay Comp On/Off feature to enable or disable zero span delay compensation.

Key Path	Trigger, External 2
Remote Command	:TRIGger[:SEquence]:EXternal2:DELAy:COMPensation OFF ON 0 1 :TRIGger[:SEquence]:EXternal2:DELAy:COMPensation?
Example	TRIG:EXT2:DEL:COMP ON
Dependencies	No effect except in zero-span, but not locked out in nonzero spans. Blanked in modes that do not support zero-span measurements. If the SCPI command is sent when the key is blanked, an error is returned: -221, "Settings conflict; Feature not supported for this measurement" In analyzers shipping N9060A, this feature requires N9060A-7FP.
Preset	OFF
State Saved	Saved in instrument state
Initial S/W Revision	A.11.00

## RF Burst

Pressing this key, when it is not selected, selects the RF Burst as the trigger. A new sweep/measurement will start when an RF burst envelope signal is identified from the signal at the RF Input connector. Pressing this key, when it is already selected, accesses the RF Burst trigger setup menu.

In some models, a variety of burst trigger circuitry is available, resulting in various available burst trigger bandwidths. The analyzer automatically chooses the appropriate trigger path based on the hardware configuration and other settings of the analyzer.

Key Path	Trigger
<b>Example</b>	TRIG:SOUR RFB Swept SA measurement TRIG:<meas>:SOUR RFB Measurements other than Swept SA
State Saved	Saved in instrument state
Status Bits/OPC dependencies	The Status Operation Register bit 5 "Waiting for Trigger" is set at the same time as the Sweeping or Measuring bit is set. It is cleared when the trigger actually occurs (that is, after the trigger event occurs and all the applicable trigger criteria have been met). A corresponding pop-up message ("Waiting for trigger") is generated if no trigger signal appears after approximately 2 sec. This message goes away when a trigger signal appears.
Backwards Compatibility Notes	The legacy command: :TRIGger[:SEQuence]:RFBurst:FSElectivity[:STATe] OFF ON 0 1 is not supported in the X-Series, as the hardware to do Frequency Selective burst triggers does not exist in X-Series.
Initial S/W Revision	Prior to A.02.00
Modified at S/W Revision	A.04.00

## Absolute Trigger Level

Sets the absolute trigger level for the RF burst envelope.

When using the External Mixing path, the Absolute Trigger Level is uncalibrated because the factory default was set to accommodate the expected IF levels for the RF path.

Key Path	Trigger, RF Burst
Scope	Meas Global
<b>Remote Command</b>	:TRIGger[:SEQuence]:RFBurst:LEVel:ABSolute <amp1> :TRIGger[:SEQuence]:RFBurst:LEVel:ABSolute?
<b>Example</b>	TRIG:RFB:LEV:ABS 10 dBm sets the trigger level of the RF burst envelope signal to the absolute level of 10 dBm
Notes	Sending this command does not switch the setting from relative to absolute; to switch it you need to send the :TRIGger[:SEQuence]:RFBurst:LEVel:TYPE command, below.  Amplitude Corrections are not taken into account by the Absolute Trigger Level. For example, if you have given yourself effective gain with an amplitude correction factor, the Absolute Trigger will not fire until you have set the trigger level that far below the displayed signal level, rather than simply to

	the displayed signal level. This is only true for Amplitude Corrections, not External Gain or Ref Level Offset functions. If mode is Bluetooth, the default value is -50 dBm.
Couplings	This same level is used for the RF Burst trigger source in the Trigger menu, for the RF Burst selection in the Periodic Timer sync source (in the Trigger menu and in the Gate Source menu), and also for the RF Burst selection in the Gate Source menu
Preset	-20 dBm
State Saved	Saved in instrument state
Min	-200 dBm
Max	100 dBm
Default Unit	depends on the current selected Y-Axis unit
<b>Backwards Compatibility SCPI</b>	:TRIGger[:SEquence]:FRAME:RFBurst:LEVel:ABSolute
Initial S/W Revision	Prior to A.02.00
Modified at S/W Revision	A.04.00

Key Path	Trigger, RF Burst
<b>Remote Command</b>	:TRIGger[:SEquence]:RFBurst:LEVel:TYPE ABSolute RELative :TRIGger[:SEquence]:RFBurst:LEVel:TYPE?
<b>Example</b>	TRIG:RFB:LEV:TYPE REL sets the trigger level type of the RF burst trigger to Relative.
Preset	ABSolute
State Saved	Saved in instrument state
Initial S/W Revision	Prior to A.02.00
Modified at S/W Revision	A.04.00

### Relative Trigger Level

Sets the relative trigger level for the RF burst envelope.

In some models, the relative burst trigger function is implemented in hardware. In other models, without the advanced triggering hardware required, the relative burst trigger function is implemented in software in some measurements, and is unavailable in other measurements.

When implemented in software, the relative RF Burst trigger function is implemented as follows:

1. The measurement starts with the absolute RF Burst trigger setting. If it cannot get a trigger with that level, auto trigger fires and the acquisition starts anyway. After the acquisition, the measurement searches for the peak in the acquired waveform and saves it.

2. Now, in the next cycle of the measurement, the measurement determines a new absolute RF Burst level based on the peak value from the first measurement and the Relative RF Burst Trigger Level (always 0 or negative dB) set by the user. The following formula is used:
  3. absolute RF Burst level = peak level of the previous acquisition + relative RF Burst level
  4. If the new absolute RF Burst level differs from the previous by more than 0.5 dB, the new level is sent to the hardware; otherwise it is not updated (to avoid slowing down the acquisition)
- Steps 2 and 3 repeat for subsequent measurements.

Key Path	Trigger, RF Burst
Scope	Meas Global
<b>Remote Command</b>	:TRIGger[:SEquence]:RFBurst:LEVel:RELative <rel_ampl> :TRIGger[:SEquence]:RFBurst:LEVel:RELative?
<b>Example</b>	TRIG:RFB:LEV:REL -10 dB sets the trigger level of the RF burst envelope signal to the relative level of -10 dB
Notes	Sending this command does not switch the setting from absolute to relative; to switch it you need to send the :TRIGger[:SEquence]:RFBurst:LEVel:TYPE command, above. The relative trigger level is not available in some measurements. In those measurements the RELative parameter, and the :TRIGger[:SEquence]:RFBurst:LEVel:TYPE command (above), will generate an error if sent.
Dependencies	This key is grayed out and Absolute Trigger Level selected if the required hardware is not present in your analyzer and the current measurement does not support Relative triggering.
Preset	-6 dB GSM: -25 dB
State Saved	Saved in instrument state
Min	-45 dB
Max	0 dB
Default Unit	dB or dBc
<b>Backwards Compatibility SCPI</b>	:TRIGger[:SEquence]:RFBurst:LEVel This legacy command is aliased to :TRIGger[:SEquence]:RFBurst:LEVel:RELative because the PSA had ONLY relative burst triggering
Initial S/W Revision	Prior to A.02.00
Modified at S/W Revision	A.04.00

### Trigger Slope

It is set positive to trigger on a rising edge and negative to trigger on a falling edge.

Key Path	Trigger, RF Burst
<b>Remote Command</b>	:TRIGger[:SEquence]:RFBurst:SLOPe Positive NEGative :TRIGger[:SEquence]:RFBurst:SLOPe?

<b>Example</b>	TRIG:RFB:SLOP NEG
Couplings	This same slope is used in the RF Burst selection for the trigger source in the Trigger menu and for the period timer sync source (in the Trigger menu and in the Gate Source menu).
Preset	POSitive
State Saved	Saved in instrument state
<b>Backwards Compatibility SCPI</b>	:TRIGger[:SEQuence]:FRAMe:RFBurst:SLOPe
Backwards Compatibility Notes	The legacy :TRIGger[:SEQuence]:SLOPe command affects the slopes for the VID, LINE, EXT1, EXT2, and RFB triggers.
Initial S/W Revision	Prior to A.02.00

### Periodic Timer (Frame Trigger)

Pressing this key, when it is not selected, selects the internal periodic timer signal as the trigger. Triggering occurrences are set by the **Period** parameter, which is modified by the **Sync Source** and **Offset**. Pressing this key, when it is already selected, accesses the periodic timer trigger setup functions.

If you do not have a sync source selected (it is Off), then the internal timer will not be synchronized with any external timing events.

<b>Key Path</b>	Trigger
<b>Example</b>	TRIG:SOUR FRAM Swept SA measurement TRIG:<meas>:SOUR FRAM Measurements other than Swept SA
State Saved	Saved in instrument state
Readback	[Sync: <value of Sync Source>], for example, [Sync: External 1]
Status Bits/OPC dependencies	The Status Operation Register bit 5 "Waiting for Trigger" is set at the same time as the Sweeping or Measuring bit is set. It is cleared when the trigger actually occurs (that is, after the trigger event occurs and all the applicable trigger criteria have been met). A corresponding pop-up message ("Waiting for trigger") is generated if no trigger signal appears after approximately 2 sec. This message goes away when a trigger signal appears.
Initial S/W Revision	Prior to A.02.00

### Periodic Timer Triggering:

This feature selects the internal periodic timer signal as the trigger. Trigger occurrences are set by the **Periodic Timer** parameter, which is modified by the **Sync Source** and **Offset**.

The figure below shows the action of the periodic timer trigger. Before reviewing the figure, we'll explain some uses for the periodic trigger.

A common application is measuring periodic burst RF signals for which a trigger signal is not easily available. For example, we might be measuring a TDMA radio which bursts every 20 ms. Let's assume that the 20 ms period is very consistent. Let's also assume that we do not have an external trigger source

available that is synchronized with the period, and that the signal-to-noise ratio of the signal is not high enough to provide a clean RF burst trigger at all of the analysis frequencies. For example, we might want to measure spurious transmissions at an offset from the carrier that is larger than the bandwidth of the RF burst trigger. In this application, we can set the Periodic Timer to a 20.00 ms period and adjust the offset from that timer to position our trigger just where we want it. If we find that the 20.00 ms is not exactly right, we can adjust the period slightly to minimize the drift between the period timer and the signal to be measured.

A second way to use this feature would be to use **Sync Source** temporarily, instead of **Offset**. In this case, we might tune to the signal in a narrow span and use the RF Burst trigger to synchronize the periodic timer. Then we would turn the sync source off so that it would not miss-trigger. Miss-triggering can occur when we are tuned so far away from the RF burst trigger that it is no longer reliable.

A third example would be to synchronize to a signal that has a reference time element of much longer period than the period of interest. In some CDMA applications, it is useful to look at signals with a short periodicity, by synchronizing that periodicity to the "even-second clock" edge that happens every two seconds. Thus, we could connect the even-second clock trigger to Ext1 and use then Ext1 as the sync source for the periodic timer.

The figure below illustrates this third example. The top trace represents the even-second clock. It causes the periodic timer to synchronize with the leading edge shown. The analyzer trigger occurs at a time delayed by the accumulated offset from the period trigger event. The periodic timer continues to run, and triggers continue to occur, with a periodicity determined by the analyzer time base. The timer output (labeled "late event") will drift away from its ideal time due to imperfect matching between the time base of the signal being measured and the time base of the analyzer, and also because of imperfect setting of the period parameter. But the synchronization is restored on the next even-second clock event. ("Accumulated offset" is described in the in the **Offset** function section.)

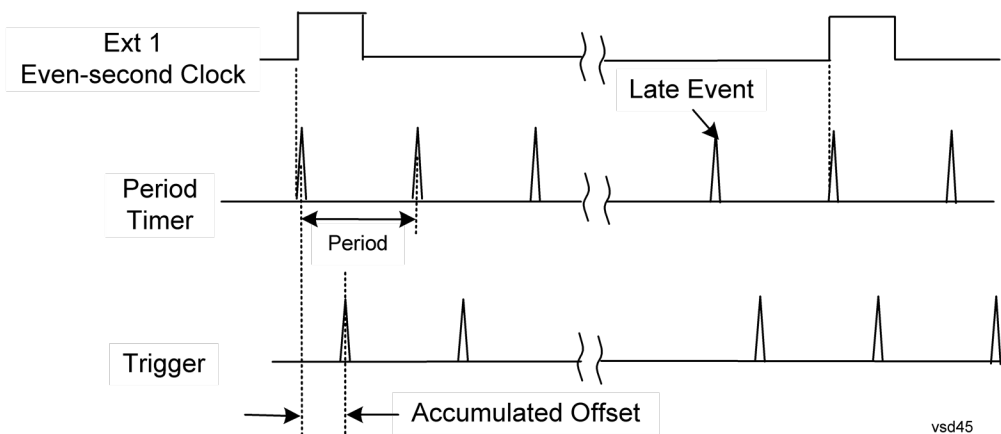

### Period

Sets the period of the internal periodic timer clock. For digital communications signals, this is usually set to the frame period of your current input signal. In the case that sync source is not set to OFF, and the external sync source rate is changed for some reason, the periodic timer is synchronized at the every external synchronization pulse by resetting the internal state of the timer circuit.

<b>Key Path</b>	Trigger, Periodic Timer
<b>Remote Command</b>	:TRIGger[:SEquence]:FRAMe:PERiod <time>

	:TRIGger[:SEquence]:FRAMe:PERiod?
<b>Example</b>	TRIG:FRAM:PER 100 ms
<b>Dependencies</b>	The invalid data indicator turns on when the period is changed, until the next sweep/measurement completes.
<b>Couplings</b>	The same period is used in the Gate Source selection of the period timer.
<b>Preset</b>	20 ms GSM: 4.615383
<b>State Saved</b>	Saved in instrument state
<b>Min</b>	100.000 ns
<b>Max</b>	559.0000 ms
<b>Default Unit</b>	S
<b>Initial S/W Revision</b>	Prior to A.02.00

### Offset

Adjusts the accumulated offset between the periodic timer events and the trigger event. Adjusting the accumulated offset is different than setting an offset, and requires explanation.

The periodic timer is usually not synchronized with any external events, so the timing of its output events has no absolute meaning. Since the timing relative to external events (RF signals) is important, you need to be able to adjust (offset) it. However, you have no direct way to see when the periodic timer events occur. All that you can see is the trigger timing. When you want to adjust the trigger timing, you will be changing the internal offset between the periodic timer events and the trigger event. Because the absolute value of that internal offset is unknown, we will just call that the accumulated offset. Whenever the Offset parameter is changed, you are changing that accumulated offset. You can reset the displayed offset using Reset Offset Display. Changing the display does not change the value of the accumulated offset, and you can still make additional changes to accumulated offset.

To avoid ambiguity, we define that an increase in the "offset" parameter, either from the knob or the SCPI adjust command, serves to delay the timing of the trigger event.

<b>Key Path</b>	Trigger, Periodic Timer
<b>Remote Command</b>	:TRIGger[:SEquence]:FRAMe:OFFSet <time> :TRIGger[:SEquence]:FRAMe:OFFSet?
<b>Example</b>	TRIG:FRAM:OFFS 1.2 ms
<b>Notes</b>	The front panel interface (for example, the knob), and this command, adjust the accumulated offset, which is shown on the active function display. However, the actual amount sent to the hardware each time the offset is updated is the delta value, that is, the current accumulated offset value minus the previous accumulated offset value. Note that the accumulated offset value is essentially arbitrary; it represents the accumulated offset from the last time the offset was zeroed (with the Reset Offset Display key).  Note that this command does not change the period of the trigger waveform. Note also that Offset is used only when the sync source is set to OFF, otherwise delay is used, see section " <a href="#">Trig Delay</a> " on <a href="#">page 275</a> .



	An increase in the "offset" parameter, either from the knob or the SCPI adjust command, serves to delay the timing of the trigger event.
Notes	When the SCPI command is sent the value shown on the key (and the Active Function, if this happens to be the active function) is updated with the new value. However, the actual amount sent to the hardware is the delta value, that is, the current accumulated offset value minus the previous accumulated offset value. The SCPI query simply returns the value currently showing on the key.
Dependencies	The invalid data indicator turns on when the offset is changed, until the next sweep/measurement completes.
Couplings	The same offset is used in the Gate Source selection of the period timer.
Preset	0 s
State Saved	Saved in instrument state
Min	-10.000 s
Max	10.000 s
Default Unit	S
Initial S/W Revision	Prior to A.02.00

#### Offset Adjust (Remote Command Only)

This remote command does not work at all like the related front panel keys. This command lets you advance the phase of the frame trigger by the amount you specify.

It does not change the period of the trigger waveform. If the command is sent multiple times, it advances the phase of the frame trigger an additional amount each time it is sent. Negative numbers are permitted.

<b>Remote Command</b>	:TRIGger[:SEquence]:FRAMe:ADJust <time>
<b>Example</b>	TRIG:FRAM:ADJ 1.2 ms
Notes	Note also that Offset is used only when the sync source is set to OFF, otherwise delay is used, see section " <a href="#">Trig Delay</a> " on page 275 An increase in the "offset" parameter, either from the knob or the SCPI adjust command, serves to delay the timing of the trigger event.
Notes	The front panel interface (for example, the knob) and the :TRIG:FRAM:OFFS command adjust the accumulated offset, which is shown on the active function display. However, the actual amount sent to the hardware is the delta value, that is, the current offset value minus the previous offset value. When the SCPI command is sent the value shown on the key (and the Active Function, if this happens to be the active function) is updated by increasing it (or decreasing it if the value sent is negative) by the amount specified in the SCPI command. This is a "command only" SCPI command, with no query.
Dependencies	The invalid data indicator turns on when the offset is changed, until the next sweep/measurement completes.
Couplings	The same offset is used in the Gate Source selection of the period timer.
Preset	0 s

State Saved	Saved in instrument state
Min	-10.000 s
Max	10.000 s
Default Unit	S
Initial S/W Revision	Prior to A.02.00

### Reset Offset Display

Resets the value of the periodic trigger offset display setting to 0.0 seconds. The current displayed trigger location may include an offset value defined with the Offset key. Pressing this key redefines the currently displayed trigger location as the new trigger point that is 0.0 s offset. The Offset key can then be used to add offset relative to this new timing.

Key Path	Trigger, Periodic Timer
Remote Command	:TRIGger[:SEquence]:FRAMe:OFFSet:DISPlay:RESet
Example	TRIG:FRAM:OFFS:DISP:RES
Initial S/W Revision	Prior to A.02.00

### Sync Source

Selects a signal source for you to synchronize your periodic timer trigger to, otherwise you are triggering at some arbitrary location in the frame. Synchronization reduces the precision requirements on the setting of the period.

For convenience you may adjust the level and slope of the selected sync source in a conditional branch setup menu accessed from the Sync Source menu. Note that these settings match those in the **Trigger** and **Gate Source** menus; that is, each trigger source has only one value of level and slope, regardless of which menu it is accessed from.

Key Path	Trigger, Periodic Timer
Remote Command	:TRIGger[:SEquence]:FRAMe:SYNC EXTernal1   EXTernal2   RFBurst   OFF :TRIGger[:SEquence]:FRAMe:SYNC?
Example	TRIG:FRAM:SYNC EXT2
Dependencies	In some models, there is no second External input. In these models, the External 2 key is blanked and the EXTernal2 parameter will generate a "Hardware missing; Not available for this model number" message.
Preset	Off GSM/EDGE, MSR,LTE,LTETDD: RFBurst
State Saved	Saved in instrument state
Readback	The current setting is read back to this key and it is also Readback to the previous Periodic Timer trigger key.

<b>Backwards Compatibility SCPI</b>	:TRIGger[:SEquence]:FRAMe:SYNC EXTernal
Initial S/W Revision	Prior to A.02.00
Modified at S/W Revision	A.03.00, A.14.00

#### Off

Turns off the sync source for your periodic trigger. With the sync source off, the timing will drift unless the signal source frequency is locked to the analyzer frequency reference.

<b>Key Path</b>	Trigger, Periodic Timer, Sync Source
<b>Example</b>	TRIG:FRAM:SYNC OFF
<b>Readback</b>	Off
<b>Initial S/W Revision</b>	Prior to A.02.00

#### External 1

Pressing this key, when it is not selected, selects an external input signal as the trigger. A new sweep/measurement will start when the external trigger condition is met using the external 1 input connector on the rear panel.

Pressing this key, when it is already selected, accesses the external 1 trigger setup menu.

<b>Key Path</b>	Trigger
<b>Example</b>	TRIG:SOUR EXT1 Swept SA measurement TRIG:<meas>:SOUR EXT1 Measurements other than Swept SA
<b>Dependencies</b>	Grayed out if in use by Point Trigger in the Source Setup menu. Forced to Free Run if already selected and Point Trigger is set to External 1.
<b>State Saved</b>	Saved in instrument state
<b>Status Bits/OPC dependencies</b>	The Status Operation Register bit 5 "Waiting for Trigger" is set at the same time as the Sweeping or Measuring bit is set. It is cleared when the trigger actually occurs (that is, after the trigger event occurs and all the applicable trigger criteria have been met). A corresponding pop-up message ("Waiting for trigger") is generated if no trigger signal appears after approximately 2 sec. This message goes away when a trigger signal appears.
<b>Initial S/W Revision</b>	Prior to A.02.00

#### Trigger Level

Sets the value where the external 1 trigger input will trigger a new sweep/measurement.

Key Path	Trigger, External 1
<b>Remote Command</b>	:TRIGger[:SEquence]:EXTernal1:LEVel <level> :TRIGger[:SEquence]:EXTernal1:LEVel?
<b>Example</b>	TRIG:EXT1:LEV 0.4 V
Couplings	This same level is used for the Ext1 trigger source in the Trigger menu, for the Ext1 selection in the Periodic Timer sync source (in the Trigger menu and in the Gate Source menu), and also for the Ext1 selection in the Gate Source menu.
Preset	1.2 V
State Saved	Saved in instrument state
Min	-3.5V
Max	3.5V
Default Unit	V
<b>Backwards Compatibility SCPI</b>	:TRIGger[:SEquence]:EXTernal:LEVel For backward compatibility, the parameter EXTernal is mapped to EXTernal1
<b>Backwards Compatibility SCPI</b>	:TRIGger[:SEquence]:FRame:EXTernal1:LEVel
Initial S/W Revision	Prior to A.02.00

### Trig Slope

Controls the trigger polarity. It is set positive to trigger on a rising edge and negative to trigger on a falling edge.

Key Path	Trigger, External 1
<b>Remote Command</b>	:TRIGger[:SEquence]:EXTernal1:SLOPe POSitive NEGative :TRIGger[:SEquence]:EXTernal1:SLOPe?
<b>Example</b>	TRIG:EXT1:SLOP NEG
Couplings	This same slope is used in the Ext1 selection for the trigger source in the Trigger menu and for the period timer sync source (in the Trigger menu and in the Gate Source menu).
Preset	POSitive
State Saved	Saved in instrument state
<b>Backwards Compatibility SCPI</b>	:TRIGger[:SEquence]:EXTernal:SLOPe For backward compatibility, the parameter EXTernal is mapped to EXTernal1
<b>Backwards Compatibility SCPI</b>	:TRIGger[:SEquence]:FRame:EXTernal1:SLOPe
Backwards Compatibility Notes	The legacy :TRIGger[:SEquence]:SLOPe command affects the slopes for the VID, LINE, EXT1, EXT2, and RFB triggers.
Initial S/W Revision	Prior to A.02.00

## External 2

Pressing this key, when it is not selected, selects an external input signal as the trigger. A new sweep/measurement will start when the external trigger condition is met using the external 2 input connector. The external trigger 2 input connector is on the rear panel.

Pressing this key, when it is already selected, accesses the external 2 trigger setup menu.

Key Path	Trigger
<b>Example</b>	TRIG:SOUR EXT2 Swept SA measurement TRIG:<meas>:SOUR EXT2 Measurements other than Swept SA
Dependencies	In some models, there is no second External input. In these models, the External 2 key is blanked and the EXTERNAL2 parameter will generate a "Hardware missing; Not available for this model number" message. Grayed out if in use by Point Trigger in the Source Setup menu. Forced to Free Run if already selected and Point Trigger is set to External 2.
State Saved	Saved in instrument state
Status Bits/OPC dependencies	The Status Operation Register bit 5 "Waiting for Trigger" is set at the same time as the Sweeping or Measuring bit is set. It is cleared when the trigger actually occurs (that is, after the trigger event occurs and all the applicable trigger criteria have been met). A corresponding pop-up message ("Waiting for trigger") is generated if no trigger signal appears after approximately 2 sec. This message goes away when a trigger signal appears.
Initial S/W Revision	Prior to A.02.00
Modified at S/W Revision	A.03.00

## Trigger Level

Sets the value where the external 2 trigger input will trigger a new sweep/measurement.

Key Path	Trigger, External 2
<b>Remote Command</b>	:TRIGger[:SEquence]:EXTernal2:LEVel :TRIGger[:SEquence]:EXTernal2:LEVel?
<b>Example</b>	TRIG:EXT2:LEV 1.1 V
Couplings	This same level is used for the Ext2 trigger source in the Trigger menu, for the Ext2 selection in the Periodic Timer sync source (in the Trigger menu and in the Gate Source menu), and also for the Ext2 selection in the Gate Source menu.
Preset	1.2 V
State Saved	Saved in instrument state
Min	-3.5V
Max	

	3.5V
Default Unit	V
<b>Backwards Compatibility SCPI</b>	:TRIGger[:SEquence]:FRAMe:EXTernal2:LEVel
Initial S/W Revision	Prior to A.02.00

### Trig Slope

Controls the trigger polarity. It is set positive to trigger on a rising edge and negative to trigger on a falling edge.

Key Path	Trigger, External 2
<b>Remote Command</b>	:TRIGger[:SEquence]:EXTernal2:SLOPe POSitive NEGative :TRIGger[:SEquence]:EXTernal2:SLOPe?
<b>Example</b>	TRIG:EXT2:SLOP NEG
Couplings	This same slope is used in the Ext2 selection for the trigger source in the Trigger menu and for the period timer sync source (in the Trigger menu and in the Gate Source menu).
Preset	POSitive
State Saved	Saved in instrument state
<b>Backwards Compatibility SCPI</b>	:TRIGger[:SEquence]:FRAMe:EXTernal2:SLOPe
Backwards Compatibility Notes	The legacy :TRIGger[:SEquence]:SLOPe command affects the slopes for the VID, LINE, EXT1, EXT2, and RFB triggers.
Initial S/W Revision	Prior to A.02.00

### RF Burst

Pressing this key, when it is not selected, selects the RF Burst as the trigger. A new sweep/measurement will start when an RF burst envelope signal is identified from the signal at the RF Input connector. Pressing this key, when it is already selected, accesses the RF Burst trigger setup menu.

In some models, a variety of burst trigger circuitry is available, resulting in various available burst trigger bandwidths. The analyzer automatically chooses the appropriate trigger path based on the hardware configuration and other settings of the analyzer.

Key Path	Trigger
<b>Example</b>	TRIG:SOUR RFB Swept SA measurement TRIG:<meas>:SOUR RFB Measurements other than Swept SA
State Saved	Saved in instrument state
Status Bits/OPC dependencies	The Status Operation Register bit 5 "Waiting for Trigger" is set at the same time as the Sweeping or Measuring bit is set. It is cleared when the trigger actually occurs (that is, after the trigger event

	occurs and all the applicable trigger criteria have been met). A corresponding pop-up message ("Waiting for trigger") is generated if no trigger signal appears after approximately 2 sec. This message goes away when a trigger signal appears.
Backwards Compatibility Notes	The legacy command: :TRIGger[:SEquence]:RFBurst:FSElectivity[:STATe] OFF ON 0 1 is not supported in the X-Series, as the hardware to do Frequency Selective burst triggers does not exist in X-Series.
Initial S/W Revision	Prior to A.02.00
Modified at S/W Revision	A.04.00

### Absolute Trigger Level

Sets the absolute trigger level for the RF burst envelope.

When using the External Mixing path, the Absolute Trigger Level is uncalibrated because the factory default was set to accommodate the expected IF levels for the RF path.

Key Path	Trigger, RF Burst
Scope	Meas Global
<b>Remote Command</b>	:TRIGger[:SEquence]:RFBurst:LEVel:ABSolute <ampl> :TRIGger[:SEquence]:RFBurst:LEVel:ABSolute?
<b>Example</b>	TRIG:RFB:LEV:ABS 10 dBm sets the trigger level of the RF burst envelope signal to the absolute level of 10 dBm
Notes	Sending this command does not switch the setting from relative to absolute; to switch it you need to send the :TRIGger[:SEquence]:RFBurst:LEVel:TYPE command, below.  Amplitude Corrections are not taken into account by the Absolute Trigger Level. For example, if you have given yourself effective gain with an amplitude correction factor, the Absolute Trigger will not fire until you have set the trigger level that far below the displayed signal level, rather than simply to the displayed signal level. This is only true for Amplitude Corrections, not External Gain or Ref Level Offset functions.  If mode is Bluetooth, the default value is -50 dBm.
Couplings	This same level is used for the RF Burst trigger source in the Trigger menu, for the RF Burst selection in the Periodic Timer sync source (in the Trigger menu and in the Gate Source menu), and also for the RF Burst selection in the Gate Source menu
Preset	-20 dBm
State Saved	Saved in instrument state
Min	-200 dBm
Max	100 dBm
Default Unit	depends on the current selected Y-Axis unit
<b>Backwards Compatibility SCPI</b>	:TRIGger[:SEquence]:FRAMe:RFBurst:LEVel:ABSolute
Initial S/W Revision	Prior to A.02.00
Modified at S/W Revision	A.04.00

Key Path	Trigger, RF Burst
Remote Command	:TRIGger[:SEquence]:RFBurst:LEVel:TYPE ABSolute RELative :TRIGger[:SEquence]:RFBurst:LEVel:TYPE?
Example	TRIG:RFB:LEV:TYPE REL sets the trigger level type of the RF burst trigger to Relative.
Preset	ABSolute
State Saved	Saved in instrument state
Initial S/W Revision	Prior to A.02.00
Modified at S/W Revision	A.04.00

### Trigger Slope

It is set positive to trigger on a rising edge and negative to trigger on a falling edge.

Key Path	Trigger, RF Burst
Remote Command	:TRIGger[:SEquence]:RFBurst:SLOPe POSitive NEGative :TRIGger[:SEquence]:RFBurst:SLOPe?
Example	TRIG:RFB:SLOP NEG
Couplings	This same slope is used in the RF Burst selection for the trigger source in the Trigger menu and for the period timer sync source (in the Trigger menu and in the Gate Source menu).
Preset	POSitive
State Saved	Saved in instrument state
Backwards Compatibility SCPI	:TRIGger[:SEquence]:FRAME:RFBurst:SLOPe
Backwards Compatibility Notes	The legacy :TRIGger[:SEquence]:SLOPe command affects the slopes for the VID, LINE, EXT1, EXT2, and RFB triggers.
Initial S/W Revision	Prior to A.02.00

### Sync Holdoff

Sync Holdoff specifies the duration that the sync source signal must be kept false before the transition to true to be recognized as the sync timing. The periodic timer phase is aligned when the sync source signal becomes true, after the Holdoff time is satisfied.

A holdoff of 2 ms will work with most WiMAX signals, but there may be cases where the burst off duration is less than 1 ms and this value will need to be changed.

Key Path	Trigger, Periodic Timer
Remote Command	:TRIGger[:SEquence]:FRAME:SYNC:HOLDoff <time> :TRIGger[:SEquence]:FRAME:SYNC:HOLDoff?



	:TRIGger[:SEquence]:FRAMe:SYNC:HOLDoff:STATe OFF ON 0 1
	:TRIGger[:SEquence]:FRAMe:SYNC:HOLDoff:STATe?
Preset	On, 1.000 ms
State Saved	Saved in instrument state
Min	0 ms
Max	+500 ms
Default Unit	s
Initial S/W Revision	Prior to A.02.00

### Auto/Holdoff

Opens up a menu that lets you adjust Auto Trigger and Trigger Holdoff parameters

Key Path	Trigger
Readback line	Displays a summary of the Auto Trig and Holdoff settings, in square brackets First line: Auto Off or Auto On Second Line: "HldP" followed by: <ul style="list-style-type: none"> <li>• If Holdoff is Off, readback Off</li> <li>• If Holdoff On and Type = Normal, readback value</li> <li>• If Holdoff On and Type = Above, readback value followed by AL</li> <li>• If Holdoff On and Type = Below, readback value followed by BL</li> <li>• If Holdoff Type selection is not supported by the current measurement, Holdoff Type is always Normal</li> </ul>
Initial S/W Revision	A.02.00

### Auto Trig

Sets the time that the analyzer will wait for the trigger conditions to be met. If they are not met after that much time, then the analyzer is triggered anyway.

Key Path	Trigger, Auto/Holdoff
<b>Remote Command</b>	:TRIGger[:SEquence]:ATRigger <time> :TRIGger[:SEquence]:ATRigger? :TRIGger[:SEquence]:ATRigger:STATe OFF ON 0 1 :TRIGger[:SEquence]:ATRigger:STATe?
<b>Example</b>	TRIG:ATR:STAT ON TRIG:ATR 100 ms
Notes	The "time that the analyzer will wait" starts when the analyzer is ready for a trigger, which may be hundreds of ms after the data acquisition for a sweep is done. The "time" ends when the trigger condition is satisfied, not when the delay ends.

Preset	Off, 100 ms
State Saved	Saved in instrument state
Min	1 ms
Max	100 s
Default Unit	s
Initial S/W Revision	Prior to A.02.00

### Trig Holdoff

Sets the holdoff time between triggers. When the trigger condition is satisfied, the trigger occurs, the delay begins, and the holdoff time begins. New trigger conditions will be ignored until the holdoff time expires. For a free-running trigger, the holdoff value is the minimum time between triggers.

Key Path	Trigger, Auto/Holdoff
<b>Remote Command</b>	:TRIGger[:SEquence]:HOLDoff <time> :TRIGger[:SEquence]:HOLDoff? :TRIGger[:SEquence]:HOLDoff:STATe OFF ON 0 1 :TRIGger[:SEquence]:HOLDoff:STATe?
<b>Example</b>	TRIG:HOLD:STAT ON TRIG:HOLD 100 ms
Dependencies	Unavailable if the selected Input is BBIQ. If this is the case, the key is grayed out if it is pressed the informational message "Feature not supported for this Input" is displayed. If the SCPI command is sent, the error "Settings conflict; Feature not supported for this Input" is generated.
Preset	Off, 100 ms
State Saved	Saved in instrument state
Min	0 s
Max	0.5 s
Default Unit	s
Initial S/W Revision	Prior to A.02.00

### Gate Preset (Remote Command Only)

Presets the time-gated spectrum analysis capability.

This command sets gate parameter values to the ESA preset values, as follows:

Gate delay = 1 us

Gate length = 1 us

<b>Remote Command</b>	[:SENSe]:SWEep:TIME:GATE:PRESet ESA Compatibility
Initial S/W Revision	Prior to A.02.00

### Gate Level (Remote Command Only)

Sets the gate input transition point level for the external TRIGGER inputs on the front and rear panel. This is a legacy command for PSA compatibility. It is simply an alias to the equivalent trigger level command.

<b>Remote Command</b>	<code>[ :SENSe ] :SWEep:EGATe:EXTeRnal [1]  2:LEVel &lt;voltage&gt;</code> <code>[ :SENSe ] :SWEep:EGATe:EXTeRnal [1]  2:LEVel?</code>
<b>Notes</b>	This command is simply an alias to <code>:TRIGger[:SEQuence]:EXTeRnal[1] 2:LEVel</code> For details refer
<b>Initial S/W Revision</b>	Prior to A.02.00

### Gate Polarity (Remote Command Only)

Sets the polarity for the gate signal. This setup is now done using the gate trigger's slope setting.

When Positive (Pos) is selected, a positive-going edge (Edge) or a high voltage (Level) will satisfy the gate condition, after the delay set with the Gate Delay key. When Negative (Neg) is selected, a negative-going edge (Edge) or a low voltage (Level) will satisfy the gate condition after the delay.

<b>Remote Command</b>	<code>[ :SENSe ] :SWEep:EGATe:POLarity NEGative POSitive</code> <code>[ :SENSe ] :SWEep:EGATe:POLarity?</code>
<b>Example</b>	<code>SWE:EGAT:POL NEG</code> <code>SWE:EGAT:POL?</code>
<b>Preset</b>	POSitive
<b>State Saved</b>	Saved in instrument state
<b>Backwards Compatibility SCPI</b>	<code>[ :SENSe ] :SWEep:TIME:GATE:POLarity</code> ESA compatibility
<b>Initial S/W Revision</b>	Prior to A.02.00

<b>Remote Command</b>	<code>[ :SENSe ] :SWEep:TIME:GATE:LEVel HIGH LOW</code> <code>[ :SENSe ] :SWEep:TIME:GATE:LEVel?</code> ESA compatibility
<b>Preset</b>	HIGH
<b>Initial S/W Revision</b>	Prior to A.02.00

## System

See "[System](#)" on page 184

## Trace/Detector

Accesses a menu of functions that enable you to control trace and detector for the current measurement.

Key Path	Front-panel key
Initial S/W Revision	Prior to A.02.00

### Trace Type

Allows you to select the type of trace for the current measurement. The menu contains a 1-of-N selection of the trace type (Clear Write, Average, Max Hold, Min Hold).

Key Path	Trace/Detector
Mode	SA, WCDMA, C2K, WIMAX OFDMA, TD-SCDMA, 1xEVDO, DTMB (CTTB), DVB-T/H, ISDB-T, CMMB, LTE, LTE-TDD, Digital Cable TV, WLAN, MSR, LTEAFDD, LTEATDD
Remote Command	:TRACe:SEMAsk:TYPE WRITe AVERAge MAXHold MINHold :TRACe:SEMAsk:TYPE?
Example	TRAC:SEM:TYPE MINH TRAC:SEM:TYPE?
Notes	WRITe = Clear Write AVERAge = Average MAXHold = Maximum Hold MINHold = Minimum Hold
Couplings	When Detector setting is "Auto" ([:SENSe]:SEMAsk:DETEctor:AUTO?), Detector ([:SENSe]:SEMAsk:DETEctor[:FUNCTion]?) switches aligning with the switch of this parameter: "NORMal" with WRITe (Clear Write), "AVERAge" with AVERAge, "POSitive (peak)" with MAXHold, and "NEGative (peak)" with MINHold.
Preset	AVERAge
State Saved	Saved in instrument state.
Range	WRITe AVERAge MAXHold MINHold
Initial S/W Revision	Prior to A.02.00
Modified at S/W Revision	A.02.00, A.03.00

### Chan Detector

Accesses a menu of functions that enable you to control the detectors for reference channel. The following choices are available:

- Auto—the detector selected depends on marker functions, trace functions, average type, and the trace averaging function.
- Normal—the detector determines the peak of the CW-like signals, and it yields alternating maximums and minimums of noise-like signals. This is also referred to as Rosenfell detection.

- Average—the detector determines the average of the signal within the sweep points. The averaging method depends upon the Average Type selection (voltage, power or log scales).
- Peak—the detector determines the maximum of the signal within the sweep points.
- Sample—the detector indicates the instantaneous level of the signal at the center of the sweep points represented by each display point.
- Negative Peak—the detector determines the minimum of the signal within the sweep points.

Key Path	Trace/Detector
Initial S/W Revision	Prior to A.02.00

### Chan Detector Auto

Sets the detector to the default detection mode for the reference channel. This mode is dependent upon the current reference channel conditions.

Key Path	Trace/Detector
Mode	SA, WCDMA, C2K, WIMAX OFDMA, TD-SCDMA, 1xEVDO, DTMB (CTTB), DVB-T/H, ISDB-T, CMMB, LTE, LTETDD, Digital Cable TV, WLAN, MSR, LTEAFDD, LTEATDD
Remote Command	<code>[ :SENSe ] :SEMAsk:DETEctor:CARRier:AUTO ON OFF 1 0</code> <code>[ :SENSe ] :SEMAsk:DETEctor:CARRier:AUTO?</code>
Example	<code>SEM:DET:CARR:AUTO OFF</code> <code>SEM:DET:CARR:AUTO?</code>
Notes	See Couplings in the Trace Type section. You must be in the mode that includes SEM measurement to use this command. Use <code>:INSTRument:SElect</code> to set the mode.
Preset	ON
State Saved	Saved in instrument state
Range	On Off
Initial S/W Revision	Prior to A.02.00
Modified at S/W Revision	A.02.00, A.03.00

### Chan Detector Selection

Selects the detector mode for the reference channel.

Key Path	Trace/Detector
Mode	SA, WCDMA, C2K, WIMAX OFDMA, TD-SCDMA, 1xEVDO, DTMB (CTTB), DVB-T/H, ISDB-T, CMMB, LTE, LTETDD, Digital Cable TV, WLAN, MSR, LTEAFDD, LTEATDD
Remote Command	<code>[ :SENSe ] :SEMAsk:DETEctor:CARRier[:FUNctIon] AVERAge   NEGAtive   NORMAl</code> <code>  POSitive   SAMPlE</code> <code>[ :SENSe ] :SEMAsk:DETEctor:CARRier[:FUNctIon]?</code>

<b>Example</b>	SEM:DET:CARR NEG SEM:DET:CARR?
<b>Notes</b>	When you manually select a detector (instead of selecting Auto), that detector is used regardless of other analyzer settings.  Note: This detector setting affects the reference channel. There is not a per trace detector. You must be in the mode that includes SEM measurement to use this command. Use :INSTrument:SElect to set the mode.
<b>Couplings</b>	See Couplings in the Trace Type section.
<b>Preset</b>	AVERage
<b>State Saved</b>	Saved in instrument state.
<b>Range</b>	Normal Average Peak Sample Negative Peak
<b>Initial S/W Revision</b>	Prior to A.02.00
<b>Modified at S/W Revision</b>	A.02.00, A.03.00

## Offset Detector

Accesses a menu of functions that enable you to control the detector for offsets. The following choices are available.

- Auto– the detector selected depends on marker functions, trace functions, average type, and the trace averaging function.
- Normal–the detector determines the peak of the CW-like signals, and it yields alternating maximums and minimums of noise-like signals. This is also referred to as Rosenfell detection.
- Average–the detector determines the average of the signal within the sweep points. The averaging method depends upon the Average Type selection (voltage, power or log scales).
- Peak–the detector determines the maximum of the signal within the sweep points.
- Sample–the detector indicates the instantaneous level of the signal at the center of the sweep points represented by each display point.
- Negative Peak–the detector determines the minimum of the signal within the sweep points.

<b>Key Path</b>	Trace/Detector
<b>Initial S/W Revision</b>	Prior to A.02.00

## Offset Detector Auto

Sets the detector to the default detection mode for the offsets. This mode is dependent upon the current signal conditions of the offsets.

<b>Key Path</b>	Trace/Detector
<b>Mode</b>	SA, WCDMA, C2K, WIMAX OFDMA, TD-SCDMA, 1xEVDO, DTMB (CTTB), DVB-T/H, ISDB-T, CMMB,

	LTE, LTE-TDD, Digital Cable TV, WLAN, MSR, LTE-AFDD, LTE-TDD
<b>Remote Command</b>	<code>[ :SENSe ] :SEMAsk :DETEctor :OFFSet :AUTO ON   OFF   1   0</code> <code>[ :SENSe ] :SEMAsk :DETEctor :OFFSet :AUTO ?</code>
<b>Example</b>	<code>SEM:DET:OFFS:AUTO OFF</code> <code>SEM:DET:OFFS:AUTO ?</code>
<b>Notes</b>	See Couplings in the Trace Type section. You must be in the mode that includes SEM measurement to use this command. Use <code>:INSTRument:SElect</code> to set the mode.
<b>Preset</b>	ON
<b>State Saved</b>	Saved in instrument state.
<b>Range</b>	On Off
<b>Initial S/W Revision</b>	Prior to A.02.00
<b>Modified at S/W Revision</b>	A.02.00, A.03.00

## Offset Detector Selection

Selects the detector mode for the offsets.

<b>Key Path</b>	Trace/Detector
<b>Mode</b>	SA, WCDMA, C2K, WIMAX OFDMA, TD-SCDMA, 1xEVDO, DTMB (CTTB), DVB-T/H, ISDB-T, CMMB, LTE, LTE-TDD, Digital Cable TV, WLAN, MSR, LTE-AFDD, LTE-TDD
<b>Remote Command</b>	<code>[ :SENSe ] :SEMAsk :DETEctor :OFFSet [ :FUNction ] AVERAge   NEGAtive   NORMAl</code> <code>  POSitive   SAMPlE</code> <code>[ :SENSe ] :SEMAsk :DETEctor :OFFSet [ :FUNction ] ?</code>
<b>Example</b>	<code>SEM:DET:OFFS AVER</code> <code>SEM:DET:OFFS ?</code>
<b>Notes</b>	When you manually select a detector (instead of selecting Auto), that detector is used regardless of other analyzer settings. Note: This detector setting has effects all offsets. There is not a per trace detector. You must be in the mode that includes SEM measurement to use this command. Use <code>:INSTRument:SElect</code> to set the mode.
<b>Couplings</b>	See Couplings in the Trace Type section.
<b>Preset</b>	POSitive
<b>State Saved</b>	Saved in instrument state.
<b>Range</b>	Normal Average Peak Sample Negative Peak
<b>Initial S/W Revision</b>	Prior to A.02.00
<b>Modified at S/W Revision</b>	A.02.00, A.03.00



## Trigger

See ["Trigger" on page 244](#)

### Free Run

See ["Free Run " on page 251](#)

### Video

See ["Video \(IF Envelope\) " on page 1160](#)

### Trigger Level

See ["Trigger Level " on page 1161](#)

### Trig Slope

See ["Trig Slope " on page 1162](#)

### Trig Delay

See ["Trig Delay " on page 254](#)

### External 1

See ["External 1 " on page 1175](#)

### Trigger Level

See ["Trigger Level " on page 1175](#)

### Trig Slope

See ["Trig Slope " on page 1176](#)

### Trig Delay

See ["Trig Delay " on page 257](#)

### Zero Span Delay Comp

See ["Zero Span Delay Comp On/Off " on page 1164](#)

### External 2

See ["External 2 " on page 1177](#)

### Trigger Level

See ["Trigger Level " on page 1177](#)

### Trig Slope

See ["Trig Slope " on page 1178](#)

### **Trig Delay**

See "[Trig Delay](#) " on page 260

### **Zero Span Delay Comp**

See "[Zero Span Delay Comp On/Off](#)" on page 1166

### **RF Burst**

See "[RF Burst](#) " on page 1178

### **Absolute Trigger**

See "[Absolute Trigger Level](#)" on page 1179

### **Relative Trigger**

See "[Relative Trigger Level](#)" on page 1168

### **Trig Slope**

See "[Trigger Slope](#) " on page 1180

### **Trig Delay**

See "[Trig Delay](#) " on page 264

### **Periodic Timer**

See "[Periodic Timer \(Frame Trigger\)](#) " on page 1170

### **Period**

See "[Period](#) " on page 1171

### **Offset**

See "[Offset](#) " on page 1172

### **Reset Offset Display**

See "[Reset Offset Display](#) " on page 1174

### **Sync Source**

See "[Sync Source](#) " on page 1174

### **Off**

See "[Off](#) " on page 1175

### **External 1**

See "[External 1](#) " on page 1175

**Trigger Level**

See ["Trigger Level "](#) on page 1175

**Trig Slope**

See ["Trig Slope "](#) on page 1176

**External 2**

See ["External 2 "](#) on page 1177

**Trigger Level**

See ["Trigger Level "](#) on page 1177

**Trig Slope**

See ["Trig Slope "](#) on page 1178

**RF Burst**

See ["RF Burst "](#) on page 1178

**Absolute Trigger**

See ["Absolute Trigger Level"](#) on page 1179

**Trig Slope**

See ["Trigger Slope "](#) on page 1180

**Trig Delay**

See ["Trig Delay"](#) on page 275

**Auto/Holdoff**

See ["Auto/Holdoff "](#) on page 1181

**Auto Trig**

See ["Auto Trig "](#) on page 1181

**Trig Holdoff**

See ["Trig Holdoff "](#) on page 1182

**Internal**

See ["Internal"](#) on page 277

## User Preset

Accesses a menu that gives you the following three choices:

- User Preset – recalls a state previously saved using the Save User Preset function.
- User Preset All Modes – presets all of the modes in the analyzer
- Save User Preset– saves the current state for the current mode

**NOTE**

In products that run multiple instances of the X-Series Application, all instances use the same location to save User Preset state. So Save User Preset of one instance will overwrite the Save User Preset of another instance.

Key Path	Front-panel key
Backwards Compatibility Notes	<p>User Preset is actually loading a state, and in legacy analyzers, it was possible to load a state without affecting the trace data, limit lines or correction data. Similarly it was possible to do a User Preset without affecting the trace data, limit lines or correction data.</p> <p>In the X-Series, “state” always includes all of this data; so whenever state is loaded, or User Preset is executed, all of the traces, limit lines and corrections are affected. Although this differs from previous behavior, it is desirable behavior, and should not cause adverse issues for users.</p> <p>On ESA and PSA, User Preset affected the entire instrument’s state. In the X-Series, User Preset only recalls the state for the active mode. There is a User Preset file for each mode. User Preset can never cause a mode switch as it can in legacy analyzers. If you want to recall all modes to their user preset file state, you will need to do a User Preset after mode switching into each mode.</p> <p>User Preset recalls mode state which can now include data like traces; whereas on ESA and PSA, User Preset did not affect data.</p>
Initial S/W Revision	Prior to A.02.00

## User Preset

User Preset sets the state of the currently active mode back to the state that was previously saved for this mode using the Save User Preset menu key or the SCPI command, SYST:PRES:USER:SAV. It not only recalls the Mode Preset settings, but it also recalls all of the mode persistent settings, and the Input/Output system setting that existed at the time Save User Preset was executed.

If a Save User Preset has not been done at any time, User Preset recalls the default user preset file for the currently active mode. The default user preset files are created if, at power-on, a mode detects there is no user preset file. There will never be a scenario when there is no user preset file to restore. For each mode, the default user preset state is the same state that would be saved if a Save User Preset is performed in each mode right after doing a Restore Mode Default and after a Restore Input/Output Defaults.

The User Preset function does the following:

- Aborts the currently running measurement.
- Sets the mode State to the values defined by Save User Preset.
- Makes the saved measurement for the currently running mode the active measurement.
- Brings up the saved menu for the power-on mode.

- Clears the input and output buffers.
- Sets the Status Byte to 0.

Key Path	User Preset
<b>Remote Command</b>	:SYSTem:PRESet:USER
<b>Example</b>	:SYST:PRES:USER:SAVE:SYST:PRES:USER
Notes	:SYST:PRES:USER:SAVE is used to save the current state as the user preset state. Clears all pending OPC bits. The Status Byte is set to 0. Pressing the User Preset front-panel key while already in the User Preset menu will cause the User Preset to get executed
Couplings	A user preset will cause the currently running measurement to be aborted and cause the saved measurement to be active. Recalling a User Preset file has the same issues that recalling a Save State file has. Some settings may need to be limited and therefore re-coupled, since the capabilities of the mode may have changes when the User Preset file was last saved.
Initial S/W Revision	Prior to A.02.00

## User Preset All Modes

Recalls all of the User Preset files for each mode, switches to the power-on mode, and activates the saved measurement from the power-on mode User Preset file.

**NOTE**

When the instrument is secured, all of the user preset files are converted back to their default user preset files.

The User Preset function does the following:

- Aborts the currently running measurement.
- Switches the Mode to the power-on mode.
- Restores the User Preset files for each mode.
- Makes the saved measurement for the power-on mode the active measurement.
- Brings up the saved menu for the power-on mode.
- Clears the input and output buffers.
- Sets the Status Byte to 0.

Key Path	User Preset
<b>Remote Command</b>	:SYSTem:PRESet:USER:ALL
<b>Example</b>	:SYST:PRES:USER:SAVE:SYST:PRES:USER:ALL
Notes	Clears all pending OPC bits. The Status Byte is set to 0. :SYST:PRES:USER:SAVE is used to save the current state as the user preset state.
Couplings	A user preset will cause the currently running measurement to be aborted, cause a mode switch to the power-on mode, and cause the saved measurement to be active in the power-on mode.

---

Recalling a User Preset file has the same issues that recalling a Save State file has. Some settings may need to be limited and therefore re-coupled, since the capabilities of the mode may have changes when the User Preset file was last saved.

---

Initial S/W Revision      Prior to A.02.00

---

## Save User Preset

Saves the currently active mode and its State. You can recall this User Preset file by pressing the User Preset menu key or sending the SYST:PRES:USER remote command. This same state is also saved by the Save State function.

---

Key Path                      User Preset

---

**Remote Command**        :SYSTem:PRESet:USER:SAVE

---

**Example**                    :SYST:PRES:USER:SAVE

---

Notes                        :SYST:PRES:SAVE creates the same file as if the user requested a \*SAV or a MMEM:STOR:STAT, except User Preset Save does not allow the user to specify the filename or the location of the file.

---

Initial S/W Revision      Prior to A.02.00

---

## View/Display

Accesses a menu of functions that enable you to control the instrument display.

The following keys select how the results are displayed:

- **Abs Pwr Freq**—displays the absolute power levels in dBm and the corresponding frequencies in the text window.
- **Rel Pwr Freq**—displays the relative power levels in dBc and the corresponding frequencies in the text window.
- **Integrated Power**—displays the absolute and relative power levels integrated throughout the bandwidths between the start and stop frequencies in the text window.
- **Carrier Info** —displays the carrier configuration information with measure powers. (Only available in MSR and LTE-Advanced FDD/TDD)

["View Selection by Name \(Remote Command Only\)" on page 1195](#)

["Views Selection by Number \(Remote Command only\)" on page 1196](#)

### View Selection by Name (Remote Command Only)

Key Path	View/Display
Mode	SA, WCDMA, C2K, WIMAX OFDMA, TD-SCDMA, 1xEVDO, DTMB (CTTB), DVB-T/H, ISDB-T, CMMB, LTE, LTE-TDD, Digital Cable TV, WLAN, MSR, LTEAFDD, LTEATDD
Remote Command	:DISPlay:SEMask:VIEW[:SElect] APFReq   RPFReq   IPOWer   CINformation :DISPlay:SEMask:VIEW[:SElect]?
Example	DISP:SEM:VIEW IPOW DISP:SEM:VIEW?
Notes	You must be in the mode that includes SEM measurement to use this command. Use :INSTrument:SElect to set the mode.
Dependencies	In the SA mode, when "Radio Standard" is set to WLAN, IPOWer is not available and the key is grayed out. CINformation is available only in MSR and LTE-Advanced FDD/TDD mode, otherwise the key is blank.
Preset	SA, , WCDMA, , C2K, , TD-SCDMA, , 1xEVDO, , DTMB (CTTB), , DVB-T/H, , ISDB-T, , CMMB, , LTE, , LTE-TDD, , Digital Cable TV, , MSR, , LTEAFDD, , LTEATDD: APFReq WIMAX OFDMA, WLAN: RPFReq
State Saved	Saved in instrument state.
Range	Abs Pwr & Freq  Rel Pwr & Freq Integrated Power Carrier Info
Initial S/W Revision	Prior to A.02.00
Modified at S/W Revision	A.02.00, A.03.00, A.10.00

### Views Selection by Number (Remote Command only)

The following numerical selections determine how the results are displayed:

1. displays the absolute power levels in dBm and the corresponding frequencies in the text window.
2. displays the relative power levels in dBc and the corresponding frequencies in the text window.
3. displays the absolute and relative power levels integrated throughout the bandwidths between the start and stop frequencies in the text window.
4. displays the carrier info table. (Only available in MSR and LTE-Advanced FDD/TDD)

<b>Mode</b>	SA, WCDMA, C2K, WIMAX OFDMA, TD-SCDMA, 1xEVDO, DTMB (CTTB), DVB-T/H, ISDB-T, CMMB, LTE, LTETDD, Digital Cable TV, WLAN, MSR, LTEAFDD, LTEATDD
<b>Remote Command</b>	:DISPlay:SEMask:VIEW:NSElect <integer> :DISPlay:SEMask:VIEW:NSElect?
<b>Example</b>	DISP:SEM:VIEW:NSEL 2 DISP:SEM:VIEW:NSEL?
<b>Notes</b>	In the SA mode, when "Radio Standard" is set to WLAN, Option 3 is not available. Option 4 is available only in MSR and LTE-Advanced FDD/TDD mode. You must be in the mode that includes SEM measurement to use this command. Use :INSTrument:SElect to set the mode.
<b>Preset</b>	SA, , WCDMA, , C2K, , TD-SCDMA, , 1xEVDO, , DTMB (CTTB), , DVB-T/H, , ISDB-T, , CMMB, , LTE, , LTETDD, , Digital Cable TV, , MSR, , LTEAFDD, , LTEATDD: 1 WIMAX OFDMA, WLAN: 2
<b>State Saved</b>	Saved in instrument state.
<b>Min</b>	1
<b>Max</b>	MSR, LTEAFDD, LTEATDD: 4 Other modes: 3
<b>Initial S/W Revision</b>	Prior to A.02.00
<b>Modified at S/W Revision</b>	A.02.00, A.03.00, A.10.00

<b>Key Path</b>	Front-panel key
<b>Initial S/W Revision</b>	Prior to A.02.00

### Display

The Display menu is common to most measurements, and is used for configuring items on the display. Some Display menu settings apply to all the measurements in a mode, and some only to the current measurement. Those under the System Display Settings key apply to all measurements in all modes.

<b>Key Path</b>	Display
-----------------	---------



---

Key Path	View/Display
Initial S/W Revision	Prior to A.02.00

---

## Annotation

Turns on and off various parts of the display annotation. The annotation is divided up into four categories:

1. Meas Bar: This is the measurement bar at the top of the screen. It does not include the settings panel or the Active Function. Turning off the Meas Bar turns off the settings panel and the Active Function. When the Meas Bar is off, the graticule area expands to fill the area formerly occupied by the Meas Bar.
2. Screen Annotation: this is the annotation and annunciation around the graticule, including any annotation on lines (such as the display line, the threshold line, etc.) This does NOT include the marker number or the N dB result. When off, the graticule expands to fill the entire graticule area.
3. Trace annotation: these are the labels on the traces, showing their detector (or their math mode).
4. Active Function annotation: this is the active function display in the meas bar, and all of the active function values displayed on softkeys.

See the figure below. Each type of annotation can be turned on and off individually.

10 Spectrum Emission Mask Measurement  
View/Display

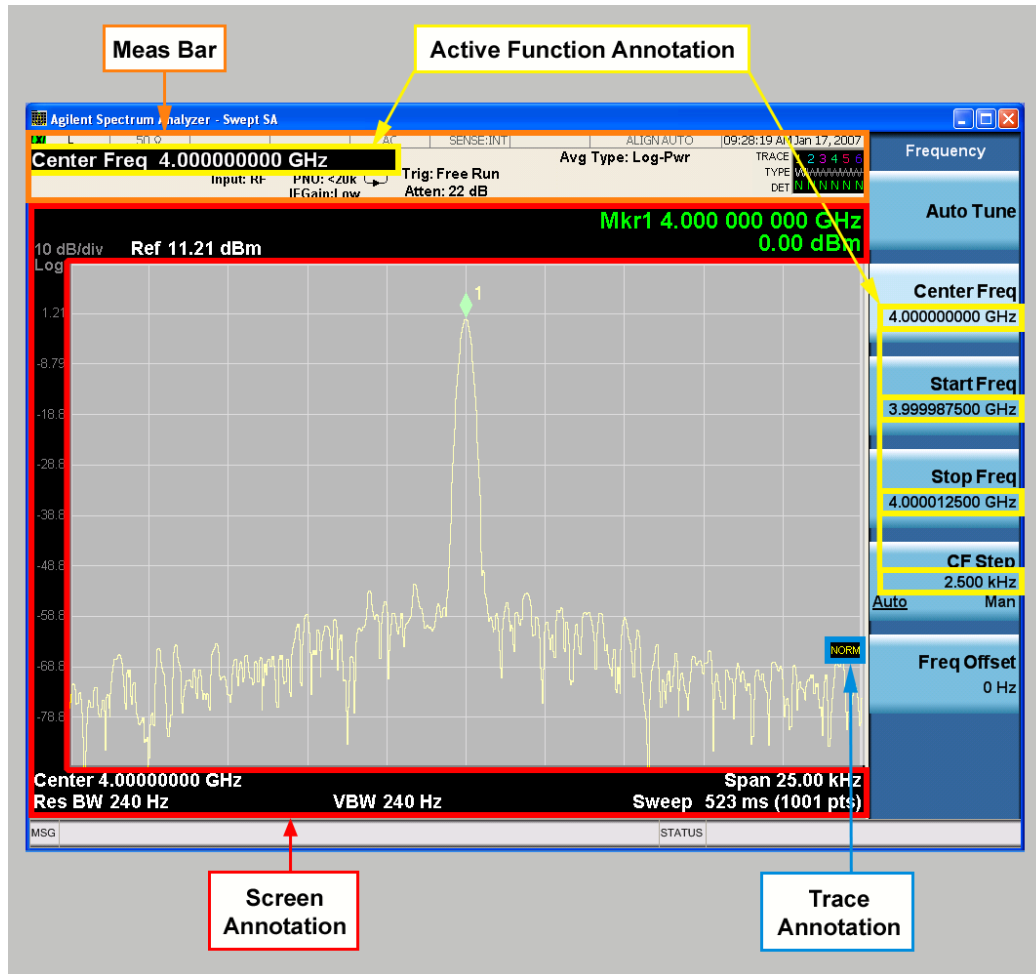

Key Path	View/Display, Display
Initial S/W Revision	Prior to A.02.00

Meas Bar On/Off

This function turns the Measurement Bar on and off, including the settings panel. When off, the graticule area expands to fill the area formerly occupied by the Measurement Bar.

Key Path	View/Display, Display, Annotation
Remote Command	:DISPlay:ANNOtation:MBAR[:STATe] OFF ON 0 1 :DISPlay:ANNOtation:MBAR[:STATe]?
Example	DISP:ANN:MBAR OFF
Dependencies	Grayed out and forced to OFF when System Display Settings, Annotation is set to Off.
Preset	On This should remain Off through a Preset when System DisplaySettings, Annotation is set to Off.

State Saved	Saved in instrument state.
Initial S/W Revision	Prior to A.02.00

## Screen

This controls the display of the annunciation and annotation around the graticule, including any annotation on lines (such as the display line, the threshold line, etc.) and the y-axis annotation. This does NOT include marker annotation (or the N dB result). When off, the graticule expands to fill the entire graticule area, leaving only the 1.5% gap above the graticule as described in the Trace/Detector chapter.

Key Path	View/Display, Display, Annotation
<b>Remote Command</b>	:DISPlay:ANNotation:SCReen[:STATe] OFF ON 0 1 :DISPlay:ANNotation:SCReen[:STATe]?
<b>Example</b>	DISP:ANN:SCR OFF
Dependencies	Grayed-out and forced to OFF when System Display Settings, Annotation is set to Off.
Preset	On This should remain Off through a Preset when System DisplaySettings, Annotation is set to Off
State Saved	Saved in instrument state.
Initial S/W Revision	Prior to A.02.00

## Active Function Values On/Off

Turns on and off the active function display in the Meas Bar, and all of the active function values displayed on the softkeys.

Note that all of the softkeys that have active functions have these numeric values blanked when this function is on. This is a security feature..

10 Spectrum Emission Mask Measurement  
View/Display

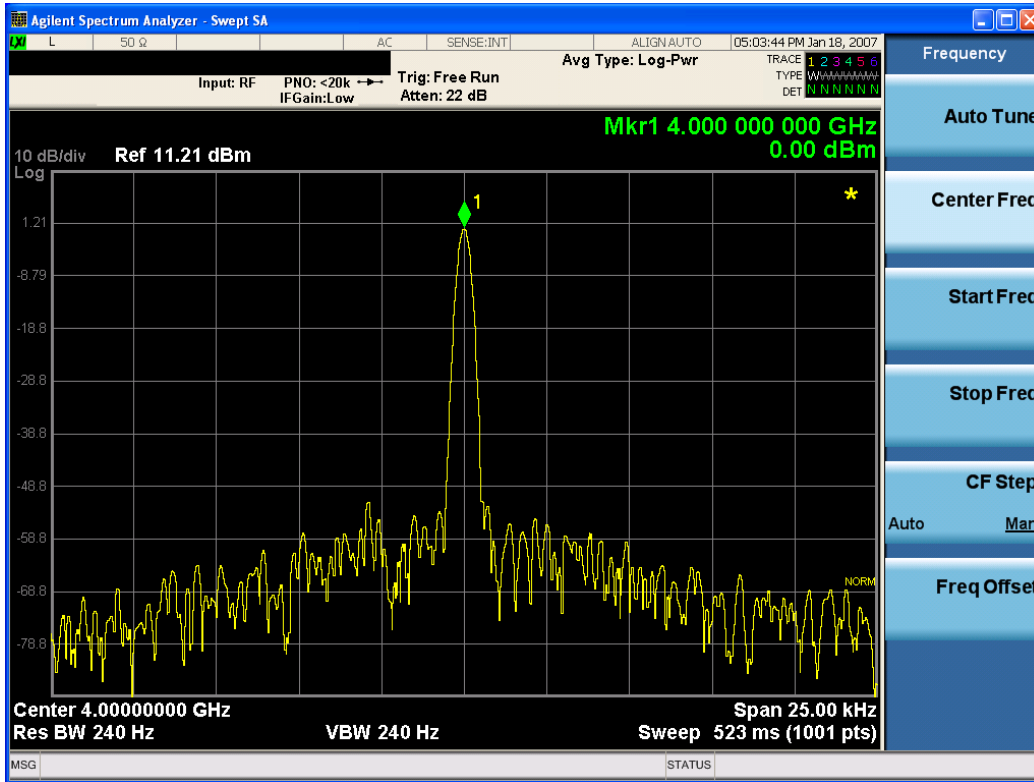

Key Path	View/Display, Display, Annotation
Remote Command	:DISPlay:ACTivefunc[:STATE] ON OFF 1 0 :DISPlay:ACTivefunc[:STATE]?
Example	DISP:ACT OFF
Dependencies	Grayed out and forced to OFF when System Display Settings, Annotation is set to Off.
Preset	On This should remain Off through a Preset when System DisplaySettings, Annotation is set to Off
State Saved	Saved in instrument state.
Initial S/W Revision	Prior to A.02.00

Title

Displays menu keys that enable you to change or clear a title on your display.

Key Path	View/Display, Display
Initial S/W Revision	Prior to A.02.00

Change Title

Writes a title into the "measurement name" field in the banner, for example, "Swept SA".

Press Change Title to enter a new title through the alpha editor. Press Enter or Return to complete the entry. Press ESC to cancel the entry and preserve your existing title.

The display title will replace the measurement name. It remains for this measurement until you press Change Title again, or you recall a state, or a Preset is performed. A title can also be cleared by pressing Title, Clear Title.

**NOTE**

Notice the inclusion of the <measurement> parameter in the command below. Because each measurement remembers the Display Title, the command must be qualified with the measurement name. For the Swept SA measurement this is not the case; no <measurement> parameter is used when changing the Display Title for the Swept SA measurement.

Key Path	View/Display, Display, Title
Mode	All
Remote Command	:DISPlay:<measurement>:ANNotation:TITLe:DATA <string> :DISPlay:<measurement>:ANNotation:TITLe:DATA?
Example	DISP:ANN:TITL:DATA "This Is My Title" This example is for the Swept SA measurement in the Spectrum Analyzer mode. The SANalyzer <measurement> name is not used. DISP:ACP:ANN:TITL:DATA "This Is My Title" This example is for Measurements other than Swept SA. Both set the title to: This Is My Title
Notes	Pressing this key cancels any active function. When a title is edited the previous title remains intact (it is not cleared) and the cursor goes at the end so that characters can be added or BKSP can be used to go back over previous characters.
Preset	No title (measurement name instead)
State Saved	Saved in instrument state.
Initial S/W Revision	Prior to A.02.00

### Clear Title

Clears a title from the front-panel display. Once cleared, the title cannot be retrieved. After the title is cleared, the current Measurement Name replaces it in the title bar.

Key Path	View/Display, Display, Title
Example	The following commands clear the title and restore the measurement's original title: DISP:ANN:TITL:DATA "" This example is for the Swept SA measurement in the Spectrum Analyzer mode. The SANalyzer <measurement> name is not used. DISP:ACP:ANN:TITL:DATA "" This example is for ACP; in measurements other than Swept SA the measurement name is required.
Notes	Uses the :DISPlay:<measurement>:ANNotation:TITLe:DATA <string> command with an empty string (in the Swept SA, the <measurement> is omitted).

Preset	Performed on Preset.
Initial S/W Revision	Prior to A.02.00

## Graticule

Pressing Graticule turns the display graticule On or Off. It also turns the graticule y-axis annotation on and off.

Key Path	View/Display, Display
Remote Command	:DISPlay:WINDow[1]:TRACe:GRATicule:GRID[:STATe] OFF ON 0 1 :DISPlay:WINDow[1]:TRACe:GRATicule:GRID[:STATe]?
Example	DISP:WIND:TRAC:GRAT:GRID OFF
Notes	The graticule is the set of horizontal and vertical lines that make up the grid/divisions for the x-axis and y-axis.
Preset	On
State Saved	Saved in instrument state
Initial S/W Revision	Prior to A.02.00

## System Display Settings

These settings are "Mode Global" – they affect all modes and measurements and are reset only by Restore Misc Defaults or Restore System Defaults under System.

Key Path	View/Display, Display
Initial S/W Revision	Prior to A.02.00

## Annotation Local Settings

This is a Mode Global override of the meas local annotation settings. When it is All Off, it forces ScreenAnnotation, Meas Bar, Trace, and Active Function Values settings to be OFF for all measurements in all modes. This provides the security based "annotation off" function of previous analyzers; hence it uses the legacy SCPI command.

When it is All Off, the Screen, Meas Bar, Trace, and Active Function Values keys under the Display, Annotation menu are grayed out and forced to Off. When Local Settings is selected, you are able to set the local annotation settings on a measurement by measurement basis.

Key Path	View/Display, Display, System Display Settings
Remote Command	:DISPlay:WINDow[1]:ANNotation[:ALL] OFF ON 0 1 :DISPlay:WINDow[1]:ANNotation[:ALL]?
Example	:DISP:WIND:ANN OFF

Preset	On (Set by Restore Misc Defaults)
State Saved	Not saved in instrument state.
Backwards Compatibility Notes	The WINDow parameter and optional subopcode is included for backwards compatibility but ignored – all windows are equally affected.
Initial S/W Revision	Prior to A.02.00

## Themes

Accesses a menu of functions that enable you to choose the theme to be used when saving the screen image.

The **Themes** option is the same as the **Themes** option under the **Display** and **Page Setup** dialogs. It allows you to choose between themes to be used when saving the screen image.

Key Path	Save, Screen Image
Remote Command	:MMEMory:STORe:SCReen:THEMe TDColor   TDMonochrome   FCOLOR   FMONochrome  :MMEMory:STORe:SCReen:THEMe?
Example	:MMEM:STOR:SCR:THEM TDM
Preset	3D Color; Is not part of Preset, but is reset by Restore Misc Defaults or Restore System Defaults All and survives subsequent running of the modes.
Readback	3D Color   3D Mono   Flat Color   Flat Mono
Backwards Compatibility Notes	In ESA and PSA we offer the choice of "Reverse Bitmap" or "Reverse Metafile" when saving screen images. This is much like the "Flat Color" theme available in X-Series. Also, if you selected Reverse Bitmap AND a black & white screen image, that would be much like "Flat Monochrome". In other words, each of the X-Series themes has a similar screen image type in ESA/PSA. But they are not identical.
Initial S/W Revision	Prior to A.02.00

### 3D Color

Selects a standard color theme with each object filled, shaded and colored as designed.

Key Path	Save, Screen Image, Themes
Example	MMEM:STOR:SCR:THEM TDC
Readback	3D Color
Initial S/W Revision	Prior to A.02.00

### 3D Monochrome

Selects a format that is like 3D color but shades of gray are used instead of colors.

Key Path	Save, Screen Image, Themes
<b>Example</b>	MMEM:STOR:SCR:THEM TDM
Readback	3D Mono
Initial S/W Revision	Prior to A.02.00

### Flat Color

Selects a format that is best when the screen is to be printed on an ink printer.

Key Path	Save, Screen Image, Themes
<b>Example</b>	MMEM:STOR:SCR:THEM FCOL
Readback	Flat Color
Initial S/W Revision	Prior to A.02.00

### Flat Monochrome

Selects a format that is like Flat Color. But only black is used (no colors, not even gray), and no fill.

Key Path	Save, Screen Image, Themes
<b>Example</b>	MMEM:STOR:SCR:THEM FMON
Readback	Flat Mono
Initial S/W Revision	Prior to A.02.00

### Abs Pwr Freq

Sets the display to the Absolute Peak Power and Frequency view. The views differ depending on the setting of the measurement type (Meas Type) under the Measurement Setup menu.

"Abs Peak Pwr & Freq (Total Pwr Ref)" on page 1204

"Abs Peak Pwr & Freq (PSD Ref)" on page 1206

"Abs Peak Pwr & Freq (Spectrum Pk Ref)" on page 1208

### Abs Peak Pwr & Freq (Total Pwr Ref)

This view consists of the following two windows:

"Trace Window" on page 1206

"Results Window " on page 1206



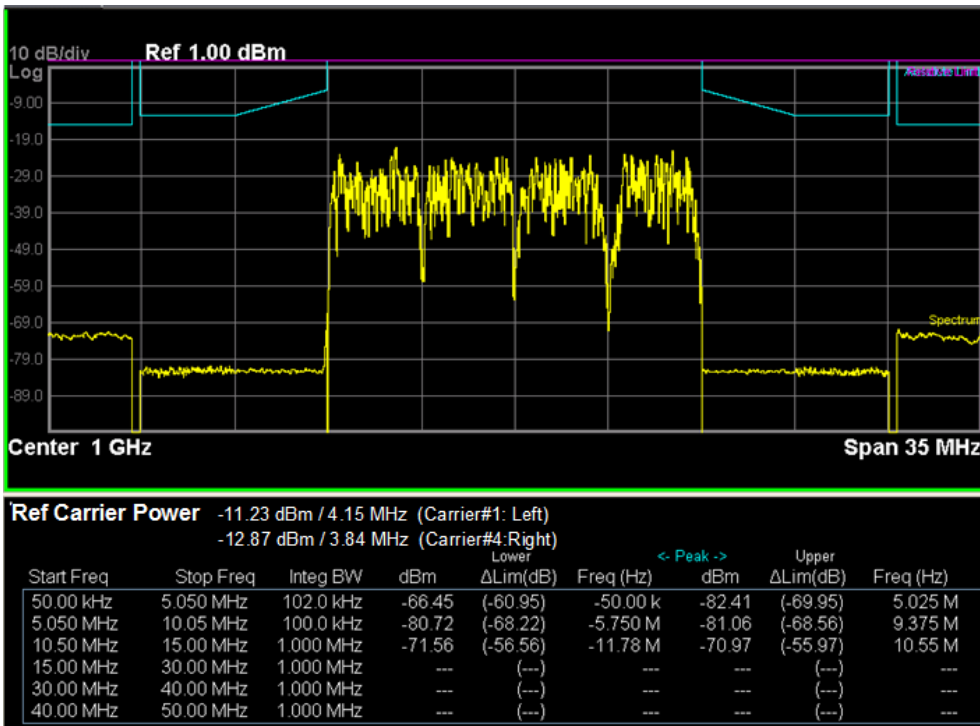
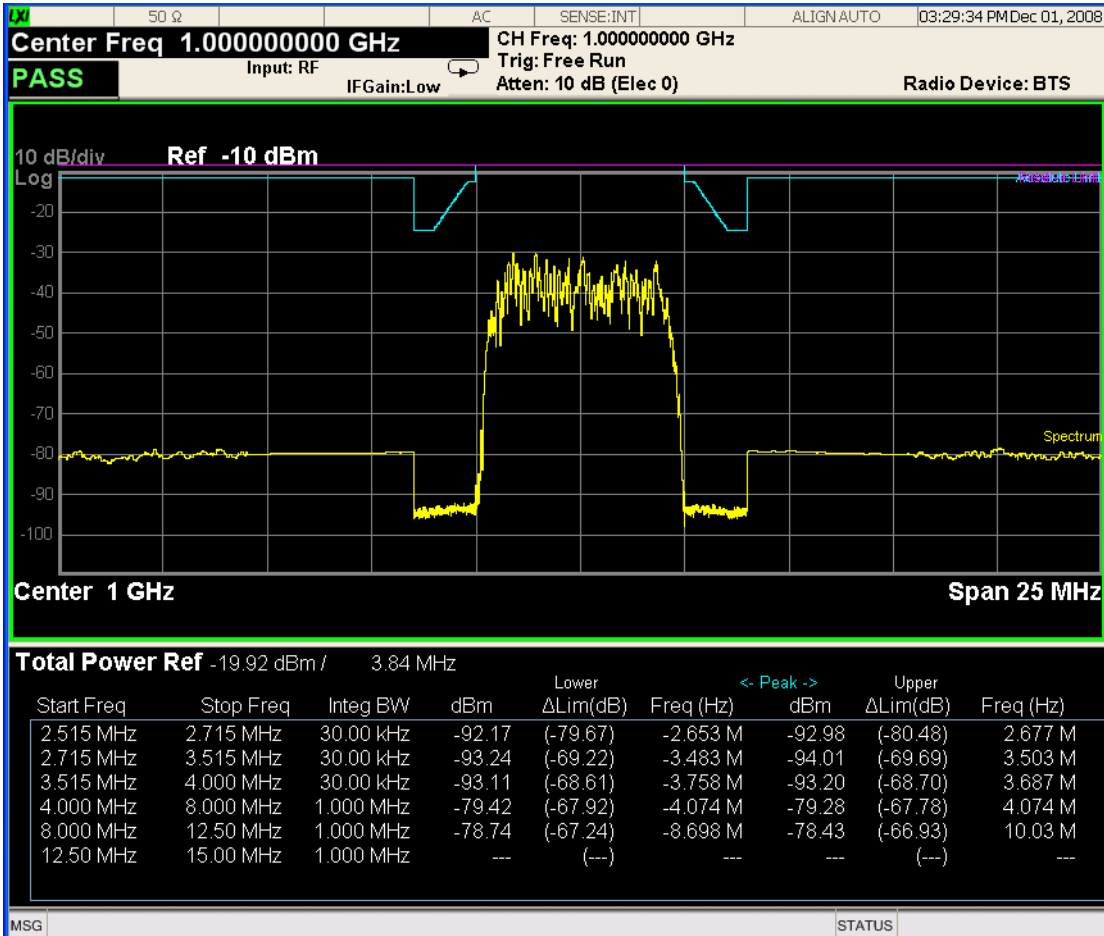

## Trace Window

Corresponding Trace	yellow - Combined trace from carrier and each offset
---------------------	------------------------------------------------------

## Results Window

Name	Corresponding Results
Total Pwr Ref	n=1 2nd element Absolute power at the reference area. Channel Integration Bandwidth
Start (Hz)	Start frequency for offset
Stop (Hz)	Stop frequency for offset
Meas BW (Hz)	Measurement bandwidth for offset
Lower Peak (dBm)	Absolute peak power on minimum margin point of the negative offset
Lower $\Delta$ lim (dB)	Minimum margin from limit line which is decided by Fail Mask setting on the negative offset
Lower Freq (Hz)	Frequency on minimum margin point of the negative offset
Upper Peak (dBm)	Absolute peak power on minimum margin point of the positive offset
Upper $\Delta$ lim (dB)	Minimum margin from limit line which is decided by Fail Mask setting on the positive offset
Upper Freq (Hz)	Frequency on minimum margin point of the positive offset

## Abs Peak Pwr & Freq (PSD Ref)

This view consists of the following two windows:

["Trace Window" on page 1208](#)

["Results Window " on page 1208](#)

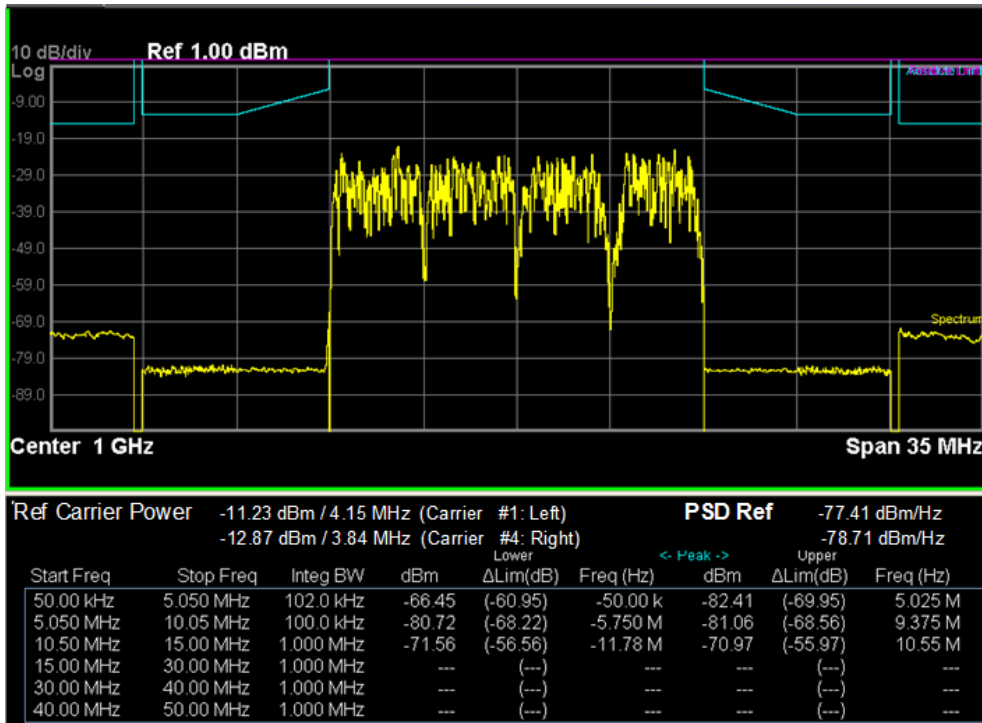
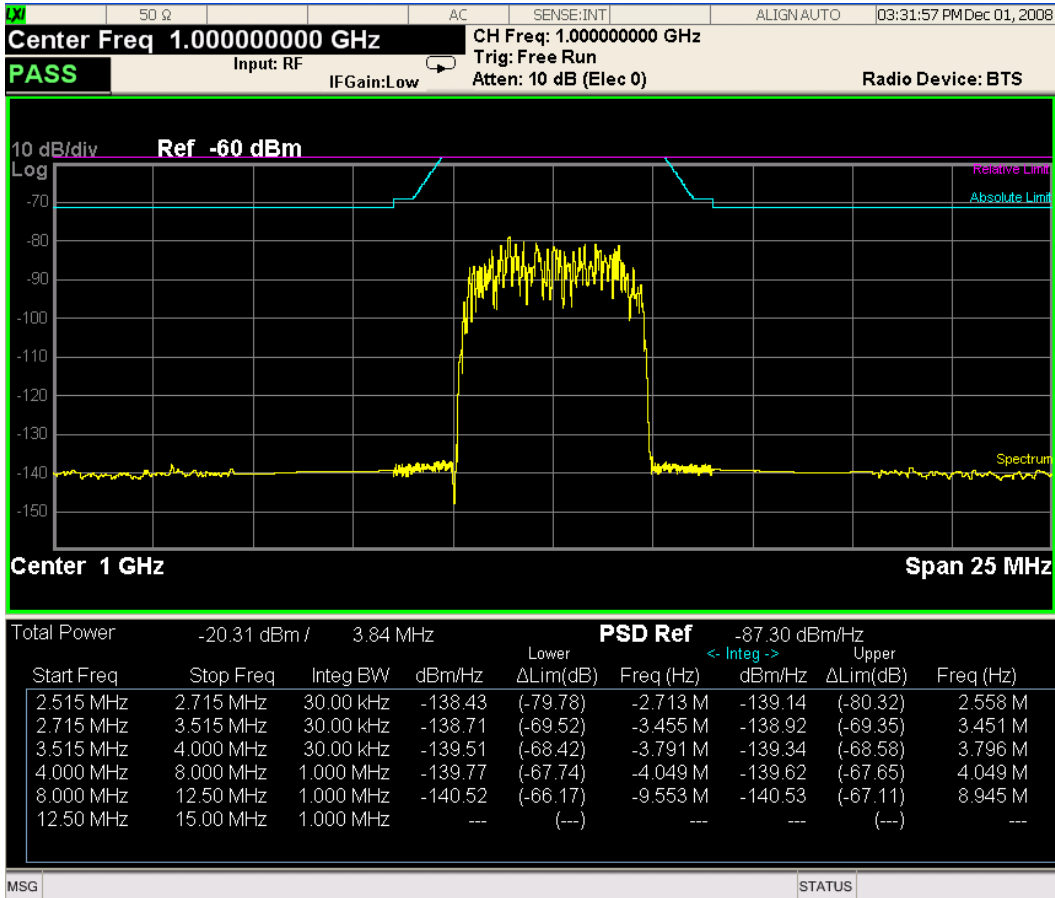

## Trace Window

Corresponding Trace	yellow - Combined trace from carrier and each offset
---------------------	------------------------------------------------------

## Results Window

Name	Corresponding Results
Total Pwr	n=1 2nd element Absolute power at the reference area.
	Channel Integration Bandwidth
PSD Ref	n=5 1st element Power spectral density reference at the reference area
Start (Hz)	Start frequency for offset
Stop (Hz)	Stop frequency for offset
Meas BW (Hz)	Measurement bandwidth for offset
Lower (dBm/Hz)	Absolute power spectrum density of the negative offset
Lower $\Delta$ lim (dB)	Minimum margin from limit line which is decided by Fail Mask setting on the negative offset
Lower Freq (Hz)	Frequency on minimum margin point of the negative offset
Upper (dBm/Hz)	Absolute power spectrum density of the positive offset
Upper $\Delta$ lim (dB)	Minimum margin from limit line which is decided by Fail Mask setting on the positive offset
Upper Freq (Hz)	Frequency on minimum margin point of the positive offset

## Abs Peak Pwr & Freq (Spectrum Pk Ref)

This view consists of the following two windows:

["Trace Window" on page 1208](#)

["Results Window " on page 1208](#)

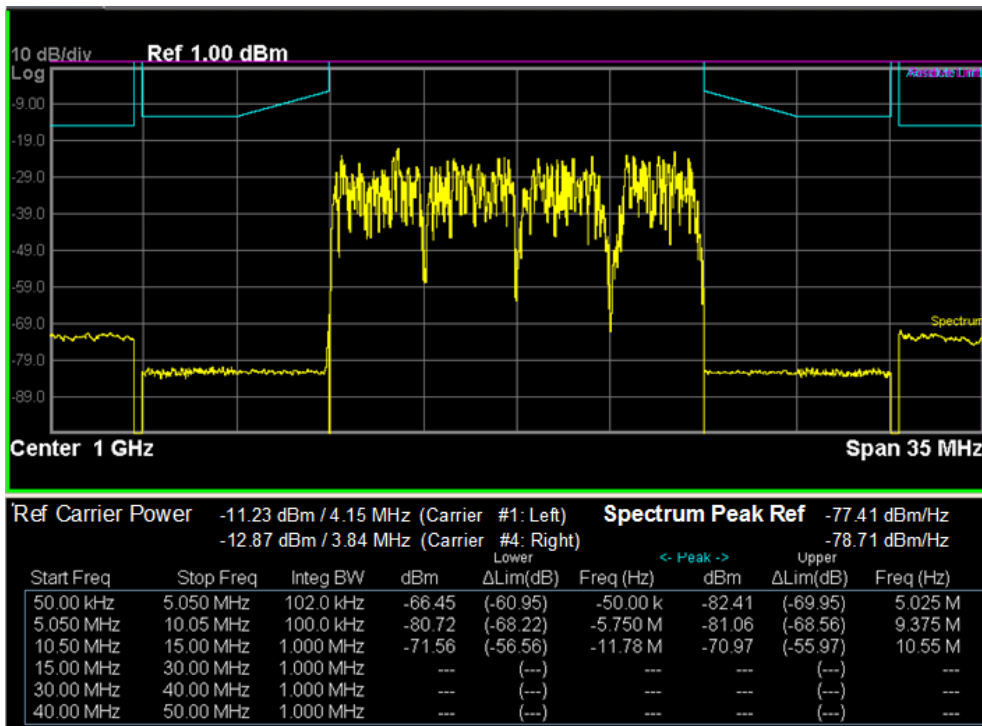
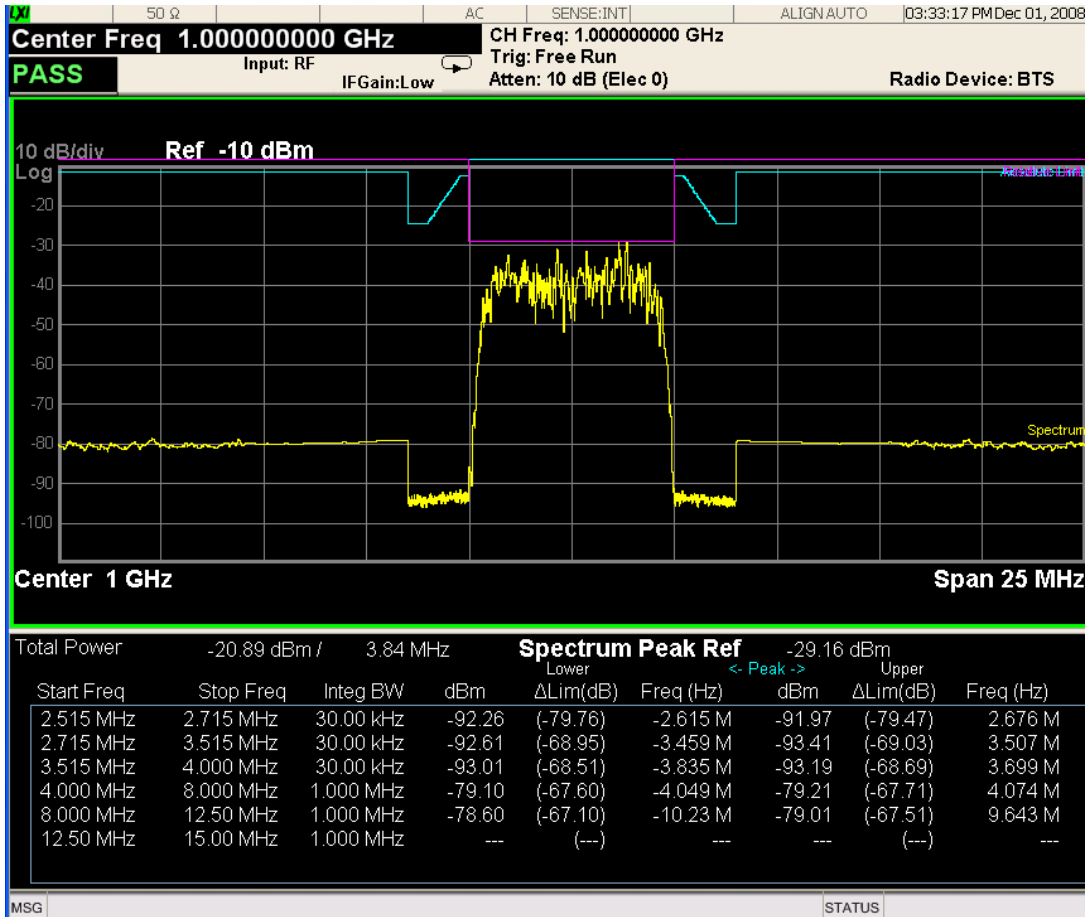

## Trace Window

Corresponding Trace	yellow - Combined trace from carrier and each offset
---------------------	------------------------------------------------------

## Results Window

Name	Corresponding Results
Total Pwr	Absolute power at the reference area. Channel Integration Bandwidth
Spectrum Peak Ref	n=5 1st element Spectrum peak power reference at the reference area
Start (Hz)	Start frequency for offset
Stop (Hz)	Stop frequency for offset
Meas BW (Hz)	Measurement bandwidth for offset
Lower(dBm)	Absolute peak power on minimum margin point of the negative offset
Lower $\Delta$ lim (dB)	Minimum margin from limit line which is decided by Fail Mask setting on the negative offset
Lower Freq (Hz)	Frequency on minimum margin point of the negative offset
Upper (dBm)	Absolute peak power on minimum margin point of the positive offset
Upper $\Delta$ lim (dB)	Minimum margin from limit line which is decided by Fail Mask setting on the positive offset
Upper Freq (Hz)	Frequency on minimum margin point of the positive offset

Key Path	View/Display
Initial S/W Revision	Prior to A.02.00

## Rel Pwr Freq

Sets the display to the Relative Peak Power and Frequency view. The views differ depending on the setting of the measurement type (Meas Type) under the Measurement Setup menu.

"Rel Peak Pwr & Freq (Total Pwr Ref)" on page 1210

"Rel Peak Pwr & Freq (PSD Ref)" on page 1212

"Rel Peak Pwr & Freq (Spectrum Pk Ref)" on page 1213

## Rel Peak Pwr & Freq (Total Pwr Ref)

This view consists of the following two windows:

"Trace Window" on page 1211

"Results Window" on page 1211

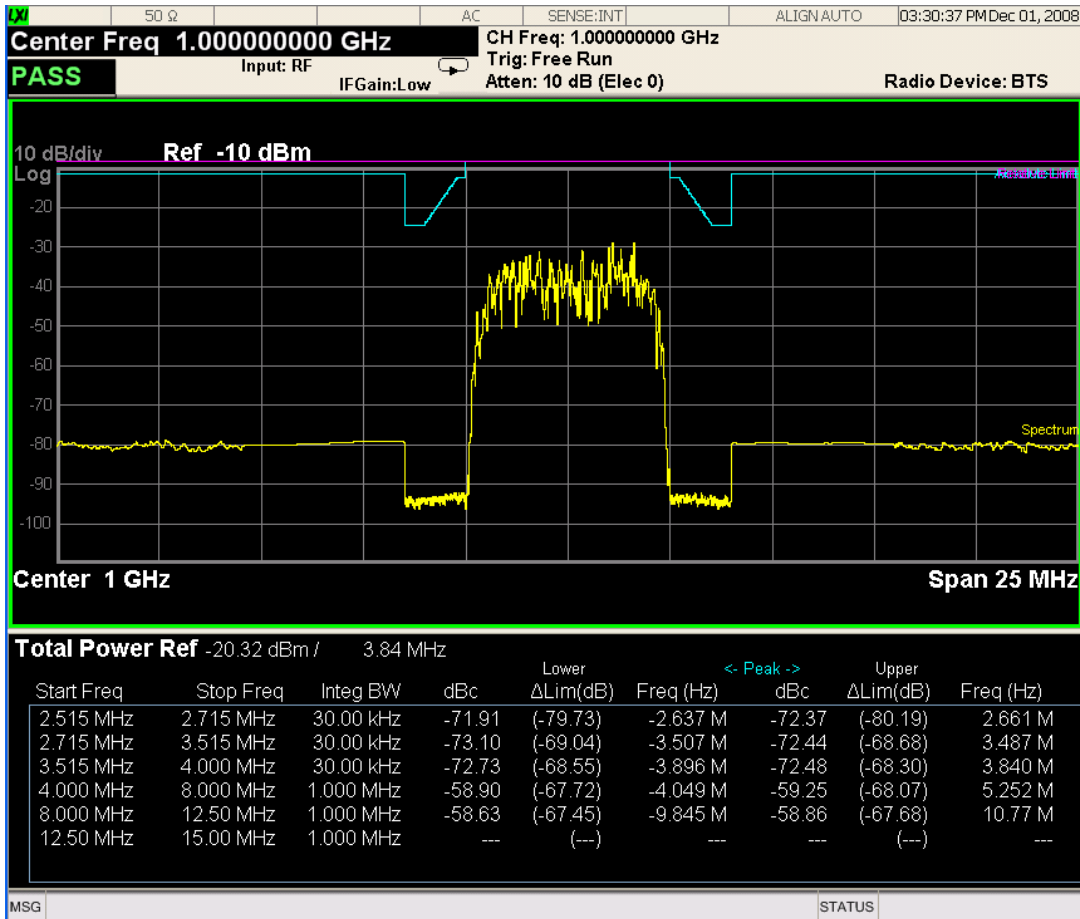

### Trace Window

Corresponding Trace      yellow - Combined trace from carrier and each offset

### Results Window

Name	Corresponding Results
Total Pwr Ref	n=1 2nd element Absolute power at the reference area.
	Channel Integration Bandwidth
Start (Hz)	Start frequency for offset
Stop (Hz)	Stop frequency for offset
Meas BW (Hz)	Measurement bandwidth for offset
Lower Peak (dBc)	Relative peak power on minimum margin point of the negative offset
Lower ΔLim (dB)	Minimum margin from limit line which is decided by Fail Mask setting on the negative offset

Name	Corresponding Results
Lower Freq (Hz)	Frequency on minimum margin point of the negative offset
Upper Peak (dBc)	Relative peak power on minimum margin point of the positive offset
Upper ΔLim (dB)	Minimum margin from limit line which is decided by Fail Mask setting on the positive offset
Upper Freq (Hz)	Frequency on minimum margin point of the positive offset

### Rel Peak Pwr & Freq (PSD Ref)

This view consists of the following two windows:

"Trace Window" on page 1212

"Results Window" on page 1213

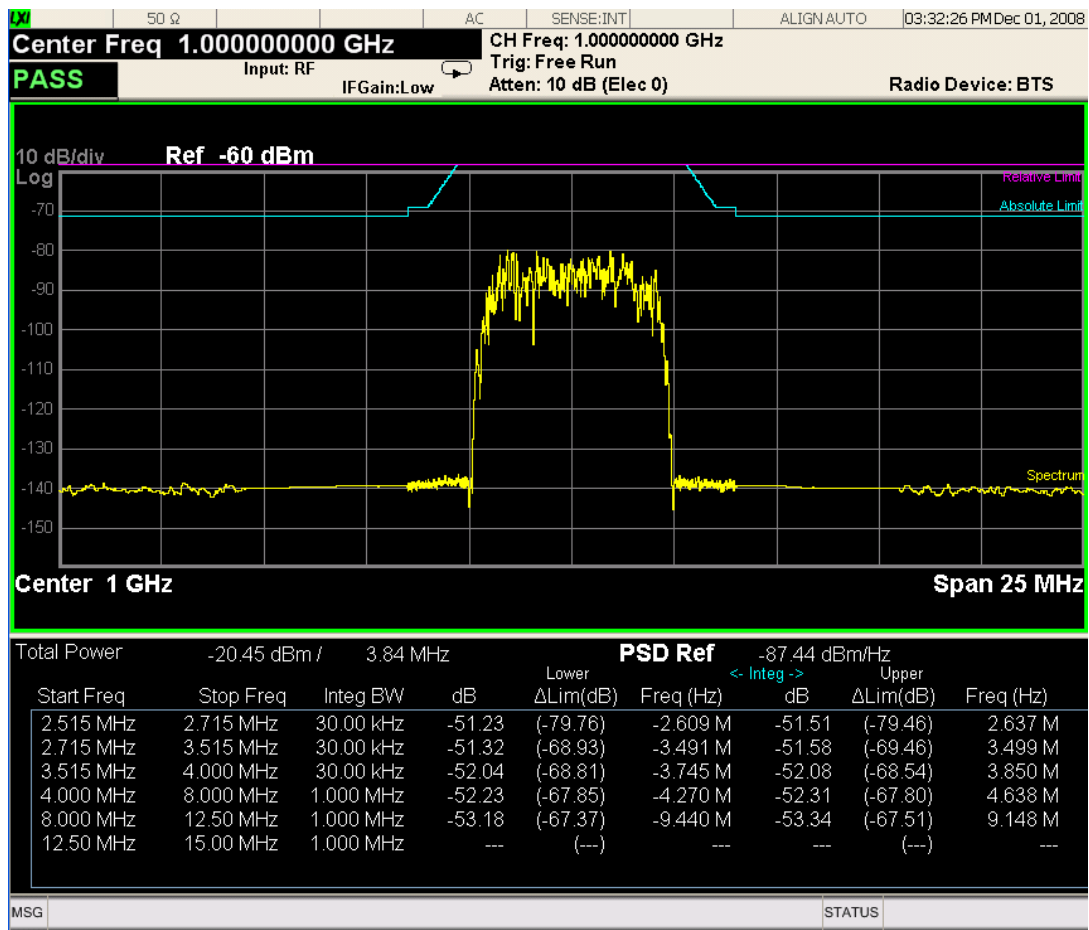

### Trace Window

Corresponding Trace yellow - Combined trace from carrier and each offset



## Results Window

Name	Corresponding Results
Total Pwr	n=1 2nd element Absolute power at the reference area.
	Channel Integration Bandwidth
PSD Ref	n=5 1st element Power spectral density reference at the reference area
Start (Hz)	Start frequency for offset
Stop (Hz)	Stop frequency for offset
Meas BW (Hz)	Measurement bandwidth for offset
Lower (dB)	Relative power spectrum density of the negative offset
Lower ΔLim (dB)	Minimum margin from limit line which is decided by Fail Mask setting on the negative offset
Lower Freq (Hz)	Frequency on minimum margin point of the negative offset
Upper (dB)	Relative power spectrum density of the positive offset
Upper ΔLim (dB)	Minimum margin from limit line which is decided by Fail Mask setting on the positive offset
Upper Freq (Hz)	Frequency on minimum margin point of the positive offset

## Rel Peak Pwr & Freq (Spectrum Pk Ref)

This view consists of the following two windows:

"Trace Window" on page 1211

"Results Window" on page 1211

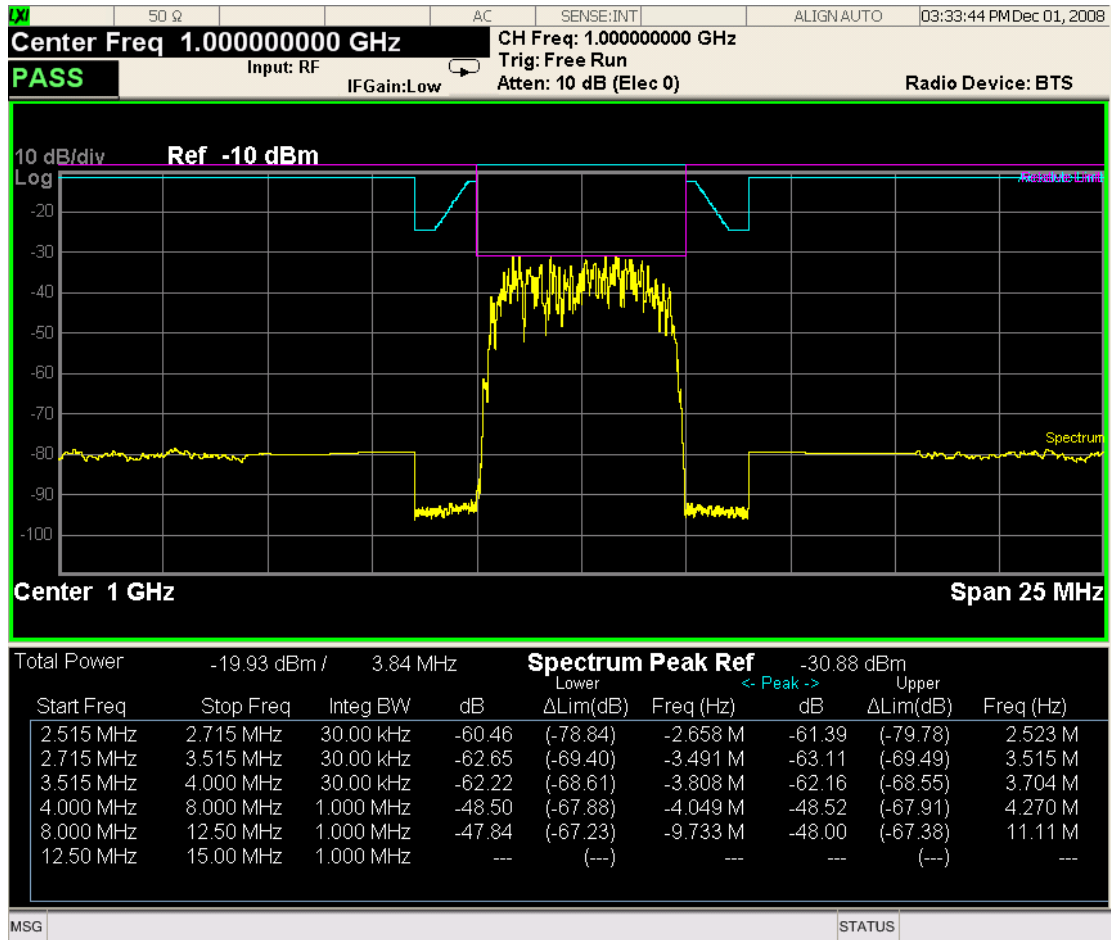

### Trace Window

Corresponding Trace	yellow - Combined trace from carrier and each offset
---------------------	------------------------------------------------------

### Results Window

Name	Corresponding Results
Total Pwr	Absolute power at the reference area.
	Channel Integration Bandwidth
Spectrum Peak Ref	n=5 1st element Spectrum peak power reference at the reference area
Start (Hz)	Start frequency for offset
Stop (Hz)	Stop frequency for offset
Meas BW (Hz)	Measurement bandwidth for offset
Lower Peak (dB)	Relative peak power on minimum margin point of the negative offset
Lower ΔLim (dB)	Minimum margin from limit line which is decided by Fail Mask setting

Name	Corresponding Results
	on the negative offset
Lower Freq (Hz)	Frequency on minimum margin point of the negative offset
Upper Peak (dB)	Relative peak power on minimum margin point of the positive offset
Upper ΔLim (dB)	Minimum margin from limit line which is decided by Fail Mask setting on the positive offset
Upper Freq (Hz)	Frequency on minimum margin point of the positive offset

Key Path	View/Display
Initial S/W Revision	Prior to A.02.00

## Integrated Power

Sets the display to the Integrated Power view. The views differ depending on the setting of the measurement type (Meas Type) under the Measurement Setup menu.

"Integrated Power (Total Pwr Ref)" on page 1215

"Integrated Power (PSD Ref)" on page 1218

"Integrated Power (Spectrum Pk Ref)" on page 1221

## Integrated Power (Total Pwr Ref)

"Trace Window" on page 1217

"Results Window" on page 1217

10 Spectrum Emission Mask Measurement  
View/Display

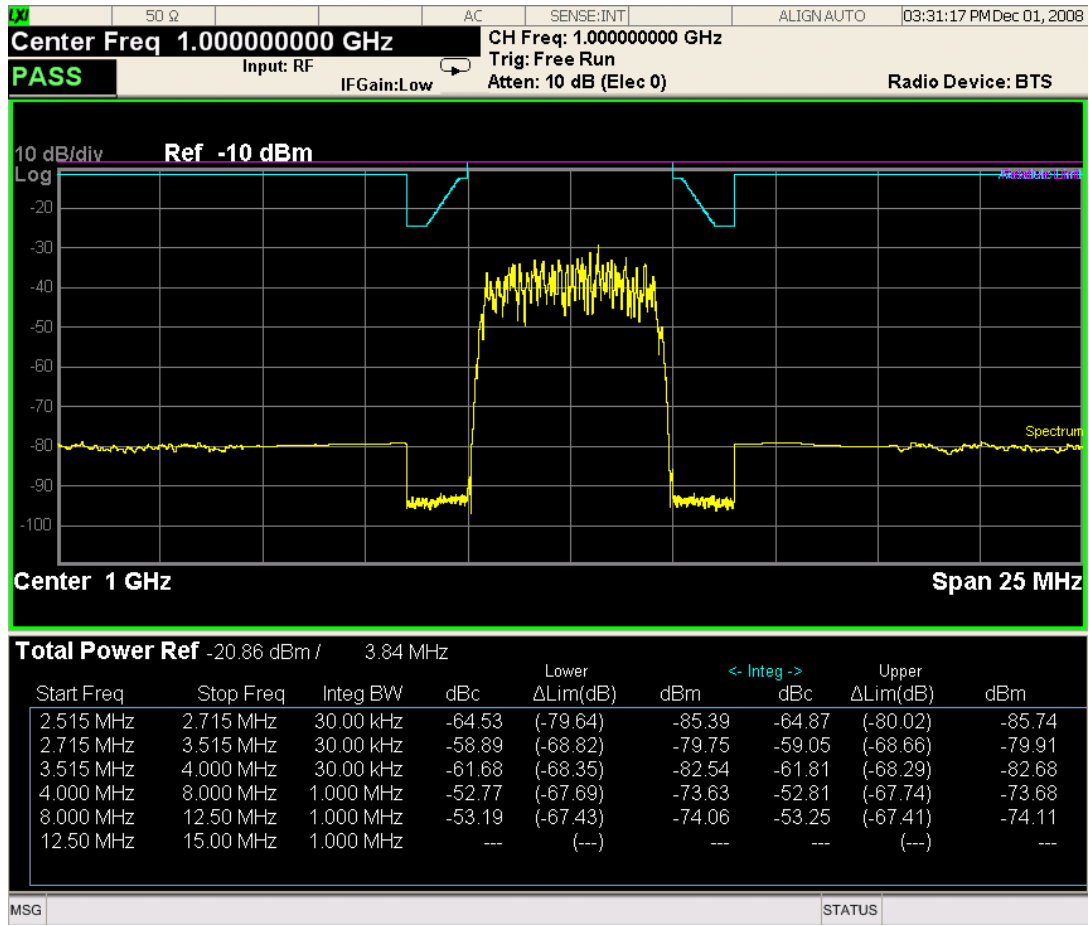

For WLAN 802.11ac (80 + 80 MHz), power readouts of both of the carriers are displayed in the lower result window.

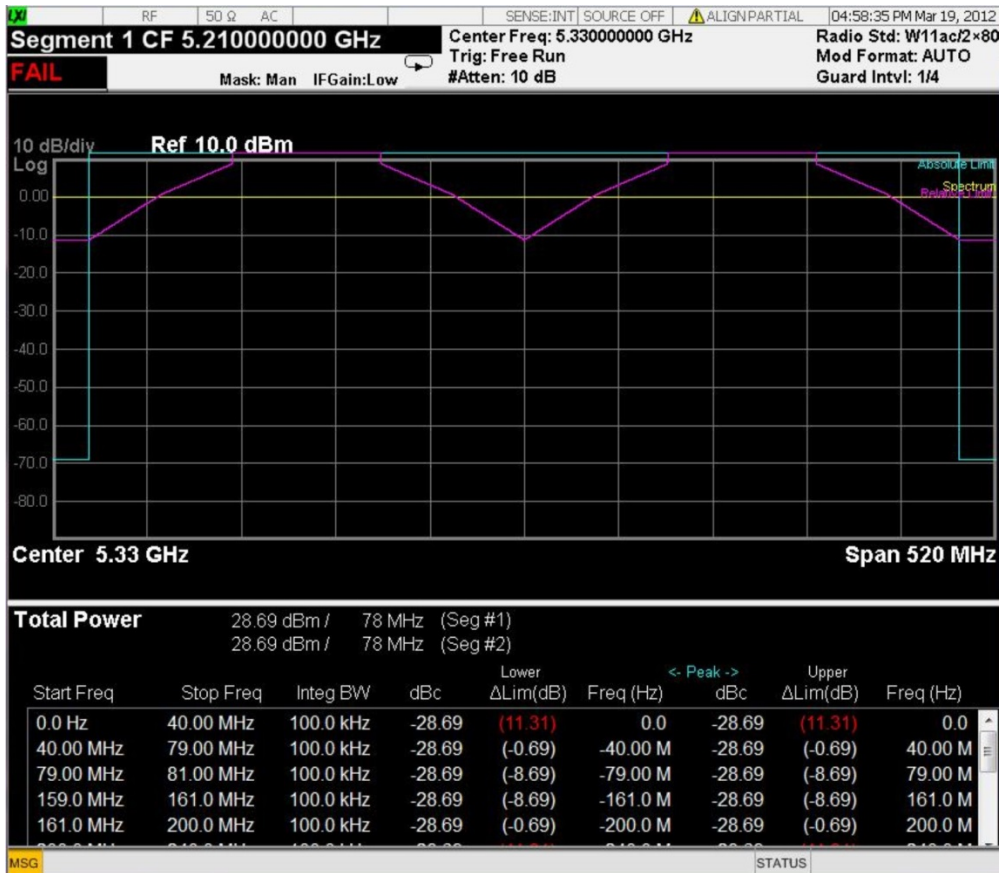

### Trace Window

Corresponding Trace      yellow - Combined trace from carrier and each offset

### Results Window

Name	Corresponding Results
Total Pwr Ref	n=1 2nd element Absolute power at the reference area.
	Channel Integration Bandwidth
Start (Hz)	Start frequency for offset
Stop (Hz)	Stop frequency for offset
Meas BW (Hz)	Measurement bandwidth for offset
Lower Integ (dBc)	Relative integrated power on the negative offset
Lower ΔLim (dB)	Minimum margin from limit line which is decided by Fail Mask setting on the negative offset
Lower Integ (dBm)	Absolute integrated power on the negative offset

Name	Corresponding Results
Upper Integ (dBc)	Relative integrated power on the positive offset
Upper ΔLim (dB)	Minimum margin from limit line which is decided by Fail Mask setting on the positive offset
Upper Integ (dBm)	Absolute integrated power on the positive offset

Integrated Power (PSD Ref)

"Trace Window" on page 1220

"Results Window" on page 1220

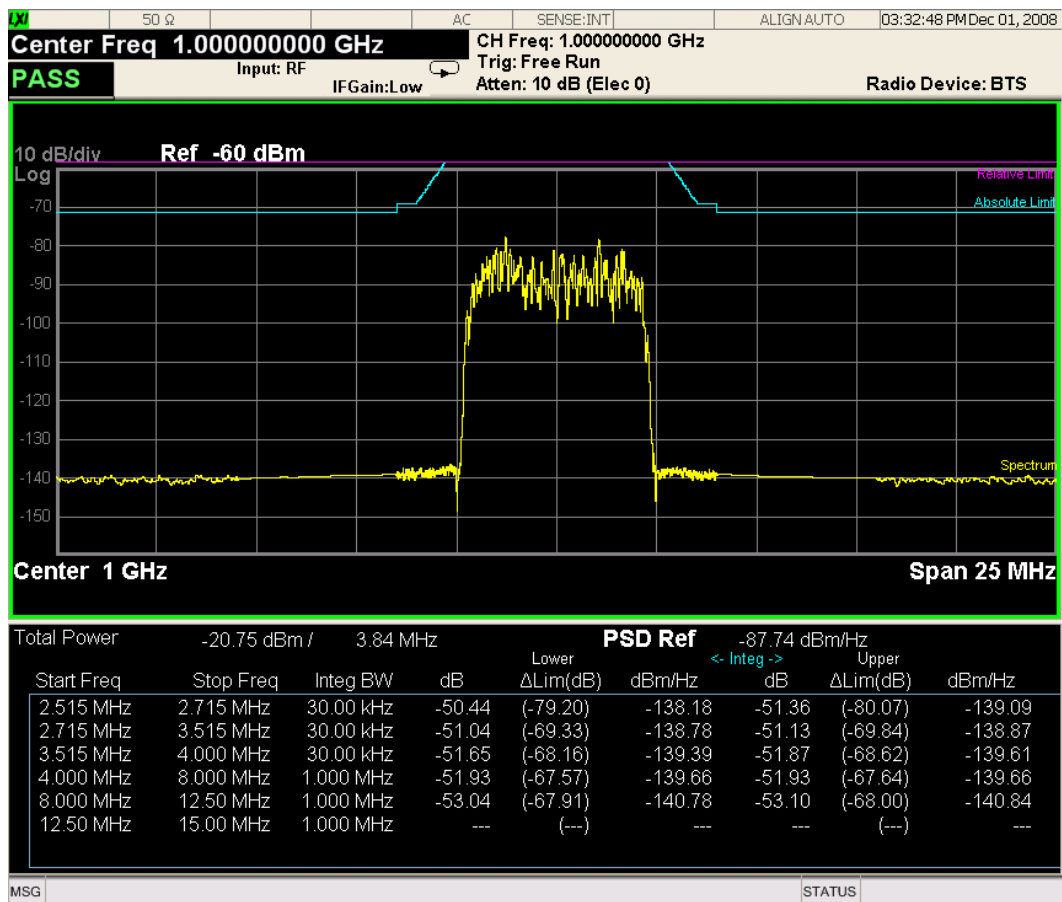



For WLAN 802.11 ac (80 + 80 MHz), power readouts of both of the carriers are displayed in the lower result window.

10 Spectrum Emission Mask Measurement  
View/Display

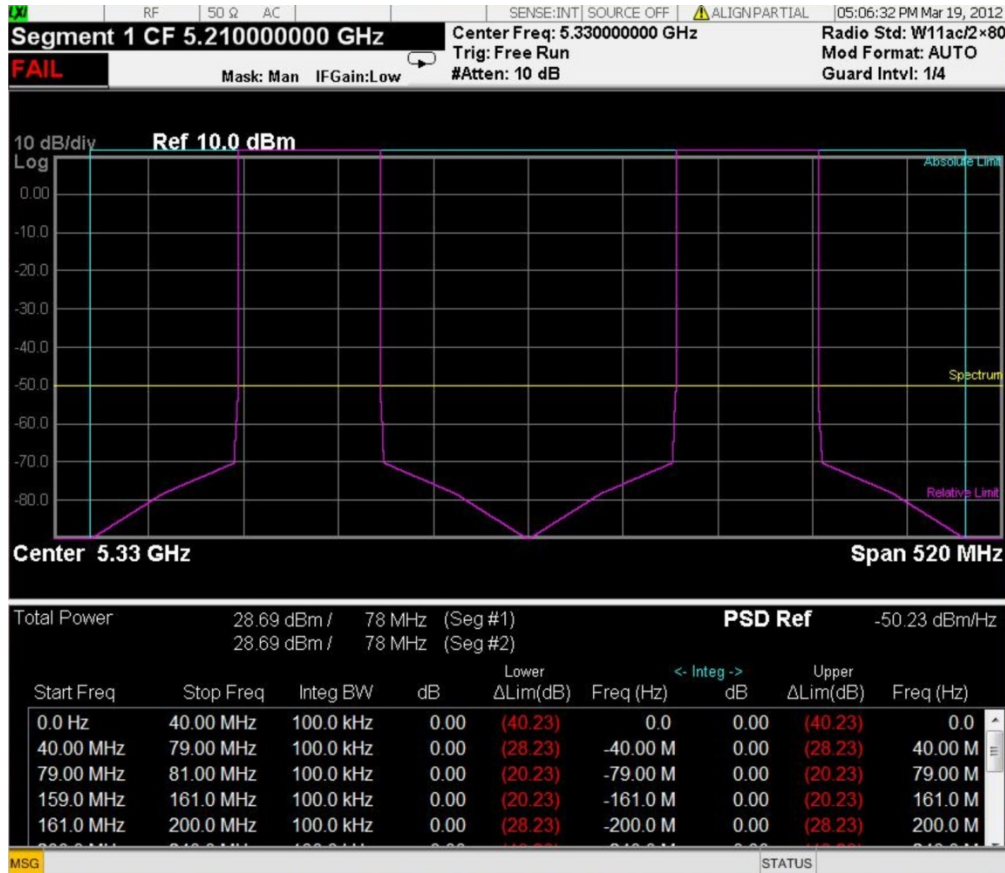

Trace Window

Corresponding Trace                      yellow - Combined trace from carrier and each offset

Results Window

Name	Corresponding Results
Total Pwr	n=1 2nd element Absolute power at the reference area.
	Channel Integration Bandwidth
PSD Ref	n=5 1st element Power spectral density reference at the reference area
Start (Hz)	Start frequency for offset
Stop (Hz)	Stop frequency for offset
Meas BW (Hz)	Measurement bandwidth for offset
Lower (dB)	Relative power spectrum density of the negative offset
Lower ΔLim (dB)	Minimum margin from limit line which is decided by Fail Mask setting on the negative offset



Name	Corresponding Results
Lower (dBm/Hz)	Absolute power spectrum density of the negative offset
Upper (dB)	Relative power spectrum density of the positive offset
Upper ΔLim (dB)	Minimum margin from limit line which is decided by Fail Mask setting on the positive offset
Upper (dBm/Hz)	Absolute power spectrum density of the negative offset

### Integrated Power (Spectrum Pk Ref)

"Trace Window" on page 1217

"Results Window" on page 1217

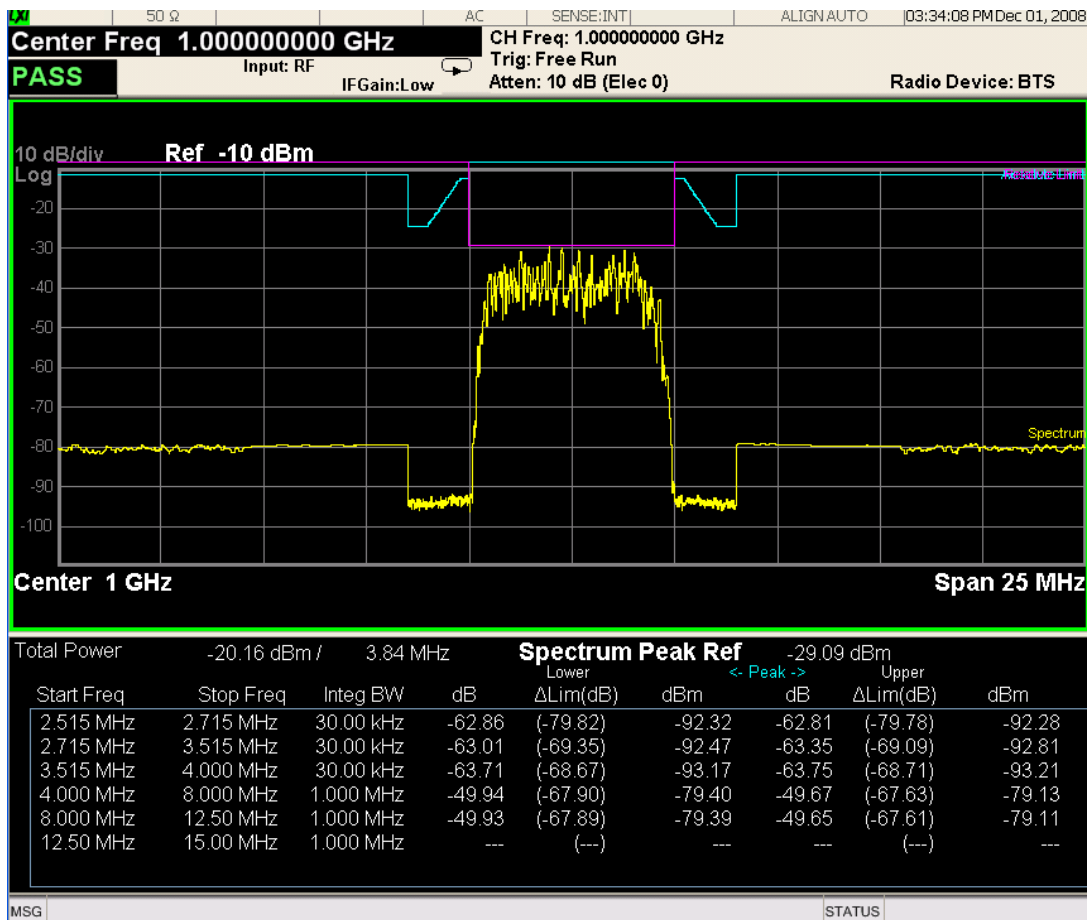

For WLAN 802.11ac (80 + 80 MHz), power readouts of both of the carriers are displayed in the lower result window.

10 Spectrum Emission Mask Measurement  
View/Display



Trace Window

Corresponding Trace                      yellow - Combined trace from carrier and each offset

Results Window

Name	Corresponding Results
Total Pwr	Absolute power at the reference area.
	Channel Integration Bandwidth
Spectrum Peak Ref	n=5 1st element
	Peak power at the reference area
Start (Hz)	Start frequency for offset
Stop (Hz)	Stop frequency for offset
Meas BW (Hz)	Measurement bandwidth for offset
Lower Peak (dB)	Relative peak power on minimum margin point of the negative offset
Lower Δlim (dB)	Minimum margin from limit line which is decided by Fail Mask setting on the negative offset

Name	Corresponding Results
Lower Peak (dBm)	Absolute peak power on minimum margin point of the negative offset
Upper Peak (dB)	Relative peak power on minimum margin point of the positive offset
Upper Δlim (dB)	Minimum margin from limit line which is decided by Fail Mask setting on the positive offset
Upper Peak (dBm)	Absolute peak power on minimum margin point of the positive offset

Key Path	View/Display
Initial S/W Revision	Prior to A.02.00

## Limit Lines

Toggles the limit lines display function for the spectrum emission mask measurements On and Off.

Key Path	View/Display
Mode	SA, WCDMA, C2K, WIMAX OFDMA, TD-SCDMA, 1xEVDO, DTMB (CTTB), DVB-T/H, ISDB-T, CMMB, LTE, LTE-TDD, Digital Cable TV, WLAN, MSR, LTEAFDD, LTEATDD
<b>Remote Command</b>	:CALCulate:SEMask:LLINE:STATE ON OFF 1 0 :CALCulate:SEMask:LLINE:STATE?
<b>Example</b>	CALC:SEM:LLIN:STAT OFF CALC:SEM:LLIN:STAT?
Notes	You must be in the mode that includes SEM measurement to use this command. Use :INSTrument:SElect to set the mode.
Preset	ON
State Saved	Saved in instrument state.
Range	On Off
Initial S/W Revision	Prior to A.02.00
Modified at S/W Revision	A.02.00, A.03.00



## 11 Modulation Analysis Measurement

The Modulation Analysis measurement provides an overall indication of the performance of the transmitter of the UUT. For more details, see "[Modulation Analysis Measurement Description](#)" on [page 1242](#). For measurement results and views, see "[View/Display](#)" on [page 1504](#).

This topic contains the following sections:

["Measurement Commands for Modulation Analysis"](#) on [page 1226](#)

["Remote Command Results for Modulation Analysis Measurements"](#) on [page 1227](#)

## Measurement Commands for Modulation Analysis

```
:CONFigure:EVM  
:CONFigure:EVM:NDEFault  
:INITiate:EVM  
:FETCh:EVM[n]?  
:READ:EVM[n]?  
:MEASure:EVM[n]
```

For more measurement related commands, see the SENSE subsystem, and the section "[Remote Measurement Functions](#)" on page 1268.

## Remote Command Results for Modulation Analysis Measurements

Index: n	Results Returned
0	Returns unprocessed I/Q trace data of Capture Interval, as a series of trace point values. The I values are listed first in each pair, using the 0 through even-indexed values. The Q values are the odd-indexed values.
1 (or not specified)	<p>Returns the following comma-separated scalar results:</p> <ol style="list-style-type: none"> <li>1. <b>Averaged Total RMS RCE (EVM) in dB</b> – a floating point number in dB</li> <li>2. <b>Averaged Total RMS RCE (EVM) in %</b> – a floating point number in percentage</li> <li>3. <b>Max Total RMS RCE (EVM) in dB</b> – a floating point number in dB</li> <li>4. <b>Max Total RMS RCE (EVM) in %</b> – a floating point number in percentage</li> <li>5. <b>Standard Deviation of Total RMS RCE (EVM) in dB</b> – a floating point number in dB</li> <li>6. <b>Standard Deviation of Total RMS RCE (EVM) in %</b> – a floating point number in percentage</li> <li>7. <b>Averaged Peak RMS RCE (EVM) in dB</b> – a floating point number in dB. This is a result of composite subcarriers in each symbol.</li> <li>8. <b>Averaged Peak RMS RCE (EVM) in %</b> – a floating point number in percentage. This is a result of composite subcarriers in each symbol.</li> <li>9. <b>Max Peak RMS RCE (EVM) in dB</b> – a floating point number in dB. This is a result of composite subcarriers in each symbol.</li> <li>10. <b>Max Peak RMS RCE (EVM) in %</b> – a floating point number in percentage. This is a result of composite subcarriers in each symbol.</li> <li>11. <b>Max Peak RMS RCE Symbol Number</b> – an integer number at which the peak RCE is detected.</li> <li>12. <b>Max Peak RMS RCE Subcarrier Number</b> – an integer number at which the peak RCE is detected</li> <li>13. <b>Standard Deviation of Peak RMS RCE (EVM) in dB</b> – a floating point number in dB. This is a result of composite subcarriers in each symbol.</li> <li>14. <b>Standard Deviation of Peak RMS RCE (EVM) in %</b> – a floating point number in percentage. This is a result of composite subcarriers in each symbol.</li> <li>15. <b>Averaged Pilot RCE in dB</b> – a floating point number in dB.</li> <li>16. <b>Averaged Pilot RCE in %</b> – a floating point number in percentage.</li> <li>17. <b>Max Pilot RCE in dB</b> – a floating point number in dB.</li> <li>18. <b>Max Pilot RCE in %</b> – a floating point number in percentage.</li> <li>19. <b>Standard Deviation of Pilot RCE in dB</b> – a floating point number in dB.</li> <li>20. <b>Standard Deviation of Pilot RCE in %</b> – a floating point number in percentage.</li> <li>21. <b>Averaged RMS RCE of Unmodulated subcarriers in dB</b> – a floating point number in dB. This measurement is based on the requirement of IEEE Std 802.16 2004-Cor1, section 8.4.12.3.4.</li> <li>22. <b>Averaged RMS RCE of Unmodulated subcarriers in %</b> – a floating point number in %. This measurement is based on the requirement of IEEE Std 802.16 2004-Cor1, section 8.4.12.3.4.</li> <li>23. <b>Max RMS RCE of Unmodulated subcarriers in dB</b> – a floating point number in dB.</li> <li>24. <b>Max RMS RCE of Unmodulated subcarriers in %</b> – a floating point number in %.</li> <li>25. <b>Standard Deviation of RMS RCE of Unmodulated subcarriers in dB</b> – a floating point</li> </ol>

Index: n	Results Returned
	number in dB.
	<b>26. Standard Deviation of RMS RCE of Unmodulated subcarriers in %</b> - a floating point number in %.
	<b>27. Averaged RMS Frequency Error</b> - a floating point number in Hz.
	<b>28. Max RMS Frequency Error</b> - a floating point number in Hz.
	<b>29. Standard Deviation of Frequency Error</b> - a floating point number in Hz.
	<b>30. Averaged IQ Origin Offset</b> - a floating point number in dB.
	<b>31. Max IQ Origin Offset</b> - a floating point number in dB.
	<b>32. Standard Deviation of IQ Origin Offset</b> - a floating point number in dB.
	<b>33. Averaged Symbol Clock Error</b> - a floating point number in ppm.
	<b>34. Max Symbol Clock Error</b> - a floating point number in ppm.
	<b>35. Standard Deviation of Symbol Clock Error</b> - a floating point number in ppm.
	<b>36. Averaged Sync Correlation</b> - a floating point number with no units which denotes an indicator of the synchronization.
	<b>37. Max Sync Correlation</b> - a floating point number with no units which denotes an indicator of the synchronization.
	<b>38. Standard Deviation of Sync Correlation</b> - a floating point number with no units which denotes an indicator of the synchronization.
	<b>39. Averaged Time Offset</b> - a floating point number in seconds.
	<b>40. Max Time Offset</b> - a floating point number in seconds.
	<b>41. Standard Deviation of Time Offset</b> - a floating point number in seconds.
	<b>42. Averaged RSSI</b> - a floating point number in dBm.
	<b>43. Max RSSI</b> - a floating point number in dBm
	<b>44. Standard Deviation of RSSI</b> - a floating point number in dBm.
	<b>45. Averaged FFT Total Power</b> - a floating point number in dBm.
	<b>46. Max FFT Total Power</b> - a floating point number in dBm.
	<b>47. Standard Deviation of FFT Total Power</b> - a floating point number in dBm.
	<b>48. Channel power</b> - a floating number in dBm.
	<b>49. OBW</b> - a floating number in Hz
	<b>50. PRBS</b> - an integer number
	<b>51. IDCell</b> - an integer number
	<b>52. Segment</b> - an integer number
	<b>53. Mean Transmit Power</b> - a floating point number in dBm.
	<b>54. Nominal BW</b> - a floating point number in Hz.
	<b>55. Abs Max Subcarrier Power (dBm)</b> - a floating point number in dBm.
	<b>56. Abs Max Subcarrier Power (dBc)</b> - a floating point number in dBc.
	<b>57. Abs Max Subcarrier Power to Upper Limit</b> - a floating point number in dB.
	<b>58. Abs Max Subcarrier Power Index</b> - an integer number.
	<b>59. Abs Min Subcarrier Power (dBm)</b> - a floating point number in dBm.
	<b>60. Abs Min Subcarrier Power (dBc)</b> - a floating point number in dBc.



Index: n	Results Returned
	<b>61. Abs Min Subcarrier Power to Lower Limit</b> – a floating point number in dB.
	<b>62. Abs Min Subcarrier Power Index</b> – an integer number.
	<b>63. Diff Max Subcarrier Power</b> – a floating point number in dB.
	<b>64. Diff Max Subcarrier Power to Upper Limit</b> – a floating point number in dB.
	<b>65. Diff Max Subcarrier Power Index</b> – an integer number.
	<b>66. Diff Min Subcarrier Power</b> – a floating point number in dB.
	<b>67. Diff Min Subcarrier Power to Lower Limit</b> – a floating point number in dB.
	<b>68. Diff Min Subcarrier Power Index</b> – an integer number.
	<b>69. Sampling Frequency</b> – a floating point number in Hz.
	<b>70. Averaged Preamble RCE (EVM) in dB</b> – a floating point number in dB. If Radio Device is MS, returns 999.0.
	<b>71. Averaged Preamble RCE (EVM) in %</b> – a floating point number in percentage. If Radio Device is MS, returns 999.0.
	<b>72. Max Preamble RCE (EVM) in dB</b> – a floating point number in dB. If Radio Device is MS, returns 999.0.
	<b>73. Max Preamble RCE (EVM) in %</b> – a floating point number in percentage. If Radio Device is MS, returns 999.0.
	<b>74. Standard Deviation of Preamble RCE (EVM) in dB</b> – a floating point number in dB. If Radio Device is MS, Average State is OFF, or Average Number is 1, returns 0.
	<b>75. Standard Deviation of Preamble RCE (EVM) in %</b> – a floating point number in percentage. If Radio Device is MS, Average State is OFF, or Average Number is 1, returns -999.0.
	<b>76. Averaged Preamble Physical CINR for Reuse type 1</b> – a floating point number in dB. If Radio Device is MS, returns -999.0.
	<b>77. Max Preamble PCINR for R1</b> – a floating point number in dB. If Radio Device is MS, returns -999.0.
	<b>78. Standard Deviation of Preamble PCINR for R1</b> – a floating point number in dB. If Radio Device is MS, Average State is OFF, or Average Number is 1, returns -999.0.
	<b>79. Averaged Preamble PCINR for Reuse type 3</b> – a floating point number in dB. When the signal does not have a preamble, returns -999.0.
	<b>80. Max Preamble PCINR for R3</b> – a floating point number in dB. When the signal does not have a preamble, returns -999.0.
	<b>81. Standard Deviation of Preamble PCINR for Reuse type 3</b> – a floating point number in dB. If Radio Device is MS, Average State is OFF, or Average Number is 1, returns -999.0.
	82. Reserved in future use.
	83. Reserved in future use.
	84. Reserved in future use.
	85. Reserved in future use.
	86. Reserved in future use.
	87. Reserved in future use.
	88. Reserved in future use.
	89. Reserved in future use.
	90. Reserved in future use.

Index: n	Results Returned
	<p><b>91. Averaged I/Q Timing Skew</b> – a floating point number in sec.</p> <p><b>92. Max I/Q Timing Skew</b> – a floating point number in sec.</p> <p><b>93. Standard Deviation of I/Q Timing Skew</b> – a floating point number in sec. If Average State is OFF or Average Number is 1, returns -999.0.</p> <p><b>94. Averaged Quadrature Error</b> – a floating point number in degrees.</p> <p><b>95. Max Quad Error</b> – a floating point number in degrees.</p> <p><b>96. Standard Deviation of Quad Error</b> – a floating point number in degrees. If Average State is OFF or Average Number is 1, returns -999.0.</p> <p><b>97. Averaged Gain Imbalance</b> – a floating point number in dB.</p> <p><b>98. Max Gain Imbalance</b> – a floating point number in dB.</p> <p><b>99. Standard Deviation of Gain Imbalance</b> – a floating point number in dB. If Average State is OFF or Average Number is 1, returns -999.0.</p> <p><b>100. Averaged Preamble Power Boost</b> – a floating point number in dB. When the signal does not have a preamble, returns -999.0.</p> <p><b>101. Max Preamble Power Boost</b> – a floating point number in dB. When the signal does not have a preamble, returns -999.0.</p> <p>102. Reserved for future use.</p> <p><b>103. Averaged Number of Preamble Errors</b> – a floating point number which denotes number of symbols whose phase error exceeds 45 degrees. When the signal does not have a preamble, returns 999.</p> <p><b>104. Max Preamble Peak Phase Error</b> – an interger number Which denotes number of symbols whose phase error exceeds 45 degrees. When the signal does not have a preamble, returns 999.</p> <p>105. Reserved for future use.</p>
2	<p>Symbol Error trace  returns series of floating point numbers (in dB) that represent each sample in the EVM trace of used subcarriers and symbols in measured zone. The order of the trace is as follows:</p> <p>1st number: a value of 1st subcarrier/1st symbol</p> <p>2nd number: a value of 2nd subcarrier/1st symbol</p> <p>...</p> <p>Nsub-th number:a value of Nsub-th subcarrier/1st symbol</p> <p>(Nsub+1)th number:a value of 1st subcarrier/2nd symbol</p> <p>...</p> <p>(Nsym*Nsub)th number:a value of Nsub-th subcarrier/Nsym-th sym</p> <p>Where Nsub denotes number of used subcarriers and Nsym denotes number of symbols of the measured zone.</p>
3	<p>RMS Symbol Error vs Subcarrier returns series of floating point numbers (in dB) that represent error vector RMS'ed across symbols vs subcarrier. The order of the trace is as follows:</p> <p>1st number: a value of 1st subcarrier</p> <p>2nd number: a value of 2nd subcarrier</p> <p>...</p> <p>Nsub-th number:a value of Nsub-th subcarrier</p>

Index: n	Results Returned
4	<p>RMS Symbol Error vs Symbol returns series of floating point numbers (in dB) that represent error vector RMS'ed across subcarriers vs symbol. The order of the trace is as follows:</p> <p>1st number: a value of 1st symbol</p> <p>2nd number: a value of 2nd symbol</p> <p>...</p> <p>Nsym-th number: a value of Nsym-th symbol</p>
5	<p>Symbol Power trace  returns series of floating point numbers (in dBm) that represent each sample in the symbol power trace of used subcarriers and symbols in measured zone. The order of the trace is as follows:</p> <p>1st number: a value of 1st subcarrier/1st symbol</p> <p>2nd number: a value of 2nd subcarrier/1st symbol</p> <p>...</p> <p>Nsub-th number: a value of Nsub-th subcarrier/1st symbol</p> <p>(Nsub+1)th number: a value of 1st subcarrier/2nd symbol</p> <p>...</p> <p>(Nsym*Nsub)th number: a value of Nsub-th subcarrier/Nsym-th sym</p> <p>Where Nsub denotes number of used subcarriers and Nsym denotes number of symbols of the measured zone.</p>
6	<p>RMS Symbol Power vs Subcarrier returns series of floating point numbers (in dBm) that represent symbol power RMS'ed across symbols vs subcarrier. The order of the trace is as follows:</p> <p>1st number: a value of 1st subcarrier</p> <p>2nd number: a value of 2nd subcarrier</p> <p>...</p> <p>Nsub-th number: a value of Nsub-th subcarrier</p>
7	<p>RMS Symbol Power vs Symbol returns series of floating point numbers (in dBm) that represent symbol power RMS'ed across subcarriers vs symbol. The order of the trace is as follows:</p> <p>1st number: a value of 1st symbol</p> <p>2nd number: a value of 2nd symbol</p> <p>...</p> <p>Nsym-th number: a value of Nsym-th symbol</p>
8	<p>IQ measured trace returns series of floating point numbers that alternately represent I and Q pairs of the corrected measured trace. The magnitude of each I and Q pair are normalized to 1.0 if "Normalized" is set to ON. The first number is the I sample of symbol 0 decision point and the second number is the Q sample of symbol 0 decision point. The order of the trace is as follows:</p> <p>1st number: a value of I-ch of 1st subcarrier/1st symbol</p> <p>2nd number: a value of Q-ch of 1st subcarrier/1st symbol</p> <p>3rd number: a value of I-ch of 2nd subcarrier/1st symbol</p> <p>4th number: a value of Q-ch of 2nd subcarrier/1st symbol</p> <p>...</p>

Index: n	Results Returned
	<p>(<math>N_{sub} * 2 - 1</math>)-th number: a value of I-ch of <math>N_{sub}</math>-th subcar/1st symbol  (<math>N_{sub} * 2</math>)-th number: a value of Q-ch of <math>N_{sub}</math>-th subcar/1st symbol  (<math>N_{sub} * 2 + 1</math>)-th number: a value of I-ch of <math>N_{sub}</math>-th subcar/2nd symbol  (<math>N_{sub} * 2 + 2</math>)-th number: a value of Q-ch of <math>N_{sub}</math>-th subcar/2nd symbol  ...  (<math>N_{sym} * N_{sub} * 2 - 1</math>)-th number: a value of I-ch of <math>N_{sub}</math>-th subcarr/<math>N_{sym}</math>-th sym  (<math>N_{sym} * N_{sub} * 2</math>)-th number: a value of Q-ch of <math>N_{sub}</math>-th subcarr/<math>N_{sym}</math>-th sym  Where <math>N_{sub}</math> denotes number of used subcarriers and <math>N_{sym}</math> denotes number of symbols of the measured zone.</p>
9	Channel Frequency Response (Spectral Flatness) – floating point numbers which denote the equalizer channel frequency response, which is the reciprocal of the equalizer frequency response. This has one point per subcarrier. The equalizer frequency response is normally estimated from the channel estimation sequence portion of the OFDMA preamble.
10	Spectral Flatness Upper Limit Mask – floating point numbers which denote the upper limit mask trace of spectral flatness.
11	Spectral Flatness Lower Limit Mask – floating point numbers which denote the lower limit mask trace of spectral flatness.
12	Adjacent subcarrier power difference in dB (Spectral Flatness Diff) – computed by scanning through the Channel Frequency Response trace and taking the ratio of each bin to the previous bin. If the signal does not use all subcarriers, the trace assumes a smooth interpolation between the subcarriers that are used.
13	Spectral Flatness Diff Upper Limit Mask – floating point numbers which denote the upper limit mask trace of spectral flatness diff.
14	Spectral Flatness Diff Lower Limit Mask – floating point numbers which denote the lower limit mask trace of spectral flatness diff.
15	Preamble Frequency Error – shows the total frequency error during the preamble portion of the OFDMA burst. Preamble Frequency Error is sampled at 256 times the subcarrier spacing.
16	Common Pilot Error – shows the complex difference between the measured and ideal pilot subcarrier symbols. Residual phase and frequency settling that occurs following the preamble is measured via the Common Pilot Error.
17	<p>Data Burst Info – shows summary data for the active Data Burst. The shown Data Burst Number is designated by the parameter :CALCulate:EVM:INFormation:BURSt?. The array consists of following elements:</p> <ol style="list-style-type: none"> <li>1. Burst Type(int)</li> <li>2. 0 = Normal, 1 = FCH, 2 = DL-MAP</li> <li>3. Data Modulation Format</li> <li>4. 0 = QPSK-1/2</li> <li>5. 1 = QPSK-3/4</li> <li>6. 9 = QPSK-Unknown</li> <li>7. 10 = 16QAM-1/2</li> <li>8. 11 = 16QAM-3/4</li> <li>9. 19 = 16QAM-Unknown</li> </ol>

Index: n	Results Returned
	10. 20 = 64QAM-1/2
	11. 21 = 64QAM-2/3
	12. 22 = 64QAM-3/4
	13. 29 = 64QAM-Unknown
	14. Boosting Level in dB
	15. Subchannel Offset
	16. Subchannel Interval
	17. Symbol Offset
	18. Symbol Interval
	19. Burst power in dBm
	20. RCE of whole burst in dB
	21. RCE of data portion in dB
	22. Burst Pilot Power in dBm. When Radio Device is BTS, returns -999.0.
18	Demod Bit trace – shows Demod Bit Trace of the measured zone or burst.
19	FFT Spectrum trace – shows FFT Spectrum Trace
20	Time Domain trace – shows the time domain power trace of the burst.
21	<p>Spectral Flatness results of each offset – summary data for spectral flatness results of each offset</p> <ol style="list-style-type: none"> <li>1. <b>Abs Max Subcarrier Power (dBm) for Offset A Negative Side</b> – a floating point number in dBm. If Offset A is off, this returns -999.0.</li> <li>2. <b>Abs Max Subcarrier Power (dBc) for Offset A Negative Side</b> – a floating point number in dBc. If Offset A is off, this returns -999.0.</li> <li>3. <b>Abs Max Subcarrier Power to Upper Limit for Offset A Negative Side</b> – a floating point number in dB. If Offset A is off or Offset Side is POS, this returns -999.0.</li> <li>4. <b>Abs Max Subcarrier Power Index for Offset A Negative Side</b> – an integer number. If Offset A is off, this returns -999.0.</li> <li>5. <b>Abs Min Subcarrier Power (dBm) for Offset A Negative Side</b> – a floating point number in dBm. If Offset A is off, this returns 999.0.</li> <li>6. <b>Abs Min Subcarrier Power (dBc) for Offset A Negative Side</b> – a floating point number in dBc. If Offset A is off, this returns 999.0.</li> <li>7. <b>Abs Min Subcarrier Power to Lower Limit for Offset A Negative Side</b> – a floating point number in dB. If Offset A is off or Offset Side is POS, this returns 999.0.</li> <li>8. <b>Abs Min Subcarrier Power Index for Offset A Negative Side</b> – an integer number. If Offset A is off, this returns -999.0.</li> <li>9. <b>Abs Max Subcarrier Power (dBm) for Offset A Positive Side</b> – a floating point number in dBm. If Offset A is off, this returns -999.0.</li> <li>10. <b>Abs Max Subcarrier Power (dBc) for Offset A Positive Side</b> – a floating point number in dBc. If Offset A is off, this returns -999.0.</li> <li>11. <b>Abs Max Subcarrier Power to Upper Limit for Offset A Positive Side</b> – a floating point number in dB. If Offset A is off or Offset Side is NEG, this returns -999.0.</li> <li>12. <b>Abs Max Subcarrier Power Index for Offset A Positive Side</b> – an integer number. If Offset A is off, this returns -999.0.</li> </ol>

Index: n	Results Returned
	<b>13. Abs Min Subcarrier Power (dBm) for Offset A Positive Side</b> - a floating point number in dBm. If Offset A is off, this returns 999.0.
	<b>14. Abs Min Subcarrier Power (dBc) for Offset A Positive Side</b> - a floating point number in dBc. If Offset A is off, this returns 999.0.
	<b>15. Abs Min Subcarrier Power to Lower Limit for Offset A Positive Side</b> - a floating point number in dB. If Offset A is off or Offset Side is NEG, this returns 999.0.
	<b>16. Abs Min Subcarrier Power Index for Offset A Positive Side</b> - an integer number. If Offset A is off, this returns -999.0.
	<b>17. Abs Max Subcarrier Power (dBm) for Offset B Negative Side</b> - a floating point number in dBm. If Offset B is off, this returns -999.0.
	<b>18. Abs Max Subcarrier Power (dBc) for Offset B Negative Side</b> - a floating point number in dBc. If Offset B is off, this returns -999.0.
	<b>19. Abs Max Subcarrier Power to Upper Limit for Offset B Negative Side</b> - a floating point number in dB. If Offset B is off or Offset Side is POS, this returns -999.0.
	<b>20. Abs Max Subcarrier Power Index for Offset B Negative Side</b> - an integer number. If Offset B is off, this returns -999.0.
	<b>21. Abs Min Subcarrier Power (dBm) for Offset B Negative Side</b> - a floating point number in dBm. If Offset B is off, this returns 999.0.
	<b>22. Abs Min Subcarrier Power (dBc) for Offset B Negative Side</b> - a floating point number in dBc. If Offset B is off, this returns 999.0.
	<b>23. Abs Min Subcarrier Power to Lower Limit for Offset B Negative Side</b> - a floating point number in dB. If Offset B is off or Offset Side is POS, this returns 999.0.
	<b>24. Abs Min Subcarrier Power Index for Offset B Negative Side</b> - an integer number. If Offset B is off, this returns -999.0.
	<b>25. Abs Max Subcarrier Power (dBm) for Offset B Positive Side</b> - a floating point number in dBm. If Offset B is off, this returns -999.0.
	<b>26. Abs Max Subcarrier Power (dBc) for Offset B Positive Side</b> - a floating point number in dBc. If Offset B is off, this returns -999.0.
	<b>27. Abs Max Subcarrier Power to Upper Limit for Offset B Positive Side</b> - a floating point number in dB. If Offset B is off or Offset Side is NEG, this returns -999.0.
	<b>28. Abs Max Subcarrier Power Index for Offset B Positive Side</b> - an integer number. If Offset B is off, this returns -999.0.
	<b>29. Abs Min Subcarrier Power (dBm) for Offset B Positive Side</b> - a floating point number in dBm. If Offset B is off, this returns 999.0.
	<b>30. Abs Min Subcarrier Power (dBc) for Offset B Positive Side</b> - a floating point number in dBc. If Offset B is off, this returns 999.0.
	<b>31. Abs Min Subcarrier Power to Lower Limit for Offset B Positive Side</b> - a floating point number in dB. If Offset B is off or Offset Side is NEG, this returns 999.0.
	<b>32. Abs Min Subcarrier Power Index for Offset B Positive Side</b> - an integer number. If Offset B is off, this returns -999.0.
	<b>33. Abs Max Subcarrier Power (dBm) for Offset C Negative Side</b> - a floating point number in dBm. If Offset C is off, this returns -999.0.
	<b>34. Abs Max Subcarrier Power (dBc) for Offset C Negative Side</b> - a floating point number in dBc. If Offset C is off, this returns -999.0.

Index: n	Results Returned
	<b>35. Abs Max Subcarrier Power to Upper Limit for Offset C Negative Side</b> – a floating point number in dB. If Offset C is off or Offset Side is POS, this returns –999.0.
	<b>36. Abs Max Subcarrier Power Index for Offset C Negative Side</b> – an integer number. If Offset C is off, this returns –999.0.
	<b>37. Abs Min Subcarrier Power (dBm) for Offset C Negative Side</b> - a floating point number in dBm. If Offset C is off, this returns 999.0.
	<b>38. Abs Min Subcarrier Power (dBc) for Offset C Negative Side</b> - a floating point number in dBc. If Offset C is off, this returns 999.0.
	<b>39. Abs Min Subcarrier Power to Lower Limit for Offset C Negative Side</b> – a floating point number in dB. If Offset C is off or Offset Side is POS, this returns 999.0.
	<b>40. Abs Min Subcarrier Power Index for Offset C Negative Side</b> – an integer number. If Offset C is off, this returns –999.0.
	<b>41. Abs Max Subcarrier Power (dBm) for Offset C Positive Side</b> – a floating point number in dBm. If Offset C is off, this returns –999.0.
	<b>42. Abs Max Subcarrier Power (dBc) for Offset C Positive Side</b> – a floating point number in dBc. If Offset C is off, this returns –999.0.
	<b>43. Abs Max Subcarrier Power to Upper Limit for Offset C Positive Side</b> – a floating point number in dB. If Offset C is off or Offset Side is NEG, this returns –999.0.
	<b>44. Abs Max Subcarrier Power Index for Offset C Positive Side</b> – an integer number. If Offset C is off, this returns –999.0.
	<b>45. Abs Min Subcarrier Power (dBm) for Offset C Positive Side</b> - a floating point number in dBm. If Offset C is off, this returns 999.0.
	<b>46. Abs Min Subcarrier Power (dBc) for Offset C Positive Side</b> - a floating point number in dBc. If Offset C is off, this returns 999.0.
	<b>47. Abs Min Subcarrier Power to Lower Limit for Offset C Positive Side</b> – a floating point number in dB. If Offset C is off or Offset Side is NEG, this returns 999.0.
	<b>48. Abs Min Subcarrier Power Index for Offset C Positive Side</b> – an integer number. If Offset C is off, this returns –999.0.
	<b>49. Abs Max Subcarrier Power (dBm) for Offset D Negative Side</b> – a floating point number in dBm. If Offset D is off, this returns –999.0.
	<b>50. Abs Max Subcarrier Power (dBc) for Offset D Negative Side</b> – a floating point number in dBc. If Offset D is off, this returns –999.0.
	<b>51. Abs Max Subcarrier Power to Upper Limit for Offset D Negative Side</b> – a floating point number in dB. If Offset D is off or Offset Side is POS, this returns –999.0.
	<b>52. Abs Max Subcarrier Power Index for Offset D Negative Side</b> – an integer number. If Offset D is off, this returns –999.0.
	<b>53. Abs Min Subcarrier Power (dBm) for Offset D Negative Side</b> - a floating point number in dBm. If Offset D is off, this returns 999.0.
	<b>54. Abs Min Subcarrier Power (dBc) for Offset D Negative Side</b> - a floating point number in dBc. If Offset D is off, this returns 999.0.
	<b>55. Abs Min Subcarrier Power to Lower Limit for Offset D Negative Side</b> – a floating point number in dB. If Offset D is off or Offset Side is POS, this returns 999.0.
	<b>56. Abs Min Subcarrier Power Index for Offset D Negative Side</b> – an integer number. If Offset D is off, this returns –999.0.

Index: n	Results Returned
	<b>57. Abs Max Subcarrier Power (dBm) for Offset D Positive Side</b> – a floating point number in dBm. If Offset D is off, this returns –999.0.
	<b>58. Abs Max Subcarrier Power (dBc) for Offset D Positive Side</b> – a floating point number in dBc. If Offset D is off, this returns –999.0.
	<b>59. Abs Max Subcarrier Power to Upper Limit for Offset D Positive Side</b> – a floating point number in dB. If Offset D is off or Offset Side is NEG, this returns –999.0.
	<b>60. Abs Max Subcarrier Power Index for Offset D Positive Side</b> – an integer number. If Offset D is off, this returns –999.0.
	<b>61. Abs Min Subcarrier Power (dBm) for Offset D Positive Side</b> – a floating point number in dBm. If Offset D is off, this returns 999.0.
	<b>62. Abs Min Subcarrier Power (dBc) for Offset D Positive Side</b> – a floating point number in dBc. If Offset D is off, this returns 999.0.
	<b>63. Abs Min Subcarrier Power to Lower Limit for Offset D Positive Side</b> – a floating point number in dB. If Offset D is off or Offset Side is NEG, this returns 999.0.
	<b>64. Abs Min Subcarrier Power Index for Offset D Positive Side</b> – an integer number. If Offset D is off, this returns –999.0.
	<b>65. Abs Max Subcarrier Power (dBm) for Offset E Negative Side</b> – a floating point number in dBm. If Offset E is off, this returns –999.0.
	<b>66. Abs Max Subcarrier Power (dBc) for Offset E Negative Side</b> – a floating point number in dBc. If Offset E is off, this returns –999.0.
	<b>67. Abs Max Subcarrier Power to Upper Limit for Offset E Negative Side</b> – a floating point number in dB. If Offset E is off or Offset Side is POS, this returns –999.0.
	<b>68. Abs Max Subcarrier Power Index for Offset E Negative Side</b> – an integer number. If Offset E is off, this returns –999.0.
	<b>69. Abs Min Subcarrier Power (dBm) for Offset E Negative Side</b> – a floating point number in dBm. If Offset E is off, this returns 999.0.
	<b>70. Abs Min Subcarrier Power (dBc) for Offset E Negative Side</b> – a floating point number in dBc. If Offset E is off, this returns 999.0.
	<b>71. Abs Min Subcarrier Power to Lower Limit for Offset E Negative Side</b> – a floating point number in dB. If Offset E is off or Offset Side is POS, this returns 999.0.
	<b>72. Abs Min Subcarrier Power Index for Offset E Negative Side</b> – an integer number. If Offset E is off, this returns –999.0.
	<b>73. Abs Max Subcarrier Power (dBm) for Offset E Positive Side</b> – a floating point number in dBm. If Offset E is off, this returns –999.0.
	<b>74. Abs Max Subcarrier Power (dBc) for Offset E Positive Side</b> – a floating point number in dBc. If Offset E is off, this returns –999.0.
	<b>75. Abs Max Subcarrier Power to Upper Limit for Offset E Positive Side</b> – a floating point number in dB. If Offset E is off or Offset Side is NEG, this returns –999.0.
	<b>76. Abs Max Subcarrier Power Index for Offset E Positive Side</b> – an integer number. If Offset E is off, this returns –999.0.
	<b>77. Abs Min Subcarrier Power (dBm) for Offset E Positive Side</b> – a floating point number in dBm. If Offset E is off, this returns 999.0.
	<b>78. Abs Min Subcarrier Power (dBc) for Offset E Positive Side</b> – a floating point number in dBc. If Offset E is off, this returns 999.0.



Index: n	Results Returned
	<b>79. Abs Min Subcarrier Power to Lower Limit for Offset E Positive Side</b> – a floating point number in dB. If Offset E is off or Offset Side is NEG, this returns 999.0.
	<b>80. Abs Min Subcarrier Power Index for Offset E Positive Side</b> – an integer number. If Offset E is off, this returns –999.0.
	<b>81. Abs Max Subcarrier Power (dBm) for Offset F Negative Side</b> – a floating point number in dBm. If Offset F is off, this returns –999.0.
	<b>82. Abs Max Subcarrier Power (dBc) for Offset F Negative Side</b> – a floating point number in dBc. If Offset F is off, this returns –999.0.
	<b>83. Abs Max Subcarrier Power to Upper Limit for Offset F Negative Side</b> – a floating point number in dB. If Offset F is off or Offset Side is POS, this returns –999.0.
	<b>84. Abs Max Subcarrier Power Index for Offset F Negative Side</b> – an integer number. If Offset F is off, this returns –999.0.
	<b>85. Abs Min Subcarrier Power (dBm) for Offset F Negative Side</b> – a floating point number in dBm. If Offset F is off, this returns 999.0.
	<b>86. Abs Min Subcarrier Power (dBc) for Offset F Negative Side</b> – a floating point number in dBc. If Offset F is off, this returns 999.0.
	<b>87. Abs Min Subcarrier Power to Lower Limit for Offset F Negative Side</b> – a floating point number in dB. If Offset F is off or Offset Side is POS, this returns 999.0.
	<b>88. Abs Min Subcarrier Power Index for Offset F Negative Side</b> – an integer number. If Offset F is off, this returns –999.0.
	<b>89. Abs Max Subcarrier Power (dBm) for Offset F Positive Side</b> – a floating point number in dBm. If Offset F is off, this returns –999.0.
	<b>90. Abs Max Subcarrier Power (dBc) for Offset F Positive Side</b> – a floating point number in dBc. If Offset F is off, this returns –999.0.
	<b>91. Abs Max Subcarrier Power to Upper Limit for Offset F Positive Side</b> – a floating point number in dB. If Offset F is off or Offset Side is NEG, this returns –999.0.
	<b>92. Abs Max Subcarrier Power Index for Offset F Positive Side</b> – an integer number. If Offset F is off, this returns –999.0.
	<b>93. Abs Min Subcarrier Power (dBm) for Offset F Positive Side</b> – a floating point number in dBm. If Offset F is off, this returns 999.0.
	<b>94. Abs Min Subcarrier Power (dBc) for Offset F Positive Side</b> – a floating point number in dBc. If Offset F is off, this returns 999.0.
	<b>95. Abs Min Subcarrier Power to Lower Limit for Offset F Positive Side</b> – a floating point number in dB. If Offset F is off or Offset Side is NEG, this returns 999.0.
	<b>96. Abs Min Subcarrier Power Index for Offset F Positive Side</b> – an integer number. If Offset F is off, this returns –999.0.
	<b>97. Diff Max Subcarrier Power for Offset A Negative Side</b> – a floating point number in dB. If Offset A is off, this returns –999.0.
	<b>98. Diff Max Subcarrier Power to Upper Limit for Offset A Negative Side</b> – a floating point number in dB. If Offset A is off and Offset Side is POS, this returns –999.0.
	<b>99. Diff Max Subcarrier Power Index for Offset A Negative Side</b> – an integer number. If Offset A is off, this returns –999.
	<b>100. Diff Min Subcarrier Power for Offset A Negative Side</b> – a floating point number in dB. If Offset A is off, this returns 999.0.

Index: n	Results Returned
	<b>101. Diff Min Subcarrier Power to Lower Limit for Offset A Negative Side</b> – a floating point number in dB. If Offset A is off and Offset Side is POS, this returns –999.0.
	<b>102. Diff Min Subcarrier Power Index for Offset A Negative Side</b> – an integer number. If Offset A is off, this returns –999.0.
	<b>103. Diff Max Subcarrier Power for Offset A Positive Side</b> – a floating point number in dB. If Offset A is off, this returns –999.0.
	<b>104. Diff Max Subcarrier Power to Upper Limit for Offset A Positive Side</b> – a floating point number in dB. If Offset A is off and Offset Side is POS, this returns –999.0.
	<b>105. Diff Max Subcarrier Power Index for Offset A Positive Side</b> – an integer number. If Offset A is off, this returns –999.
	<b>106. Diff Min Subcarrier Power for Offset A Positive Side</b> – a floating point number in dB. If Offset A is off, this returns 999.0.
	<b>107. Diff Min Subcarrier Power to Lower Limit for Offset A Positive Side</b> – a floating point number in dB. If Offset A is off and Offset Side is POS, this returns –999.0.
	<b>108. Diff Min Subcarrier Power Index for Offset A Positive Side</b> – an integer number. If Offset A is off, this returns –999.0.
	<b>109. Diff Max Subcarrier Power for Offset B Negative Side</b> – a floating point number in dB. If Offset B is off, this returns –999.0.
	<b>110. Diff Max Subcarrier Power to Upper Limit for Offset B Negative Side</b> – a floating point number in dB. If Offset B is off and Offset Side is POS, this returns –999.0.
	<b>111. Diff Max Subcarrier Power Index for Offset B Negative Side</b> – an integer number. If Offset B is off, this returns –999.
	<b>112. Diff Min Subcarrier Power for Offset B Negative Side</b> – a floating point number in dB. If Offset B is off, this returns 999.0.
	<b>113. Diff Min Subcarrier Power to Lower Limit for Offset B Negative Side</b> – a floating point number in dB. If Offset B is off and Offset Side is POS, this returns –999.0.
	<b>114. Diff Min Subcarrier Power Index for Offset B Negative Side</b> – an integer number. If Offset B is off, this returns –999.0.
	<b>115. Diff Max Subcarrier Power for Offset B Positive Side</b> – a floating point number in dB. If Offset B is off, this returns –999.0.
	<b>116. Diff Max Subcarrier Power to Upper Limit for Offset B Positive Side</b> – a floating point number in dB. If Offset B is off and Offset Side is POS, this returns –999.0.
	<b>117. Diff Max Subcarrier Power Index for Offset B Positive Side</b> – an integer number. If Offset B is off, this returns –999.
	<b>118. Diff Min Subcarrier Power for Offset B Positive Side</b> – a floating point number in dB. If Offset B is off, this returns 999.0.
	<b>119. Diff Min Subcarrier Power to Lower Limit for Offset B Positive Side</b> – a floating point number in dB. If Offset B is off and Offset Side is POS, this returns –999.0.
	<b>120. Diff Min Subcarrier Power Index for Offset B Positive Side</b> – an integer number. If Offset B is off, this returns –999.0.
	<b>121. Diff Max Subcarrier Power for Offset C Negative Side</b> – a floating point number in dB. If Offset C is off, this returns –999.0.
	<b>122. Diff Max Subcarrier Power to Upper Limit for Offset C Negative Side</b> – a floating point number in dB. If Offset C is off and Offset Side is POS, this returns –999.0.

Index: n	Results Returned
	<b>123. Diff Max Subcarrier Power Index for Offset C Negative Side</b> – an integer number. If Offset C is off, this returns –999.
	<b>124. Diff Min Subcarrier Power for Offset C Negative Side</b> – a floating point number in dB. If Offset C is off, this returns 999.0.
	<b>125. Diff Min Subcarrier Power to Lower Limit for Offset C Negative Side</b> – a floating point number in dB. If Offset C is off and Offset Side is POS, this returns –999.0.
	<b>126. Diff Min Subcarrier Power Index for Offset C Negative Side</b> – an integer number. If Offset C is off, this returns –999.0.
	<b>127. Diff Max Subcarrier Power for Offset C Positive Side</b> – a floating point number in dB. If Offset C is off, this returns –999.0.
	<b>128. Diff Max Subcarrier Power to Upper Limit for Offset C Positive Side</b> – a floating point number in dB. If Offset C is off and Offset Side is POS, this returns –999.0.
	<b>129. Diff Max Subcarrier Power Index for Offset C Positive Side</b> – an integer number. If Offset C is off, this returns –999.
	<b>130. Diff Min Subcarrier Power for Offset C Positive Side</b> – a floating point number in dB. If Offset C is off, this returns 999.0.
	<b>131. Diff Min Subcarrier Power to Lower Limit for Offset C Positive Side</b> – a floating point number in dB. If Offset C is off and Offset Side is POS, this returns –999.0.
	<b>132. Diff Min Subcarrier Power Index for Offset C Positive Side</b> – an integer number. If Offset C is off, this returns –999.0.
	<b>133. Diff Max Subcarrier Power for Offset D Negative Side</b> – a floating point number in dB. If Offset D is off, this returns –999.0.
	<b>134. Diff Max Subcarrier Power to Upper Limit for Offset D Negative Side</b> – a floating point number in dB. If Offset D is off and Offset Side is POS, this returns –999.0.
	<b>135. Diff Max Subcarrier Power Index for Offset D Negative Side</b> – an integer number. If Offset D is off, this returns –999.
	<b>136. Diff Min Subcarrier Power for Offset D Negative Side</b> – a floating point number in dB. If Offset D is off, this returns 999.0.
	<b>137. Diff Min Subcarrier Power to Lower Limit for Offset D Negative Side</b> – a floating point number in dB. If Offset D is off and Offset Side is POS, this returns –999.0.
	<b>138. Diff Min Subcarrier Power Index for Offset D Negative Side</b> – an integer number. If Offset D is off, this returns –999.0.
	<b>139. Diff Max Subcarrier Power for Offset D Positive Side</b> – a floating point number in dB. If Offset D is off, this returns –999.0.
	<b>140. Diff Max Subcarrier Power to Upper Limit for Offset D Positive Side</b> – a floating point number in dB. If Offset D is off and Offset Side is POS, this returns –999.0.
	<b>141. Diff Max Subcarrier Power Index for Offset D Positive Side</b> – an integer number. If Offset D is off, this returns –999.
	<b>142. Diff Min Subcarrier Power for Offset D Positive Side</b> – a floating point number in dB. If Offset D is off, this returns 999.0.
	<b>143. Diff Min Subcarrier Power to Lower Limit for Offset D Positive Side</b> – a floating point number in dB. If Offset D is off and Offset Side is POS, this returns –999.0.
	<b>144. Diff Min Subcarrier Power Index for Offset D Positive Side</b> – an integer number. If Offset D is off, this returns –999.0.

Index: n	Results Returned
	<b>145. Diff Max Subcarrier Power for Offset E Negative Side</b> - a floating point number in dB. If Offset E is off, this returns -999.0.
	<b>146. Diff Max Subcarrier Power to Upper Limit for Offset E Negative Side</b> - a floating point number in dB. If Offset E is off and Offset Side is POS, this returns -999.0.
	<b>147. Diff Max Subcarrier Power Index for Offset E Negative Side</b> - an integer number. If Offset E is off, this returns -999.
	<b>148. Diff Min Subcarrier Power for Offset E Negative Side</b> - a floating point number in dB. If Offset E is off, this returns 999.0.
	<b>149. Diff Min Subcarrier Power to Lower Limit for Offset E Negative Side</b> - a floating point number in dB. If Offset E is off and Offset Side is POS, this returns -999.0.
	<b>150. Diff Min Subcarrier Power Index for Offset E Negative Side</b> - an integer number. If Offset E is off, this returns -999.0.
	<b>151. Diff Max Subcarrier Power for Offset E Positive Side</b> - a floating point number in dB. If Offset E is off, this returns -999.0.
	<b>152. Diff Max Subcarrier Power to Upper Limit for Offset E Positive Side</b> - a floating point number in dB. If Offset E is off and Offset Side is POS, this returns -999.0.
	<b>153. Diff Max Subcarrier Power Index for Offset E Positive Side</b> - an integer number. If Offset E is off, this returns -999.
	<b>154. Diff Min Subcarrier Power for Offset E Positive Side</b> - a floating point number in dB. If Offset E is off, this returns 999.0.
	<b>155. Diff Min Subcarrier Power to Lower Limit for Offset E Positive Side</b> - a floating point number in dB. If Offset E is off and Offset Side is POS, this returns -999.0.
	<b>156. Diff Min Subcarrier Power Index for Offset E Positive Side</b> - an integer number. If Offset E is off, this returns -999.0.
	<b>157. Diff Max Subcarrier Power for Offset F Negative Side</b> - a floating point number in dB. If Offset F is off, this returns -999.0.
	<b>158. Diff Max Subcarrier Power to Upper Limit for Offset F Negative Side</b> - a floating point number in dB. If Offset F is off and Offset Side is POS, this returns -999.0.
	<b>159. Diff Max Subcarrier Power Index for Offset F Negative Side</b> - an integer number. If Offset F is off, this returns -999.
	<b>160. Diff Min Subcarrier Power for Offset F Negative Side</b> - a floating point number in dB. If Offset F is off, this returns 999.0.
	<b>161. Diff Min Subcarrier Power to Lower Limit for Offset F Negative Side</b> - a floating point number in dB. If Offset F is off and Offset Side is POS, this returns -999.0.
	<b>162. Diff Min Subcarrier Power Index for Offset F Negative Side</b> - an integer number. If Offset F is off, this returns -999.0.
	<b>163. Diff Max Subcarrier Power for Offset F Positive Side</b> - a floating point number in dB. If Offset F is off, this returns -999.0.
	<b>164. Diff Max Subcarrier Power to Upper Limit for Offset F Positive Side</b> - a floating point number in dB. If Offset F is off and Offset Side is POS, this returns -999.0.
	<b>165. Diff Max Subcarrier Power Index for Offset F Positive Side</b> - an integer number. If Offset F is off, this returns -999.
	<b>166. Diff Min Subcarrier Power for Offset F Positive Side</b> - a floating point number in dB. If Offset F is off, this returns 999.0.

Index: n	Results Returned
	<b>167. Diff Min Subcarrier Power to Lower Limit for Offset F Positive Side</b> – a floating point number in dB. If Offset F is off and Offset Side is POS, this returns -999.0.
	<b>168. Diff Min Subcarrier Power Index for Offset F Positive Side</b> – an integer number. If Offset F is off, this returns -999.0.

## Modulation Analysis Measurement Description

The measurement provides a full set of demodulation properties that support OFDMA scalable parameters including data tone modulation, frame length, nominal bandwidth, BW ratio, guard interval, and FFT size. This measurement covers the following metrics:

- IQ Meas constellation measurement data (includes multiple formats when present)
- Auto detected format: BPSK, QPSK, 16QAM, 64QAM (color coded for display)
- Subchannelization supported
- RCE vs. Time and Frequency
- Preamble Frequency err (used to show frequency settling)
- Data burst information (modulation format, size and burst power)

This measurement takes into account all possible error mechanisms in the entire transmission chain including: baseband filtering, I/Q modulation anomalies, filter amplitude and phase non-linearities, and power amplifier distortions.

Key Path	Meas
Initial S/W Revision	Prior to A.02.00
Modified at S/W Revision	A.02.00

## AMPTD Y Scale

The AMPTD Y Scale key accesses the menus that enable you to set the desired vertical scale and associated settings. The settings available vary depending on the active window focus.

Key Path	Front-Panel
Initial S/W Revision	Prior to A.02.00

### Range

The Range menu allows setting amplitude controls of the instrument.

Key Path	AMPTD Y Scale
Scope	Meas Global
Initial S/W Revision	A.12.50

### Range

Represents the amplitude of the largest sinusoidal signal that could be present within the IF without being clipped by the ADC. For signals with high peak-to-average ratios, the range may need to exceed the rms signal power by a fair amount to avoid clipping.

Key Path	Range
Mode	BASIC
<b>Remote Command</b>	<code>[ :SENSe ] :POWer [ :RF ] :RANGe &lt;real&gt;</code> <code>[ :SENSe ] :POWer [ :RF ] :RANGe?</code>
<b>Example</b>	<code>:POW:RANG 10.0</code> <code>:POW:RANG?</code>
Notes	The MIN and MAX values are affected by the External Gain parameters, and by the Center Frequency. (The hardware compensates for frequency response and alters the Range setting.)
Preset	0
State Saved	Saved in instrument state.
Min	-100
Max	100
Initial S/W Revision	A.12.50

### Adjust Range For Min Clip

Sets the combination of attenuation and gain based on the current measured signal level so that clipping will be at a minimum.

This is an "immediate action" function, that is, it executes once, when the key is pressed.

This key is grayed out in measurements that do not support this functionality.

Key Path	AMPTD Y Scale, Attenuation
Remote Command	<code>[ :SENSe ] :POWer [ :RF ] :RANGe:OPTimize IMMEDIATE</code>
Initial S/W Revision	Prior to A.02.00
Modified at S/W Revision	A.03.00

## Pre-Adjust for Min Clip

If this function is on, it does the adjustment described under Adjust Range For Min Clip each time a measurement restarts. Therefore, in Continuous measurement mode, it only executes before the first measurement.

Key Path	AMPTD Y Scale, Attenuation
Remote Command	<code>[ :SENSe ] :POWer [ :RF ] :RANGe:OPTimize:ATTenuation OFF   ON   ELEctrical   COMBined</code>  <code>[ :SENSe ] :POWer [ :RF ] :RANGe:OPTimize:ATTenuation?</code>
Notes	This parameter is shared with old XA platform which uses AutoAtten. To keep the backward compatibility, ELEctrical and COMBined still can be used. Then, upon receiving ELEctrical and COMBined, these enums will be interpreted as aliases of ON. Then, when queried, ON will be returned.
Preset	OFF for Swept SA measurement; ON for all other measurements that support Pre-Adjust for Min Clip
State Saved	Saved in instrument state
Initial S/W Revision	Prior to A.02.00
Modified at S/W Revision	A.03.00

## Peak to Average

The Peak to Average Ratio is used with the Range setting to optimize the level control in the instrument. The value is the ratio, in dB, of the peak power to the average power of the signal to be measured. A ratio of 0 should be used for sinusoidal signals; for 802.11g OFDM signals use 9 dB.

All Applications (Modes) will show the current value of Peak to Average ratio on the softkey. However, some applications will not permit changing the value. In these situations the softkey will be grayed-out.

Key Path	AMPTD Y Scale, Range
Remote Command	<code>[ :SENSe ] :POWer [ :RF ] :RANGe:PARatio &lt;real&gt;</code>  <code>[ :SENSe ] :POWer [ :RF ] :RANGe:PARatio?</code>
Example	POW:RANG:PAR 12 dB
Notes	In some Applications (Modes) this parameter will be read-only; meaning the value will appear on the softkey and query via SCPI, but not changeable. In such applications the softkey will be grayed-out. Attempting to change the value via SCPI will be ignored and no error message will be generated.



Preset	10 dB
State Saved	Saved in instrument state
Min	0 dB
Max	20 dB
Initial S/W Revision	A.13.00

### Mixer Level Offset

Mixer level offset is an advanced setting to adjust target Range at the input mixer which in turn affects the signal level in the instrument's IF. This setting can be used when additional optimization is needed after setting Peak to Average ratio. Positive values of offset optimize noise performance over distortion, negative values optimize distortion performance over noise.

Key Path	AMPTD Y Scale, Range
<b>Remote Command</b>	[ :SENSe ] :POWer [ :RF ] :RANGe :MIXer :OFFSet <real> [ :SENSe ] :POWer [ :RF ] :RANGe :MIXer :OFFSet?
<b>Example</b>	POW:RANG:MIX:OFFS -5 dB
Preset	0 dB
State Saved	Saved in instrument state
Min	-35 dB
Max	30 dB
Initial S/W Revision	A.13.00

## Auto Couple

The Auto Couple feature provides a quick and convenient way to automatically couple multiple instrument settings. This helps ensure accurate measurements and optimum dynamic range. When the Auto Couple feature is activated, either from the front panel or remotely, all parameters of the current measurement that have an Auto/Manual mode are set to Auto mode and all measurement settings dependent on (or coupled to) the Auto/Man parameters are automatically adjusted for optimal performance.

However, the Auto Couple key actions are confined to the current measurement only. It does not affect other measurements in the mode, and it does not affect markers, marker functions, or trace or display attributes.

See ["More Information" on page 1246](#)

<b>Key Path</b>	Front-panel key
<b>Remote Command</b>	:COUPLe ALL NONE
<b>Example</b>	:COUP ALL
<b>Notes</b>	:COUPLe ALL puts all Auto/Man parameters in Auto mode (equivalent to pressing the Auto Couple key). :COUPLE NONE puts all Auto/Man parameters in manual mode. It decouples all the coupled instrument parameters and is not recommended for making measurements.
<b>Initial S/W Revision</b>	Prior to A.02.00

### More Information

There are two types of functions that have Auto/Manual modes.

#### Auto/Man Active Function keys

An Auto/Man toggle key controls the binary state associated with an instrument parameter by toggling between Auto (where the parameter is automatically coupled to the other parameters it is dependent upon) and Man (where the parameter is controlled independent of the other parameters), as well as making the parameter the active function. The current mode is indicated on the softkey with either Auto or Man underlined as illustrated below.

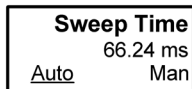

vsd07

#### Auto/Man 1-of-N keys

An Auto/Man 1-of-N key allows you to manually pick from a list of parameter values, or place the function in Auto, in which case the value is automatically selected (and indicated) as shown below. If in Auto, Auto is underlined on the calling key. If in manual operation, manual is indicated on the calling key. But the calling key does not actually toggle the function, it simply opens the menu.

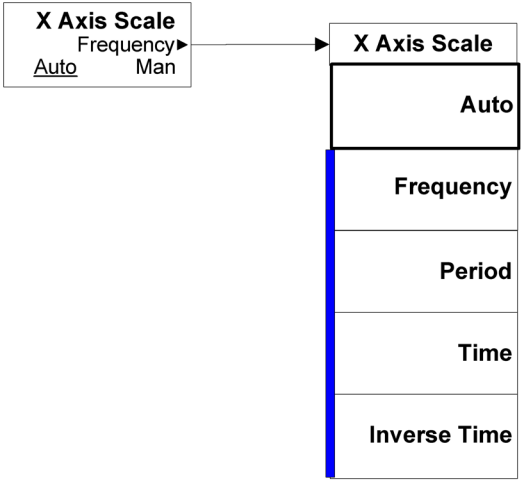

vsd08

## BW

Accesses parameters that affect bandwidth.

Key Path	BW
Initial S/W Revision	Prior to A.02.00

### Info BW

Activates the Info BW active function, which enables you to manually set the information bandwidth (Info BW) of the analyzer.

Key Path	BW
Mode	WIMAXOFDMA
<b>Remote Command</b>	<code>[ :SENSe ] :EVM: BANDwidth [ :RESolution ] &lt;bandwidth&gt;</code> <code>[ :SENSe ] :EVM: BANDwidth [ :RESolution ] ?</code>
<b>Example</b>	EVM:BAND 10e6 EVM:BAND?
Preset	10 MHz
State Saved	Saved in instrument state.
Min	1 MHz
Max	Hardware Dependent: RF Input: No Option = 10 MHz Option B25 = 25 MHz WB (40 MHz or wider) = 40 MHz I/Q Input (for I+jQ): No Option = 20 MHz Option B25 or S40 = 40 MHz
<b>Backwards Compatibility SCPI</b>	<code>[ :SENSe ] :EVM: BWIDth [ :RESolution ]</code>
Initial S/W Revision	Prior to A.02.00
Modified at S/W Revision	A.02.00, A.06.00

## Cont (Continuous Measurement/Sweep)

Sets the analyzer for Continuous measurement operation. The single/continuous state is Meas Global so the setting will affect all measurements. If you are Paused, pressing Cont does a Resume.

Key Path	Front-panel key
Remote Command	:INITiate:CONTinuous OFF ON 0 1 :INITiate:CONTinuous?
Example	:INIT:CONT 0 puts analyzer in Single measurement operation. :INIT:CONT 1 puts analyzer in Continuous measurement operation
Preset	ON (Note that SYST:PRESet sets INIT:CONT to ON but *RST sets INIT:CONT to OFF)
State Saved	Saved in instrument state
Backwards Compatibility Notes	For Spectrum Analysis mode in ESA and PSA, there is no Cont hardkey, instead there is a Sweep Single/Cont key. In these analyzers, switching the Sweep Single/Cont key from Single to Cont restarts averages (displayed average count reset to 1), but does not restart Max Hold and Min Hold. The X-Series has Single and Cont keys in place of the SweepSingleCont key. In the X-Series, if in single measurement, the Cont key (and INIT:CONT ON ) switches to continuous measurement, but never restarts a measurement and never resets a sweep.
Initial S/W Revision	Prior to A.02.00

In Swept SA Measurement (Spectrum Analysis Mode):

The analyzer takes repetitive sweeps, averages, measurements, etc., when in Continuous mode. When the average count reaches the Average/Hold Number the count stops incrementing, but the analyzer keeps sweeping. See the Trace/Detector section for the averaging formula used both before and after the Average/Hold Number is reached. The trigger condition must be met prior to each sweep. The type of trace processing for multiple sweeps, is set under the Trace/Detector key, with choices of Trace Average, Max Hold, or Min Hold.

In Other Measurements/Modes:

With Avg/Hold Num (in the Meas Setup menu) set to Off or set to On with a value of 1, a sweep is taken after the trigger condition is met; and the analyzer continues to take new sweeps after the current sweep has completed and the trigger condition is again met. However, with Avg/Hold Num set to On with a value >1, multiple sweeps (data acquisitions) are taken for the measurement. The trigger condition must be met prior to each sweep. The sweep is not stopped when the average count k equals the number N set for Avg/Hold Num is reached, but the number k stops incrementing. A measurement average usually applies to all traces, marker results, and numeric results. But sometimes it only applies to the numeric results.

If the analyzer is in Single measurement, pressing the Cont key does not change k and does not cause the sweep to be reset; the only action is to put the analyzer into Continuous measurement operation.

If it is already in continuous sweep:

the INIT:CONT 1 command has no effect

## 11 Modulation Analysis Measurement Cont (Continuous Measurement/Sweep)

the INIT:CONT 0 command will place the analyzer in Single Sweep but will have no effect on the current sequence until  $k = N$ , at which point the current sequence will stop and the instrument will go to the idle state.

File

See "File" on page 178

## FREQ Channel

Accesses a menu of keys that allow you to control the Frequency and Channel parameters of the instrument.

Some features in the Frequency menu are the same for all measurements – they do not change as you change measurements. Settings like these are called “Meas Global” and are unaffected by Meas Preset. For example, the Center Freq setting is the same for all measurements - it does not change as you change measurements.

<b>Key Path</b>	<b>Front-panel key</b>
Initial S/W Revision	Prior to A.02.00

### Center Freq

Sets the frequency that corresponds to the horizontal center of the graticule (when frequency Scale Type is set to linear). While adjusting the Center Frequency the Span is held constant, which means that both Start Frequency and Stop Frequency will change.

Pressing Center Freq also sets the frequency entry mode to Center/Span. In Center/Span mode, the center frequency and span values are displayed below the graticule, and the default active function in the Frequency menu is Center Freq.

The center frequency setting is the same for all measurements within a mode, that is, it is Meas Global. Some modes are also able to share a Mode Global center frequency value. If this is the case, the Mode will have a Global Settings key in its Mode Setup menu.

The Center Freq function sets (and queries) the Center Frequency for the currently selected input. If your analyzer has multiple inputs, and you select another input, the Center Freq changes to the value for that input. SCPI commands are available to directly set the Center Freq for a specific input.

Center Freq is remembered as you go from input to input. Thus you can set a Center Freq of 10 GHz with the RF Input selected, change to BBIQ and set a Center Freq of 20 MHz, then switch to External Mixing and set a Center Freq of 60 GHz, and when you go back to the RF Input the Center Freq will go back to 10 GHz; back to BBIQ and it is 20 MHz; back to External Mixing and it is 60 GHz.

See ["RF Center Freq" on page 1255](#)

See [Ext Mix Center Freq](#)

See ["I/Q Center Freq" on page 1257](#)

See ["Center Frequency Presets" on page 1253](#)

<b>Key Path</b>	<b>FREQ Channel</b>
<b>Scope</b>	<b>Meas Global</b>
<b>Remote Command</b>	<code>[ :SENSe ] :FREQuency:CENTer &lt;freq&gt;</code> <code>[ :SENSe ] :FREQuency:CENTer?</code>
<b>Example</b>	<code>FREQ:CENT 50 MHz</code>



	FREQ:CENT UP changes the center frequency to 150 MHz if you use FREQ:CENT:STEP 100 MHz to set the center frequency step size to 100 MHz FREQ:CENT?
Notes	This command sets either the RF or I/Q Center Frequency depending on the selected input. For RF input it is equivalent to FREQ:RF:CENT For I/Q input it is equivalent to FREQ:IQ:CENT Preset and Max values are dependent on Hardware Options (5xx) If no terminator (e.g. MHz) is sent the terminator Hz is used. If a terminator with unit other than Frequency is used, an invalid suffix error message is generated.
Dependencies	The Center Frequency can be limited by Start or Stop Freq limits, if the Span is so large that Start or Stop reach their limit.
Couplings	When operating in "swept span", any value of the Center Frequency or Span that is within the frequency range of the analyzer is allowed when the value is being set through the front panel numeric key pad or the SCPI command. The other parameter is forced to a different value if needed, to keep the Start and the Stop Frequencies within the analyzer's frequency range
Preset	Depends on instrument maximum frequency, mode, measurement, and selected input. See "Center Frequency Presets" on page 1253 and "RF Center Freq" on page 1255 and Ext Mix Center Freq and "I/Q Center Freq" on page 1257.
State Saved	Saved in instrument state
Min	Depends on instrument maximum frequency, mode, measurement, and selected input.. See "Center Frequency Presets" on page 1253 and "RF Center Freq" on page 1255 and "I/Q Center Freq" on page 1257.
Max	Depends on instrument maximum frequency, mode, measurement, and selected input.. See "Center Frequency Presets" on page 1253 and "RF Center Freq" on page 1255 and "I/Q Center Freq" on page 1257.
Default Unit	Hz
Status Bits/OPC	Non-overlapped
Dependencies	
Initial S/W Revision	Prior to A.02.00

## Center Frequency Presets

The following table provides the Center Frequency Presets for the Spectrum Analyzer mode, and the Max Freq, for the various frequency options:

Freq Option	CF after Mode Preset	Stop Freq after Mode Preset	Max Freq (can't tune above)

11 Modulation Analysis Measurement  
FREQ Channel

503 (all but N9000A)	1.805 GHz	3.6 GHz	3.7 GHz
503 (N9000A)	1.505 GHz	3.0 GHz	3.08 GHz
504 (M9420A)	1 GHz	3.8GHz	3.88 GHz
506 (M9420A)	1 GHz	6.0GHz	6.08 GHz
507 (all but N9000A)	3.505 GHz	7.0 GHz	7.1 GHz
507 (N9000A)	3.755 GHz	7.5 GHz	7.58 GHz
508 (all but N9038A)	1.805 GHz	3.6 GHz	8.5 GHz
508 (N9038A)	4.205 GHz	8.4 GHz	8.5 GHz
513	6.805 GHz	13.6 GHz	13.8 GHz
526 (all but N9000A and N9038A)	13.255 GHz	26.5 GHz	27.0 GHz
526 (N9000A)	13.255 GHz	26.5 GHz	26.55 GHz
526 (N9038A)	1.805 GHz	3.6 GHz	27.0 GHz
532	16.005 GHz	32.0 GHz	32.5 GHz
543	21.505 GHz	43.0 GHz	TBD
544	22.005 GHz	44.0 GHz	44.5 GHz
550	25.005 GHz	50.0 GHz	51 GHz

Input 2:

Model	CF after Mode Preset	Stop Freq after Mode Preset	Max Freq (can't tune above)
N9000A opt C75	0.7505GHz	1.5 GHz	1.58 GHz
N9038A	505 MHz	1 GHz	1.000025 GHz

Tracking Generator Frequency Limits (N9000A only):

Tracking Generator Option	Min Freq (clips to this freq when turn TG on and can't tune below while TG on)	If above this Freq, Stop Freq clipped to this Freq when TG turned on	Max Freq (can't tune above) while TG on
T03	9 kHz	3.0 GHz	3.08 GHz
T06	9 kHz	6.0 GHz	6.05 GHz

The following table shows the Center Frequency Presets for modes other than Spectrum Analyzer:

Mode	CF Preset for RF
WCDMA	1 GHz
WIMAXOFDMA,	1 GHz
BASIC	1 GHz
ADEMOD	1 GHz
VSA	1 GHz
TDSCDMA	1 GHz
PNOISE	1 GHz
LTE	1 GHz
LTETDD	1 GHz
MSR	1 GHz
GSM	935.2 MHz
NFIGURE	1.505 GHz

## RF Center Freq

SCPI command for specifying the RF Center Frequency. This command will set the Center Frequency to be used when the RF input is selected, even if the RF input is not the input that is selected at the time the command is sent. Note that the Center Freq function in the Frequency menu on the front panel always applies to the currently selected input.

Scope	Meas Global
<b>Remote Command</b>	<code>[ :SENSe ] :FREQuency:RF:CENTer &lt;freq&gt;</code> <code>[ :SENSe ] :FREQuency:RF:CENTer?</code>
<b>Example</b>	FREQ:RF:CENT 30 MHz
Notes	This command is the same in all modes, but the parameter is Measurement Global. So the value is independent in each mode and common across all the measurements in the mode.
Dependencies	If the electronic/soft attenuator is enabled, any attempt to set Center Frequency such that the Stop Frequency would be >3.6 GHz fails and results in an advisory message. If the equivalent SCPI

	command is sent, this same message is generated as part of a “-221, Settings conflict” warning. If Source Mode is set to Tracking, and the Max or Min Center Freq is therefore limited by the limits of the source, a warning message is generated, “Data out of range;clipped to source max/min” if these limits are exceeded. Note that for an external source, these limits can be affected by the settings of Source Numerator, Source Denominator and Power Sweep.
Preset	See table above
State Saved	Saved in instrument state.
Min	-79.999995 MHz, unless Source Mode is set to Tracking, in which case it is limited by the minimum frequency of the Source
Max	See table above. Basically instrument maximum frequency – 5 Hz. Note that, if the Source Mode is set to Tracking, the effective instrument maximum frequency may be limited by the source maximum frequency. If the knob or step keys are being used, also depends on the value of the other three interdependent parameters Span, Start Frequency and Stop Frequency
Initial S/W Revision	Prior to A.02.00
Modified at S/W Revision	A.03.00

### Ext Mix Center Freq

SCPI command for specifying the External Mixer Center Frequency. This command will set the Center Frequency to be used when the External Mixer is selected, even if the External Mixer input is not the input which is selected at the time the command is sent. Note that the Center Freq function in the Frequency menu on the front panel always applies to the currently selected input.

Scope	Meas Global
<b>Remote Command</b>	<code>[ :SENSE ] :FREQuency:EMIXer:CENTer &lt;freq&gt;</code> <code>[ :SENSE ] :FREQuency:EMIXer:CENTer?</code>
<b>Example</b>	<code>:FREQ:EMIX:CENT 60 GHz</code> <code>:FREQ:EMIX:CENT?</code>
Notes	This command is the same in all modes, but the parameter is Measurement Global. So the value is independent in each mode and common across all the measurements in the mode.
Couplings	When returning to External Mixing after having been switched to one of the other inputs (e.g., RF), you will come back into the settings that you had when you left External Mixing. So you will come back to the band you were in with the Center Frequency that you had. However, Span is not an input-dependent parameter, therefore you will bring the span over from the other input. Therefore, the analyzer comes back with the span from the previous input, limited as necessary by the current mixer setup.
Preset	When a Mode Preset is performed while in External Mixing, the Start frequency of the current Mode is set to the nominal Min Freq of the lowest harmonic range in the Harmonic Table for the current mixer setup. Similarly, the Stop frequency of the current Mode is set to the nominal Max Freq of the highest harmonic range in the Harmonic Table. The Center Freq thus presets to the point arithmetically equidistant from these two frequencies.

If the current measurement has a limited Span available to it, and cannot achieve the Span shown in the table (Span=Stop Freq - Start Freq), the analyzer uses the maximum Span the measurement allows, and still sets the Center Freq to the midpoint of the Start and Stop Freq values in the Harmonic Table.

When Restore Input/Output Defaults is performed, the mixer presets to the 11970A, whose Start and Stop frequencies are 26.5 and 40 GHz respectively. The center of these two frequencies is 33.25 GHz.

Therefore, after a Restore Input/Output Defaults, if you go into External Mixing and do a Mode Preset while in the Spectrum Analyzer Mode, the resulting Center Freq is 33.25 GHz.

State Saved	Saved in instrument state.
Min	The minimum frequency in the currently selected mixer band + 5 Hz
Max	The maximum frequency in the currently selected mixer band - 5 Hz If the knob or step keys are being used, also depends on the value of the other three interdependent parameters Span, Start Frequency and Stop Frequency
Initial S/W Revision	A.08.01

## I/Q Center Freq

SCPI command for specifying the I/Q Center Frequency. This command will set the Center Frequency to be used when the I/Q input is selected, even if the I/Q input is not the input which is selected at the time the command is sent. Note that the Center Freq function in the Frequency menu on the front panel always applies to the currently selected input.

Scope	Meas Global
<b>Remote Command</b>	[ :SENSe ] :FREQuency:IQ:CENTer <freq> [ :SENSe ] :FREQuency:IQ:CENTer?
<b>Example</b>	FREQ:IQ:CEN: 30 MHz
Notes	This command is the same in all modes, but the parameter is Measurement Global. So the value is independent in each mode and common across all the measurements in the mode.
Preset	0 Hz
State Saved	Saved in instrument state.
Min	-40.049995 MHz
Max	40.049995 MHz
Initial S/W Revision	Prior to A.02.00

## Input/Output

See "[Input/Output](#)" on page 118

## Marker

Accesses the menu that enables you to select, set up, and control the markers.

Key Path	Marker
Initial S/W Revision	Prior to A.02.00

### Select Marker

Displays 12 markers available for selection.

Key Path	Marker
Initial S/W Revision	Prior to A.02.00

### Marker Type

Sets the marker control mode as described under Normal, Delta and Off, below. All interactions and dependencies detailed under the key description are enforced when the remote command is sent.

Key Path	Marker
Mode	WIMAXOFDMA
<b>Remote Command</b>	:CALCulate:EVM:MARKer[1] 2 ...12:MODE POSition DELTA OFF :CALCulate:EVM:MARKer[1] 2 ...12:MODE?
<b>Example</b>	CALC:EVM:MARK:MODE POS CALC:EVM:MARK:MODE?
Notes	If the selected marker is Off, pressing Marker sets it to Normal and places it at the center of the screen on the trace determined by the Marker Trace rules. At the same time, Marker X Axis Value appears on the Active Function area. Default Active Function: The active function for the selected marker's current control mode. If the current control mode is Off, there is no active function, and the active function is set to Off. Active Function Display: - the marker Chip value in the IQ Measured Polar graph - the marker X axis value in any other graph The value entered in the active function area will display the marker value to its full entered precision.
Preset	OFF
State Saved	Saved in instrument state.
Range	Normal Delta Off
Initial S/W Revision	Prior to A.02.00

## Properties

Accesses a menu that enables you to set marker properties and to access the marker trace menu.

Key Path	Marker
Initial S/W Revision	Prior to A.02.00

## Select Marker

Displays 12 markers available for selection.

Key Path	Marker
Initial S/W Revision	Prior to A.02.00

## Relative To

Selects the marker that the selected marker will be relative to - its reference marker.

Key Path	Marker, Properties
Mode	WIMAXOFDMA
<b>Remote Command</b>	:CALCulate:EVM:MARKer[1] 2 ...12:REFerence <integer> :CALCulate:EVM:MARKer[1] 2 ...12:REFerence?
<b>Example</b>	CALC:EVM:MARK:REF 2 CALC:EVM:MARK:REF?
Notes	A marker cannot be relative to itself so that choice is grayed out, and if sent from SCPI generates error -221: "Settings conflict; marker cannot be relative to itself." When queried a single value will be returned (the specified marker numbers relative marker).
Preset	2 3 4 5 6 7 8 9 10 11 12 1
State Saved	Saved in instrument state.
Min	1
Max	12
Initial S/W Revision	Prior to A.02.00

## Marker Trace

Accesses a menu that enables you to assign a specified marker to the designated trace.

Symbol Traces means that three traces for I/Q polar, Symbol Error Carrier, Symbol Error Symbol, Symbol Power Carrier, and Symbol Power Symbol can be assigned. If used, a marker pointer is placed on each trace. In this case, the three pointers will move at the same time, as coupled markers, whenever the X position of the Symbol Traces changes.



Key Path	Marker
Mode	WIMAXOFDMA
<b>Remote Command</b>	:CALCulate:EVM:MARKer[1] 2 ...12:TRACe SYMBol   POLar   EVCarrier   RECarrier   EVSymbol   RESymbol   PCARrier   RPCarrier   PSYMBOL   RPSymbol   FLATness   DFLatness   PVT   SPECTrum :CALCulate:EVM:MARKer[1] 2 ...12:TRACe?
<b>Example</b>	CALC:EVM:MARK:TRAC SYMB CALC:EVM:MARK:TRAC?
Preset	SYMB
State Saved	Saved in instrument state.
Range	Symbol Traces IQ Measured Polar ConstIn Error Vector Carrier RMS Error Vector Carrier Error Vector Symbol RMS Error Vector Symbol Symbol Power Carrier RMS Symbol Power Carrier Symbol Power Symbol RMS Symbol Power Symbol PvT Spectrum
Initial S/W Revision	Prior to A.02.00

## All Markers Off

Turns all markers off.

Key Path	Marker, More
Mode	WIMAXOFDMA
<b>Remote Command</b>	:CALCulate:EVM:MARKer:AOFF
<b>Example</b>	CALC:EVM:MARK:AOFF
Initial S/W Revision	Prior to A.02.00

## Marker X Axis Value (Remote Command only)

Sets the marker X Axis value in the current marker X Axis Scale unit. It has no effect if the control mode is Off, but is the SCPI equivalent of entering an X value if the control mode is Normal or Delta.

Mode	WIMAXOFDMA
<b>Remote Command</b>	:CALCulate:EVM:MARKer[1] 2 ...12:X <real> :CALCulate:EVM:MARKer[1] 2 ...12:X?
<b>Example</b>	CALC:EVM:MARK3:X 0 CALC:EVM:MARK3:X?
Notes	If no suffix is sent, it will use the fundamental units for the current marker X Axis Scale. If a suffix is sent that does not match the current marker X Axis Scale unit, an "Invalid suffix" error will be generated.  The query returns the marker's absolute X Axis value if the control mode is Normal, or the offset from the marker's reference marker if the control mode is Delta. The query is returned in the fundamental units for the current marker X Axis scale: Hz for Frequency and Inverse Time, seconds for Period and

	Time. If the marker is Off the response is not a number (NAN).
Preset	After a preset, all markers are set to Off, so a Marker X Axis Value query will return a not a number (NAN).
State Saved	No
Min	-9.9E+37
Max	9.9E+37.
Initial S/W Revision	Prior to A.02.00

### Marker X Axis Position (Remote Command only)

Sets the marker X position in trace points. It has no effect if the control mode is Off, but is the SCPI equivalent of entering a value if the control mode is Normal or Delta - except in trace points rather than X Axis Scale units. The entered value is immediately translated into the current X Axis Scale units for setting the value of the marker.

Mode	WIMAXOFDMA
<b>Remote Command</b>	:CALCulate:EVM:MARKer[1] 2 ...12:X:POSition <real> :CALCulate:EVM:MARKer[1] 2 ...12:X:POSition?
<b>Example</b>	CALC:EVM:MARK10:X:POS 10 CALC:EVM:MARK10:X:POS?
Notes	The query returns the marker's absolute X Axis value in trace points if the control mode is Normal, or the offset from the marker's reference marker in trace points, if the control mode is Delta. The value is returned as a real number, not an integer, corresponding to the translation from X Axis Scale units to trace points (see "Fractional Trace Points", above). If the marker is Off the response is not a number(NAN).
Preset	After a preset, all markers are set to Off, so Marker X Axis Value query will return a not a number (NAN).
State Saved	No
Min	-9.9E+37
Max	9.9E+37
Initial S/W Revision	Prior to A.02.00

### Marker X Axis Subcarrier (Remote Command only)

Sets the marker X subcarrier in trace points. It has no effect if the control mode is Off, but is the SCPI equivalent of entering a value if the control mode is Normal or Delta - except in trace points rather than X Axis Scale units. The entered value is immediately translated into the current X Axis Scale units for setting the value of the marker.

Mode	WIMAXOFDMA
<b>Remote Command</b>	:CALCulate:EVM:MARKer[1] 2 ...12:X:SUBCarrier <integer>

	:CALCulate:EVM:MARKer[1] 2 ...12:X:SUBCarrier?
<b>Example</b>	CALC:EVM:MARK10:X:SUBC 20 CALC:EVM:MARK10:X:SUBC?
<b>Notes</b>	The query returns the marker's absolute X Axis subcarrier value in trace points if the control mode is Normal, or the offset from the marker's reference marker in trace points, if the control mode is Delta. If the marker is Off the response is not a number(NAN).  This command is not available when Marker Trace of the selected marker (:CALCulate:EVM:MARKer[1] 2 3 4 5 6 7 8 9 10 11 12:TRACe?) is set to PVT or SPECTrum. In this case, this command is ignored.
<b>Preset</b>	After a preset, all markers are set to Off, so Marker X Axis Subcarrier Value query will return a not a number (NAN).
<b>State Saved</b>	No
<b>Min</b>	-2147483648
<b>Max</b>	2147483647
<b>Initial S/W Revision</b>	Prior to A.02.00

### Marker X Axis Symbol (Remote Command only)

Sets the marker X symbol in trace points. It has no effect if the control mode is Off, but is the SCPI equivalent of entering a value if the control mode is Normal or Delta - except in trace points rather than X Axis Scale units. The entered value is immediately translated into the current X Axis Scale units for setting the value of the marker.

<b>Mode</b>	WIMAXOFDMA
<b>Remote Command</b>	:CALCulate:EVM:MARKer[1] 2 ...12:X:SYMBOL <integer> :CALCulate:EVM:MARKer[1] 2 ...12:X:SYMBOL?
<b>Example</b>	CALC:EVM:MARK10:X:SYMB 1 CALC:EVM:MARK10:X:SYMB?
<b>Notes</b>	The query returns the marker's absolute X Axis subcarrier value in trace points if the control mode is Normal, or the offset from the marker's reference marker in trace points, if the control mode is Delta. If the marker is Off the response is not a number(NAN).  This command is not available when Marker Trace of the selected marker (:CALCulate:EVM:MARKer[1] 2 3 4 5 6 7 8 9 10 11 12:TRACe?) is set to RECarrier, RPCarrier, FLATness, DFLatness, PVT or SPECTrum. In this case, this command is ignored.
<b>Preset</b>	After a preset, all markers are set to Off, so Marker X Axis Symbol Value query will return a not a number (NAN).
<b>State Saved</b>	No
<b>Min</b>	-2147483648
<b>Max</b>	2147483647
<b>Initial S/W Revision</b>	Prior to A.02.00

## Marker Y Axis Value (Remote Command only)

Sets the marker Y Axis value in the current marker Y Axis unit.

Mode	WIMAXOFDMA
<b>Remote Command</b>	:CALCulate:EVM:MARKer[1] 2 ...12:Y?
<b>Example</b>	CALC:EVM:MARK11:Y?
Notes	<p>If no suffix is sent it will use the current Y Axis unit. If a suffix is sent that does not have units of absolute amplitude, an "Invalid suffix" error will be generated.</p> <p>The query returns the marker Y-axis result if the control mode is Normal or Delta. If the marker is Off the response is not a number (NAN)</p> <p>Query results depend on the selected Marker Trace as follows:</p> <p>Symbol Traces:I, Q, EVM(%), RCE(dB), Power(dBm)</p> <p>*I/Q Measured Polar:I, Q (In normalized voltage)</p> <p>*Error Vector Carrier:EVM(%), RCE(dB)</p> <p>RMS Error Vector Carrier:EVM(%), RCE(dB)</p> <p>*Error Vector Symbol:EVM(%), RCE(dB)</p> <p>RMS Error Vector Symbol:EVM(%), RCE(dB)</p> <p>*Symbol Power Carrier:dBm</p> <p>RMS Symbol Power Carrier:dBm</p> <p>*Symbol Power Symbol:dBm</p> <p>RMS Symbol Power Symbol:dBm</p> <p>Abs Spectral Flatness:dB</p> <p>Diff Spectral Flatness:dB</p> <p>PvT:dBm</p> <p>Spectrum:dBm</p> <p>Each asterisk(*) indicates Marker Traces that are coupled to Symbol Trace when Symbol Traces is selected.</p>
Preset	Result dependant on Markers setup and signal source
State Saved	No
<b>Backwards Compatibility SCPI</b>	:CALCulate:EVM:MARKer[1] 2 ...12:FUNCTion:RESult?
Initial S/W Revision	Prior to A.02.00

## Backward Compatibility SCPI Commands

Sets or queries the state of a marker. Setting a marker which is Off to On, or 1, puts it in Normal mode and places it at the center of the screen.

Mode	WIMAXOFDMA
<b>Remote Command</b>	:CALCulate:EVM:MARKer[1] 2 ...12:STATe OFF ON 0 1 :CALCulate:EVM:MARKer[1] 2 ...12:STATe?

<b>Example</b>	CALC:EVM:MARK3:STAT ON CALC:EVM:MARK3:STAT?
Preset	OFF
State Saved	Saved in instrument state.
Range	On Off
Initial S/W Revision	Prior to A.02.00

## Marker Function

There are no 'Marker Functions' supported in Mod Analysis so this front-panel key will display a blank softkey when pressed.

---

Key Path	Marker
Initial S/W Revision	Prior to A.02.00

---

## Marker To

There is no 'Marker To' functionality supported in Mod Analysis so this front-panel key will display a blank softkey when pressed.

---

Key Path	Marker
Initial S/W Revision	Prior to A.02.00

---

## Meas

The information in this section is common to all measurements. For key and remote command information for a specific measurement, refer to the section that describes the measurement of interest.

Measurements available under the Meas key are specific to the current Mode.

When viewing Help for measurements, note the following:

**NOTE**

Operation for some keys differs between measurements. The information displayed in Help pertains to the current measurement. To see how a key operates in a different measurement, exit Help (press the Cancel Esc key), select the measurement, then reenter Help (press the Help key) and press that key.

---

Key Path	Front-panel key
Initial S/W Revision	Prior to A.02.00

---

### Remote Measurement Functions

This section contains the following topics:

["Measurement Group of Commands" on page 1269](#)

["Current Measurement Query \(Remote Command Only\)" on page 1271](#)

["Limit Test Current Results \(Remote Command Only\)" on page 1271](#)

["Data Query \(Remote Command Only\)" on page 1271](#)

["Calculate/Compress Trace Data Query \(Remote Command Only\)" on page 1272](#)

["Calculate Peaks of Trace Data \(Remote Command Only\)" on page 1277](#)

["Hardware-Accelerated Fast Power Measurement \(Remote Command Only\)" on page 1278](#)

["Format Data: Numeric Data \(Remote Command Only\)" on page 1292](#)

["Format Data: Byte Order \(Remote Command Only\)" on page 1293](#)

---

Initial S/W Revision	Prior to A.02.00
----------------------	------------------

---



## Measurement Group of Commands

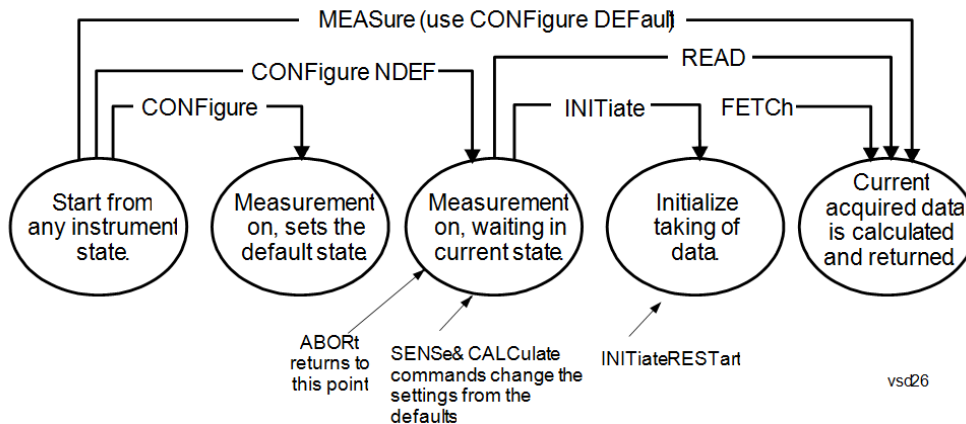

---

### Measure Commands:

:MEASure:<measurement>[n]?

This is a fast single-command way to make a measurement using the factory default instrument settings. These are the settings and units that conform to the Mode Setup settings (e.g. radio standard) that you have currently selected.

- Stops the current measurement (if any) and sets up the instrument for the specified measurement using the factory defaults
- Initiates the data acquisition for the measurement
- Blocks other SCPI communication, waiting until the measurement is complete before returning results.
- If the function does averaging, it is turned on and the number of averages is set to 10.
- After the data is valid it returns the scalar results, or the trace data, for the specified measurement. The type of data returned may be defined by an [n] value that is sent with the command.
- The scalar measurement results will be returned if the optional [n] value is not included, or is set to 1. If the [n] value is set to a value other than 1, the selected trace data results will be returned. See each command for details of what types of scalar results or trace data results are available.
- ASCII is the default format for the data output. (Older versions of Spectrum Analysis and Phase Noise mode measurements only use ASCII.) The binary data formats should be used for handling large blocks of data since they are smaller and faster than the ASCII format. Refer to the FORMat:DATA command for more information.

If you need to change some of the measurement parameters from the factory default settings you can set up the measurement with the CONFIgure command. Use the commands in the SENSe:<measurement> and CALCulate:<measurement> subsystems to change the settings. Then you can use the READ? command to initiate the measurement and query the results.

If you need to repeatedly make a given measurement with settings other than the factory defaults, you can use the commands in the SENSe:<measurement> and CALCulate:<measurement> subsystems to set up the measurement. Then use the READ? command to initiate the measurement and query results.

Measurement settings persist if you initiate a different measurement and then return to a previous one. Use READ:<measurement>? if you want to use those persistent settings. If you want to go back to the default settings, use MEASure:<measurement>?.

---

### Configure Commands:

:CONFIgure:<measurement>

This command stops the current measurement (if any) and sets up the instrument for the specified measurement using

---

---

the factory default instrument settings. It does not initiate the taking of measurement data unless INIT:CONTinuous is ON. If you change any measurement settings after using the CONFigure command, the READ command can be used to initiate a measurement without changing the settings back to their defaults.

In the Swept SA measurement in Spectrum Analyzer mode the CONFigure command also turns the averaging function on and sets the number of averages to 10 for all measurements.

:CONFigure: <measurement>: NDEFault stops the current measurement and changes to the specified measurement. It does not change the settings to the defaults. It does not initiate the taking of measurement data unless INIT:CONTinuous is ON.

The CONFigure? query returns the current measurement name.

The CONFigure:CATalog? query returns a quoted string of all licensed measurement names in the current mode. For example, "SAN, CHP, OBW, ACP, PST, TXP, SPUR, SEM, LIST".

---

#### Fetch Commands:

---

:FETCh:<measurement>[n]?

This command puts selected data from the most recent measurement into the output buffer. Use FETCh if you have already made a good measurement and you want to return several types of data (different [n] values, for example, both scalars and trace data) from a single measurement. FETCh saves you the time of re-making the measurement. You can only FETCh results from the measurement that is currently active, it will not change to a different measurement. An error message is reported if a measurement other than the current one is specified.

If you need to get new measurement data, use the READ command, which is equivalent to an INITiate followed by a FETCh.

The scalar measurement results will be returned if the optional [n] value is not included, or is set to 1. If the [n] value is set to a value other than 1, the selected trace data results will be returned. See each command for details of what types of scalar results or trace data results are available. The binary data formats should be used for handling large blocks of data since they are smaller and transfer faster than the ASCII format. (FORMat:DATA)

FETCh may be used to return results other than those specified with the original READ or MEASure command that you sent.

---

#### INITiate Commands:

---

:INITiate:<measurement>

This command is not available for measurements in all the instrument modes:

- Initiates a trigger cycle for the specified measurement, but does not output any data. You must then use the FETCh<meas> command to return data. If a measurement other than the current one is specified, the instrument will switch to that measurement and then initiate it.
  - For example, suppose you have previously initiated the ACP measurement, but now you are running the channel power measurement. If you send INIT:ACP? it will change from channel power to ACP and will initiate an ACP measurement.
  - Does not change any of the measurement settings. For example, if you have previously started the ACP measurement and you send INIT:ACP? it will initiate a new ACP measurement using the same instrument settings as the last time ACP was run.
  - If your selected measurement is currently active (in the idle state) it triggers the measurement, assuming the trigger conditions are met. Then it completes one trigger cycle. Depending upon the measurement and the number of averages, there may be multiple data acquisitions, with multiple trigger events, for one full trigger cycle. It also holds off additional commands on GPIB until the acquisition is complete.
- 

#### READ Commands:

---

:READ:<measurement>[n]?

- Does not preset the measurement to the factory default settings. For example, if you have previously initiated the ACP
-

---

measurement and you send READ:ACP? it will initiate a new measurement using the same instrument settings.

- Initiates the measurement and puts valid data into the output buffer. If a measurement other than the current one is specified, the instrument will switch to that measurement before it initiates the measurement and returns results.
  - For example, suppose you have previously initiated the ACP measurement, but now you are running the channel power measurement. Then you send READ:ACP? It will change from channel power back to ACP and, using the previous ACP settings, will initiate the measurement and return results.
  - Blocks other SCPI communication, waiting until the measurement is complete before returning the results
  - If the optional [n] value is not included, or is set to 1, the scalar measurement results will be returned. If the [n] value is set to a value other than 1, the selected trace data results will be returned. See each command for details of what types of scalar results or trace data results are available. The binary data formats should be used when handling large blocks of data since they are smaller and faster than the ASCII format. (FORMat:DATA)
- 

---

Initial S/W Revision	Prior to A.02.00
----------------------	------------------

---

### Current Measurement Query (Remote Command Only)

This command returns the name of the measurement that is currently running.

---

<b>Remote Command</b>	:CONFigure?
-----------------------	-------------

<b>Example</b>	CONF?
----------------	-------

Initial S/W Revision	Prior to A.02.00
----------------------	------------------

---

### Limit Test Current Results (Remote Command Only)

Queries the status of the current measurement limit testing. It returns a 0 if the measured results pass when compared with the current limits. It returns a 1 if the measured results fail any limit tests.

---

<b>Remote Command</b>	:CALCulate:CLIMits:FAIL?
-----------------------	--------------------------

<b>Example</b>	CALC:CLIM:FAIL? queries the current measurement to see if it fails the defined limits. Returns a 0 or 1: 0 it passes, 1 it fails.
----------------	--------------------------------------------------------------------------------------------------------------------------------------

Initial S/W Revision	Prior to A.02.00
----------------------	------------------

---

### Data Query (Remote Command Only)

Returns the designated measurement data for the currently selected measurement and subopcode.

n = any valid subopcode for the current measurement. See the measurement command results table for your current measurement, for information about what data is returned for the subopcodes.

This command uses the data setting specified by the FORMat:BORDER and FORMat:DATA commands and can return real or ASCII data. (See the format command descriptions under Input/Output in the Analyzer Setup section.)

<b>Remote Command</b>	:CALCulate:DATA[n]?
<b>Notes</b>	The return trace depends on the measurement. In CALCulate:<meas>:DATA[n], n is any valid subopcode for the current measurement. It returns the same data as the FETCH:<measurement>? query where <measurement> is the current measurement.
<b>Initial S/W Revision</b>	Prior to A.02.00

### Calculate/Compress Trace Data Query (Remote Command Only)

Returns compressed data for the currently selected measurement and sub-opcode [n].

n = any valid sub-opcode for that measurement. See the MEASure:<measurement>? command description of your specific measurement for information on the data that can be returned.

The data is returned in the current Y Axis Unit of the analyzer. The command is used with a sub-opcode <n> (default=1) to specify the trace. With trace queries, it is best if the analyzer is not sweeping during the query. Therefore, it is generally advisable to be in Single Sweep, or Update=Off.

This command is used to compress or decimate a long trace to extract and return only the desired data. A typical example would be to acquire N frames of GSM data and return the mean power of the first burst in each frame. The command can also be used to identify the best curve fit for the data.

<b>Remote Command</b>	:CALCulate:DATA<n>:COMPRESS? BLOCK   CFIT   MAXimum   MINimum   MEAN   DMEan   RMS   RMSCubed   SAMPLE   SDEVIation   PPHase [,<soffset> [,<length>[,<roffset>[,<rlimit>]]]]
<b>Example</b>	To query the mean power of a set of GSM bursts: Supply a signal that is a set of GSM bursts. Select the IQ Waveform measurement (in IQ Analyzer Mode). Set the sweep time to acquire at least one burst. Set the triggers such that acquisition happens at a known position relative to a burst. Then query the mean burst levels using, CALC:DATA2:COMP? MEAN, 24e-6, 526e-6 (These parameter values correspond to GSM signals, where 526e-6 is the length of the burst in the slot and you just want 1 burst.)
<b>Notes</b>	The command supports 5 parameters. Note that the last 4 (<soffset>, <length>, <roffset>, <rlimit>) are optional. But these optional parameters must be entered in the specified order. For example, if you want to specify <length>, then you must also specify <soffset>. See details below for a definition of each of these parameters.  This command uses the data in the format specified by FORMat:DATA, returning either binary or ASCII data.
<b>Initial S/W Revision</b>	Prior to A.02.00

- BLOCK or block data - returns all the data points from the region of the trace data that you specify. For example, it could be used to return the data points of an input signal over several timeslots, excluding the portions of the trace data that you do not want. (This is x,y pairs for trace data and I,Q pairs for complex data.)

- CFIT or curve fit - applies curve fitting routines to the data. <soffset> and <length> are required to define the data that you want. <roffset> is an optional parameter for the desired order of the curve equation. The query will return the following values: the x-offset (in seconds) and the curve coefficients ((order + 1) values).

MIN, MAX, MEAN, DME, RMS, RMSC, SAMP, SDEV and PPH return one data value for each specified region (or <length>) of trace data, for as many regions as possible until you run out of trace data (using <roffset> to specify regions). Or they return the number of regions you specify (using <rlimit>) ignoring any data beyond that.

- MINimum - returns the minimum data point (y value) for the specified region(s) of trace data. For I/Q trace data, the minimum magnitude of the I/Q pairs is returned.
- MAXimum - returns the maximum data point (y value) for the specified region(s) of trace data. For I/Q trace data, the maximum magnitude of the I/Q pairs is returned.
- MEAN - returns a single value that is the arithmetic mean of the data point values (in dB/ dBm) for the specified region(s) of trace data. For I/Q trace data, the mean of the magnitudes of the I/Q pairs is returned. See the following equations.

- 

**NOTE**

If the original trace data is in dB, this function returns the arithmetic mean of those log values, not log of the mean power which is a more useful value. The mean of the log is the better measurement technique when measuring CW signals in the presence of noise. The mean of the power, expressed in dB, is useful in power measurements such as Channel Power. To achieve the mean of the power, use the RMS option.

Equation 1

Mean Value of Data Points for Specified Region(s)

$$\text{MEAN} = \frac{1}{n} \sum_{X_i \in \text{region}(s)} X_i$$

where  $X_i$  is a data point value, and  $n$  is the number of data points in the specified region(s).

Equation 2

Mean Value of I/Q Data Pairs for Specified Region(s)

$$\text{MEAN} = \frac{1}{n} \sum_{X_i \in \text{region}(s)} |X_i|$$

where  $|X_i|$  is the magnitude of an I/Q pair, and  $n$  is the number of I/Q pairs in the specified region(s).

- DMEan - returns a single value that is the mean power (in dB/ dBm) of the data point values for the specified region(s) of trace data. See the following equation:

Equation 3

DMEan Value of Data Points for Specified Region(s)

$$\text{DME} = 10 \times \log_{10} \left( \frac{1}{n} \sum_{X_i \in \text{region}(s)} 10^{\frac{X_i}{10}} \right)$$

- RMS - returns a single value that is the average power on a root-mean-squared voltage scale (arithmetic rms) of the data point values for the specified region(s) of trace data. See the following equation.

**NOTE**

For I/Q trace data, the rms of the magnitudes of the I/Q pairs is returned. See the following equation. This function is very useful for I/Q trace data. However, if the original trace data is in dB, this function returns the rms of the log values which is not usually needed.

Equation 4

RMS Value of Data Points for Specified Region(s)

$$\text{RMS} = \sqrt{\frac{1}{n} \sum_{X_i \in \text{region}(s)} X_i^2}$$

where  $X_i$  is a data point value, and  $n$  is the number of data points in the specified region(s).

Equation 5

RMS Value of I/Q Data Pairs for Specified Region(s)

$$\text{RMS} = \sqrt{\frac{1}{n} \sum_{X_i \in \text{region}(s)} X_i X_i^*}$$

where  $X_i$  is the complex value representation of an I/Q pair,  $X_i^*$  its conjugate complex number, and  $n$  is the number of I/Q pairs in the specified region(s).

Once you have the rms value for a region of trace data (linear or I/Q), you may want to calculate the mean power. You must convert this rms value (peak volts) to power in dBm:

$$10 \times \log[10 \times (\text{rms value})^2]$$

- SAMPlE - returns the first data value (x,y pair) for the specified region(s) of trace data. For I/Q trace data, the first I/Q pair is returned.
- SDEViation - returns a single value that is the arithmetic standard deviation for the data point values for the specified region(s) of trace data. See the following equation.
- For I/Q trace data, the standard deviation of the magnitudes of the I/Q pairs is returned. See the following equation.

Equation 6

Standard Deviation of Data Point Values for Specified Region(s)

$$\text{SDEV} = \sqrt{\frac{1}{n} \sum_{X_i \in \text{region}(s)} (X_i - \bar{X})^2}$$

where  $X_i$  is a data point value,  $\bar{X}$  is the arithmetic mean of the data point values for the specified region (s), and  $n$  is the number of data points in the specified region(s).

$$\text{SDEV} = \sqrt{\frac{1}{n} \sum_{X_i \in \text{region}(s)} (|X_i| - \bar{X})^2}$$

where  $|X_i|$  is the magnitude of an I/Q pair,  $\bar{X}$  is the mean of the magnitudes for the specified region(s), and  $n$  is the number of data points in the specified region(s).

- PPHase - returns the x,y pairs of both rms power (dBm) and arithmetic mean phase (radian) for every specified region and frequency offset (Hz). The number of pairs is defined by the specified number of regions. This parameter can be used for I/Q vector (n=0) in Waveform (time domain) measurement and all parameters are specified by data point in PPHase.

The rms power of the specified region may be expressed as:

$$\text{Power} = 10 \times \log [10 \times (\text{RMS I/Q value})] + 10.$$

The RMS I/Q value (peak volts) is:

$$\sqrt{\frac{1}{n} \sum_{X_i \in \text{region}} X_i X_i^*}$$

where  $X_i$  is the complex value representation of an I/Q pair,  $X_i^*$  its conjugate complex number, and  $n$  is the number of I/Q pairs in the specified region.

The arithmetic mean phase of the specified region may be expressed as:

$$\frac{1}{n} \sum_{Y_i \in \text{region}} Y_i$$

where  $Y_i$  is the unwrapped phase of I/Q pair with applying frequency correction and  $n$  is the number of I/Q pairs in the specified region.

The frequency correction is made by the frequency offset calculated by the arithmetic mean of every specified region's frequency offset. Each frequency offset is calculated by the least square method against the unwrapped phase of I/Q pair.

Sample Trace Data - Constant Envelope

(See below for explanation of variables.)

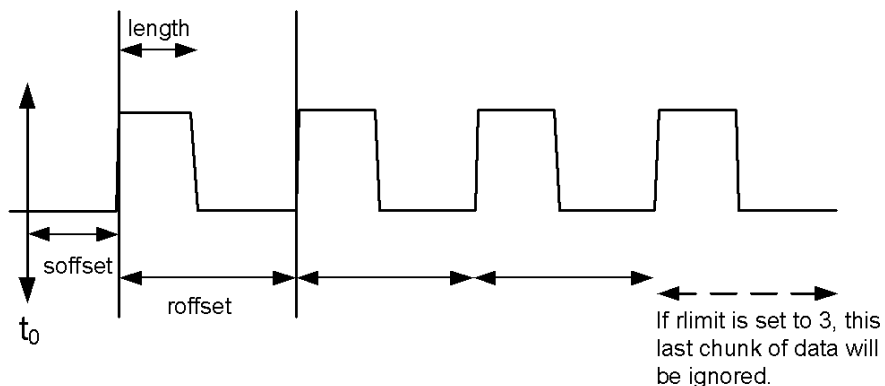

Sample Trace Data - Not Constant Envelope

(See below for explanation of variables.)

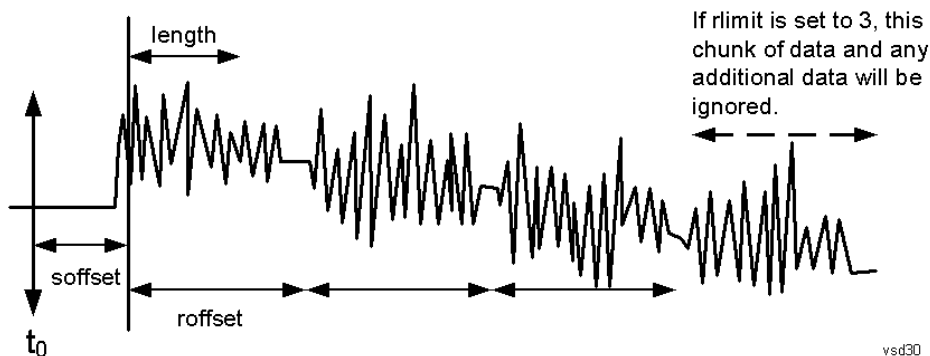

<soffset> - start offset is an optional real number. (It is in seconds for time-domain traces, and is a dimensionless index 0 to Npoints - 1, for frequency-domain traces). It specifies the amount of data at the beginning of the trace that will be ignored before the decimation process starts. It is the time or frequency change from the start of the trace to the point where you want to start using the data. The default value is zero.

<length> - is an optional real number. (It is in seconds for time-domain traces, and is a dimensionless index 0 to Npoints - 1, for frequency-domain traces). It defines how much data will be compressed into one value. This parameter has a default value equal to the current trace length.

<roffset> - repeat offset is an optional real number. (It is in seconds for time-domain traces, and is a dimensionless index 0 to Npoints - 1, for frequency-domain traces). It defines the beginning of the next field of trace elements to be compressed. This is relative to the beginning of the previous field. This parameter has a default value equal to the <length> variable. Note that this parameter is used for a completely different purpose when curve fitting (see CFIT above).

<rlimit> - repeat limit is an optional integer. It specifies the number of data items that you want returned. It will ignore any additional items beyond that number. You can use the Start offset and the Repeat limit to pick out exactly what part of the data you want to use. The default value is all the data.



## Calculate Peaks of Trace Data (Remote Command Only)

Returns a list of all the peaks for the currently selected measurement and sub-opcode [n]. The peaks must meet the requirements of the peak threshold and excursion values.

n = any valid sub-opcode for the current measurement. See the MEASure:<measurement> command description of your specific measurement for information on the data that can be returned.

The command can only be used with specific sub-opcodes with measurement results that are trace data. Both real and complex traces can be searched, but complex traces are converted to magnitude in dBm. In many measurements the sub-opcode n=0, is the raw trace data which cannot be searched for peaks. And Sub-opcode n=1, is often calculated results values which also cannot be searched for peaks.

This command uses the data setting specified by the FORMat:BORDER and FORMat:DATA commands and can return real or ASCII data. If the format is set to INT,32, it returns REAL,32 data.

The command has four types of parameters:

- Threshold (in dBm)
- Excursion (in dB)
- Sorting order (amplitude, frequency, time)
- Optional in some measurements: Display line use (all, > display line, < display line)

<b>Remote Command</b>	<p>For Swept SA measurement:</p> <pre>:CALCulate:DATA[1] 2 ... 6:PEAKs? &lt;threshold&gt;,&lt;excursion&gt;[,AMPLitude   FREQuency   TIME[,ALL   GTDLLine   LTDLine]]</pre> <p>For most other measurements:</p> <pre>:CALCulate:DATA[1] 2 ... 6:PEAKs? &lt;threshold&gt;,&lt;excursion&gt;[,AMPLitude   FREQuency   TIME]</pre>
-----------------------	---------------------------------------------------------------------------------------------------------------------------------------------------------------------------------------------------------------------------------------------------------------------------------------------------------------------------------

<b>Example</b>	<p>Example for Swept SA measurement in Spectrum Analyzer Mode:</p> <p>CALC:DATA4:PEAK? -40, 10, FREQ, GTDL This will identify the peaks of trace 4 that are above -40 dBm, with excursions of at least 10 dB. The peaks are returned in order of increasing frequency, starting with the lowest frequency. Only the peaks that are above the display line are returned.</p> <p>Query Results 1:</p> <p>With FORMat:DATA REAL, 32 selected, it returns a list of floating-point numbers. The first value in the list is the number of peak points that are in the following list. A peak point consists of two values: a peak amplitude followed by its corresponding frequency (or time).</p> <p>If no peaks are found the peak list will consist of only the number of peaks, (0).</p>
----------------	-----------------------------------------------------------------------------------------------------------------------------------------------------------------------------------------------------------------------------------------------------------------------------------------------------------------------------------------------------------------------------------------------------------------------------------------------------------------------------------------------------------------------------------------------------------------------------------------------------------------------------------------------------------------------------------------------------------------------------------------------------------------------------------------

<b>Notes</b>	<p>&lt;n&gt; - is the trace that will be used</p> <p>&lt;threshold&gt; - is the level below which trace data peaks are ignored. Note that the threshold value is required and is always used as a peak criterion. To effectively disable the threshold criterion for this command, provide a substantially low threshold value such as -200 dBm. Also note that the threshold value used in this command is independent of and has no effect on the threshold value stored under the Peak Criteria menu.</p> <p>&lt;excursion&gt; - is the minimum amplitude variation (rise and fall) required for a signal to be identified as peak. Note that the excursion value is required and is always used as a peak criterion. To effectively disable the excursion criterion for this command, provide the minimum value of 0.0 dB. Also note that the excursion value used in this command is independent of and has no effect on the</p>
--------------	---------------------------------------------------------------------------------------------------------------------------------------------------------------------------------------------------------------------------------------------------------------------------------------------------------------------------------------------------------------------------------------------------------------------------------------------------------------------------------------------------------------------------------------------------------------------------------------------------------------------------------------------------------------------------------------------------------------------------------------------------------------------------------------------------------------------------------------------------------------------------------------------------------------------------------------

---

excursion value stored under the Peak Criteria menu.

Values must be provided for threshold and excursion. The sorting and display line parameters are optional (defaults are AMPLitude and ALL).

Note that there is always a Y-axis value for the display line, regardless of whether the display line state is on or off. It is the current Y-axis value of the display line which is used by this command to determine whether a peak should be reported. Sorting order:

AMPLitude - lists the peaks in order of descending amplitude, with the highest peak first (default if optional parameter not sent)

FREQuency - lists the peaks in order of occurrence, left to right across the x-axis.

TIME - lists the peaks in order of occurrence, left to right across the x-axis.

Peaks vs. Display Line:

ALL - lists all of the peaks found (default if optional parameter not sent).

GTDLine (greater than display line) - lists all of the peaks found above the display line.

LTDLine (less than display line) - lists all of the peaks found below the display line.

---

Initial S/W Revision	Prior to A.02.00
----------------------	------------------

---

### Hardware-Accelerated Fast Power Measurement (Remote Command Only)

The Fast Power option (FP2) enables very fast channel power measurements for instruments with the prerequisite hardware (DP2 and/or B40). It accomplishes this by performing real-time overlapped FFTs at the hardware layer, using software for basic post-processing before returning the result to the user. The upshot of this approach is improved throughput for user applications that require many sequential power measurements.

The analysis bandwidth of FP2 is limited by the licenses in the instrument, but its maximum overall analysis bandwidth per acquisition is 40 MHz.

FP2 is remote-only, which means the instrument does not switch to any particular mode or measurement. FP2 commands can be sent while another application is in use on the front panel.

Each Fast Power measurement can be predefined using an array index, and up to 1,000 measurements can be stored. In the following documentation, instances of [1,2,...,999] can be substituted with a particular measurement index, e.g. CALC:FPOW:POW1?, CALC:FPOW:POW2?, CALC:FPOW:POW134?. In this way, power measurements can be defined one time in a batch, and then executed multiple times without having to redefine them, similar to “list mode” on other measurements.

In addition to basic channel power measurements, there are a number of other measurement “functions” for each channel, including peak power, peak frequency, and power spectral density. See the Function parameter for more information.

### Reset Fast Power Measurement (Remote Command Only)

Resets the measurement configuration to the defaults.

---

<b>Mode</b>	All
<b>Remote Command</b>	:CALCulate:FPOWer:POWer [1, 2, ..., 999] :RESet
<b>Example</b>	:CALC:FPOW:POW1:RES

---

Notes	Option FP2 is required.
Initial S/W Revision	A.14.00

### Define Fast Power Measurement (Remote Command Only)

Fast Power acquisitions are configured using the DEFine command. This command accepts a comma-delimited string of configuration parameters and their appropriate values, which are all specified in the subsection below.

Mode	All
<b>Remote Command</b>	:CALCulate:FPOWer:POWer[1,2,...,999]:DEFine "configuration string"
<b>Example</b>	:CALC:FPOW:POW1:DEF "CenterFrequency=2e9, AcquisitionTime=0.005"
Notes	See below for a list of measurement variables that can be defined in the configuration string.
Initial S/W Revision	A.14.00

### Acquisition Time

Example	CALC:FPOW:POW1:DEF "AcquisitionTime=0.002"
Notes	The acquisition time parameter sets the time in which the entire spectrum is measured. An increase in the acquisition time yields an improvement in measurement repeatability.
Preset	0.001 s
Range	0 s to 1 s
Default Unit	Time (s)
Initial S/W Revision	A.14.00

### Center Frequency

Example	CALC:FPOW:POW1:DEF "CenterFrequency=2e9"
Notes	The center frequency parameter sets the frequency in which the measurement is centered around. The OffsetFrequency parameter is calculated relative to the center frequency.
Preset	1 GHz
Range	0 Hz to maximum instrument frequency
Default Unit	Frequency (Hz)
Initial S/W Revision	A.14.00

### DC Coupled

Example	CALC:FPOW:POW1:DEF "DCCoupled=True"
Notes	The DC coupled parameter allows the user to specify whether the DC blocking capacitor is utilized. Set parameter to true when measuring frequencies below 10 MHz.
Preset	False
Range	True (DC Coupled) or False (AC Coupled)
Default Unit	Boolean
Initial S/W Revision	A.14.00

### DetectorType

Example	CALC:FPOW:POW1:DEF "DetectorType=Peak"
Notes	Option FP2 is required. The detector type parameter allows the user to choose whether a RMS average or peak value is used during the measurement.
Preset	RmsAverage
Range	RmsAverage, Peak
Initial S/W Revision	A.14.00

### Do Noise Correction

Example	CALC:FPOW:POW1:DEF "DoNoiseCorrection=True"
Notes	When noise correction is enabled, the linear noise power contributed by the analyzer is subtracted from all measurements. This effectively lowers the noise floor of the analyzer. When noise correction is enabled, the first measurement for a given set of input parameters will take extra time. This is because the analyzer takes an extra acquisition with the RF input disconnected from the analyzer's front end to measure the noise of just the analyzer. The measured noise floor is stored in a cache so the noise acquisition will occur only once for the same state settings. In other words, if noise correction was turned on and the analyzer made an acquisition at frequency A, then frequency B, and back again to frequency A, the hidden initial noise floor acquisition would only occur for the first acquisition at frequency A and the cached noise floor would be used the second time frequency A was measured.
Preset	False
Range	True (enable noise correction) or False (disable noise correction)
Default Unit	Boolean
Initial S/W Revision	A.14.00

## Do Spur Suppression

Example	CALC:FPOW:POW1:DEF "DoSpurSuppression=True"
Notes	<p>When measuring very low level signals, or when large out-of-band inputs are input into the analyzer, sometimes unwanted spurs and residuals can appear in the measured spectrum. Spur suppression is a method to help minimize the levels of these internally generated spurs and residuals.</p> <p>When spur suppression is enabled, the analyzer will automatically take two acquisitions using two different internal analog LO frequencies. The FFT spectrums from both acquisitions are combined by taking the minimum power between both traces on a per FFT bin basis. External signals will have the same amplitude for both traces and therefore will return the expected amplitudes. However, low level spurs and residuals generated internally to the analyzer tend to move to different FFT bins depending on the internal analog LO frequency used, and therefore tend to be suppressed using this spur suppression method.</p> <p>Because two acquisitions, rather than a single acquisition, are made when spur suppression is enabled, the measurement time will always be slower when spur suppression is enabled.</p>
Preset	False
Range	True (enable spur suppression) or False (disable spur suppression)
Default Unit	Boolean
Initial S/W Revision	A.14.00

## Electronic Attenuator Bypass

Example	CALC:FPOW:POW1:DEF "ElecAttBypass =False"
Notes	The electronic attenuation bypass parameter allows the user to either utilize or bypass the electronic attenuator. The electronic attenuator is only available for frequencies up to 3.6 GHz. Set parameter to true when using frequencies above 3.6 GHz and set the parameter to false when using the preamp.
Preset	True
Range	True (bypass electronic attenuator) or False (use electronic attenuator)
Default Unit	Boolean
Initial S/W Revision	A.14.00

## Electronic Attenuation

Example	CALC:FPOW:POW1:DEF "ElecAttenuation=10"
Notes	<p>Option EA3 is required.</p> <p>The electronic attenuation value parameter sets the amount of electrical attenuation from 0 to 24 dB (1 dB steps).</p> <p>Set "ElecAttBypass=False" to make sure the electronic attenuator path is enabled.</p>
Preset	0 dB
Range	0 - 24 dB (1 dB steps)

Default Unit	dB
Initial S/W Revision	A.14.00

#### IF Gain

Example	CALC:FPOW:POW1:DEF "IFGain=10"
Notes	The IF gain parameter allows the user to specify the gain at the IF stage anywhere from -6 to 16 dB (1 dB steps). This is an advanced feature, and for most cases this should remain at its default value of 0 dB.
Preset	0 dB
Range	-6 - 16 dB (1 dB steps)
Default Unit	dB
Initial S/W Revision	A.14.00

#### IF Type

Example	CALC:FPOW:POW1:DEF "IFType=B25M"
Notes	The IF type parameter allows the user to select between different IF paths. For example, if the signal is less than 25 MHz wide, then the user can select the B25M path to take advantage of additional filtering on this analog IF path.
Preset	B40M
Range	B10M, B25M, B40M
Initial S/W Revision	A.14.00

#### Include Power Spectrum

Example	CALC:FPOW:POW1:DEF "IncludePowerSpectrum=True"
Notes	The power spectrum parameter allows the user to read data on the entire spectrum for diagnostic purposes. It is not recommended for production use. See CALC:FPOW:POW[n]:READ2? for details on the binary format of the response.
Preset	False
Range	True (return both channel power and full power spectrum) or False (returns only channel power)
Default Unit	Boolean
Initial S/W Revision	A.14.00

## Mechanical Attenuation

Example	CALC:FPOW:POW1:DEF "MechAttenuation=10"
Notes	The mechanical attenuation value parameter sets the amount of mechanical attenuation anywhere from 0 to 70 dB (2 dB steps).
Preset	0 dB
Range	0 – 70 dB (2 dB steps)
Default Unit	dB
Initial S/W Revision	A.14.00

## Preamp Mode

Example	CALC:FPOW:POW1:DEF "PreAmpMode=Low"
Notes	The license for the appropriate preamp is required. The preamp mode parameter specifies whether the preamps are being utilized. Low allows any preamps up to 3.6 GHz, and Full allows all licensed preamps. Set "ElecAttBypass=True" in order to utilize any preamps.
Preset	Off
Range	Off, Low, Full
Initial S/W Revision	A.14.00

## Resolution Bandwidth Mode

Example	CALC:FPOW:POW1:DEF "PreAmpMode=Low"
Notes	The resolution bandwidth mode parameter allows the user to choose whether the RBW filter is automatically or manually set. The BestSpeed value minimizes measurement time, while the Narrowest value minimizes RBW size (minimum of two FFT bins per RBW). To manually specify an RBW, set this parameter to Explicit, and set the ResolutionBW parameter to the desired value.
Preset	BestSpeed
Range	BestSpeed, Narrowest, Explicit
Initial S/W Revision	A.14.00

## Resolution Bandwidth

Example	CALC:FPOW:POW1:DEF "ResolutionBW=25e3"
Notes	The resolution bandwidth parameter sets the 3-dB bandwidth of the RBW filter. The ResolutionBWMode parameter must be set to Explicit in order to manually set the RBW.

Preset	0 Hz
Default Unit	Hz
Initial S/W Revision	A.14.00

#### Trigger Delay

Example	CALC:FPOW:POW1:DEF "TriggerDelay=0.025"
Notes	The trigger delay parameter sets the time after an external trigger is detected until the measurement is performed.
Preset	0 s
Range	0 - 1 s
Default Unit	Seconds
Initial S/W Revision	A.14.00

#### Trigger Level

Example	CALC:FPOW:POW1:DEF "TriggerLevel=2"
Notes	The trigger level parameter sets the voltage value at which an external trigger is detected.
Preset	1.2 V
Range	-5 to 5 V
Default Unit	Volts
Initial S/W Revision	A.14.00

#### Trigger Slope

Example	CALC:FPOW:POW1:DEF "TriggerSlope=Negative"
Notes	The trigger slope parameter indicates the direction of the edge trigger voltage for detection.
Preset	Positive
Range	Positive, Negative
Initial S/W Revision	A.14.00



## Trigger Source

Example	CALC:FPOW:POW1:DEF "TriggerSource=Ext1"
Notes	The trigger source parameter allows the user to choose between measurement's triggering freely or controlled by an external input. Ext1 and Ext2 correspond to Trigger 1 In and Trigger 2 In, respectively.
Preset	Free
Range	Free, Ext1, Ext2
Initial S/W Revision	A.14.00

## Trigger Timeout

Example	CALC:FPOW:POW1:DEF "TriggerTimeout=0.1"
Notes	The trigger timeout parameter sets the time in which the analyzer will wait for a trigger before automatically performing the measurement.
Preset	1 s
Range	0 – 1 s
Default Unit	Seconds
Initial S/W Revision	A.14.00

## Signal Input

Example	CALC:FPOW:POW1:DEF "SignalInput=Fp50MHzCW"
Notes	The signal input parameter allows the user to select between using the main RF input or the internal analyzer reference CW signal of 50 MHz.
Preset	FpMainRf
Range	FpMainRf, Fp50MHzCW
Initial S/W Revision	A.14.00

## Use Preselector

Example	CALC:FPOW:POW1:DEF "UsePreSelector=True"
Notes	The preselector parameter allows the user to either utilize or bypass the front end tunable filter at frequencies above 3.6 GHz. For frequencies below 3.6 GHz, the preselector is automatically bypassed, so you do not need to set this parameter to False in those cases.
Preset	False
Range	True (use preselector above 3.6 GHz), or False (preselector bypassed)

Default Unit	Boolean
Initial S/W Revision	A.14.00

### Channel Bandwidth Array

Example	CALC:FPOW:POW1:DEF "Bandwidth=[3.84e6, 5e6, 3.84e6]"
Notes	The bandwidth parameter array defines the bandwidth of each channel that will be measured. All array parameters should have the same number of elements. Alternatively, if all the elements are the same value, a single number with no square brackets can be used to define the parameter.
Preset	[1e6]
Range	0 to 40 MHz
Default Unit	Hz
Initial S/W Revision	A.14.00

### Channel Filter Type Array

Example	CALC:FPOW:POW1:DEF "FilterType=[RRC, IBW, RRC]"
Notes	The filter type parameter allows the user to choose between an integration bandwidth (IBW) filter or a root-raised-cosine (RRC) filter. The integration bandwidth filter weighs all frequencies within the bandwidth equally. The root-raised-cosine filter has an associated shape parameter, defined by the FilterAlpha parameter. All array parameters should have the same number of elements. Alternatively, if all the elements are the same value, a single value with no square brackets can be used to define the parameter.
Preset	[IBW]
Range	IBW, RRC
Initial S/W Revision	A.14.00

### Channel Filter Alpha Array

Example	CALC:FPOW:POW1:DEF "FilterAlpha=[0.5, 0.0, 0.5]"
Notes	The filter alpha parameter allows the user to adjust the alpha value associated with the root-raised-cosine (RRC) filter type. Set FilterType to RRC in order to utilize this parameter. All array parameters should have the same number of elements. Alternatively, if all the elements are the same value, a single number with no square brackets can be used to define the parameter.
Preset	[0.22]
Range	0.0 - 1.0

Initial S/W Revision	A.14.00
-------------------------	---------

### Channel Measurement Function Array

Example	CALC:FPOW:POW1:DEF "Function=[BandPower, PeakPower, BandPower]"
Notes	<p>This parameter array defines what measurement is being made for each individually-specified channel:</p> <p>BandPower: Total power within the specified bandwidth of the channel (dBm)</p> <p>BandDensity: Total power density within the specified bandwidth of the channel (dBm/Hz)</p> <p>PeakPower: The peak power value within the specified bandwidth of the channel (dBm)</p> <p>PeakFrequency: The frequency which corresponds to the peak power value within the specified bandwidth of the channel. This frequency is relative to the center frequency (Hz)</p> <p>XdBBandwidth: The half power (-3.01 dB) bandwidth of the highest amplitude signal that resides within the channel (Hz), dB is configurable using XdBBandwidth parameter</p> <p>OccupiedBandwidth: The bandwidth at which 99% of the total power resides within the channel (Hz), percentage configurable using OccupiedBandwidthPercent parameter</p> <p>All array parameters should have the same number of elements. Alternatively, if all the elements are the same value, a single value with no square brackets can be used to define the parameter.</p>
Preset	[BandPower]
Range	BandPower, BandDensity, PeakPower, PeakFrequency, XdBBandwidth, OccupiedBandwidth
Initial S/W Revision	A.14.00

### Channel Offset Frequency Array

Example	CALC:FPOW:POW1:DEF "OffsetFrequency=[-5e6, 0, 5e6]"
Notes	<p>The offset frequency parameter array defines the difference between the center frequency to the center frequency of each channel.</p> <p>All array parameters should have the same number of elements.</p>
Preset	[0]
Range	0 to 20 MHz
Default Unit	Hz
Initial S/W Revision	A.14.00

### Channel Occupied Bandwidth Percent Array

Example	CALC:FPOW:POW1:DEF "OccupiedBandwidthPercent =[0.95, 0.95, 0.95]"
Notes	This parameter only applies for channels whose Function is set to OccupiedBandwidth. The occupied

	bandwidth percent parameter specifies the percent of total power in these channels. The valid range for this parameter is 0.0 to 1.0, where 1.0 represents 100%. The default for this parameter is 0.99, which will return the bandwidth that contains 99% of the total channel power.
Preset	[0.99]
Range	0 - 1.0
Initial S/W Revision	A.14.00

#### Channel x-dB Bandwidth Array

Example	CALC:FPOW:POW1:DEF " XdBBandwidth =[-6.02, -3.01, -1.0]"
Notes	This parameter only applies for channels whose Function is set to XdBBandwidth. The X dB bandwidth parameter is used to specify the power relative to the peak channel power over which the bandwidth is calculated. The parameter value must be a negative number.
Preset	[-3.01]
Range	-200 to 0 dB
Default Unit	dB
Initial S/W Revision	A.14.00

#### Define Fast Power Measurement Query (Remote Command Only)

The DEFine? command is used to retrieve a list of all defined parameters in an ASCII string format

M All  
o  
d  
e

R :CALCulate:FPOWer:POWer[1,2,...,999]:DEFine?

e  
m  
o  
t  
e

C  
o  
m  
m  
a  
n  
d

E :CALC:FPOW:POW1:DEF?

x  
a  
m  
p  
l  
e

N This command query is used to retrieve a list of all defined parameters in an ASCII format.

O The following is an example of the returned results:

S "DCCoupled=False,ElecAttBypass=True,ElecAttenuation=0,IFGain=0,MechAttenuation=0,PreAmpMode=Off,PreSelectorOffset=0,UsePreSelector=False,ExternalReferenceFrequency=1000000,FrequencyReferenceSource=AutoExternalFrequencyReference,IFType=B40M,LOMode=SLW,SignalInput=FpMainRf,AcquisitionTime=0.001,CenterFrequency=100000000,ResolutionBW=0,ResolutionBWMode=BestSpeed,DetectorType=RmsAverage,Bandwidth=[1000000],OffsetFrequency=[0],Function=[BandPower],FilterType=[IBW],FilterAlpha=[0.22],OccupiedBandwidthPercent=[0.99],XdBBandwidth=[-3.01],DoNoiseCorrection=False,DoSpurSuppression=False,MeasurementMethod=HardwareFFT,IncludePowerSpectrum=False,TriggerDelay=0,TriggerLevel=1.2,TriggerSlope=Positive,TriggerSource=Free,TriggerTimeout=1"

I A.14.00

n  
i  
t  
i  
a  
l

S  
/  
W

R  
e  
v  
i  
s  
i  
o  
n

### Configure Fast Power Measurement (Remote Command Only)

The configure command begins hardware setup and returns immediately, with no acquisition made. This can be used in parallel with other hardware operations to effectively hide the hardware setup time.

Mode	All
<b>Remote Command</b>	:CALCulate:FPOWER:POWer[1,2,...,999]:CONFigure
<b>Example</b>	:CALC:FPOW:POW1:CONF
Notes	Option FP2 is required.
Initial S/W Revision	A.14.00

### Initiate Fast Power Measurement (Remote Command Only)

The INITiate command begins an acquisition and returns immediately. The results of the measurement can be retrieved using FETCh.

Mode	All
<b>Remote Command</b>	:CALCulate:FPOWER:POWER[1,2,...,999]:INITiate
<b>Example</b>	:CALC:FPOW:POW1:INIT
Notes	Option FP2 is required.
Initial S/W Revision	A.14.00

### Fetch Fast Power Measurement (Remote Command Only)

The FETCh command query is used to retrieve the results of an acquisition initiated by the INIT command. The returned results are in ASCII string format. The string begins and ends with quotation marks.

Mode	All
<b>Remote Command</b>	:CALCulate:FPOWER:POWER[1,2,...,999]:FETCh?
<b>Example</b>	:CALC:FPOW:POW1:FETC?
Notes	Option FP2 is required. Returns m comma-separated ASCII values, where m corresponds to the number of bandwidths defined. 1. Declared function return in the 1st specified channel 2. Declared function return in the 2nd specified channel ... m. Declared function return in the last specified channel The INIT and FETC? command sequence performs the same functionality of a single CALC:FPOW:POW[n]? query. Units of the returned values are dependent on the Function parameter for each channel.
Initial S/W Revision	A.14.00

### Execute Fast Power Measurement (Remote Command Only)

This command query is used as shorthand for an INIT command immediately followed by a FETC? command. The returned results are in ASCII string format. The string begins and ends with quotation marks.

Mode	All
<b>Remote Command</b>	:CALCulate:FPOWER:POWER[1,2,...,999]?
<b>Example</b>	:CALC:FPOW:POW1?

Notes	Option FP2 is required. See notes for Fast Power Fetch for return format.
Initial S/W Revision	A.14.00

### Binary Read Fast Power Measurement (Remote Command Only)

This command query is used as shorthand for an INIT command immediately followed by a FETC? command. The returned results are in a binary format.

Mode	All
<b>Remote Command</b>	:CALCulate:FPOWER:POWER[1,2,...,999]:READ? :CALCulate:FPOWER:POWER[1,2,...,999]:READ1?
<b>Example</b>	:CALC:FPOW:POW1:READ? :CALC:FPOW:POW1:READ1?
Notes	Option FP2 is required. Returns m 4 byte floating point binary values (Little-Endian), where m corresponds to the number of bandwidths defined.
Initial S/W Revision	A.14.00

### Diagnostic Binary Read Fast Power Measurement (Remote Command Only)

This command query is used as shorthand for an INIT command immediately followed by a FETC? command. The returned results are in a binary format. This command is used primarily for diagnostic purposes to test for ADC overloads and to visibly inspect the spectrum.

Mode	All
<b>Remote Command</b>	:CALCulate:FPOWER:POWER[1,2,...,999]:READ2?
<b>Example</b>	:CALC:FPOW:POW1:READ2?
Notes	Option FP2 is required. Note: Spectrum data is only returned if the IncludePowerSpectrum parameter is set to True. If IncludePowerSpectrum is False, the number of spectrum points will be zero (0). Units of the returned values are dependent on the Function parameter per channel (e.g. dBm for BandPower, Hz for PeakFrequency). Returns binary data (Little-Endian) that contains information on m amount of channels, along with ADC over range and full spectrum data. The following is the binary format of the response. Bandwidth Return Value 1. Number of channels specified, m [4 byte int] 2. Declared function result for the 1st specified channel [4 byte float]

---

	3. Declared function result for the 2nd specified channel [4 byte float]
	...
	(m + 1). Declared function result for the last (mth) specified channel [4 byte float]
	ADC Over Range
	1. ADC over-range occurred (1: true, 0: false) [2 byte short]
	Spectrum Data
	1. Number of points in the spectrum data, k [4 byte int]
	2. Start frequency of spectrum data (Hz) [8 byte double]
	3. Step frequency of spectrum data (Hz) [8 byte double]
	4. FFT bin at 1st point (dBm) [4 byte float]
	5. FFT bin at 2nd point (dBm) [4 byte float]
	...
	(k + 3). FFT bin at last (kth) point (dBm) [4 byte float]

---

Initial S/W	A.14.00
Revision	

---

### Format Data: Numeric Data (Remote Command Only)

This command specifies the format of the trace data input and output. It specifies the formats used for trace data during data transfer across any remote port. It affects only the data format for setting and querying trace data for the :TRACe[:DATA], TRACe[:DATA]?, :CALCulate:DATA[n]? and FETCh:SANalyzer [n]? commands and queries.

---

<b>Remote Command</b>	:FORMat [:TRACe] [:DATA] ASCii   INTeger, 32   REAL, 32   REAL, 64 :FORMat [:TRACe] [:DATA] ?
<b>Notes</b>	The query response is: ASCii: ASC,8 REAL,32: REAL,32 REAL,64: REAL,64 INTeger,32: INT,32 When the numeric data format is REAL or ASCii, data is output in the current Y Axis unit. When the data format is INTeger, data is output in units of m dBm (.001 dBm). The INT,32 format returns binary 32-bit integer values in internal units (m dBm), in a definite length block.
<b>Dependencies</b>	Sending a data format spec with an invalid number (for example, INT,48) generates no error. The analyzer simply uses the default (8 for ASCii, 32 for INTeger, 32 for REAL). Sending data to the analyzer which does not conform to the current FORMat specified, results in an error. Sending ASCII data when a definite block is expected generates message -161 "Invalid Block Data" and sending a definite block when ASCII data is expected generates message -121 "Invalid Character in Number".
<b>Preset</b>	ASCii
<b>Backwards Compatibility</b>	Note that the INT,32 format is only applicable to the command, TRACe:DATA. This preserves

---



Notes	backwards compatibility for the Swept SA measurement. For all other commands/queries which honor FORMat:DATA, if INT,32 is sent the analyzer will behave as though it were set to REAL,32.
Initial S/W Revision	Prior to A.02.00

The specs for each output type follow:

ASCIi - Amplitude values are in ASCII, in the current Y Axis Unit, one ASCII character per digit, values separated by commas, each value in the form:

SX.YYYYYEsZZ

Where:

S = sign (+ or -)

X = one digit to left of decimal point

Y = 5 digits to right of decimal point

E = E, exponent header

s = sign of exponent (+ or -)

ZZ = two digit exponent

REAL,32 - Binary 32-bit real values in the current Y Axis Unit, in a definite length block.

REAL,64 - Binary 64-bit real values in the current Y Axis Unit, in a definite length block.

### Format Data: Byte Order (Remote Command Only)

This command selects the binary data byte order for data transfer and other queries. It controls whether binary data is transferred in normal or swapped mode. This command affects only the byte order for setting and querying trace data for the :TRACe[:DATA], TRACe[:DATA]? , :CALCulate:DATA[n]? and FETCh:SANalyzer[n]? commands and queries.

By definition any command that says it uses FORMat:DATA uses any format supported by FORMat:DATA.

The NORMal order is a byte sequence that begins with the most significant byte (MSB) first, and ends with the least significant byte (LSB) last in the sequence: 1|2|3|4. SWAPped order is when the byte sequence begins with the LSB first, and ends with the MSB last in the sequence: 4|3|2|1.

<b>Remote Command</b>	:FORMat:BORDER NORMal   SWAPped :FORMat:BORDER?
Preset	NORMal
Initial S/W Revision	Prior to A.02.00

## Meas Setup

Accesses a menu that enables you to set measurement setup parameters.

Key Path	Meas Setup
Initial S/W Revision	Prior to A.02.00

### Avg/Hold Num

Sets the number of data acquisitions that will be averaged. After the specified number of average counts, the averaging mode setting determines the averaging action.

Key Path	Meas Setup
Mode	WIMAXOFDMA
<b>Remote Command</b>	[ :SENSe ] :EVM:AVERage:COUNT <integer> [ :SENSe ] :EVM:AVERage:COUNT? [ :SENSe ] :EVM:AVERage [ :STATe ] OFF ON 0 1 [ :SENSe ] :EVM:AVERage [ :STATe ] ?
<b>Example</b>	EVM:AVER:COUN 100 EVM:AVER:COUN? EVM:AVER OFF EVM:AVER?
Preset	10 OFF
State Saved	Saved in instrument state.
Min	1
Max	10000
Initial S/W Revision	Prior to A.02.00

### Avg Mode

Selects the type of termination control used for the averaging function. This determines the averaging action after the specified number of data acquisitions (average count) is reached.

KEYExponential averaging SCPIEXPponential	When Measure is set at Cont, data acquisitions will continue indefinitely. After N averages, exponential averaging is used with a weighting factor of N (the displayed average count stops at N). Exponential averaging weights new data more than old data, which enables tracking of slow-changing signals.
KEYRepeat averaging SCPIREPeat	When Measure is set at Cont, data acquisitions will continue indefinitely. After N averages is reached, all previous result data is cleared and the average count is set back to 1. This is equivalent to

---

being in Measure Single and pressing the Restart key when the Single measurement finishes.

---

Key Path	Meas Setup
Mode	WIMAXOFDMA
<b>Remote Command</b>	[ :SENSe ] :EVM:AVERage:TCONtrol EXPonential REPeat [ :SENSe ] :EVM:AVERage:TCONtrol?
<b>Example</b>	EVM:AVER:TCON EXP EVM:AVER:TCON?
Preset	REPeat
State Saved	Saved in instrument state.
Range	Exp Repeat
Initial S/W Revision	Prior to A.02.00

### Limits

Accesses measurement setup limit parameters.

Key Path	Meas Setup
Initial S/W Revision	Prior to A.02.00

### RMS RCE

Accesses RMS RCE measurement setup limit parameters.

Key Path	Meas Setup, Limits
Initial S/W Revision	Prior to A.02.00

### Limits

Sets the limit state for the RMS EVM measurement pass/fail test.

Key Path	Meas Setup, Limits, RMS RCE
Mode	WIMAXOFDMA
<b>Remote Command</b>	:CALCulate:EVM:LIMit [1]   2:RRCE:STATe OFF ON 0 1 :CALCulate:EVM:LIMit [1]   2:RRCE:STATe?
<b>Example</b>	CALC:EVM:LIM:RRCE:STAT ON CALC:EVM:LIM:RRCE:STAT?

Notes	LIMit1 is for BS, 2 for MS. Default is BS.
Preset	ON
State Saved	Saved in instrument state.
Range	On Off
Initial S/W Revision	Prior to A.02.00

### Composite

Sets the limit for RMS RCE measurement pass/fail test.

Key Path	Meas Setup, Limits, RMS RCE
Mode	WIMAXOFDMA
<b>Remote Command</b>	:CALCulate:EVM:LIMit[1] 2:RRCE <rel_ampl> :CALCulate:EVM:LIMit[1] 2:RRCE? :CALCulate:EVM:LIMit[1] 2:RRCE:AUTO 0 1 OFF ON :CALCulate:EVM:LIMit[1] 2:RRCE:AUTO?
<b>Example</b>	CALC:EVM:LIM:RRCE -50 CALC:EVM:LIM:RRCE? CALC:EVM:LIM:RRCE:AUTO 0 CALC:EVM:LIM:RRCE:AUTO?
Notes	LIMit1 is for BS, 2 for MS. Default is BS.
Couplings	Mode: Auto The actual limit value depends on the modulation type when single burst was focused. The limit value is selected by the detected modulation type automatically. If composite burst was focused, the manual limit value is used. Mode: Manual The Limit value is used for single or composite burst types.
Preset	0.00 1
State Saved	Saved in instrument state.
Min	-100
Max	0.00
Initial S/W Revision	Prior to A.02.00

### QPSK-1/2

Sets the limit of the QPSK coding rate 1/2 burst for the RMS RCE measurement pass/fail test.

Key Path	Meas Setup, Limits, RMS RCE
----------	-----------------------------

Mode	WIMAXOFDMA
<b>Remote Command</b>	:CALCulate:EVM:LIMit[1] 2:RRCE:QPSK:R1B2 <rel_ampl> :CALCulate:EVM:LIMit[1] 2:RRCE:QPSK:R1B2?
<b>Example</b>	CALC:EVM:LIM:RRCE:QPSK:R1B2 -10.0 CALC:EVM:LIM:RRCE:QPSK:R1B2?
Notes	LIMit1 is for BS, 2 for MS. Default is BS.
Preset	-15
State Saved	Saved in instrument state.
Min	-100.0
Max	0.0
Initial S/W Revision	Prior to A.02.00

### QPSK-3/4

Sets the limit of the QPSK coding rate 3/4 burst for the RMS RCE measurement pass/fail test.

Key Path	Meas Setup, Limits, RMS RCE
Mode	WIMAXOFDMA
<b>Remote Command</b>	:CALCulate:EVM:LIMit[1] 2:RRCE:QPSK:R3B4 <rel_ampl> :CALCulate:EVM:LIMit[1] 2:RRCE:QPSK:R3B4?
<b>Example</b>	CALC:EVM:LIM:RRCE:QPSK:R3B4 -10.0 CALC:EVM:LIM:RRCE:QPSK:R3B4?
Notes	LIMit1 is for BS, 2 for MS. Default is BS.
Preset	-18
State Saved	Saved in instrument state.
Min	-100.0
Max	0.0
Initial S/W Revision	Prior to A.02.00

### 16QAM-1/2

Sets the limit of the 16QAM coding rate 1/2 burst for the RMS RCE measurement pass/fail test.

Key Path	Meas Setup, Limits, RMS RCE
Mode	WIMAXOFDMA
<b>Remote Command</b>	:CALCulate:EVM:LIMit[1] 2:RRCE:QA16:R1B2 <rel_ampl> :CALCulate:EVM:LIMit[1] 2:RRCE:QA16:R1B2?
<b>Example</b>	CALC:EVM:LIM:RRCE:QA16:R1B2 -10.0 CALC:EVM:LIM:RRCE:QA16:R1B2?

Notes	LIMit1 is for BS, 2 for MS. Default is BS.
Preset	-20.5
State Saved	Saved in instrument state.
Min	-100.00
Max	0
Initial S/W Revision	Prior to A.02.00

### 16QAM-3/4

Sets the limit of the 16QAM coding rate 3/4 burst for the RMS RCE measurement pass/fail test.

Key Path	Meas Setup, Limits, RMS RCE
Mode	WIMAXOFDMA
<b>Remote Command</b>	:CALCulate:EVM:LIMit[1] 2:RRCE:QA16:R3B4 <rel_ampl> :CALCulate:EVM:LIMit[1] 2:RRCE:QA16:R3B4?
<b>Example</b>	CALC:EVM:LIM:RRCE:QA16:R3B4 -10.0 CALC:EVM:LIM:RRCE:QA16:R3B4?
Notes	LIMit1 is for BS, 2 for MS. Default is BS.
Preset	-24.0
State Saved	Saved in instrument state.
Min	-100.0
Max	0.0
Initial S/W Revision	Prior to A.02.00

### 64QAM-1/2

Sets the limit of the 64QAM coding rate 1/2 burst for the RMS RCE measurement pass/fail test.

Key Path	Meas Setup, Limits, RMS RCE, More
Mode	WIMAXOFDMA
<b>Remote Command</b>	:CALCulate:EVM:LIMit[1]:RRCE:QA64:R1B2 <rel_ampl> :CALCulate:EVM:LIMit[1]:RRCE:QA64:R1B2?
<b>Example</b>	CALC:EVM:LIM:RRCE:QA64:R1B2 -10.0 CALC:EVM:LIM:RRCE:QA64:R1B2?
Preset	-15
State Saved	Saved in instrument state.
Min	-100.00
Max	0.00
Initial S/W Revision	Prior to A.02.00

### 64QAM-2/3

Sets the limit of the 64QAM coding rate 2/3 burst for the RMS RCE measurement pass/fail test.

Key Path	Meas Setup, Limits, RMS RCE, More
Mode	WIMAXOFDMA
Remote Command	:CALCulate:EVM:LIMit[1]:RRCE:QA64:R2B3 <rel_amp1> :CALCulate:EVM:LIMit[1]:RRCE:QA64:R2B3?
Example	CALC:EVM:LIM:RRCE:QA64:R2B3 -10.0 CALC:EVM:LIM:RRCE:QA64:R2B3?
Preset	-18
State Saved	Saved in instrument state.
Min	-100.00
Max	0.00
Initial S/W Revision	Prior to A.02.00

### 64QAM-3/4

Sets the limit of the 64QAM coding rate 3/4 burst for the RMS RCE measurement pass/fail test.

Key Path	Meas Setup, Limits, RMS RCE, More
Mode	WIMAXOFDMA
Remote Command	:CALCulate:EVM:LIMit[1]:RRCE:QA64:R3B4 <rel_amp1> :CALCulate:EVM:LIMit[1]:RRCE:QA64:R3B4?
Example	CALC:EVM:LIM:RRCE:QA64:R3B4 -10.0 CALC:EVM:LIM:RRCE:QA64:R3B4?
Preset	-18
State Saved	Saved in instrument state.
Min	-100.00
Max	0.00
Initial S/W Revision	Prior to A.02.00

### Peak RCE

Sets the limit for the Peak RCE measurement pass/fail test.

Key Path	Meas Setup, Limits
Mode	WIMAXOFDMA
Remote Command	:CALCulate:EVM:LIMit[1] 2:PRCE <rel_amp1>

	:CALCulate:EVM:LIMit[1] 2:PRCE?
	:CALCulate:EVM:LIMit[1] 2:PRCE:STATe OFF ON 0 1
	:CALCulate:EVM:LIMit[1] 2:PRCE:STATe?
<b>Example</b>	CALC:EVM:LIM:PRCE -50 CALC:EVM:LIM:PRCE? CALC:EVM:LIM:PRCE:STAT ON CALC:EVM:LIM:PRCE:STAT?
Notes	LIMit1 is for BS, 2 for MS. Default is BS.
Preset	0.00 OFF
State Saved	Saved in instrument state.
Min	-100
Max	0.00
Initial S/W Revision	Prior to A.02.00

## Pilot RCE

Sets the limit for the Pilot RCE measurement pass/fail test.

Key Path	Meas Setup, Limits
Mode	WIMAXOFDMA
<b>Remote Command</b>	:CALCulate:EVM:LIMit[1] 2:RCEPilot <rel_ampl> :CALCulate:EVM:LIMit[1] 2:RCEPilot? :CALCulate:EVM:LIMit[1] 2:RCEPilot:STATe OFF ON 0 1 :CALCulate:EVM:LIMit[1] 2:RCEPilot:STATe?
<b>Example</b>	CALC:EVM:LIM:RCEP -50 CALC:EVM:LIM:RCEP? CALC:EVM:LIM:RCEP:STAT ON CALC:EVM:LIM:RCEP:STAT?
Notes	LIMit1 is for BS, 2 for MS. Default is BS.
Preset	0.00 OFF
State Saved	Saved in instrument state.
Min	-100
Max	0.00
Initial S/W Revision	Prior to A.02.00



## Frequency Error

Sets the limit in ppm for the absolute Frequency Error measurement pass/fail test.

Key Path	Meas Setup, Limits
Mode	WIMAXOFDMA
<b>Remote Command</b>	:CALCulate:EVM:LIMit[1] 2:FERRor <real> :CALCulate:EVM:LIMit[1] 2:FERRor? :CALCulate:EVM:LIMit[1] 2:FERRor:STATe OFF ON 0 1 :CALCulate:EVM:LIMit[1] 2:FERRor:STATe?
<b>Example</b>	CALC:EVM:LIM:FERR 50 CALC:EVM:LIM:FERR? CALC:EVM:LIM:FERR:STAT ON CALC:EVM:LIM:FERR:STAT?
Notes	LIMit1 is for BS, 2 for MS. Default is BS.
Preset	2.00 ON
State Saved	Saved in instrument state.
Min	0
Max	100
Initial S/W Revision	Prior to A.02.00

## Time Offset

Sets the limit for the Time Offset measurement pass/fail test.

Key Path	Meas Setup, Limits
Mode	WIMAXOFDMA
<b>Remote Command</b>	:CALCulate:EVM:LIMit[1] 2:TOFFset <time> :CALCulate:EVM:LIMit[1] 2:TOFFset? :CALCulate:EVM:LIMit[1] 2:TOFF:STATe OFF ON 0 1 :CALCulate:EVM:LIMit[1] 2:TOFF:STATe?
<b>Example</b>	CALC:EVM:LIM:TOFF 100e-3 CALC:EVM:LIM:TOFF? CALC:EVM:LIM:TOFF:STAT ON CALC:EVM:LIM:TOFF:STAT?
Notes	LIMit1 is for BS, 2 for MS. Default is BS.
Preset	1e-6 ON
State Saved	Saved in instrument state.

Min	0
Max	100e-3
Initial S/W Revision	Prior to A.02.00

### I/Q Offset

Sets the limit state for the I/Q Offset measurement pass/fail test.

Key Path	Meas Setup, Limits
Mode	WIMAXOFDMA
Remote Command	:CALCulate:EVM:LIMit[1] 2:IQOffset <rel_amp1> :CALCulate:EVM:LIMit[1] 2:IQOffset? :CALCulate:EVM:LIMit[1] 2:IQOffset:STATE OFF ON 0 1 :CALCulate:EVM:LIMit[1] 2:IQOffset:STATE?
Example	CALC:EVM:LIM1:IQOF 0 CALC:EVM:LIM1:IQOF? CALC:EVM:LIM:IQOF:STAT OFF CALC:EVM:LIM:IQOF:STAT?
Notes	LIMit1 is for BS, 2 for MS. Default is BS.
Preset	-15 dB ON
State Saved	Saved in instrument state.
Min	-100
Max	0
Initial S/W Revision	Prior to A.02.00

### Abs Spectral Flatness

Accesses a menu that enables you to set absolute spectral flatness measurement setup parameters .

Key Path	Meas Setup, Limits, More
Initial S/W Revision	Prior to A.02.00

### Offset

Selects the offset pairs (upper and lower) that the softkeys affect, and displays the memory selection menu from A to F. The memory selection menu enables you to store up to 5 sets of limit values for the offset pairs, such as Start Subcarrier/ Stop Subcarrier, Upper Mask Start/Upper Mask Stop, and Lower Mask

Start/Lower. Press Offset until the letter of the desired offset (A, B, C, D, E, or F) is underlined. Only one selection at a time is shown on this softkey label.

Key Path	Meas Setup, Limits, More, Abs Spectral Flatness
Mode	WIMAXOFDMA
Preset	A
Range	A B C D E F
Initial S/W Revision	Prior to A.02.00

### Start Subcarrier

Specifies the start subcarrier for the currently selected offset.

Key Path	Meas Setup, Limits, More, Abs Spectral Flatness
Mode	WIMAXOFDMA
<b>Remote Command</b>	<pre>:CALCulate:EVM:LIMit[1]  2:SPECTrum:AMPFlatness:ABS:OFFSet:LIST:SUBCarrier:START &lt;integer&gt;, &lt;integer&gt;, &lt;integer&gt;, &lt;integer&gt;, &lt;integer&gt;, &lt;integer&gt;  :CALCulate:EVM:LIMit[1]  2:SPECTrum:AMPFlatness:ABS:OFFSet:LIST:SUBCarrier:START?  :CALCulate:EVM:LIMit[1]  2:SPECTrum:AMPFlatness:ABS:OFFSet:LIST:SUBCarrier:STATE ON   OFF   1   0, ON   OFF   1   0, ON   OFF   1   0, ON   OFF   1   0, ON   OFF   1   0, ON   OFF   1   0  :CALCulate:EVM:LIMit[1]  2:SPECTrum:AMPFlatness:ABS:OFFSet:LIST:SUBCarrier:STATE?</pre>
<b>Example</b>	<pre>CALC:EVM:LIM:SPEC:AMPF:ABS:OFFS:LIST:SUBC:STAR 1, 210, 0, 0, 0, 0 CALC:EVM:LIM:SPEC:AMPF:ABS:OFFS:LIST:SUBC:STAR? CALC:EVM:LIM:SPEC:AMPF:ABS:OFFS:LIST:SUBC:STAT ON, ON, ON, OFF, OFF, OFF CALC:EVM:LIM:SPEC:AMPF:ABS:OFFS:LIST:SUBC:STAT?</pre>
<b>Notes</b>	<p>On/Off (:CALCulate:EVM:LIMit[1] 2:SPECTrum:AMPFlatness:ABS:OFFSet:LIST:SUBCarrier:STATE) determines whether or not the designated offsets are available for the limit test. For example, :CALCulate:EVM:LIMit[1] 2:SPECTrum:AMPFlatness:ABS:OFFSet:LIST:SUBCarrier:STATE 1,0,0,0,0,0 means that only the first offset's limit test is available.</p> <p>See the following table for the default values for each Radio Standard.</p> <p>Comma separated list of 6 values. LIMit1 is for BS, 2 for MS. Default is BS.</p>
<b>Couplings</b>	<p>(1)Coupled to Stop Subcarrier. Start Subcarrier should be less than or equal to Stop Subcarrier.</p> <p>(2)Affected by Radio Device, FFT Size (See the Mode Setup section), and the permutation type of the selected zone as follows:</p> <pre>Downlink FFT 2048, PUSC :0, 1, 420, 0, 0, 0 Downlink FFT 1024, PUSC (default): 0, 1, 210, 0, 0, 0 Downlink FFT 512, PUSC :0, 1, 105, 0, 0, 0 Downlink FFT 128, PUSC : 0, 1, 21, 0, 0, 0 Downlink FFT 2048, FUSC :0, 1, 426, 0, 0, 0</pre>

---

Downlink FFT 1024, FUSC : 0, 1, 213, 0, 0, 0  
 Downlink FFT 512, FUSC : 0, 1, 107, 0, 0, 0  
 Downlink FFT 128, FUSC : 0, 1, 26, 0, 0, 0  
 Downlink FFT 2048, OFUSC : 0, 1, 432, 0, 0, 0  
 Downlink FFT 1024, OFUSC : 0, 1, 216, 0, 0, 0  
 Downlink FFT 512, OFUSC : 0, 1, 108, 0, 0, 0  
 Downlink FFT 128, OFUSC : 0, 1, 27, 0, 0, 0  
 Downlink FFT 2048, AMC : 0, 1, 432, 0, 0, 0  
 Downlink FFT 1024, AMC : 0, 1, 216, 0, 0, 0  
 Downlink FFT 512, AMC : 0, 1, 108, 0, 0, 0  
 Downlink FFT 128, AMC : 0, 1, 27, 0, 0, 0  
 Uplink FFT 2048, PUSC : 0, 1, 420, 0, 0, 0  
 Uplink FFT 1024, PUSC (default): 0, 1, 210, 0, 0, 0  
 Uplink FFT 512, PUSC : 0, 1, 102, 0, 0, 0  
 Uplink FFT 128, PUSC : 0, 1, 24, 0, 0, 0  
 Uplink FFT 2048, OPUSC : 0, 1, 432, 0, 0, 0  
 Uplink FFT 1024, OPUSC : 0, 1, 216, 0, 0, 0  
 Uplink FFT 512, OPUSC : 0, 1, 108, 0, 0, 0  
 Uplink FFT 128, OPUSC : 0, 1, 27, 0, 0, 0

---

Preset	1, 210, 0, 0, 0, 0 1,1,0,0,0,0
--------	-----------------------------------

---

State Saved	Saved in instrument state.
-------------	----------------------------

---

Min	-1024
-----	-------

---

Max	1024
-----	------

---

Initial S/W Revision	Prior to A.02.00
----------------------	------------------

---

## Stop Subcarrier

Specifies the stop subcarrier for the currently selected offset.

---

Key Path	Meas Setup, Limits, More, Abs Spectral Flatness
----------	-------------------------------------------------

---

Mode	WIMAXOFDMA
------	------------

---

<b>Remote Command</b>	:CALCulate:EVM:LIMit[1]  2:SPECTrum:AMPFlatness:ABS:OFFSet:LIST:SUBCarrier:STOP <integer>, <integer>, <integer>, <integer>, <integer>, <integer>,  :CALCulate:EVM:LIMit[1]  2:SPECTrum:AMPFlatness:ABS:OFFSet:LIST:SUBCarrier:STOP?
-----------------------	----------------------------------------------------------------------------------------------------------------------------------------------------------------------------------------------------------------------------------------------------

---

<b>Example</b>	CALC:EVM:LIM:SPEC:AMPF:ABS:OFFS:LIST:SUBC:STOP 210, 420, 0, 0, 0, 0 CALC:EVM:LIM:SPEC:AMPF:ABS:OFFS:LIST:SUBC:STOP?
----------------	------------------------------------------------------------------------------------------------------------------------

---

Notes	See the following table for the default values for each Radio Standard.
-------	-------------------------------------------------------------------------

---

	Comma separated list of 6 values. LIMit1 is for BS, 2 for MS. Default is BS.
Couplings	<p>(1)Coupled to Start Subcarrier. Stop Subcarrier should be greater than or equal to Start Subcarrier.  (2)Affected by Radio Device, FFT Size (See the Mode Setup section), and the permutation type of the selected zone as follows:</p> <p>Downlink FFT 2048, PUSC :0, 420, 840, 0, 0, 0  Downlink FFT 1024, PUSC (default): 0, 210, 420, 0, 0, 0  Downlink FFT 512, PUSC :0, 105, 210, 0, 0, 0  Downlink FFT 128, PUSC : 0, 21, 42, 0, 0, 0  Downlink FFT 2048, FUSC :0, 426, 851, 0, 0, 0  Downlink FFT 1024, FUSC : 0, 213, 425, 0, 0, 0  Downlink FFT 512, FUSC : 0, 107, 213, 0, 0, 0  Downlink FFT 128, FUSC : 0, 26, 53, 0, 0, 0  Downlink FFT 2048, OFUSC : 0, 432, 864, 0, 0, 0  Downlink FFT 1024, OFUSC : 0, 216, 432, 0, 0, 0  Downlink FFT 512, OFUSC : 0, 108, 216, 0, 0, 0  Downlink FFT 128, OFUSC : 0, 27, 54, 0, 0, 0  Downlink FFT 2048, AMC :0, 432, 864, 0, 0, 0  Downlink FFT 1024, AMC : 0, 216, 432, 0, 0, 0  Downlink FFT 512, AMC : 0, 108, 216, 0, 0, 0  Downlink FFT 128, AMC : 0, 27, 54, 0, 0, 0  Uplink FFT 2048, PUSC :0, 420, 840, 0, 0, 0  Uplink FFT 1024, PUSC (default): 0, 210, 420, 0, 0, 0  Uplink FFT 512, PUSC :0, 102, 205, 0, 0, 0  Uplink FFT 128, PUSC : 0, 24, 48, 0, 0, 0  Uplink FFT 2048, OPUSC :0, 432, 864, 0, 0, 0  Uplink FFT 1024, OPUSC : 0, 216, 432, 0, 0, 0  Uplink FFT 512, OPUSC :0, 108, 216, 0, 0, 0  Uplink FFT 128, OPUSC : 0, 27, 54, 0, 0, 0</p>
Preset	210,420,0,0,0,0
State Saved	Saved in instrument state.
Min	-1024
Max	1024
Initial S/W Revision	Prior to A.02.00

### Offset Side

Specifies which offset side will be measured.

Key Path	Meas Setup, Limits, More, Abs Spectral Flatness
----------	-------------------------------------------------

Mode	WIMAXOFDMA
Remote Command	:CALCulate:EVM:LIMit[1] 2:SPECTrum:AMPFlatness:ABS:OFFSet:LIST:SIDE BOTH   NEGative   POSitive, BOTH   NEGative   POSitive, BOTH   NEGative   POSitive, BOTH   NEGative   POSitive, BOTH   NEGative   POSitive, BOTH   NEGative   POSitive  :CALCulate:EVM:LIMit[1] 2:SPECTrum:AMPFlatness:ABS:OFFSet:LIST:SIDE?
Example	CALC:EVM:LIM:SPEC:AMPF:ABS:OFFS:LIST:SIDE BOTH, BOTH, BOTH, BOTH, BOTH, BOTH CALC:EVM:LIM:SPEC:AMPF:ABS:OFFS:LIST:SIDE?
Notes	LIMit1 is for BS, 2 for MS. Default is BS.
Preset	BOTH, BOTH, BOTH, BOTH, BOTH, BOTH BOTH, BOTH, BOTH, BOTH, BOTH, BOTH
State Saved	Saved in instrument state.
Range	Neg Both Pos
Initial S/W Revision	Prior to A.02.00

### Upper Mask Start

Sets the upper limit level at the start subcarrier for the selected offset.

Key Path	Meas Setup, Limits, More, Abs Spectral Flatness, More
Mode	WIMAXOFDMA
Remote Command	:CALCulate:EVM:LIMit[1]  2:SPECTrum:AMPFlatness:ABS:OFFSet:LIST:UPPer:STARt <real>, <real>, <real>, <real><real><real>  :CALCulate:EVM:LIMit[1]  2:SPECTrum:AMPFlatness:ABS:OFFSet:LIST:UPPer:STARt?  :CALCulate:EVM:LIMit[1]  2:SPECTrum:AMPFlatness:ABS:OFFSet:LIST:UPPer:STATe ON   OFF   1   0, ON   OFF   1   0, ON   OFF   1   0, ON   OFF   1   0, ON   OFF   1   0, ON   OFF   1   0  :CALCulate:EVM:LIMit[1]  2:SPECTrum:AMPFlatness:ABS:OFFSet:LIST:UPPer:STATe?
Example	CALC:EVM:LIM:SPEC:AMPF:ABS:OFFS:LIST:UPP:STAR 2, 2, 0, 0, 0, 0 CALC:EVM:LIM:SPEC:AMPF:ABS:OFFS:LIST:UPP:STAR? CALC:EVM:LIM:SPEC:AMPF:ABS:OFFS:LIST:UPP:STATe 0, 0, 0, 0, 0, 0 CALC:EVM:LIM:SPEC:AMPF:ABS:OFFS:LIST:UPP:STATe?
Notes	On/Off (:CALCulate:EVM:LIMit[1] 2:SPECTrum:AMPFlatness:ABS:OFFSet:LIST:UPPer:STATe) determines whether or not the designated offsets are available for the upper mask limit test. For example, :CALCulate:EVM:LIMit[1] 2:SPECTrum:AMPFlatness:ABS:OFFSet:LIST:UPPer:STATe 1,0,0,0,0,0 means that only the first offset's upper mask test is available. See the following table for the default values for each Radio Standard. Comma separated list of 6 values. LIMit1 is for BS, 2 for MS. Default is BS.
Preset	2,2,0,0,0,0 1,1,0,0,0,0

State Saved	Saved in instrument state.
Min	-100 dB
Max	100 dB
Initial S/W Revision	Prior to A.02.00

### Upper Mask Stop

Sets the upper mask limit at the stop subcarrier for the selected offset. The upper mask limit ranges from -100 to +100 dB. You can also toggle this function between Auto and Man settings. If set to Auto, the Upper Mask Stop power level limit is coupled to Upper Mask Start, and results in a flat limit line. If set to Man, Upper Mask Start and Upper Mask Stop take different values and result in a sloped limit line.

Key Path	Meas Setup, Limits, More, Abs Spectral Flatness, More
Mode	WIMAXOFDMA
Remote Command	<pre>:CALCulate:EVM:LIMit[1]  2:SPECTrum:AMPFlatness:ABS:OFFSet:LIST:UPPer:STOP &lt;real&gt;, &lt;real&gt;, &lt;real&gt;, &lt;real&gt;, &lt;real&gt;, &lt;real&gt;  :CALCulate:EVM:LIMit[1]  2:SPECTrum:AMPFlatness:ABS:OFFSet:LIST:UPPer:STOP?  :CALCulate:EVM:LIMit[1]  2:SPECTrum:AMPFlatness:ABS:OFFSet:LIST:UPPer:STOP:AUTO MANual   AUTO, MANual   AUTO, MANual   AUTO, MANual   AUTO, MANual   AUTO, MANual   AUTO  :CALCulate:EVM:LIMit[1]  2:SPECTrum:AMPFlatness:ABS:OFFSet:LIST:UPPer:STOP:AUTO?</pre>
Example	<pre>CALC:EVM:LIM:SPEC:AMPF:ABS:OFFS:LIST:UPP:STOP -15, 2, 2, 0, 0, 0 CALC:EVM:LIM:SPEC:AMPF:ABS:OFFS:LIST:UPP:STOP? CALC:EVM:LIM:SPEC:AMPF:ABS:OFFS:LIST:UPP:STOP:AUTO AUTO, AUTO, AUTO, AUTO, AUTO, AUTO CALC:EVM:LIM:SPEC:AMPF:ABS:OFFS:LIST:UPP:STOP:AUTO?</pre>
Notes	<p>See the following table for the default values for each Radio Standard. Comma separated list of 6 values. LIMit1 is for BS, 2 for MS. Default is BS.</p>
Couplings	When coupling is set to Auto, the value will be the same as Upper Mask Start.
Preset	2,2,0,0,0,0 AUTO,AUTO,AUTO,AUTO,AUTO,AUTO
State Saved	Saved in instrument state.
Min	-100 dB
Max	100 dB
Initial S/W Revision	Prior to A.02.00

### Lower Mask Start

Sets the upper limit level at the start subcarrier for the selected offset.

<b>Key Path</b>	Meas Setup, Limits, More, Abs Spectral Flatness, More
<b>Mode</b>	WIMAXOFDMA
<b>Remote Command</b>	<pre>:CALCulate:EVM:LIMit[1]  2:SPECTrum:AMPFlatness:ABS:OFFSet:LIST:LOWer:STARt &lt;real&gt;, &lt;real&gt;, &lt;real&gt;, &lt;real&gt;, &lt;real&gt;, &lt;real&gt;  :CALCulate:EVM:LIMit[1]  2:SPECTrum:AMPFlatness:ABS:OFFSet:LIST:LOWer:STARt?  :CALCulate:EVM:LIMit[1]  2:SPECTrum:AMPFlatness:ABS:OFFSet:LIST:LOWer:STATe ON   OFF   1   0, ON   OFF   1   0, ON   OFF   1   0, ON   OFF   1   0, ON   OFF   1   0, ON   OFF   1   0  :CALCulate:EVM:LIMit[1]  2:SPECTrum:AMPFlatness:ABS:OFFSet:LIST:LOWer:STATe?</pre>
<b>Example</b>	<pre>CALC:EVM:LIM:SPEC:AMPF:ABS:OFFS:LIST:LOW:STAR -2, -4, 0, 0, 0, 0 CALC:EVM:LIM:SPEC:AMPF:ABS:OFFS:LIST:LOW:STAR? CALC:EVM:LIM:SPEC:AMPF:ABS:OFFS:LIST:LOW:STATe 1, 1, 0, 0, 0, 0 CALC:EVM:LIM:SPEC:AMPF:ABS:OFFS:LIST:LOW:STATe?</pre>
<b>Notes</b>	<p>On/Off (:CALCulate:EVM:LIMit[1] 2:SPECTrum:AMPFlatness:ABS:OFFSet:LIST:LOWer:STATe) determines whether or not the designated offsets are available for the lower mask limit test. For example, :CALCulate:EVM:LIMit[1] 2:SPECTrum:AMPFlatness:ABS:OFFSet:LIST:LOWer:STATe 1,0,0,0,0,0 means that only the first offset's lower mask test is available.</p> <p>See the following table for the default values for each Radio Standard.</p> <p>Comma separated list of 6 values. LIMit1 is for BS, 2 for MS. Default is BS.</p>
<b>Preset</b>	<pre>-2,-4,0,0,0,0 1,1,0,0,0,0</pre>
<b>State Saved</b>	Saved in instrument state.
<b>Min</b>	-100 dB
<b>Max</b>	100 dB
<b>Initial S/W Revision</b>	Prior to A.02.00

### Lower Mask Stop

Sets the lower mask limit at the stop subcarrier for the selected offset. The upper mask limit ranges from – 100 to +100 dB. You can also toggle this function between Auto and Man settings. If set to Auto, the Upper Mask Stop power level limit is coupled to Upper Mask Start, which results in a flat limit line. If set to Man, Upper Mask Start and Upper Mask Stop take different values and result in a sloped limit line.

<b>Key Path</b>	Meas Setup, Limits, More, Abs Spectral Flatness, More
<b>Mode</b>	WIMAXOFDMA
<b>Remote Command</b>	:CALCulate:EVM:LIMit[1]



```
|2:SPECTrum:AMPFlatness:ABS:OFFSet:LIST:LOWer:STOP <real>, <real>,
<real>, <real>, <real>, <real>

:CALCulate:EVM:LIMit[1]
|2:SPECTrum:AMPFlatness:ABS:OFFSet:LIST:LOWer:STOP?

:CALCulate:EVM:LIMit[1]
|2:SPECTrum:AMPFlatness:ABS:OFFSet:LIST:LOWer:STOP:AUTO MANual | AUTO,
MANual | AUTO, MANual | AUTO, MANual | AUTO, MANual | AUTO, MANual |
AUTO

:CALCulate:EVM:LIMit[1]
|2:SPECTrum:AMPFlatness:ABS:OFFSet:LIST:LOWer:STOP:AUTO?
```

<b>Example</b>	<p>CALC:EVM:LIM:SPEC:AMPF:ABS:OFFS:LIST:LOW:STOP -2, -4, 0, 0, 0, 0</p> <p>CALC:EVM:LIM:SPEC:AMPF:ABS:OFFS:LIST:LOW:STOP?</p> <p>CALC:EVM:LIM:SPEC:AMPF:ABS:OFFS:LIST:LOW:STOP:AUTO AUTO, AUTO, AUTO, AUTO, AUTO, AUTO</p> <p>CALC:EVM:LIM:SPEC:AMPF:ABS:OFFS:LIST:LOW:STOP:AUTO?</p>
Notes	<p>See the following table for the default values for each Radio Standard.</p> <p>Comma separated list of 6 values. LIMit1 is for BS, 2 for MS. Default is BS.</p>
Couplings	When coupling is set to Auto, the value will be the same as Lower Mask Start.
Preset	-2,-4,0,0,0,0 AUTO,AUTO,AUTO,AUTO,AUTO,AUTO
State Saved	Saved in instrument state.
Min	-100 dB
Max	100 dB
Initial S/W Revision	Prior to A.02.00

## Zone/Data Burst Map

Selects the Zone Definition which defines the zone information.

Key Path	Meas Setup, More
<b>Remote Command</b>	:CALCulate:EVM:MAP:SElect:TYPE AUTO CUSTom FCH :CALCulate:EVM:MAP:SElect:TYPE?
<b>Example</b>	CALC:EVM:MAP:SEL:TYPE AUTO CALC:EVM:MAP:SEL:TYPE?
Preset	CUSTom
State Saved	Saved in instrument state.
Range	Auto Detected Map Custom Map FCH Only
Readback Text	Auto Det Map Custom Map FchOnly
Initial S/W Revision	Prior to A.02.00

## Auto Detect Now

Detects Map information automatically using DL-MAP/UL-MAP and DCD/UCD.

Key Path	Meas Setup, More, Zone Data Burst Map
Mode	WIMAXOFDMA
Remote Command	:CALCulate:EVM:MAP:DETECT
Example	CALC:EVM:MAP:DET
Initial S/W Revision	Prior to A.02.00

## Zone Num

Selects the zone definition to be used.

Key Path	Meas Setup, More
Mode	WIMAXOFDMA
Remote Command	:CALCulate:EVM:ZONE <integer> :CALCulate:EVM:ZONE?
Example	CALC:EVM:ZONE 1 CALC:EVM:ZONE?
Preset	1
State Saved	Saved in instrument state.
Min	1
Max	determined by current map
Initial S/W Revision	Prior to A.02.00

## Data Burst Analysis

Selects a method of burst analysis. You can choose between the burst map method or the single burst method.

Key Path	Meas Setup, More
Remote Command	:CALCulate:EVM:BURSt:TYPE[:SElect] MAP SINGLE UZONE :CALCulate:EVM:BURSt:TYPE[:SElect]?
Example	CALC:EVM:BURS:TYPE MAP CALC:EVM:BURS:TYPE?
Preset	MAP
State Saved	Saved in instrument state.
Range	Burst Map Single Burst (Manual) Uniform Zone (Manual)
Readback Text	Burst Map Single Burst Uniform Zone
Initial S/W Revision	Prior to A.02.00

## Burst Map

Analyzes a frame according to the defined map information.

Key Path	Meas Setup, Data Burst Analysis
Initial S/W Revision	Prior to A.02.00

## Use Defined Boosting Level

Selects whether to automatically set boosting levels, or to use the values that are specified for the bursts.

Key Path	Meas Setup, More, Burst Analysis, Burst Map
Mode	WIMAXOFDMA
<b>Remote Command</b>	:CALCulate:EVM:BURSt:POWer:MAP ON OFF 1 0 :CALCulate:EVM:BURSt:POWer:MAP?
<b>Example</b>	CALC:EVM:BURS:POW:MAP 0 CALC:EVM:BURS:POW:MAP?
Preset	ON
State Saved	Saved in instrument state.
Initial S/W Revision	Prior to A.02.00

## Single Burst

Accesses single burst parameters.

Key Path	Meas Setup, Data Burst Analysis
Initial S/W Revision	Prior to A.02.00

## Subchan Offset

Sets the number of the Subchannel logical offset for the burst region.

Key Path	Meas Setup, More, Burst Analysis, Signal Burst
Mode	WIMAXOFDMA
<b>Remote Command</b>	:CALCulate:EVM:BURSt[1] 2:SUBChannel:OFFSet <integer> :CALCulate:EVM:BURSt[1] 2:SUBChannel:OFFSet?
<b>Example</b>	CALC:EVM:BURS:SUBC:OFFS 1 CALC:EVM:BURS:SUBC:OFFS?
Notes	BURSt1 is for BS, 2 for MS. Default is BS.

Preset	0
State Saved	Saved in instrument state.
Min	0
Max	Number of subchannels on current zone - 1
Initial S/W Revision	Prior to A.02.00

### Burst Region Subchannel Interval

Sets the number of the subchannel logical interval for the burst region.

Key Path	Meas Setup, More, Burst Analysis, Signal Burst
Mode	WIMAXOFDMA
Remote Command	:CALCulate:EVM:BURSt[1] 2:SUBChannel:INTerval <integer> :CALCulate:EVM:BURSt[1] 2:SUBChannel:INTerval?
Example	CALC:EVM:BURS:SUBC:INT 1 CALC:EVM:BURS:SUBC:INT?
Notes	BURSt1 is for BS, 2 for MS. Default is BS.
Preset	1
State Saved	Saved in instrument state.
Min	1
Max	Number of subchannels on current zone - Burst Region Subchannel Offset
Initial S/W Revision	Prior to A.02.00

### Symbol Offset

Sets the number of the OFDMA symbol offset for the burst region.

Key Path	Meas Setup, More, Burst Analysis, Signal Burst
Mode	WIMAXOFDMA
Remote Command	:CALCulate:EVM:BURSt[1] 2:SYMBOL:OFFSet <integer> :CALCulate:EVM:BURSt[1] 2:SYMBOL:OFFSet?
Example	CALC:EVM:BURS:SYMB:OFFS 1 CALC:EVM:BURS:SYMB:OFFS?
Notes	BURSt1 is for BS, 2 for MS. Default is BS.
Preset	0
State Saved	Saved in instrument state.
Min	0
Max	500
Initial S/W Revision	Prior to A.02.00

## Symbol Interval

Sets the number of the OFDMA symbol interval for the burst position.

Key Path	Meas Setup, More, Burst Analysis, Signal Burst
Mode	WIMAXOFDMA
Remote Command	:CALCulate:EVM:BURSt[1] 2:SYMBol:INTerval <integer> :CALCulate:EVM:BURSt[1] 2:SYMBol:INTerval?
Example	CALC:EVM:BURS:SYMB:INT 1 CALC:EVM:BURS:SYMB:INT?
Notes	BURSt1 is for BS, 2 for MS. Default is BS.
Preset	1
State Saved	Saved in instrument state.
Min	1
Max	15 – Burst Region Symbol Offset
Initial S/W Revision	Prior to A.02.00

## Burst Shape

Selects between wrapped or rectangle burst shapes.

Key Path	Meas Setup, More, Burst Analysis, Signal Burst
Remote Command	:CALCulate:EVM:BURSt[1] 2:SHAPE WRAPped RECTangle :CALCulate:EVM:BURSt[1] 2:SHAPE?
Example	CALC:EVM:BURS:SHAP WRAP CALC:EVM:BURS:SHAP?
Notes	BURSt1 is for BS, 2 for MS. Default is BS.
Preset	RECTangle
State Saved	Saved in instrument state.
Range	Wrapped Rectangle
Readback Text	WRAP RECT
Initial S/W Revision	Prior to A.02.00

## Data Mod Type

Selects the Data Modulation Type to be used.

Key Path	Meas Setup, More, Burst Analysis, Signal Burst
Remote Command	:CALCulate:EVM:BURSt[1] 2:MODulation:TYPE QPSKR1BY2   QPSKR3BY4

	QAM16R1BY2   QAM16R3BY4   QAM64R1BY2   QAM64R2BY3   QAM64R3BY4 :CALCulate:EVM:BURSt[1] 2:MODulation:TYPE?
<b>Example</b>	CALC:EVM:BURS:MOD:TYPE QPSKR1BY2 CALC:EVM:BURS:MOD:TYPE?
Notes	BURSt1 is for BS, 2 for MS. Default is BS.
Preset	QPSKR1BY2
State Saved	Saved in instrument state.
Range	QPSK-1/2 QPSK-3/4 16QAM-1/2 16QAM-3/4 64QAM-1/2 64QAM-2/3 64QAM-3/4
Readback Text	QPSK-1/2 QPSK-3/4 16QAM-1/2 16QAM-3/4 64QAM-1/2 64QAM-2/3 64QAM-3/4
Initial S/W Revision	Prior to A.02.00

## Uniform Zone

Defines a single burst as a Uniform Zone.

Key Path	Meas Setup, Data Burst Analysis
Initial S/W Revision	Prior to A.02.00

## Data Mod Type

Selects the Data Modulation Type to be used.

Key Path	Meas Setup, More, Burst Analysis, Uniform Zone
<b>Remote Command</b>	:CALCulate:EVM:UZONe[1] 2:MODulation:TYPE QPSKR1BY2   QPSKR3BY4   QAM16R1BY2   QAM16R3BY4   QAM64R1BY2   QAM64R2BY3   QAM64R3BY4 :CALCulate:EVM:UZONe[1] 2:MODulation:TYPE?
<b>Example</b>	CALC:EVM:UZON:MOD:TYPE QAM64R3BY4 CALC:EVM:UZON:MOD:TYPE?
Notes	UZONe1 is for BS, 2 for MS. Default is BS.
Preset	QPSKR1BY2
State Saved	Saved in instrument state.
Range	QPSK-1/2 QPSK-3/4 16QAM-1/2 16QAM-3/4 64QAM-1/2 64QAM-2/3 64QAM-3/4
Readback Text	QPSK-1/2 QPSK-3/4 16QAM-1/2 16QAM-3/4 64QAM-1/2 64QAM-2/3 64QAM-3/4
Initial S/W Revision	Prior to A.02.00

## Zone Offset

Sets the Zone Offset in symbols.

Key Path	Meas Setup, More
Mode	WIMAXOFDMA
<b>Remote Command</b>	:CALCulate:EVM:ZONE:OFFSet <integer> :CALCulate:EVM:ZONE:OFFSet?
<b>Example</b>	CALC:EVM:ZONE:OFFS 2 CALC:EVM:ZONE:OFFS?
Dependencies	Grayed out when Burst Map is selected in Burst Analysis.
Preset	1
State Saved	Saved in instrument state.
Min	0
Max	determined by current map
Initial S/W Revision	Prior to A.02.00

## Zone Interval

Sets Zone Interval in symbols.

Key Path	Meas Setup, More
Mode	WIMAXOFDMA
<b>Remote Command</b>	:CALCulate:EVM:ZONE:INTerval <integer> :CALCulate:EVM:ZONE:INTerval?
<b>Example</b>	CALC:EVM:ZONE:INT 12 CALC:EVM:ZONE:INT?
Dependencies	Grayed out when Burst Map is selected in Burst Analysis.
Preset	2
State Saved	Saved in instrument state.
Min	1
Max	determined by current map
Initial S/W Revision	Prior to A.02.00

## Data Burst Select

The analyzer enables single or multiple burst analysis. To select all data burst for analysis, press 'All On' key. To select a single data burst for analysis, press 'Single' key on a selected Data Burst Num. To select multiple data bursts for analysis, turn on a selected Data Burst Num.

Key Path	Meas Setup, Data Burst Select
Initial S/W Revision	Prior to A.02.00

## Data Burst Num

Selects multiple data bursts for analysis when it is set to On.

Key Path	Meas Setup, More, Data Burst Select
Mode	WIMAXOFDMA
Remote Command	:CALCulate:EVM:BURSt:STATe ON OFF 1 0, ... :CALCulate:EVM:BURSt:STATe?
Example	CALC:EVM:BURS:STAT 0,0 CALC:EVM:BURS:STAT?
Notes	Number of elements is determined by Number of Bursts provided by :CALC:EVM:BURS:NUMB?. See <a href="#">Number of Bursts (Query Only)</a> .
Preset	1
State Saved	Saved in instrument state.
Range	On Off
Initial S/W Revision	Prior to A.02.00

## All On

Selects all data burst for analysis.

Key Path	Meas Setup, More, Data Burst Select
Mode	WIMAXOFDMA
Notes	Number of elements is determined by Number of Bursts provided by :CALC:EVM:BURS:NUMB?. See <a href="#">Number of Bursts (Query Only)</a> .
Initial S/W Revision	Prior to A.02.00

## Single

Selects a single data burst for analysis.

Key Path	Meas Setup, More, Data Burst Select
Mode	WIMAXOFDMA
Notes	Number of elements is determined by Number of Bursts provided by :CALC:EVM:BURS:NUMB?. See <a href="#">Number of Bursts (Query Only)</a> .
Initial S/W Revision	Prior to A.02.00

## Preamble Index

Sets the number that the Preamble Index specifies for the preamble sequence of the downlink subframe.



Key Path	Meas Setup, More, More
Mode	WIMAXOFDMA
<b>Remote Command</b>	:CALCulate:EVM:PINdex <integer> :CALCulate:EVM:PINdex?
<b>Example</b>	CALC:EVM:PIND 1 CALC:EVM:PIND?
Notes	This parameter is available only in BS mode.
Preset	0
State Saved	Saved in instrument state.
Min	0
Max	113
Initial S/W Revision	Prior to A.02.00

### Subchannel Group Bitmask

Specifies which subchannel groups are allocated to the segment. The DL PUSC zone definition provides 6 subchannel groups which specify the number of used subchannels and how they are mapped to subcarriers for analysis of DL-PUSC data bursts.

Key Path	Meas Setup, More, More
<b>Remote Command</b>	:CALCulate:EVM:SUBChannel:MASK OFF ON 0 1, ... :CALCulate:EVM:SUBChannel:MASK?
<b>Example</b>	CALC:EVM:SUBC:MASK 1,1,1,1,1,1 CALC:EVM:SUBC:MASK?
Notes	This parameter is available only in BS mode. This parameter depends on Preamble Index parameter (1.6.6.13) When On PreambleIndex = 0, 1, ..., 31, 96, 99, 102, 105, 108 and 111 (Segment #0), Group #0 should be ALWAYS ON. When On PreambleIndex = 32, 33, ..., 63, 97, 100, 103, 106, 109 and 112 (Segment #1), Group #2 should be ALWAYS ON. When On PreambleIndex = 64, 65, ..., 95, 98, 101, 104, 107, 110 and 113 (Segment #2), Group #4 should be ALWAYS ON.
Preset	1, 1, 1, 1, 1, 1
State Saved	Saved in instrument state.
Initial S/W Revision	Prior to A.02.00

### Meas Preset

Restores all the measurement parameters to their default values.

Key Path	Meas Setup, More, More
Mode	WIMAXOFDMA
Remote Command	:CONFigure:EVM
Example	CONF:EVM
Initial S/W Revision	Prior to A.02.00

## Advanced

Accesses advanced features. These features are recommended for use only by advanced users.

Key Path	Meas Setup, More
Initial S/W Revision	Prior to A.02.00

## Pilot in RMS/Pk RCE

Includes or excludes the Pilot in RCE calculations.

Key Path	Meas Setup, More, More, Advanced
Mode	WIMAXOFDMA
Remote Command	:CALCulate:EVM:PILot INCLude EXCLude :CALCulate:EVM:PILot?
Example	CALC:EVM:PIL INCL CALC:EVM:PIL?
Preset	EXCLude
State Saved	Saved in instrument state.
Range	INCLude EXCLude
Initial S/W Revision	Prior to A.02.00

## Spectrum

Sets a spectrum to either normal or to inverted for demodulation related measurements. If set to INVert, the upper and lower spectrums are swapped.

The invert function conjugates the spectrum, which is equivalent to taking the negative of the quadrature component in demodulation. The correct setting (Normal or Invert) depends on whether the signal at the input of the instrument has a high or a low side mix.

Key Path	Meas Setup, More, More, Advanced
Mode	WIMAXOFDMA
Remote Command	:CALCulate:EVM:SPECTrum INVert NORMal

	:CALCulate:EVM:SPECTrum?
<b>Example</b>	CALC:EVM:SPEC INV CALC:EVM:SPEC?
Preset	NORMal
State Saved	Saved in instrument state.
Range	Normal Invert
Initial S/W Revision	Prior to A.02.00

## Symbol Timing Adjust

Symbol Timing Adjust enables you to adjust the "useful symbol time period" (TFFT) within the "OFDMA extended symbol time period" (TS). Symbol Timing Adjust shifts the start of the TFFT period to earlier in the TS time period. You specify the amount of TFFT shift as a percentage of the TFFT length.

The extended OFDMA symbol time period (TS) consists of a guard interval (TGI) plus a "useful symbol time period" (T

FFT). Within the TS, the analyzer performs the demodulation and data analysis on only one TFFT time period. The Symbol Time Adjust parameter enables you to move the TFFT within the TS.

Typically, the TGI time period is ignored and only the TFFT time period is used. The Symbol Time Adjust parameter causes the demodulation start time to begin earlier within each extended symbol time. The minimum Symbol Time Adjust value is equal to  $-(\text{guard interval})/100$ , the maximum value is "0" (full guard interval).

The Symbol Time Adjust parameter is reset to the default value whenever the Guard Interval is changed. The default value is  $-3.125\%$ , if the guard interval is  $1/16$  or greater. The default value is equal to  $\text{TGI} \cdot 100/2$  (half the guard interval) when the guard interval is less than  $1/16$ .

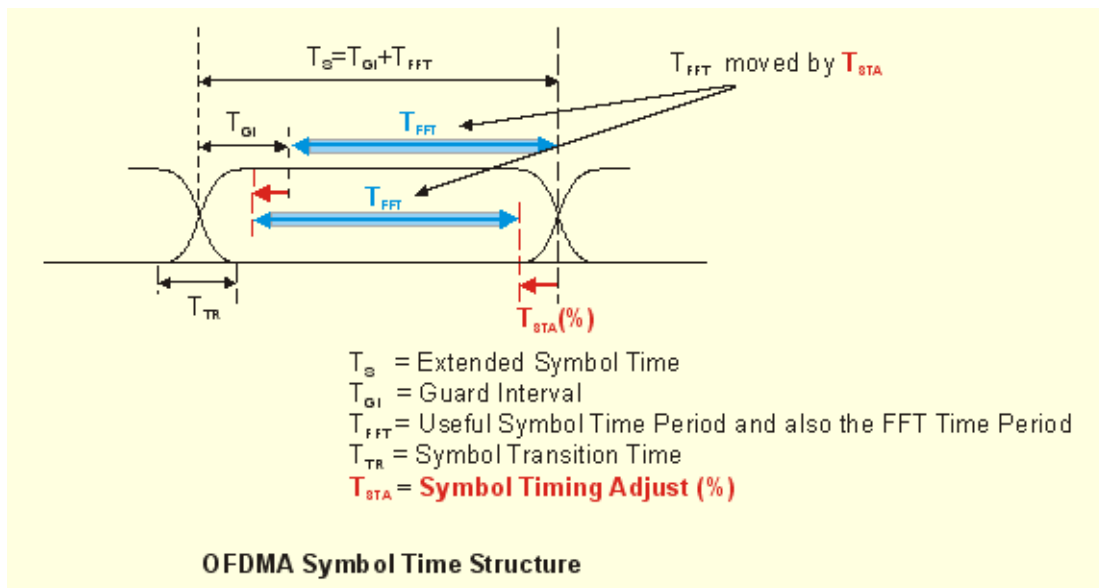

<b>Key Path</b>	Meas Setup, More, More, Advanced
<b>Remote Command</b>	:CALCulate:EVM:SYMBOL:ADJust <real> :CALCulate:EVM:SYMBOL:ADJust?
<b>Example</b>	CALC:EVM:SYMB:ADJ -3.125 CALC:EVM:SYMB:ADJ?
<b>Preset</b>	-3.125%
<b>State Saved</b>	Saved in instrument state.
<b>Range</b>	-12.5 % to - 0 %
<b>Min</b>	-12.5 %
<b>Max</b>	0 %
<b>Initial S/W Revision</b>	Prior to A.02.00

## Pilot Tracking

802.16 OFDMA performs demodulation relative to the data in pilot carriers embedded in the signal. These pilot carriers replace data-carrying elements of the signal and allow some kinds of impairments to be removed or "tracked out".

Many impairments will be common to all pilot carriers and can be measured and displayed as "common pilot error".

In addition, several specific tracking functions can be individually switched on and off in the demodulation performed by this measurement. This is a very useful troubleshooting approach, since modulation errors can be examined with and without the benefit of particular types of pilot tracking.

<b>Key Path</b>	Meas Setup, Advanced
<b>Initial S/W Revision</b>	Prior to A.02.00

## Track Amplitude

Track Amplitude specifies whether the analyzer tracks amplitude changes in the pilot subcarriers. When Track Amplitude is selected, the analyzer applies pilot subcarrier amplitude error correction to the pilot and data subcarriers. This is in addition to Track Phase and Track Timing error correction, if selected.

<b>Key Path</b>	Meas Setup, More, More, Advanced, Pilot Tracking
<b>Mode</b>	WIMAXOFDMA
<b>Remote Command</b>	:CALCulate:EVM:PILOT:TRACk:AMPLitude OFF ON 0 1 :CALCulate:EVM:PILOT:TRACk:AMPLitude?
<b>Example</b>	CALC:EVM:PIL:TRAC:AMPL 1 CALC:EVM:PIL:TRAC:AMPL?
<b>Preset</b>	OFF

State Saved	Saved in instrument state.
Range	On Off
Initial S/W Revision	Prior to A.02.00

### Track Phase

The Track Phase parameter specifies whether the analyzer tracks phase changes in the pilot subcarriers. When Track Phase is selected, the analyzer applies pilot subcarrier phase error correction to the pilot and data subcarriers. This is in addition to Track Amplitude and Track Timing error correction if selected.

Key Path	Meas Setup, More, More, Advanced, Pilot Tracking
Mode	WIMAXOFDMA
<b>Remote Command</b>	:CALCulate:EVM:PILot:TRACk:PHASe OFF ON 0 1 :CALCulate:EVM:PILot:TRACk:PHASe?
<b>Example</b>	CALC:EVM:PIL:TRAC:PHAS 0 CALC:EVM:PIL:TRAC:PHAS?
Preset	ON
State Saved	Saved in instrument state.
Range	On Off
Initial S/W Revision	Prior to A.02.00

### Track Timing

The Track Timing parameter specifies whether the analyzer tracks timing changes in the pilot subcarriers. When Track Timing is selected the analyzer applies pilot subcarrier timing error correction (frequency offset correction) to the pilot and data subcarriers. This is in addition to Track Amplitude and Track Phase error correction if selected.

Key Path	Meas Setup, More, More, Advanced, Pilot Tracking
Mode	WIMAXOFDMA
<b>Remote Command</b>	:CALCulate:EVM:PILot:TRACk:TIMing OFF ON 0 1 :CALCulate:EVM:PILot:TRACk:TIMing?
<b>Example</b>	CALC:EVM:PIL:TRAC:TIM 1 CALC:EVM:PIL:TRAC:TIM?
Preset	ON
State Saved	Saved in instrument state.
Range	On Off
Initial S/W Revision	Prior to A.02.00

## Equalizer Training

When demodulating the 802.16 OFDMA signal, the analyzer uses an equalizer to correct for linear impairments in the signal path, such as multi-path. The analyzer supports three different methods to initialize, or "train", the equalizer: Preamble Only, Preamble, Data & Pilots and Preamble & Pilots Only. Selecting an appropriate method can help isolate problems that contribute to increased RCE (EVM).

Key Path	Meas Setup, More, More, Advanced
Remote Command	:CALCulate:EVM:EQUalizer:TMODe SEQuence SDATa SPILot :CALCulate:EVM:EQUalizer:TMODe?
Example	CALC:EVM:EQU:TMOD SDAT CALC:EVM:EQU:TMOD?
Preset	SDATa
State Saved	Saved in instrument state.
Range	BS: Preamble Only Preamble, Data & Pilots Preamble & Pilots MS: No Equalization Data & Pilots Pilots Only
Readback Text	BS: Preamble Pr, Data & Pilots Pr & Pilots MS: No Equalization Data & Pilots Pilots Only
Initial S/W Revision	Prior to A.02.00

## Equalizer Smoothing

This parameter determines whether a spectral flatness result trace is smoothed.

Key Path	Meas Setup, More, More, Advanced
Mode	WIMAXOFDMA
Remote Command	:CALCulate:EVM:EQUalizer:SMOothing:STATe OFF ON 0 1 :CALCulate:EVM:EQUalizer:SMOothing:STATe?
Example	CALC:EVM:EQU:SMO:STAT 1 CALC:EVM:EQU:SMO:STAT?
Preset	OFF
State Saved	Saved in instrument state.
Range	On Off
Initial S/W Revision	Prior to A.02.00

## I/Q Mismatch Compensation

I/Q Mismatch Compensation enables you to remove IQ impairments, including IQ Gain Imbalance, IQ Quadrature Error, and IQ Timing Skew errors, from the EVM and RCE metrics and demodulation measurement results. The I/Q Compensation algorithm uses the measured Gain Imb, Quad Err, and Timing Skew error estimates shown in the Syms/Errs Summary Table. This feature is useful for determining what

the EVM/RCE metric results would be for a DUT in which the IQ mismatch impairments are the dominant factor in EVM/RCE degradation, but could be removed by a later calibration process or redesign.

Key Path	Meas Setup, Advanced
Mode	WIMAXOFDMA
Remote Command	:CALCulate:EVM:IQMismatch:COMPensation OFF ON 0 1 :CALCulate:EVM:IQMismatch:COMPensation?
Example	CALC:EVM:IQM:COMP 1 CALC:EVM:IQM:COMP?
Couplings	When Compensate IQ mismatch is set to ON, Data-and-Pilot method will be used, regardless of the selected Equalizer Training method (See <a href="#">"Equalizer Training" on page 1322</a> <a href="#">"Equalizer Training" on page 1322</a> ).
Preset	OFF
State Saved	Saved in instrument state.
Range	On Off
Initial S/W Revision	A.02.00

## Multi Carrier Filter

This parameter is used to isolate the measurement channel when measuring a multi-carrier signal. The multi-carrier filter suppresses adjacent channel interference from the measurement. Using the multi-carrier filter produces better channel measurement results, such as EVM, but measurement may be slower. Unless the user measures a multi-channel signal, it is recommended to set this parameter OFF.

ON: Include the multi-carrier filter in the measurement.

OFF: Remove the multi-carrier filter from the measurement.

Key Path	Meas Setup, Advanced
Mode	WIMAXOFDMA
Remote Command	:CALCulate:EVM:MCFilter:STATe OFF ON 0 1 :CALCulate:EVM:MCFilter:STATe?
Example	CALC:EVM:MCF:STAT ON CALC:EVM:MCF:STAT?
Preset	OFF
State Saved	Saved in instrument state.
Range	On Off
Initial S/W Revision	A.02.00

11 Modulation Analysis Measurement  
Mode

Mode

See "[Mode](#)" on page 140



## Mode Preset

Returns the active mode to a known state.

Mode Preset does the following for the currently active mode:

- Aborts the currently running measurement.
- Brings up the default menu for the mode, with no active function.
- Sets measurement Global settings to their preset values for the active mode only.
- Activates the default measurement.
- Brings up the default menu for the mode.
- Clears the input and output buffers.
- Sets Status Byte to 0.

Mode Preset does not:

- Cause a mode switch
- Affect mode persistent settings
- Affect system settings
- See "[How-To Preset](#)" on page 1326 for more information.

Key Path	Front-panel key
<b>Remote Command</b>	:SYSTem:PRESet
<b>Example</b>	:SYST:PRES
Notes	*RST is preferred over :SYST:PRES for remote operation. *RST does a Mode Preset, as done by the :SYST:PRES command, and it sets the measurement mode to Single measurement rather than Continuous for optimal remote control throughput. Clears all pending OPC bits. The Status Byte is set to 0.
Couplings	A Mode Preset aborts the currently running measurement, activates the default measurement, and gets the mode to a consistent state with all of the default couplings set.
Backwards Compatibility Notes	In the X-Series, the legacy "Factory Preset" has been replaced with Mode Preset, which only presets the currently active mode, not the entire instrument. In the X-Series, the way to preset the entire instrument is by using System, Restore System Defaults All, which behaves essentially the same way as restore System Defaults does on ESA and PSA. There is also no "Preset Type" as there is on the PSA. There is a green Mode Preset front-panel key that does a Mode Preset and a white-with-green-letters User Preset front-panel key that does a User Preset. The old PRESet:TYPE command is ignored (without generating an error), and SYST:PRES without a parameter does a Mode Preset, which should cover most backward code compatibility issues. The settings and correction data under the Input/Output front-panel key (examples: Input Z Corr, Ext Amp Gain, etc.) are no longer part of any Mode, so they will not be preset by a Mode Preset. They are preset using Restore Input/Output Defaults, Restore System Defaults All. Note that because User Preset does a Recall State, and all of these settings are saved in State, they ARE recalled when using

	User Preset.
Initial S/W Revision	Prior to A.02.00

## How-To Preset

The table below shows all possible presets, their corresponding SCPI commands and front-panel access (key paths). Instrument settings depend on the current measurement context. Some settings are local to the current measurement, some are global (common) across all the measurements in the current mode, and some are global to all the available modes. In a similar way, restoring the settings to their preset state can be done within the different contexts.

Auto Couple - is a measurement local key. It sets all Auto/Man parameter couplings in the measurement to Auto. Any Auto/Man selection that is local to other measurements in the mode will not be affected.

Meas Preset - is a measurement local key. Meas Preset resets all the variables local to the current measurement except the persistent ones.

Mode Preset - resets all the current mode's measurement local and measurement global variables except the persistent ones.

Restore Mode Defaults - resets ALL the Mode variables (and all the Meas global and Meas local variables), including the persistent ones.

Type Of Preset	SCPI Command	Front Panel Access
Auto Couple	:COUPle ALL	Auto Couple front-panel key
Meas Preset	:CONFigure:<Measurement>	Meas Setup Menu
Mode Preset	:SYSTem:PRESet	Mode Preset (green key)
Restore Mode Defaults	:INSTrument:DEFault	Mode Setup Menu
Restore All Mode Defaults	:SYSTem:DEFault MODes	System Menu; Restore System Default Menu
*RST	*RST	not possible (Mode Preset with Single)
Restore Input/Output Defaults	:SYSTem:DEFault INPUt	System Menu; Restore System Default Menu
Restore Power On Defaults	:SYSTem:DEFault PON	System Menu; Restore System Default Menu
Restore Alignment Defaults	:SYSTem:DEFault ALIGN	System Menu; Restore System Default Menu
Restore Miscellaneous Defaults	:SYSTem:DEFault MISC	System Menu; Restore System Default Menu
Restore All System Defaults	:SYSTem:DEFault [ALL] :SYSTem:PRESet:PERsistent	System Menu; Restore System Default Menu
User Preset	:SYSTem:PRESet:USER	User Preset Menu
User Preset All Modes	:SYSTem:PRESet:USER:ALL	User Preset Menu

Power On Mode Preset	:SYSTem:PON:TYPE MODE	System Menu
Power On User Preset	:SYSTem:PON:TYPE USER	System Menu
Power On Last State	:SYSTem:PON:TYPE LAST	System Menu

## Mode Setup

See "[Mode Setup](#)" on page 159

## Peak Search

Displays the Peak Search menu and places the selected marker on the trace point with the maximum y-axis value for that marker's trace.

Key Path	Peak Search
Mode	WIMAXOFDMA
<b>Remote Command</b>	:CALCulate:EVM:MARKer [1]   2   . . . 12:MAXimum
<b>Example</b>	CALC:EVM:MARK2:MAX
Initial S/W Revision	Prior to A.02.00

### Next Peak

Moves the selected marker to the peak that has the next highest amplitude that is less than the marker's current value.

Key Path	Peak Search
Mode	WIMAXOFDMA
<b>Remote Command</b>	:CALCulate:EVM:MARKer [1]   2   . . . 12:MAXimum:NEXT
<b>Example</b>	CALC:EVM:MARK2:MAX:NEXT
Initial S/W Revision	Prior to A.02.00

### Next Pk Right

Moves the selected marker to the next peak to the right of the current marker.

Key Path	Peak Search
Mode	WIMAXOFDMA
<b>Remote Command</b>	:CALCulate:EVM:MARKer [1]   2   . . . 12:MAXimum:RIGHT
<b>Example</b>	CALC:EVM:MARK2:MAX:RIGH
Initial S/W Revision	Prior to A.02.00

### Next Pk Left

Moves the selected marker to the next peak to the left of the current marker.

Key Path	Peak Search
Mode	WIMAXOFDMA
<b>Remote Command</b>	:CALCulate:EVM:MARKer [1]   2   . . . 12:MAXimum:LEFT

---

<b>Example</b>	CALC:EVM:MARK2:MAX:LEFT
Initial S/W Revision	Prior to A.02.00

---

### Marker Delta

Performs the same function as the Delta 1-of-N selection key in the Marker menu. This sets the control mode for the selected marker to Delta mode. The softkey enables you to conveniently perform a peak search and change the marker's control mode to Delta without having to access two separate menus.

---

Key Path	Peak Search
Initial S/W Revision	Prior to A.02.00

---

### Pk-Pk Search

Finds and displays the amplitude and frequency (or time, if in zero span) differences between the highest and lowest y-axis value.

---

Key Path	Peak Search, More
Mode	WIMAXOFDMA
<b>Remote Command</b>	:CALCulate:EVM:MARKer[1] 2 ...12:PTPeak
<b>Example</b>	CALC:EVM:MARK:PTP
Notes	Turns on the Marker $\Delta$ active function.
Dependencies	This key is not available when Coupled Markers is on.
Initial S/W Revision	Prior to A.02.00

---

### Min Search

Moves the selected marker to the minimum y-axis value of the current trace.

---

Key Path	Peak Search, More
Mode	WIMAXOFDMA
<b>Remote Command</b>	:CALCulate:EVM:MARKer[1] 2 ...12:MINimum
<b>Example</b>	CALC:EVM:MARK:MIN
Initial S/W Revision	Prior to A.02.00

---

Print

See "Print " on page 183

## Quick Save

The Quick Save front-panel key repeats the most recent save that was performed from the Save menu, with the following exceptions:

- Register saves are not remembered as Saves for the purpose of the Quick Save function
- If the current measurement does not support the last non-register save that was performed, an informational message is generated, “File type not supported for this measurement”

Quick Save repeats the last type of qualified save (that is, a save qualified by the above criteria) in the last save directory by creating a unique filename using the Auto File Naming algorithm described below.

If Quick Save is pressed after startup and before any qualified Save has been performed, the Quick Save function performs a Screen Image save using the current settings for Screen Image saves (current theme, current directory), which then becomes the “last save” for the purpose of subsequent Quick Saves.

The Auto File Naming feature automatically generates a file name for use when saving a file. The filename consists of a prefix and suffix separated by a dot, as is standard for the Windows® file system. A default prefix exists for each of the available file types:

Type	Default Prefix	Menu
State	State_	(Save/Recall)
Trace + State	State_	(Save/Recall)
Screen	Screen_	(Save/Recall)
Amplitude Corrections	Ampcor_	(Import/Export)
Traces	Trace_	(Import/Export)
Limit Lines	LLine_	(Import/Export)
Measurement Result	MeasR_	(Import/Export)
Capture Buffer	CapBuf_	(Import/Export)

A four digit number is appended to the prefix to create a unique file name. The numbering sequence starts at 0000 within each Mode for each file type and updates incrementally to 9999, then wraps to 0000 again. It remembers where it was through a Mode Preset and when leaving and returning to the Mode. It is reset by Restore Misc Defaults and Restore System Defaults and subsequent running of the instrument application. So, for example, the first auto file name generated for State files is State\_0000.state. The next is State\_0001, and so forth.

One of the key features of Auto File Name is that we guarantee that the Auto File Name will never conflict with an existing file. The algorithm looks for the next available number. If it gets to 9999, then it looks for holes. If it find no holes, that is no more numbers are available, it gives an error.

For example, if when we get to State\_0010.state there is already a State\_0010.state file in the current directory, it advances the counter to State\_0011.state to ensure that no conflict will exist (and then it verifies that State\_0011.state also does not exist in the current directory and advances again if it does, and so forth).



If you enter a file name for a given file type, then the prefix becomes the filename you entered instead of the default prefix, followed by an underscore. The last four letters (the suffix) are the 4-digit number.

For example, if you save a measurement results file as “fred.csv”, then the next auto file name chosen for a measurement results save will be fred\_0000.csv.

**NOTE** Although 0000 is used in the example above, the number that is used is actually the current number in the Meas Results sequence, that is, the number that would have been used if you had not entered your own file name.

**NOTE** If the filename you entered ends with \_dddd, where d=any number, making it look just like an auto file name, then the next auto file name picks up where you left off with the suffix being dddd + 1.

Key Path	Front-panel key
Notes	No remote command for this key specifically.
Initial S/W Revision	Prior to A.02.00

## Recall

The Recall menu lets you choose what you want to recall, and where you want to recall it from. Among the types of files you can recall are **States and Traces**. In addition, an Import (Data) option lets you recall a number of data types stored in CSV files (as used by Excel and other spreadsheet programs).

**NOTE**

In products that run multiple instances of the X-Series Application, all instances share the same register and file location where you want to recall from.

The default paths for Recall are data type dependent and are the same as for the Save key.

Key Path	Front-panel key
Notes	<p>No remote command for this key specifically, but the :MMEM:LOAD command is available for specific file types. An example is :MMEM:LOAD:STATe &lt;filename&gt;.</p> <p>If you try to recall a State file for a mode that is not licensed or not available in the instrument, an error message will occur and the state will not change.</p>
Backwards Compatibility Notes	<p>In legacy analyzers, it was possible to load a state without affecting the trace data, limit lines or correction data. Similarly (since User Preset is actually loading a state), it was possible to do a User Preset without affecting the trace data, limit lines or correction data.</p> <p>In the X-Series, "state" always includes all of this data; so whenever state is loaded, all of the traces, limit lines and corrections are affected. Although this differs from previous behavior, it is desirable behavior, and should not cause adverse issues for users.</p>
Backwards Compatibility Notes	<p>Recall for the X-Series supports backward compatibility in the sense that you can recall a state file from any X-Series model number and any version of X-Series software. This is only possible if part of the recalling process goes through a limiting step after recalling the mode settings, at least for settings that may vary with version number, model number, option and license differences. If you try to recall a state file onto an instrument with less capability than what was available on the instrument during the save, the recall will ignore the state it doesn't support and it will limit the recalled setting to what it allows.</p> <p>Example: if the saved state includes preamp ON, but the recalling instrument does not have a preamp; the preamp is limited to OFF. Conversely, if you save a state without a preamp, the preamp is OFF in the state file. When this saved file is recalled on an instrument with a licensed preamp, the preamp is changed to OFF. Another example is if the saved state has center frequency set to 20 GHz, but the instrument recalling the saved state is a different model and only supports 13.5 GHz. In this case, the center frequency is limited along with any other frequency based settings. Since the center frequency can't be preserved in this case, the recall limiting tries to at least preserve span to keep the measurement setup as intact as possible.</p> <p>It may be appropriate to issue a warning if the state is limited on the recall; warnings do not go out to SCPI so this would only affect the manual user.</p> <p>Note that there is no state file compatibility outside of the X-Series. For example, you cannot recall a state file from ESA or PSA.</p>
Initial S/W Revision	Prior to A.02.00

## State

The Recall State menu lets you choose a register or file from which to recall the state.

The content of a state file includes all of the settings and data required to return the analyzer as closely as possible to the Mode it was in, with the exact settings that were in place, when the save occurred. The Mode settings in each state file include the settings that are affected by Mode Preset, as well as the additional settings affected by Restore Mode Defaults; all of the Mode's settings. In addition, all of the settings of the Input/Output system are included, even though they are outside of the Mode's state, because they are needed to restore the complete setup. Persistent System settings (for example, GPIB address) are not affected by either a Mode Preset or Restore Mode Defaults, nor are they included in a saved State file.

Since each state file is only for one Mode, the settings for other Modes are unaffected when it is loaded. Recall State will cause a mode switch if the state being recalled is not from the current active mode.

After the recall completes, the message "File <filename> recalled" or "Recalled State Register <register number>" is displayed.

For rapid recalls, the State menu lists 16 registers that you can choose from to recall. Pressing a Register key initiates the recall. You can also select a file from which to recall.

The default path for all State Files is:

My Documents\<<mode name>\state

where <mode name> is the parameter used to select the mode with the INST:SEL command (for example, SA for the Spectrum Analyzer).

See ["More Information" on page 1336](#).

<b>Key Path</b>	Recall
<b>Mode</b>	All
<b>Remote Command</b>	:MMEMory:LOAD:STATe <filename>
<b>Example</b>	:MMEM:LOAD:STAT "myState.state" This recalls the file myState.state on the default path
<b>Example</b>	MMEM:LOAD:STAT "MyStateFile.state" This loads the state file data (on the default file directory path) into the instrument state.
<b>Notes</b>	<p>When you pick a file to recall, the analyzer first verifies that the file is recallable in the current instrument by checking the software version and model number of the instrument. If everything matches, a full recall proceeds by aborting the currently running measurement, clearing any pending operations, and then loading the State from the saved state file. You can open state files from any mode, so recalling a State file switches to the mode that was active when the save occurred. After switching to the mode of the saved state file, mode settings and data (if any for the mode) are loaded with values from the saved file. The saved measurement of the mode becomes the newly active measurement and the data relevant to the measurement (if there is any) is recalled.</p> <ul style="list-style-type: none"> <li>• If there is a mismatch between file version or model number or instrument version or model number, the recall function tries to recall as much as possible and returns a warning message. It may limit settings that differ based on model number, licensing or version number.</li> </ul> <p>After recalling the state, the Recall State function does the following:</p> <ul style="list-style-type: none"> <li>• Makes the saved measurement for the mode the active measurement.</li> <li>• Clears the input and output buffers.</li> <li>• Status Byte is set to 0.</li> </ul>

---

	<ul style="list-style-type: none"> <li>• Executes a *CLS</li> </ul> <p>If the file specified is empty an error is generated. If the specified file does not exist, another error is generated. If there is a mismatch between the file and the proper file type, an error is generated. If there is a mismatch between file version or model number or instrument version or model number, a warning is displayed. Then it returns to the State menu and File Open dialog goes away.</p> <p>After the Recall, the analyzer exits the Recall menu and returns to the previous menu.</p>
<b>Backwards Compatibility SCPI</b>	:MMEMory:LOAD:STATe 1,<filename>
Initial S/W Revision	Prior to A.02.00

---

### More Information

In measurements that support saving Traces, for example, Swept SA, the Trace data is saved along with the State in the State file. When recalling the State, the Trace data is recalled as well. Traces are recalled exactly as they were stored, including the writing mode and update and display modes. If a Trace was updating and visible when the State was saved, it will come back updating and visible, and its data will be rewritten right away. When you use State to save and recall traces, any trace whose data must be preserved should be placed in View or Blank mode before saving.

The following table describes the Trace Save and Recall possibilities:

You want to recall state and one trace's data, leaving other traces unaffected.	Save Trace+State from 1 trace. Make sure that no other traces are updating (they should all be in View or Blank mode) when the save is performed.	On Recall, specify the trace you want to load the one trace's data into. This trace will load in View. All other traces' data will be unaffected, although their trace mode will be as it was when the state save was performed.
You want to recall all traces	Save Trace+State from ALL traces.	On Recall, all traces will come back in View (or Blank if they were in Blank or Background when saved)
You want all traces to load exactly as they were when saved.	Save State	On recall, all traces' mode and data will be exactly as they were when saved. Any traces that were updating will have their data immediately overwritten.

### From File...

When you press "From File", the analyzer brings up a Windows dialog and a menu entitled "File Open." This menu allows you to navigate to the various fields in the Windows dialog without using a keyboard or mouse. The Tab and Arrow keys can also be used for dialog navigation.



Listed below are the functions of the various fields in the dialog, and the corresponding softkeys:

#### Open

Performs the recall of the specified file. While the recall is being performed, the floppy icon appears briefly in the Meas bar.

#### File/Folder List

Enables you to navigate to the center of the dialog that contains the list of files and folders. Once here you can get information about the file and use the tab keys to navigate to the other fields in the dialog, such as Look In.

#### Look In

The Look In field shows the path from which the file will be recalled and allows you to change the path using the up and down arrow keys to navigate to other paths; the Enter key to open a directory; and the Backspace key to go back one directory. The **Look In field** first uses the last path from the Save As dialog **Save In:** path for that same file type. There is no softkey for directly navigating to the Look In field, but you can use the left tab to get here from the File/Folder List.

User specified paths are remembered when you leave and return to a Mode and are reset back to the default using Restore Mode Defaults.

#### Sort

Accesses a menu that enables you to sort the files within the File Open dialog. Only one sorting type can be selected at a time and the sorting happens immediately. The sorting types are By Date, By Name, By extension, and By Size.

#### Files of Type

This field shows the file suffix for the type of file you have selected to recall. For example, if you navigated here while recalling State, "Mode state (\*.state)" is in the field. If you navigated here while recalling Trace, ""Mode state (\*.trace)" is in the field. If you navigated here while importing a trace data file, "Trace Data (\*.csv)" is in the field. For some file types, there is more than one choice in the dropdown menu, which you can select by using the up and down arrow keys and Enter.

#### Up One Level

This key corresponds to the icon of a folder with the up arrow that is in the tool bar of the dialog. When pressed, it causes the file and folder list to navigate up one level in the directory structure. The Backspace key does the same thing.

#### Cancel

This key corresponds to the Cancel selection in the dialog. It causes the current **Open** request to be cancelled. The ESC key does the same thing.

Key Path	Recall, State
Notes	Brings up the Open dialog for recalling a State Save Type
Initial S/W Revision	Prior to A.02.00

### Edit Register Names

You may enter a custom name on any of the Register keys, to help you remember what you are using that state to save. To do this, press the Edit Register Names key, choose the register whose name you wish to edit, and then enter the desired label using the Alpha Editor or an external PC keyboard.

The maximum number of characters that can be added is 30. In most cases, 30 characters will fit on two lines of the key.

For more information and the SCPI command, see Edit Register Names under the Save, State function.

Key Path	Recall, State
Mode	All
Dependencies	N9060A-7FP or N9060B-2FP license required to edit the register names. When the feature is not licensed, sending the SCPI command generates an error, -221, "Settings conflict;Option not available"
Initial S/W Revision	A.11.00

### Register 1 thru Register 16

Selecting any one of these register keys causes the State of the mode from the specified Register to be recalled. Each of the register keys annotates whether it is empty or at what date and time it was last

modified. In addition, you can use the Edit Register Names key under Save, State to enter custom names for each register.

**NOTE** In products that run multiple instances of the X-Series Application, recalling the same register name on each instance is a way to share setups between the instances.

Registers are shared by all modes, so recalling from any one of the registers will cause a mode switch to the mode that was active when the save to the Register occurred.

Although these 16 registers are the only registers available from the front panel, there are 128 state registers available in the instrument. Registers 17–128 are only available from the SCPI interface, using the \*RCL command.

After the recall completes, the message "Register <register number> recalled" appears in the message bar. If you are in the Spectrum Analyzer Mode, and you are recalling a register that was saved in the Spectrum Analyzer Mode, then after the recall, you will still be in the Recall Register menu. If the Recall causes you to switch modes, then after the Recall, you will be in the Frequency menu.

If a requested register is empty an error is generated.

Key Path	Recall, State
Example	*RCL 1
Range	1–16 from front panel, 1–128 from SCPI
Readback	Date and time with seconds resolution are displayed on the key OR A custom name of up to 30 characters entered using the Save, State, Edit Register Names key OR “(empty)” if no prior save operation has been performed to this register.
Initial S/W Revision	Prior to A.02.00
Modified at S/W Revision	Prior to A.11.00

## Register 1 thru Register 16

Selecting any one of these register keys causes the State of the mode from the specified Register to be recalled. Each of the register keys annotates whether it is empty or at what date and time it was last modified. In addition, you can use the Edit Register Names key under Save, State to enter custom names for each register.

**NOTE** In products that run multiple instances of the X-Series Application, recalling the same register name on each instance is a way to share setups between the instances.

Registers are shared by all modes, so recalling from any one of the registers will cause a mode switch to the mode that was active when the save to the Register occurred.

Although these 16 registers are the only registers available from the front panel, there are 128 state registers available in the instrument. Registers 17–128 are only available from the SCPI interface, using the \*RCL command.

After the recall completes, the message "Register <register number> recalled" appears in the message bar. If you are in the Spectrum Analyzer Mode, and you are recalling a register that was saved in the Spectrum Analyzer Mode, then after the recall, you will still be in the Recall Register menu. If the Recall causes you to switch modes, then after the Recall, you will be in the Frequency menu.

If a requested register is empty an error is generated.

Key Path	Recall, State
<b>Example</b>	*RCL 1
Range	1-16 from front panel, 1-128 from SCPI
Readback	Date and time with seconds resolution are displayed on the key OR A custom name of up to 30 characters entered using the Save, State,Edit Register Names key OR “(empty)” if no prior save operation has been performed to this register.
Initial S/W Revision	Prior to A.02.00
Modified at S/W Revision	Prior to A.11.00

## Sequences

These keys allow you to import a Tab separated or .txt file that will automatically setup all the parameters required for building a Sequence. The parameters will automatically be loaded into the Stated Sequencer.

Once selected, in order to import the selected Sequence Type you must select the Open key in the Source Sequence menu.

Key Path	Recall, Sequences
Mode	All
<b>Remote Command</b>	:MMEMory:LOAD:SEQuences:   SLISt   ALISt   SAALISt   "MySequence.txt"
<b>Example</b>	:MMEM:LOAD:SEQ:SLIS "MySequence.txt"
Notes	Available file types are: –CSV (Comma delimited) (*.csv) –Text (Tab delimited) (*.txt)
Initial S/W Revision	A.05.00

## Source Sequence

The list of parameters, that configure steps, that makes up a sequence for the Source.

The Source sequence is a sequence of flexible configurable steps that can be set anywhere in the instruments frequency range.

Key Path	Recall,Sequences
----------	------------------



<b>Example</b>	:MMEM:LOAD:SEQ:SLIS "MySequence.txt"
<b>Dependencies</b>	Only available in XOBT
<b>Initial S/W Revision</b>	A.05.00

### Open...

When you press “Open”, the analyzer brings up a Windows dialog and a menu entitled “**File Open.**” This menu allows you to navigate to the various fields in the Windows dialog without using a keyboard or mouse. The Tab and Arrow keys can also be used for dialog navigation.

See "[From File...](#)" on page 1336 in Recall, State, for a full description of this dialog and menu.

<b>Key Path</b>	Recall, Data
<b>Notes</b>	The key location is mode-dependent and will vary. Brings up Open dialog for recalling a <mode specific> Save Type
<b>Initial S/W Revision</b>	Prior to A.02.00

### Data (Import)

Importing a data file loads data that was previously saved from the current measurement or from other measurements and/or modes that produce compatible data files. The Import Menu only contains Data Types that are supported by the current measurement.

Since the commonly exported data files are in .csv format, the data can be edited by the user prior to importing. This allows you to export a data file, manipulate the data in Excel (the most common PC Application for manipulating .csv files) and then import it.

Importing Data loads measurement data from the specified file into the specified or default destination, depending on the data type selected. Selecting an Import Data menu key will not actually cause the importing to occur, since the analyzer still needs to know from where to get the data. Pressing the Open key in this menu brings up the Open dialog and Open menu that provides you with the options from where to recall the data. Once a filename has been selected or entered in the Open menu, the recall occurs as soon as the Open button is pressed.

<b>Key Path</b>	Recall
<b>Mode</b>	All
<b>Notes</b>	The menu is built from whatever data types are available for the mode. Some keys will be missing completely, so the key locations in the sub-menu will vary. No SCPI command directly controls the Data Type that this key controls. The Data Type is included in the MMEM:LOAD commands.
<b>Dependencies</b>	If a file type is not used by a certain measurement, it is grayed out for that measurement. The key for a file type will not show at all if there are no measurements in the Mode that support it.
<b>Preset</b>	Is not affected by Preset or shutdown, but is reset during Restore Mode Defaults

Readback	The data type that is currently selected
Initial S/W Revision	Prior to A.02.00

## Mask

Enables you to recall a preset mask file. This file type (.mask) differs from a normal “state” file because it contains the configuration for Carrier, Offset, and Limit for the specific preset profile BW. A brief description of the mask file is available in the properties view of each file. (Right-mouse-click on the file, select, "Properties" to view this information.) A detailed list of the mask parameter values is located in the .pdf file of the same name in the same directory. Blank values in the .pdf file are parameters that will not be overwritten when recalling the mask.

Key Path	Recall, Data
Mode	WIMAXOFDMA
Remote Command	:MMEMory:LOAD:MASK <string>
Example	:MMEM:LOAD:MASK "MyLimitFile.mask"
Notes	Set of parameters related to Limit, Carrier and Offset are overwritten by Preset Mask file.
Initial S/W Revision	A.02.00

This topic contains the following sections:

["File location and extension" on page 1342](#)

["Example of Preset Mask file" on page 1343](#)

### File location and extension

**File location:** The preset mask file is located in “My Documents\WIMAXOFDMA\data\masks”.

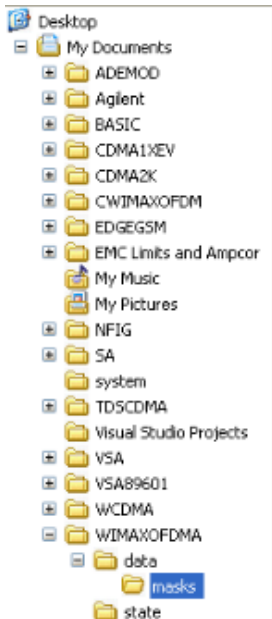
**NOTE**

When your X-Series analyzer starts, all mask files located in “My Documents\WIMAXOFDMA\data/masks” are overwritten, so any files you wish to save should be stored in another directory location.

**File type:** The file type is binary file.

**File Name:** The file name is decided by following naming rules. Each specific keyword is connected with underscore.

<Standard name>\_<Radio device>\_<Preset Profile BW>\_<Measurement>.mask

<Standard name>: This term references the standard associated with each mask file.

<Radio device>: This term specifies to which radio device (BS or MS) the mask file pertains.

<Preset Profile BW>: This term specifies to which Preset Profile BW the mask file pertains.

<Measurement>: This term specifies the measurement to which the mask file is applied. Your selections are: SEM, ACP, or Mode. When selecting **Mode**, the values of some parameters in both the ACP and SEM measurement are overwritten.

**File extension:** The extension of preset mask file is “mask” to distinguish it from a “state” file.

When you press the open key under the Data menu, the “My Documents\WIMAXOFDMA\data\masks” folder is opened. Select one mask file.

**NOTE**

When you change the preset BW profile or Radio Device, all measurement parameters are reset to their original values. Thus you have to recall the appropriate preset mask file again after the change.

### Example of Preset Mask file

When you import a preset mask file, it is a “Recall” function. Specific parameter values are overwritten by the contents of the preset mask file (see table below). Those values not specified by the preset mask file remain unchanged. Because the file format type is binary, you cannot view, change, or create the preset mask file. Here is an example of a preset mask file used for ACP measurements.

File Location: My Documents/WIMAXOFDMA/data/masks

File Name: ETSI-EN301-021-SysE\_BS\_10MHz\_ACP.mask

The .pdf file that lists the parameters similarly to that shown below is named, "ETSI-EN301-021-SysE\_BS\_10MHz\_ACP.pdf"

The set of parameters listed in the following table for the Preset Profile BW (10MHz) are imported into the ACP measurement.

Offset	Start Freq (MHz)	Stop Freq (MHz)	Sweep Time	Res BW (Hz)	Meas BW	Rel Start	Rel Stop	Fail Mask
A	5	7.14		30k	1	-8	-25	Rel
B	7.14	10.57		30k	1	-25	-27	Rel
C	10.57	20		30k	1	-27	-50	Rel
D	20	25		30k	1	-50	-50	Rel
E	25	30		30k	1	-50	-50	Rel

## Zone Map

Pressing this key selects Zone Map as the data type to be imported.

The WiMAX-OFDMA application can load the Singal Studio Setup file, and the OFDMA Map file is compatible with the 89601A Mobile WiMAX omf file.

Key Path	Recall, Data
Remote Command	:MMEMory:LOAD:ZMAP <string>
Example	MMEM:LOAD:ZMAP "ZMap_0000.omf"
Notes	The SCPI parameter is a quoted string that specifies the filename. Both single and double quotes are supported for any filename parameter over SCPI.
Dependencies	You must be in the 802.16 OFDMA (WiMAX/WiBro) mode.
Status Bits/OPC dependencies	Sequential - waits for the previous measurement to complete.
Initial S/W Revision	Prior to A.02.00

## Open...

When you press "Open", the analyzer brings up a Windows dialog and a menu entitled "File Open." This menu allows you to navigate to the various fields in the Windows dialog without using a keyboard or mouse. The Tab and Arrow keys can also be used for dialog navigation.

See "[From File...](#)" on page 1336 in Recall, State, for a full description of this dialog and menu.

Key Path	Recall, Data
Notes	The key location is mode-dependent and will vary. Brings up Open dialog for recalling a <mode specific> Save Type
Initial S/W Revision	Prior to A.02.00

## Restart

The Restart function restarts the current sweep, or measurement, or set of averaged/held sweeps or measurements. If you are Paused, pressing Restart does a Resume.

The Restart function is accessed in several ways:

- Pressing the Restart key
- Sending the remote command INIT:IMMEDIATE
- Sending the remote command INIT:RESTART

See "[More Information](#)" on page 1346

Key Path	Front-panel key
Remote Command	:INITiate[:IMMEDIATE] :INITiate:RESTART
Example	:INIT:IMM :INIT:REST
Notes	:INITiate:RESTART and :INITiate:IMMEDIATE perform exactly the same function.
Couplings	Resets average/hold count k. For the first sweep overwrites all active (update=on) traces with new current data. For application modes, it resets other parameters as required by the measurement.
Status Bits/OPC dependencies	This is an Overlapped command. The STATus:OPERation register bits 0 through 8 are cleared. The STATus:QUESTionable register bit 9 (INTegrity sum) is cleared. The SWEEPING bit is set. The MEASURING bit is set.
Backwards Compatibility Notes	For Spectrum Analysis mode in ESA and PSA, the Restart hardkey and the INITiate:RESTART command restart trace averages (displayed average count reset to 1) for a trace in Clear Write, but did not restart Max Hold and Min Hold.  In the X-Series, the Restart hardkey and the INITiate:RESTART command restart not only Trace Average, but MaxHold and MinHold traces as well.  For wireless comms modes in ESA and PSA, the Restart hardkey and the INITiate:RESTART command restart every measurement, which includes all traces and numeric results. There is no change to this operation.
Initial S/W Revision	Prior to A.02.00

### More Information

The **Restart** function first aborts the current sweep/measurement as quickly as possible. It then resets the sweep and trigger systems, sets up the measurement and initiates a new data measurement sequence with a new data acquisition (sweep) taken once the trigger condition is met.

If the analyzer is in the process of aligning when **Restart** is executed, the alignment finishes before the restart function is performed.

Even when set for Single operation, multiple sweeps may be taken when Restart is pressed (for example, when averaging/holding is on). Thus when we say that **Restart** "restarts a measurement," we may mean:

- It restarts the current sweep
- It restarts the current measurement
- It restarts the current set of sweeps if any trace is in Trace Average, Max Hold or Min Hold
- It restarts the current set of measurements if Averaging, or Max Hold, or Min Hold is on for the measurement
- depending on the current settings.

With **Average/Hold Number** (in **Meas Setup** menu) set to 1, or Averaging off, or no trace in Trace Average or Hold, a single sweep is equivalent to a single measurement. A single sweep is taken after the trigger condition is met; and the analyzer stops sweeping once that sweep has completed. However, with **Average/Hold Number** >1 and at least one trace set to **Trace Average, Max Hold, or Min Hold (SA Measurement)** or **Averaging on (most other measurements)**, multiple sweeps/data acquisitions are taken for a single measurement. The trigger condition must be met prior to each sweep. The sweep is stopped when the average count  $k$  equals the number  $N$  set for **Average/Hold Number**. A measurement average usually applies to all traces, marker results, and numeric results; but sometimes it only applies to the numeric results.

Once the full set of sweeps has been taken, the analyzer will go to idle state. To take one more sweep without resetting the average count, increment the average count by 1, by pressing the step up key while **Average/Hold Number** is the active function, or sending the remote command `CALC:AVER:TCON UP`.

## Save

The Save menu lets you choose what you want to save and where you want to save it. Among the types of files you can save are **States**, **Traces**, and **Screen Images**. In addition, an Export (Data) option lets you save a number of data types as CSV files for easy import into Excel and other spreadsheet programs.

Key Path	Front-panel key
Mode	All
Notes	No remote command for this key specifically, but the :MMEM:STORe command is available for specific file types. An example is :MMEM:STOR:STATe <filename>.
Initial S/W Revision	Prior to A.02.00

## State

The Save State menu lets you choose a register or file for saving the state.

**NOTE** In products that run multiple instances of the X-Series Application, all instances share the same register and file location where you want to save the state.

The content of a state file includes all of the settings and data required to return the analyzer as closely as possible to the Mode it was in, with the exact settings which were in place, when the save occurred. The Mode settings in each state file include the settings that are affected by Mode Preset, as well as the additional settings affected by Restore Mode Defaults; all of the Mode's settings. In addition, all of the settings of the Input/Output system are included, even though they are outside of the Mode's state, because they are needed to restore the complete setup. Persistent System settings (for example, Verbose SCPI) are not affected by either Mode Preset or Restore Mode Defaults, nor are they included in a saved State file.

After the save completes, the message "File <filename> saved" or "State Register <register number> saved" is displayed.

For rapid saving, the State menu lists 16 registers to save to. Pressing a Register key initiates the save. You can also select a file to save to.

The default path for all State Files is:

My Documents\<<mode name>\state

where <mode name> is the parameter used to select the mode with the INST:SEL command (for example, SA for the Spectrum Analyzer).

Key Path	Save
Mode	All
Remote Command	:MMEMory:STORe:STATe <filename>
Example	MMEM:STOR:STATe "MyStateFile.state" This stores the current instrument state data in the file MyStateFile.state in the default directory.
Notes	Both single and double quotes are supported for any filename parameter over remote.



After saving to a register, that register's menu key is updated with the date the time, unless a custom label has been entered for that key.

After saving to a register, you remain in the Save State menu, so that you can see the Register key update. After saving to a file, the analyzer automatically returns to the previous menu and any Save As dialog goes away.

**Backwards Compatibility SCPI** :MMEMory:STORe:STATe 1,<filename>

For backwards compatibility, the above syntax is supported. The "1" is simply ignored. The command is sequential.

Initial S/W Revision Prior to A.02.00

### To File . . .

When you press "To File", the analyzer brings up a Windows dialog and a menu entitled "Save As." This menu allows you to navigate to the various fields in the Windows dialog without using a keyboard or mouse. The Tab and Arrow keys can also be used for dialog navigation.

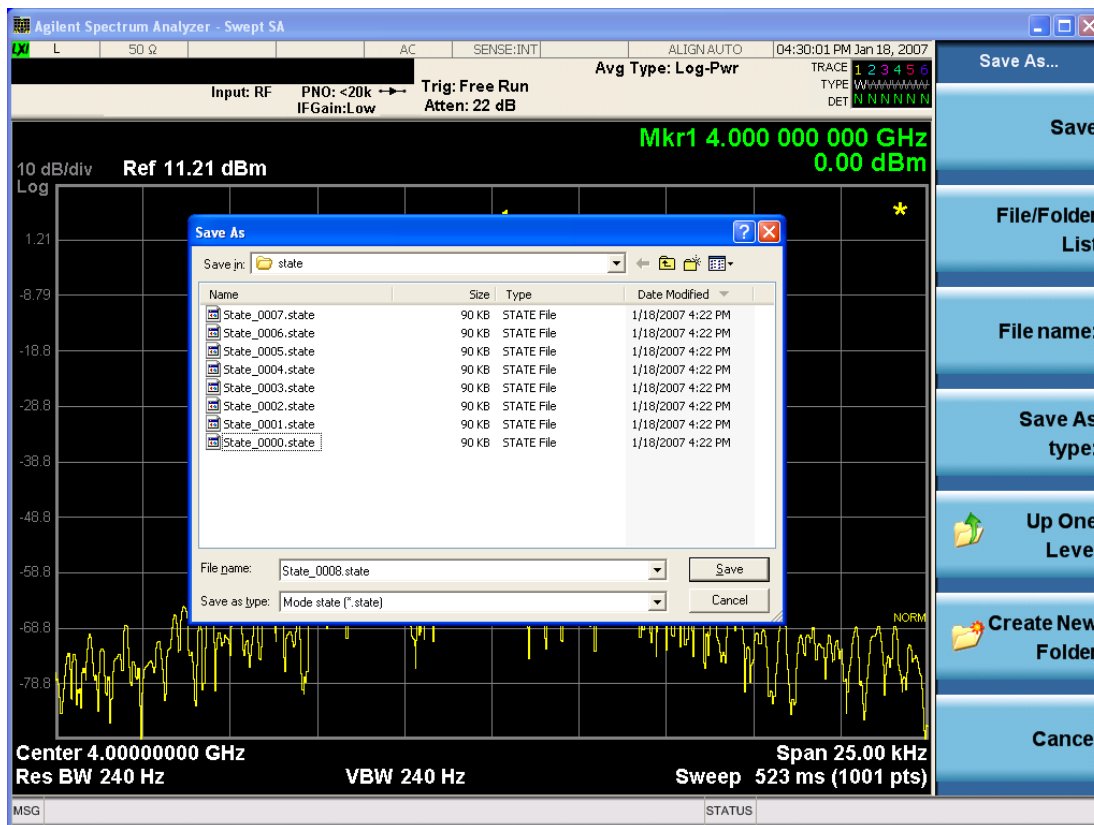

The Listed below

are the functions of the various fields in the dialog, and the corresponding softkeys:

#### Save

Performs the save to the specified file of the selected type. If the file already exists, a dialog will appear that allows you to replace the existing file by selecting OK, or you can Cancel the request. If you select OK,

the file will be overwritten. Using the C: drive is strongly discouraged, since it runs the risk of being overwritten during an instrument software upgrade.

While the save is being performed, the floppy icon appears briefly in the Meas bar.

#### File/Folder List

Enables you to navigate to the center of the dialog that contains the list of files and folders. Once here you can get information about the file and use the tab keys to navigate to the other fields in the dialog, such as Save In.

#### Save In

The Save In field shows the path to which the file will be saved and allows you to change the path using the up and down arrow keys to navigate to other paths; the Enter key to open a directory; and the Backspace key to go back one directory. The **Save In field** defaults to the default path for this type of file and remembers the last path you used to save this type of file. There is no softkey for directly navigating to the Save In field but you can use left tab to get here from the File/Folder List.

User specified paths are remembered when you leave and return to a Mode and are reset back to the default using Restore Mode Defaults.

#### File Name

The File Name field is initially loaded with an automatically generated filename specific to the appropriate Save Type. The automatically generated filename is guaranteed not to conflict with any filename currently in the directory. You may replace or modify this filename using the File Name key. See the ["Quick Save " on page 1332](#) documentation for more on the automatic file naming algorithm.

When you press the File Name key the analyzer displays the Alpha Editor. Use the knob to choose the letter to add and the front-panel Enter key to add the letter to the file name. The BK character moves you back and the FW character moves you forward in the filename. The Select key on the front panel generates a space character. When you are done entering the filename press the Done softkey. This returns back to the **File Open** dialog and menu, but does not cause the save to occur.

#### Save As Type

This field shows the file suffix for the type of file you have selected to save. For example, if you navigated here while saving State, "Mode state (\*.state)" is in the field. If you navigated here from saving Trace, ""Mode state (\*.trace)" is in the field. If you navigated here while exporting a trace data file, "Trace Data (\*.csv)" is in the field. For some file types, there is more than one choice in the dropdown, which you can select by using the up and down arrow keys and Enter.

#### Up One Level

This key corresponds to the icon of a folder with the up arrow that is in the tool bar of the dialog. When pressed, it causes the file and folder list to navigate up one level in the directory structure. The Backspace key does the same thing.

#### Create New Folder

This key corresponds to the icon of a folder with the "\*" that is in the tool bar of the dialog. When pressed, a new folder is created in the current directory with the name **New Folder** and you can enter a new folder name using the Alpha Editor.

#### Cancel

This key corresponds to the Cancel selection in the dialog. It causes the current **Save As** request to be cancelled. The ESC key does the same thing.

Key Path	Save, State
Mode	All
Notes	Brings up Save As dialog for saving a State Save Type
Initial S/W Revision	Prior to A.02.00

## Edit Register Names

You may enter a custom name on any of the Register keys, to help you remember what you are using that state to save. To do this, press the Edit Register Names key, choose the register whose name you wish to edit, and then enter the desired label using the Alpha Editor or an external PC keyboard.

The maximum number of characters that can be added is 30. In most cases, 30 characters will fit on two lines of the key.

See ["More Information" on page 1351](#)

Key Path	Save, State
Mode	All
<b>Remote Command</b>	:MMEMory:REGister:STATe:LABel <reg number>,"label" :MMEMory:REGister:STATe:LABel? <reg number>
<b>Example</b>	:MMEM:REG:STAT:LAB 1,"my label"
Notes	<reg number> is an integer from 1 to 16. If the SCPI specifies an invalid register number an error message is generated, -222,"Data out of range;Invalid register label number" "label" is a string from 0 to 30 characters in length. If a label exceeds 30 characters, an error message is generated, -150,"String data error;Label clipped to 30 characters" "label" of length 0 erases the custom label and restores the default (time and date) label. E.g.: :MMEM:REG:STAT:LAB 1,""
Dependencies	N9060A-7FP or N9060B-2FP license required to edit the register names. When the feature is not licensed, sending this command generates an error, -221,"Settings conflict;Option not available"
Preset	The names are unaffected by Preset or power cycle but are set to the default label (time and date) on a "Restore System Defaults->Misc"
Initial S/W Revision	A.11.00

## More Information

When you edit one of the register names, the time and date field will be replaced by the custom name.

If you delete all the characters in the custom name, it restores the default (time and date).

The register names are stored within the state files, but they are not part of the instrument state; that is, once you have edited a register name, loading a new state will not change that register name. Another

consequence of this is that the names will be persistent through a power cycle. Also, if a named state file is transferred to another analyzer, it will bring its custom name along with it.

If you try to edit the name of an empty register, the analyzer will first save the state to have a file to put the name in. If you load a named state file into an analyzer with older firmware it will ignore the metadata.

The \*SAV and \*RCL commands will not be affected by the custom register names, nor will the MMEM commands.

### Register 1 thru Register 16

Selecting any one of these register menu keys causes the State of the currently active mode to be saved to the specified Register. The registers are provided for rapid saving and recalling, since you do not need to specify a filename or navigate to a file. Each of the register menu keys annotates whether it is empty or at what date and time it was last modified. In addition, you can use the Edit Register Names key to enter custom names for each register.

**NOTE**

In products that run multiple instances of the X-Series Application, save with different register name if you do not want to overwrite the register of another running instance.

Although these 16 registers are the only registers available from the front panel, there are 128 state registers available in the instrument. Registers 17–128 are only available from the SCPI interface, using the \*SAV command.

There is one set of 128 state registers in the instrument, not one set for each Mode. When a state is saved, the Mode it was saved from is saved with it; then when it is recalled, the instrument switches to that Mode.

After the save completes, the corresponding register menu key annotation is updated with the date and time and the message "Register <register number> saved" is displayed.

Key Path	Save, State
Mode	All
Example	*SAV 1
Range	1–16 from front panel, 1–128 from SCPI
Readback	Date and time with seconds resolution are displayed on the key OR A custom name of up to 30 characters entered using the Edit Register Names key OR “(empty)” if no prior save operation has been performed to this register.
Initial S/W Revision	Prior to A.02.00
Modified at S/W Revision	A.11.00

### Register 1 thru Register 16

Selecting any one of these register menu keys causes the State of the currently active mode to be saved to the specified Register. The registers are provided for rapid saving and recalling, since you do not need to specify a filename or navigate to a file. Each of the register menu keys annotates whether it is empty or at

what date and time it was last modified. In addition, you can use the Edit Register Names key to enter custom names for each register.

**NOTE** In products that run multiple instances of the X-Series Application, save with different register name if you do not want to overwrite the register of another running instance.

Although these 16 registers are the only registers available from the front panel, there are 128 state registers available in the instrument. Registers 17–128 are only available from the SCPI interface, using the \*SAV command.

There is one set of 128 state registers in the instrument, not one set for each Mode. When a state is saved, the Mode it was saved from is saved with it; then when it is recalled, the instrument switches to that Mode.

After the save completes, the corresponding register menu key annotation is updated with the date and time and the message "Register <register number> saved" is displayed.

Key Path	Save, State
Mode	All
<b>Example</b>	*SAV 1
Range	1–16 from front panel, 1–128 from SCPI
Readback	Date and time with seconds resolution are displayed on the key OR A custom name of up to 30 characters entered using the Edit Register Names key OR “(empty)” if no prior save operation has been performed to this register.
Initial S/W Revision	Prior to A.02.00
Modified at S/W Revision	A.11.00

### Mass Storage Catalog (Remote Command Only)

Key path	SCPI Only
<b>Remote Command</b>	:MMEMory:CATalog? [<directory_name>]
Notes	The string must be a valid logical path. Queries disk usage information (drive capacity, free space available) and obtains a list of files and directories in a specified directory in the following format: <numeric_value>,<numeric_value>,{<file_entry>} It returns two numeric parameters and as many strings as there are files and directories. The first parameter indicates the total amount of storage currently used in bytes. The second parameter indicates the total amount of storage available, also in bytes. The <file_entry> is a string. Each <file_entry> indicates the name, type, and size of one file in the directory list: <file_name>,<file_type>,<file_size> As the windows file system has an extension that indicates file type, <file_type> is always empty. <file_size> provides the size of the file in bytes. For directories, <file_entry> is surrounded by square brackets and both <file_type> and <file_size> are empty
Initial S/W Revision	Prior to A.02.00

## Mass Storage Change Directory (Remote Command Only)

Key path	SCPI Only
Remote Command	:MMEMory:CDIRectory [<directory_name>] :MMEMory:CDIRectory?
Notes	The string must be a valid logical path. Changes the default directory for a mass memory file system. The <directory_name> parameter is a string. If no parameter is specified, the directory is set to the *RST value. At *RST, this value is set to the default user data storage area, that is defined as System.Environment.SpecialFolder.Personal. Query returns full path of the default directory.
Initial S/W Revision	Prior to A.02.00

## Mass Storage Copy (Remote Command Only)

Key path	SCPI Only
Remote Command	:MMEMory:COPY <string>,<string>[,<string>,<string>]
Notes	The string must be a valid logical path. Copies an existing file to a new file or an existing directory to a new directory. Two forms of parameters are allowed. The first form has two parameters. In this form, the first parameter specifies the source, and the second parameter specifies the destination. The second form has four parameters. In this form, the first and third parameters specify the source. The second and fourth parameters specify the directories. The first pair of parameters specifies the source. The second pair specifies the destination. An error is generated if the source doesn't exist or the destination file already exists. This command will generate an "access denied" error if the destination is a restricted folder (e.g., C:\Windows) and the current user does not have Power User or Administrator privileges.

## Mass Storage Device Copy (Remote Command Only)

This command transfers data to/from a file and a peripheral device.

Key path	SCPI Only
Remote Command	:MMEMory:COPY:DEvice <source_string>,<dest_string>
Notes	The strings must be a valid logical path or a valid device keyword. If the dest_string is a device keyword, the data is copied from the source file to the device. If the source_string is a device keyword, the data is copied to the source file from the device. Valid device keywords are: SNS (smart noise source) An error is generated if the file or device is not found.

## Mass Storage Delete (Remote Command Only)

Key path	SCPI Only
<b>Remote Command</b>	:MMEMory:DELeTe <file_name>[,<directory_name>]
Notes	The string must be a valid logical path. Removes a file from the specified directory. The <file_name> parameter specifies the file name to be removed. This command will generate an “access denied” error if the file is in a restricted folder (e.g., C:\Windows) and the current user does not have Power User or Administrator privileges.
Initial S/W Revision	Prior to A.02.00

## Mass Storage Data (Remote Command Only)

Creates a file containing the specified data OR queries the data from an existing file.

Key path	SCPI Only
<b>Remote Command</b>	:MMEMory:DATA <file_name>, <data> :MMEMory:DATA? <file_name>
Notes	The string must be a valid logical path. The command form is MMEMory:DATA <file_name>,<data>. It loads <data> into the file <file_name>. <data> is in 488.2 block format. <file_name> is string data. The query form is MMEMory:DATA? <file_name> with the response being the associated <data> in block format.
Initial S/W Revision	Prior to A.02.00

## Mass Storage Make Directory (Remote Command Only)

Key path	SCPI Only
<b>Remote Command</b>	:MMEMory:MDIRectory <directory_name>
Notes	The string must be a valid logical path. Creates a new directory. The <directory_name> parameter specifies the name to be created. This command will generate an “access denied” error if the new directory would be in a restricted folder (e.g., C:\Windows) and the current user does not have Power User or Administrator privileges.
Initial S/W Revision	Prior to A.02.00

## Mass Storage Move (Remote Command Only)

Key path	SCPI Only
<b>Remote Command</b>	:MMEMory:MOVE <string>,<string>[,<string>,<string>]
Notes	The string must be a valid logical path. Moves an existing file to a new file or an existing directory to a new directory.

---

Two forms of parameters are allowed. The first form has two parameters. In this form, the first parameter specifies the source, and the second parameter specifies the destination.

The second form has four parameters. In this form, the first and third parameters specify the source. The second and fourth parameters specify the directories. The first pair of parameters specifies the source. The second pair specifies the destination. An error is generated if the source doesn't exist or the destination file already exists.

This command will generate an "access denied" error if the destination is a restricted folder (e.g., C:\Windows) and the current user does not have Power User or Administrator privileges.

---

Initial S/W Revision      Prior to A.02.00

---

### Mass Storage Remove Directory (Remote Command Only)

---

Key path                      SCPI Only

---

**Remote Command**        :MMEMory:RDIRECTory <directory\_name>

---

Notes

The string must be a valid logical path.

Removes a directory. The <directory\_name> parameter specifies the directory name to be removed. All files and directories under the specified directory shall also be removed.

This command will generate an "access denied" error if the folder is a restricted folder (e.g., C:\Windows) or is in a restricted folder and the current user does not have Power User or Administrator privileges.

---

Initial S/W Revision      Prior to A.02.00

---

### Mass Storage Determine Removable Media (Remote Command Only)

This command is used to determine if any removable media devices are connected to the instrument. Primarily, these are USB memory devices plugged-in to the front panel or rear panel USB ports. On instruments with PC6 or PC7 CPU's, one SD card slot is available for removable media. The instrument's primary disk drive is not a removable media device.

---

Key Path                      SCPI Only

---

**Remote Command**        :MMEMory:RMEDIA:LIST?

---

Notes

The return value will be a string containing a list of partition identifiers which are removable media devices. Each identifier will be separated by a comma. If no removable media is present, an empty string will be returned.

Examples:

One removable device present will result in a return string of "F:".

Two removable devices present will result in a return string of "F:,G:".

No removable devices present will result in a return string of "".

---

Initial S/W Revision      x.15.00

---



### Mass Storage Determine Removable Media Label (Remote Command Only)

This command is used to set or query a removable media device's label.

Key Path	SCPI Only
<b>Remote Command</b>	:MMEMory:RMEDia:LABel <partition>,<string> :MMEMory:RMEDia:LABel? <partition>
<b>Example</b>	MMEM:RMED:LAB "F:","My Device"
Notes	If the <partition> specified does not exist or is not a removable media device the error -252,"Missing Media" will be generated.  Setting the removable media label requires Administrative privileges. If the currently logged in user does not have appropriate privileges the error "-221.9900,Settings conflict;Administrator privileges required" is generated.
Initial S/W Revision	x.15.00

### Mass Storage Determine Removable Media Write-protect status (Remote Command Only)

This command is used to query a removable media device's write-protect status.

Key Path	SCPI Only
<b>Remote Command</b>	:MMEMory:RMEDia:WPRotect? <partition>
<b>Example</b>	MMEM:RMED:WPR? "F:"
Notes	The return value is 1 if the device is write-protected, and 0 if the device is write-enabled.  If the <partition> specified does not exist or is not a removable media device the error -252,"Missing Media" will be generated.
Preset	The return value will be depending on SD card installed.
Initial S/W Revision	x.15.00

### Mass Storage Determine Removable Media size (Remote Command Only)

This command is used to query a removable media device's total memory size (not available memory size).

Key Path	SCPI Only
<b>Remote Command</b>	:MMEMory:RMEDia:SIZE? <partition>
<b>Example</b>	MMEM:RMED:SIZE? "F:"
Notes	The return value is integer value in GBytes. Any device which is less than 1 GB will return 0 GB.  If the <partition> specified does not exist or is not a removable media device the error -252,"Missing Media" will be generated.
Initial S/W Revision	x.15.00

## Sequences

These keys allow you to save a Tab separated or CSV file of the setup parameters required to build a Sequence.

In order to save you must select the Save As button and choose a destination folder.

Key Path	Save, Sequences
Mode	All
Remote Command	:MMEM:STOR:SEQ:SLIST   SLIST   ALIST   SAALIST   SSTEP "MySequence.txt"
Example	:MMEM:STOR:SEQ:SLIST "MySequence.txt"
Notes	Available file types are: –CSV (Comma delimited) (*.csv) –Text (Tab delimited) (*.txt)
Initial S/W Revision	A.05.00

## Source Sequence

The list of parameters, that configure steps, that makes up a sequence for the Source.

The Source sequence is a sequence of flexible configurable steps that can be set anywhere in the instruments frequency range.

Key Path	Save, Sequences
Example	:MMEM:STOR:SEQ:SLIS "MySequence.txt"
Dependencies	Only available in XOBT
Initial S/W Revision	A.05.00

## Save As . . .

This menu lets you select the location where you can save the Sequence. This menu is a standard Windows® dialog with Save As menu keys. The "File Name" field in the Save As dialog is initially loaded with an automatically generated filename specific to the appropriate Save Type. The automatically generated filename is guaranteed not to conflict with any filename currently in the directory. You may replace or modify this filename using the File Name softkey. See the Quick Save key documentation for more on the automatic file naming algorithm.

The default path for all Sequence Files is:

My Documents\Sequences

Key Path	Save, Sequences
Mode	All

Notes	Brings up Save As dialog for saving a Sequence Save Type
Initial S/W Revision	A.05.00

## Data (Export)

Exporting a data file stores data from the current measurement to mass storage files. The Export Menu only contains data types that are supported by the current measurement.

Since the commonly exported data files are in .csv format, the data can be edited by you prior to importing. This allows you to export a data file, manipulate the data in Excel (the most common PC Application for manipulating .csv files) and then import it.

Selecting an Export Data menu key will not actually cause the exporting to occur, since the analyzer still needs to know where you wish to save the data. Pressing the Save As key in this menu brings up the Save As dialog and Save As menu that allows you to specify the destination file and directory. Once a filename has been selected or entered in the Open menu, the export will occur as soon as the Save key is pressed.

Key Path	Save
Mode	All
Notes	The menu is built from whatever data types are available for the mode. So the key locations in the sub menu will vary. No SCPI command directly controls the Data Type that this key controls. The Data Type is included in the MMEM:STORe commands.
Dependencies	If a file type is not used by a certain measurement, that type is grayed out for that measurement. The key for a file type will not show at all if there are no measurements in the Mode that support it.
Preset	Is not affected by a Preset or shutdown, but is reset during Restore Mode Defaults
Readback	The data type that is currently selected
Initial S/W Revision	Prior to A.02.00

## Measurement Results

Pressing this key selects Meas Results as the data type to be exported. Pressing the key a second time brings up the Meas Results menu, which allows you to select which **Meas Result** to save. In the Swept SA measurement, there are three types of Measurement Results files: Peak Table, Marker Table and Spectrogram.

See "[Meas Results File Contents](#)" on page 1360.

See "[Marker Table](#)" on page 1360.

See "[Peak Table](#)" on page 1363.

See "[Spectrogram](#)" on page 1366

Remote Command	:MMEMory:STORe:RESuLts:MTABle PTABle SPEctrogram <filename>
----------------	-------------------------------------------------------------

---

<b>Example</b>	<p>:MMEM:STOR:RES:MTAB "myResults.csv" Saves the results from the current marker table to the file myResults.csv in the current path.</p> <p>:MMEM:STOR:RES:PTAB "myResults.csv" Saves the results from the current peak table to the file myResults.csv in the current path.</p> <p>:MMEM:STOR:RES:SPEC "myResults.csv" Saves the results from the current Spectrogram display to the file myResults.csv in the current path.</p> <p>The default path is My Documents\SA\data\SAN\results</p>
<b>Notes</b>	<p>If the save is initiated via SCPI, and the file already exists, the file will be overwritten.</p> <p>Using the C: drive is strongly discouraged, since it runs the risk of being overwritten during an instrument software upgrade.</p> <p>Both single and double quotes are supported for any filename parameter over SCPI.</p>
<b>Dependencies</b>	<p>If a save of Marker Table results is requested and the Marker Table is not on, no file is saved and a message is generated</p> <p>If a save of Peak Table results is requested and the Peak Table is not on, no file is saved and a message is generated</p> <p>If a save of Spectrogram results is requested and the Spectrogram is not on, no file is saved and a message is generated.</p> <p>The Spectrogram choice only appears if option EDP is licensed.</p>
<b>Preset</b>	Not part of Preset, but is reset to Peak Table by Restore Mode Defaults. Survives a shutdown.
<b>Initial S/W Revision</b>	Prior to A.02.00

---

## Meas Results File Contents

All files are .csv files. The following section details the data in each file type.

### Marker Table

This section discusses the Marker Table Meas Results file format.

Imagine that, at the point where a Marker Table Meas Result is requested, the following screen is showing:

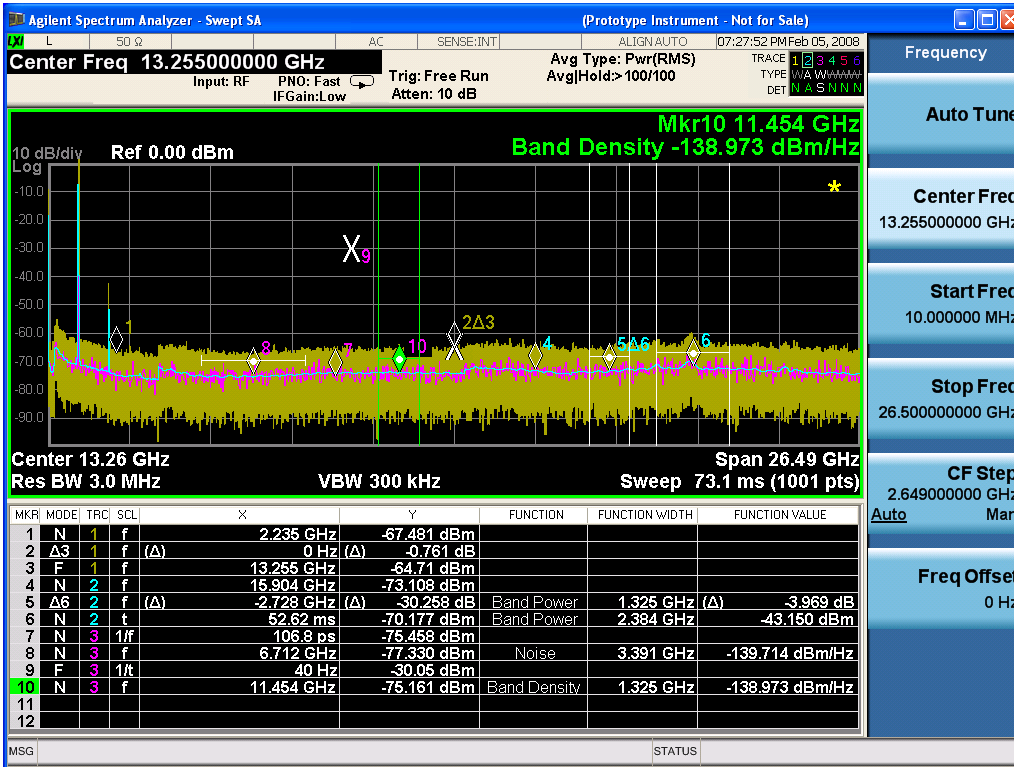

Then the Meas Results file, when opened, would show the following data:

MeasurementR	
result	
Swept SA	
A.01.40_R0017	N9020A
526 B25 PFR	1
P26 EA3	
Result Type	Marker Table
Ref Level	0
Number of Points	1001
Sweep Time	0.0662666 67
Start Frequency	10000000
Stop Frequency	26500000 000
Average Count	0
Average Type	LogPower (Video)
RBW	3000000

RBW Filter	Gaussian
RBW Filter BW	3dB
VBW	3000000
Sweep Type	Swept
X Axis Scale	Lin
PreAmp State	Off
PreAmp Band	Low
Trigger Source	Free
Trigger Level	1.2
Trigger Slope	Positive
Trigger Delay	1.00E-06
Phase Noise Optimization	Fast
Swept If Gain	Low
FFT If Gain	Autorange
RF Coupling	AC
FFT Width	411900
Ext Ref	10000000
Input	RF
RF Calibrator	Off
Attenuation	10
Ref Level Offset	0
External Gain	0
X Axis Units	Hz
Y Axis Units	dBm

DATA									
MKR	MODE	TR C	SCL	X	Y	FUNCTI ON	FUNCTIO N WIDTH	FUNCTI ON VALUE	FUNCTI ON UNIT
1	Normal	1	Freque ncy	2.2350E+09	- 67.481	Off	0.0000E+00	0	None
2	Delta3	1	Freque ncy	0.0000E+00	- 0.761	Off	0.0000E+00	0	None
3	Fixed	1	Freque ncy	1.3255E+10	- 64.71	Off	0.0000E+00	0	None
4	Normal	2	Freque ncy	1.5904E+10	- 73.1	Off	0.0000E+00	0	None

08									
5	Delta7	2	Freque ncy	- 2.7280E+ 09	- 30.2 58	Band Power	1.3250E+ 06	-3.969	dB
6	Normal	2	Time	5.2620E- 02	- 70.1 77	Band Power	2.3840E+ 06	-43.15	dBm
7	Normal	3	Period	1.0680E- 10	- 75.4 58	Off	0.0000E+ 00	0	None
8	Normal	3	Freque ncy	6.7120E+ 09	- 77.3 3	Noise	3.3910E+ 06	- 139.71 4	dBm/Hz
9	Fixed	3	Inverse Time	4.0000E+ 01	- 30.0 5	Off	0.0000E+ 00	0	None
10	Normal	3	Freque ncy	1.1454E+ 10	- 75.1 61	Band Density	1.3250E+ 06	- 138.97 3	dBm/Hz
11	Off	1	Freque ncy	0.0000E+ 00	0	Off	0.0000E+ 00	0	None
12	Off	1	Freque ncy	0.0000E+ 00	0	Off	0.0000E+ 00	0	None

The numbers appear in the file exactly as they appear onscreen. If it says 11.454 GHz onscreen, then in the file it is 11.454E+09.

The metadata header is very similar to the metadata used in the trace data .csv files. See Trace File Contents. The only new information concerns the 1-of-N fields in the marker table itself.

### Peak Table

This section discusses the Peak Table Meas Results file format.

Imagine that, at the point where a Marker Table Meas Result is requested, the following screen is showing:

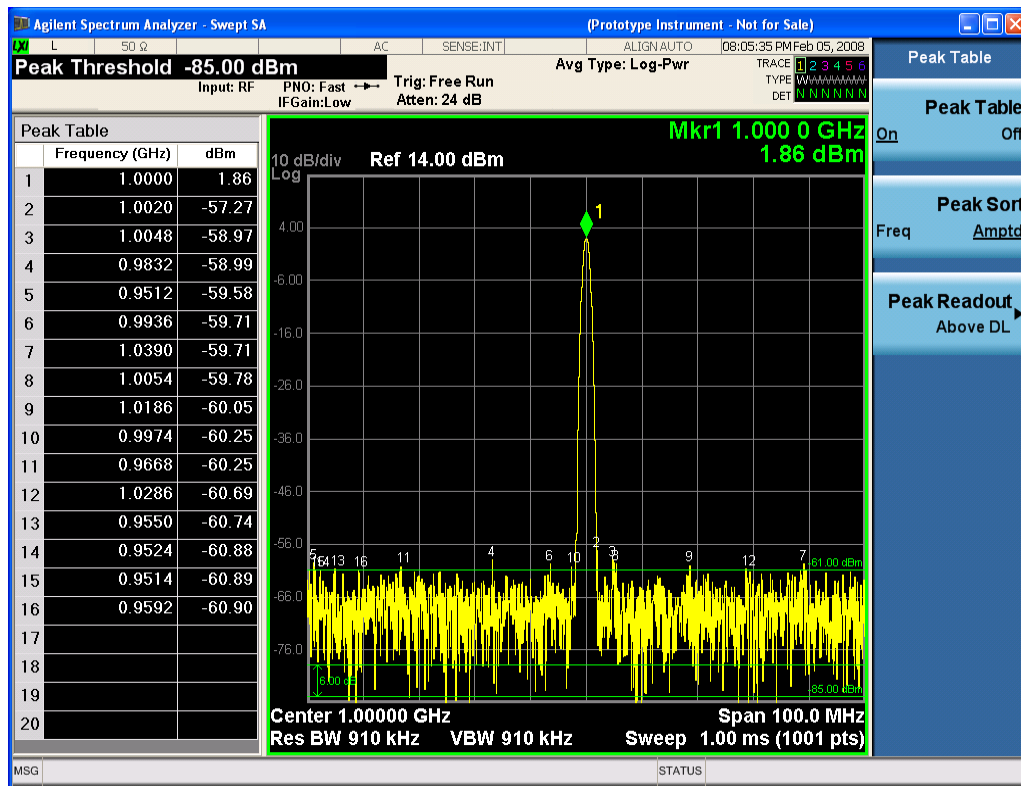

Then the Meas Results file, when opened, would show the header data (the same as for the Marker Table except that the Result Type is Peak Table) ending with a few fields of specific interest to Peak Table users:

- Peak Threshold
- Peak Threshold State (On|Off)
- Peak Excursion
- Peak Excursion State (On|Off)
- Display Line
- Peak Readout (All|AboveDL|BelowDL)
- Peak Sort (Freq|Amptd)

These fields are then followed by the data for the Peak Table itself.

Note that the label for the Frequency column changes to Time in 0 span.

Here is what the table for the above display looks like:

MeasurementResult	
Swept SA	
A.01.40_R0017	N9020A
526 B25 PFR P26 EA3	1



Result Type	Peak Table
Ref Level	0
Number of Points	1001
Sweep Time	0.066266667
Start Frequency	10000000
Stop Frequency	26500000000
Average Count	0
Average Type	LogPower(Video)
RBW	3000000
RBW Filter	Gaussian
RBW Filter BW	3dB
VBW	3000000
Sweep Type	Swept
X Axis Scale	Lin
PreAmp State	Off
PreAmp Band	Low
Trigger Source	Free
Trigger Level	1.2
Trigger Slope	Positive
Trigger Delay	1.00E-06
Phase Noise Optimization	Fast
Swept If Gain	Low
FFT If Gain	Autorange
RF Coupling	AC
FFT Width	411900
Ext Ref	10000000
Input	RF
RF Calibrator	Off
Attenuation	10
Ref Level Offset	0
External Gain	0
X Axis Units	Hz
Y Axis Units	dBm
Peak Threshold	-85
Peak Threshold State	On
Peak Excursion	6
Peak Excursion State	On

Display Line	-61	
Peak Readout	AboveDL	
Peak Sort	Amptd	
DATA		
Peak	Frequency	Amplitude
1	1.0000E+06	1.86
2	1.0020E+06	-57.27
3	1.0048E+06	-58.97
4	9.8320E+05	-58.99
5	9.5120E+05	-59.58
6	9.9360E+05	-59.71
7	1.0390E+06	-59.71
8	1.0054E+06	-59.78
9	1.1086E+06	-60.05
10	9.9740E+05	-60.25
11	9.6680E+05	-60.25
12	1.0286E+06	-60.69
13	9.5500E+05	-60.74
14	9.5240E+05	-60.88
15	9.5140E+05	-60.89
16	9.5920E+05	-60.90
17		
18		
19		
20		

### Spectrogram

This section discusses the Spectrogram Results file format. The Spectrogram choice only appears if option EDP is licensed.

The Spectrogram results are the same as a Trace data export, except that instead of having just one trace's data, all 300 traces appear one after the other.

Each trace has its own data mark; the data for Spectrogram Trace 0 follows the row marked DATA, the data for Spectrogram Trace 1 follows the row marked DATA1, for Spectrogram Trace 2 follows the row marked DATA2, and so on.

Each DATA row has a timestamp in the second column (as of firmware revision A.11.01). So, for example, if Trace 0 had a relative start time of 1729.523 sec, then the first DATA row would look like this:

DATA,1729.523

And if Trace 13 had a relative start time of 100.45 sec, then the fourteenth data row would look like:

DATA13,100.453

To find the absolute time for the relative timestamps of each trace, the last row before the first DATA row gives the absolute start time of the Spectrogram, in the form YYYYMMDDHHMMSS

So, for example, if the absolute start time is 13:23:45:678 on January 30, 2012, this row would look like:

Start Time,20120130132345678

NOTE:

**NOTE** The resolution of the absolute time stored is 1 ms, which matches up with the fact that the fastest sweep time is also 1 ms. However, there is no specification for the absolute accuracy of the clock in the analyzer, nor is there any facility provided to allow the user to set this time to any particular degree of accuracy.

Traces that have not yet been filled in the Spectrogram display are empty; there is no DATA header for them. The file ends after the last non-empty trace.

Imagine that, at the point where a Spectrogram Meas Result is requested, the following screen is showing:



For the purpose of this example, we have set the Average/Hold Number to 10, thus we have only traces 0 thru 10. The Spectrogram was started at 02:28:08:700 pm on April 25, 2012 (that is, 700 ms after 2:28:08 pm), although the screen dump itself shows a different time, as it was taken ten minutes after the Spectrogram data. Trace 0 is showing a start time of 5.30 seconds, meaning 5.3 seconds after the Spectrogram started (trace 10 has a start time of 0, as it was the first trace taken but has now rolled up into the tenth trace slot).

The Meas Results file, when opened, shows the header data and ten traces of trace data. Below is an extract from the result file for the above display. Note the start time of 20120425142808700 showing in the last row before the first DATA row, and the relative time of 5.299231048 showing in the first DATA row:

<b>Result Type</b>	<b>Spectrogram</b>
MeasResult	
Swept SA	
A.11.00.01	N9020A
F03 F07 F13 F26 ALL ALV B1C B1X B25 B2X B40 BAB BBA CR3 CRP DP2 DRD EA3 EDP EMC EP1 ERC ESC ESP EXM FSA HBA K03 LFE MPB P03 P08 P13 P26 PFR RTL RTS S40 SB1 SEC SM1 UK6 YAS YAV	1
Segment	0
Number of Points	1001
Sweep Time	0.523333333
Start Frequency	5999984415
Stop Frequency	6000009415
Average Count	0
Average Type	LogPower(Video)
RBW	240
RBW Filter	Gaussian
RBW Filter BW	3dB
VBW	240
Sweep Type	Swept
X Axis Scale	Lin
PreAmp State	Off
PreAmp Band	Low
Trigger Source	Free
Trigger Level	1.2
Trigger Slope	Positive
Trigger Delay	0
Phase Noise Optimization	Wide
Swept If Gain	Low

Result Type	Spectrogram
FFT If Gain	Autorange
RF Coupling	AC
FFT Width	411900
Ext Ref	10000000
Input	RF
RF Calibrator	Off
Attenuation	14
Ref Level Offset	0
External Gain	0
Trace Type	Clearwrite
Detector	Normal
Trace Math	Off
Trace Math Oper1	Trace5
Trace Math Oper2	Trace6
Trace Math Offset	0
Trace Name	Trace1
X Axis Units	Hz
Y Axis Units	dBm
Start Time	20120425142808700
DATA	5.299231048
5999984415	-76.34749519
5999984440	-77.28097006
5999984465	-75.32317869
5999984490	-73.64417681
5999984515	-72.67154604

○  
○  
○

6000009315	-77.94423277
6000009340	-79.51829697
6000009365	-78.46108961
6000009390	-78.46108957
6000009415	-76.59570596
DATA2	4.708697055

5999984415	-80.98197882
5999984440	-80.98197879
5999984465	-75.83142132
5999984490	-74.02712079
5999984515	-73.57213005

o

o

o

6000009315	-75.9183103
6000009340	-79.53787488
6000009365	-78.82602191
6000009390	-78.82602188
6000009415	-76.37486709
DATA10	0
5999984415	-75.56751112
5999984440	-75.76485645
5999984465	-76.67718717
5999984490	-78.79238489
5999984515	-83.72680212

o

o

o

6000009315	-71.3942461
6000009340	-72.28308332
6000009365	-73.92684489
6000009390	-75.45548832
6000009415	-75.17904815

## Zone Map

Pressing this key selects Zone Map as the data type to be exported.

The Zone Map file contains information about current Zone Map configuration. Its format is compatible with the 89601A OFDMA map file. It is detailed in ["Zone Map File Contents" on page 1371](#) below.

Key Path	Save, Data
<b>Remote Command</b>	:MMEMory:STORe:ZMAP <string>
<b>Example</b>	MMEM:STOR:ZMAP "ZMap_0000.omf"
Notes	<p>If the save is initiated via SCPI and the file already exists, the file will be overwritten.</p> <p>The SCPI command exports Zone Map information to the file specified as the parameter in the current path. The default path is My Documents\WIMAXOFDMA\.</p> <p>Using the C: drive is strongly discouraged, since it runs the risk of being overwritten during an instrument software upgrade.</p> <p>The SCPI parameter is a quoted string that specifies the filename. Both single and double quotes are supported for any filename parameter over SCPI.</p>
Dependencies	You must be in the 802.16 OFDMA (WiMAX/WiBro) mode.
Status Bits/OPC dependencies	Sequential – waits for the previous measurement to complete.
Initial S/W Revision	Prior to A.02.00

## Zone Map File Contents

A Zone Map File contains the following information of the Zone Map configuration. See ["Zone Map Data" on page 171](#) for detailed definitions.

- DemodOfdmaMap\_AutoDetect
- DemodOfdmaMap\_Count
- DemodOfdmaMap\_F1\_DL\_Count
- DemodOfdmaMap\_F1\_DL\_Z1\_Active
- DemodOfdmaMap\_F1\_DL\_Z1\_AmcType
- DemodOfdmaMap\_F1\_DL\_Z1\_B1\_Active
- DemodOfdmaMap\_F1\_DL\_Z1\_B1\_AllocType
- DemodOfdmaMap\_F1\_DL\_Z1\_B1\_Boost
- DemodOfdmaMap\_F1\_DL\_Z1\_B1\_BurstType
- DemodOfdmaMap\_F1\_DL\_Z1\_B1\_ColorIndex
- DemodOfdmaMap\_F1\_DL\_Z1\_B1\_ModType
- DemodOfdmaMap\_F1\_DL\_Z1\_B1\_Name
- DemodOfdmaMap\_F1\_DL\_Z1\_B1\_SubchannelInterval
- DemodOfdmaMap\_F1\_DL\_Z1\_B1\_SubchannelOffset
- DemodOfdmaMap\_F1\_DL\_Z1\_B1\_SymbolInterval

- DemodOfdmaMap\_F1\_DL\_Z1\_B1\_SymbolOffset
- DemodOfdmaMap\_F1\_DL\_Z1\_Count
- DemodOfdmaMap\_F1\_DL\_Z1\_DedicPilots
- DemodOfdmaMap\_F1\_DL\_Z1\_IDCell
- DemodOfdmaMap\_F1\_DL\_Z1\_IDCellCouple
- DemodOfdmaMap\_F1\_DL\_Z1\_Len
- DemodOfdmaMap\_F1\_DL\_Z1\_Locked
- DemodOfdmaMap\_F1\_DL\_Z1\_Name
- DemodOfdmaMap\_F1\_DL\_Z1\_PrbsID
- DemodOfdmaMap\_F1\_DL\_Z1\_StcMatrix
- DemodOfdmaMap\_F1\_DL\_Z1\_StcType
- DemodOfdmaMap\_F1\_DL\_Z1\_SymOffset
- DemodOfdmaMap\_F1\_DL\_Z1\_UseAllSC
- DemodOfdmaMap\_F1\_DL\_Z1\_WrapType
- DemodOfdmaMap\_F1\_DL\_Z1\_ZoneType
- DemodOfdmaMap\_F1\_UL\_Count
- DemodOfdmaMap\_F1\_UL\_Z1\_Active
- DemodOfdmaMap\_F1\_UL\_Z1\_AmcType
- DemodOfdmaMap\_F1\_UL\_Z1\_B1\_Active
- DemodOfdmaMap\_F1\_UL\_Z1\_B1\_AllocType
- DemodOfdmaMap\_F1\_UL\_Z1\_B1\_Boost
- DemodOfdmaMap\_F1\_UL\_Z1\_B1\_BurstType
- DemodOfdmaMap\_F1\_UL\_Z1\_B1\_ColorIndex
- DemodOfdmaMap\_F1\_UL\_Z1\_B1\_ModType
- DemodOfdmaMap\_F1\_UL\_Z1\_B1\_Name
- DemodOfdmaMap\_F1\_UL\_Z1\_B1\_PilotPattern
- DemodOfdmaMap\_F1\_UL\_Z1\_B1\_StcMode
- DemodOfdmaMap\_F1\_UL\_Z1\_B1\_SubchannelInterval
- DemodOfdmaMap\_F1\_UL\_Z1\_B1\_SubchannelOffset
- DemodOfdmaMap\_F1\_UL\_Z1\_B1\_SymbolInterval
- DemodOfdmaMap\_F1\_UL\_Z1\_B1\_SymbolOffset



- DemodOfdmaMap\_F1\_UL\_Z1\_Count
- DemodOfdmaMap\_F1\_UL\_Z1\_Gap
- DemodOfdmaMap\_F1\_UL\_Z1\_IDCell
- DemodOfdmaMap\_F1\_UL\_Z1\_Len
- DemodOfdmaMap\_F1\_UL\_Z1\_Locked
- DemodOfdmaMap\_F1\_UL\_Z1\_Name
- DemodOfdmaMap\_F1\_UL\_Z1\_SymOffset
- DemodOfdmaMap\_F1\_UL\_Z1\_UseSubchRotate
- DemodOfdmaMap\_F1\_UL\_Z1\_WrapType
- DemodOfdmaMap\_F1\_UL\_Z1\_ZoneType
- DemodOfdmaMap\_Name
- DemodOfdmaMap\_RefreshMap

### Save As . . .

When you press “Save As”, the analyzer brings up a Windows dialog and a menu entitled “**Save As.**” This menu allows you to navigate to the various fields in the Windows dialog without using a keyboard or mouse. The Tab and Arrow keys can also be used for dialog navigation.

See "[To File . . .](#)" on page 1349 in Save, State for a full description of this dialog and menu.

The default path for saving files is:

For all of the Trace Data Files:

My Documents\`<mode name>`\data\traces

For all of the Limit Data Files:

My Documents\`<mode name>`\data\limits

For all of the Measurement Results Data Files:

My Documents\`<mode name>`\data\`<measurement name>`\results

For all of the Capture Buffer Data Files:

My Documents\`<mode name>`\data\captureBuffer

Key Path	Save, Data
Mode	All
Notes	The key location is mode-dependent and will vary. Brings up the Save As dialog for saving a <code>&lt;mode specific&gt;</code> Save Type. The save is performed immediately and does not wait until the measurement is complete.
Initial S/W Revision	Prior to A.02.00

## Screen Image

Pressing Screen Image accesses a menu of functions that enable you to specify a format and location for the saved screen image. It brings up a menu that allows you to specify the color scheme of the Screen Image (Themes) or navigate to the Save As dialog to perform the actual save.

Screen Image files contain an exact representation of the analyzer display. They cannot be loaded back onto the analyzer, but they can be loaded into your PC for use in many popular applications.

The image to be saved is actually captured when the Save front panel key is pressed, and kept in temporary storage to be used if you ask for a Screen Image save. When the Screen Image key is pressed, a "thumbnail" of the captured image is displayed, as shown below:

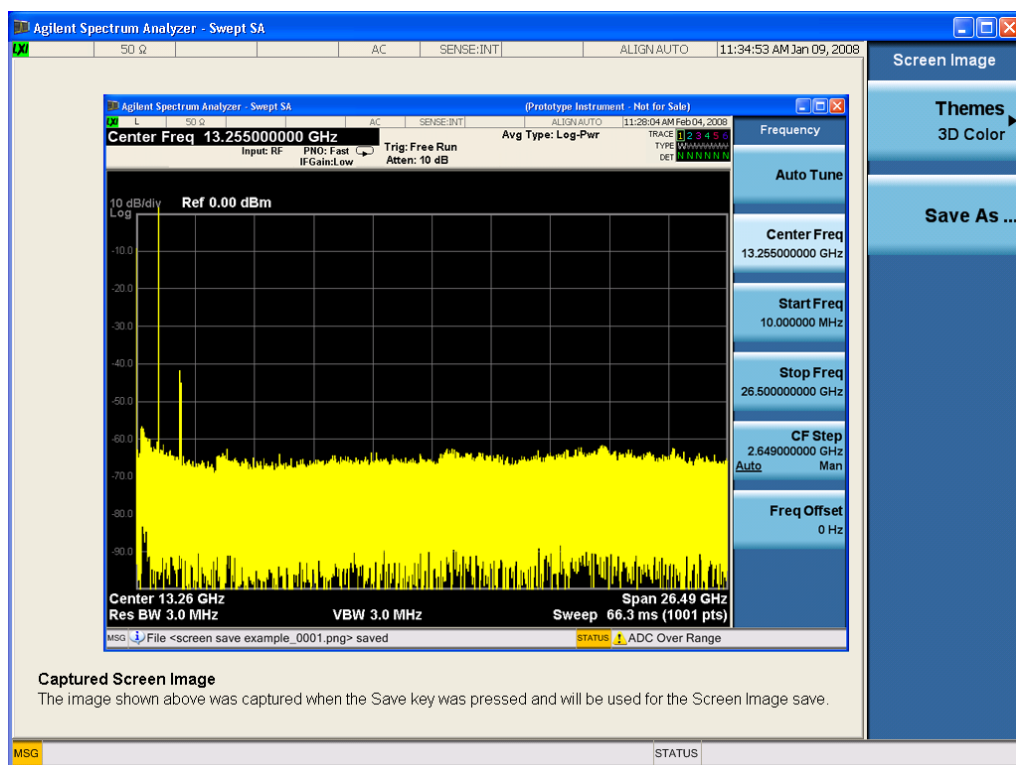

When you continue on into the Save As menu and complete the Screen Image save, the image depicted in the thumbnail is the one that gets saved, showing the menus that were on the screen before going into the Save menu. The save is performed immediately and does not wait until the measurement is complete.

After you have completed the save, the Quick Save front-panel key lets you quickly repeat the last save performed, using an auto-named file, with the current screen data.

### NOTE

For versions previous to A.01.55, if you initiate a screen image save by navigating through the Save menus, the image that is saved will contain the Save menu softkeys, not the menus and the active function that were on the screen when you first pressed the Save front panel key.

Key Path	Save
Mode	All

<b>Remote Command</b>	:MMEMory:STORe:SCReen <filename>
<b>Example</b>	:MMEM:STOR:SCR "myScreen.png" This stores the current screen image in the file MyScreenFile.png in the default directory.
Initial S/W Revision	Prior to A.02.00

## Themes

Accesses a menu of functions that enable you to choose the theme to be used when saving the screen image.

The **Themes** option is the same as the **Themes** option under the **Display** and **Page Setup** dialogs. It allows you to choose between themes to be used when saving the screen image.

<b>Key Path</b>	Save, Screen Image
<b>Remote Command</b>	:MMEMory:STORe:SCReen:THEMe TDColor   TDMonochrome   FCOLOR   FMONochrome :MMEMory:STORe:SCReen:THEMe?
<b>Example</b>	:MMEM:STOR:SCR:THEM TDM
Preset	3D Color; Is not part of Preset, but is reset by Restore Misc Defaults or Restore System Defaults All and survives subsequent running of the modes.
Readback	3D Color   3D Mono   Flat Color   Flat Mono
Backwards Compatibility Notes	In ESA and PSA we offer the choice of "Reverse Bitmap" or "Reverse Metafile" when saving screen images. This is much like the "Flat Color" theme available in X-Series. Also, if you selected Reverse Bitmap AND a black & white screen image, that would be much like "Flat Monochrome". In other words, each of the X-Series themes has a similar screen image type in ESA/PSA. But they are not identical.
Initial S/W Revision	Prior to A.02.00

## 3D Color

Selects a standard color theme with each object filled, shaded and colored as designed.

<b>Key Path</b>	Save, Screen Image, Themes
<b>Example</b>	MMEM:STOR:SCR:THEM TDC
Readback	3D Color
Initial S/W Revision	Prior to A.02.00

## 3D Monochrome

Selects a format that is like 3D color but shades of gray are used instead of colors.

Key Path	Save, Screen Image, Themes
<b>Example</b>	MMEM:STOR:SCR:THEM TDM
Readback	3D Mono
Initial S/W Revision	Prior to A.02.00

### Flat Color

Selects a format that is best when the screen is to be printed on an ink printer.

Key Path	Save, Screen Image, Themes
<b>Example</b>	MMEM:STOR:SCR:THEM FCOL
Readback	Flat Color
Initial S/W Revision	Prior to A.02.00

### Flat Monochrome

Selects a format that is like Flat Color. But only black is used (no colors, not even gray), and no fill.

Key Path	Save, Screen Image, Themes
<b>Example</b>	MMEM:STOR:SCR:THEM FMON
Readback	Flat Mono
Initial S/W Revision	Prior to A.02.00

### Save As...

When you press "Save As", the analyzer brings up a Windows dialog and a menu entitled "**Save As.**" This menu allows you to navigate to the various fields in the Windows dialog without using a keyboard or mouse. The Tab and Arrow keys can also be used for dialog navigation.

See "[To File . . .](#)" on page 1349 in Save, State for a full description of this dialog and menu.

The default path for Screen Images is

My Documents\`<mode name>`\screen.

where `<mode name>` is the parameter used to select the mode with the INST:SEL command (for example, SA for the Spectrum Analyzer).

Key Path	Save, Screen Image
Notes	Brings up Save As dialog for saving a Screen Image Save Type
Initial S/W Revision	Prior to A.02.00

## Single (Single Measurement/Sweep)

Sets the analyzer for Single measurement operation. The single/continuous state is Meas Global, so the setting will affect all the measurements. If you are Paused, pressing Single does a Resume.

See "[More Information](#)" on page 1377

Key Path	Front-panel key
Example	:INIT:CONT OFF
Notes	See Cont key description.
Backwards Compatibility Notes	<p>For Spectrum Analysis mode in ESA and PSA, the Single hardkey and the INITiate:IMM switched from continuous measurement to single measurement and restarted sweeps and averages (displayed average count reset to 1), but did not restart Max Hold and Min Hold. In the X-Series, the Single hardkey and the INITiate:IMM command initiate a sweep/ measurement/ average sequence/hold sequence including MaxHold and MinHold.</p> <p>For Spectrum Analysis mode in ESA and PSA, the Single hardkey restarted the sweep regardless of whether or not you were in an active sweep or sweep sequence. In the X-Series, Restart does this but Single only restarts the sweep or sweep sequence if you are in the idle state.</p> <p>INIT[:IMM] in ESA &amp; PSA Spectrum Analysis Mode does an implied ABORt. In some other PSA Modes, INIT[:IMM] is ignored if not in the idle state. . The X-Series follows the ESA/PSA SA Mode model, which may cause some Modes to have compatibility problems.</p>
Initial S/W Revision	Prior to A.02.00

### More Information

See "[Restart](#)" on page 1346 for details on the INIT:IMMEDIATE (Restart) function.

If you are already in single sweep, the INIT:CONT OFF command has no effect.

If you are already in Single Sweep, then pressing the Single key in the middle of a sweep does not restart the sweep or sequence. Similarly, pressing the Single key does not restart the sweep or sequence if the sweep is not in the idle state (for example, if you are taking a very slow sweep, or the analyzer is waiting for a trigger). Instead, it results in a message. "Already in Single, press Restart to initiate a new sweep or sequence". Even though pressing the Single key in the middle of a sweep does not restart the sweep, sending INIT:IMMEDIATE does reset it.

To take one more sweep without resetting the average count, increment the average count by 1, by pressing the step up key while **Average/Hold Number** is the active function, or sending the remote command CALC:AVER:TCON UP.

## Source

Opens a menu of keys that access various source configuration menus and settings. In the test set, pressing this key also causes the central view area to change and display the Source Control Main view.

Key Path	Front-panel key
----------	-----------------

## RF Output

This parameter sets the source RF power output state.

Key Path	Source
<b>Remote Command</b>	:OUTPut[:EXTErnal][:STATe] ON OFF 1 0 :OUTPut[:EXTErnal][:STATe]?
<b>Example</b>	OUTP OFF OUTP?
<b>Notes</b>	<p>The EXTErnal node is shown in RD text so the SCPI remains the same between internal and external source control. However, for EXT we do not wish to document this node to the customer since we are controlling the internal source rather than the external source.</p> <p>This setting is for the independent mode and has no effect on the <a href="#">"List Sequencer" on page 1449</a>. If the <a href="#">"Sequencer" on page 1449</a> is set to ON, the list sequencer controls the source output and this key will be grayed-out. And this setting will be none-forceful grey out on front panel to indicate out-of-scope. Non-forceful means user still can change this setting by SCPI but cannot change on front panel. When set to OFF will make source leave list sequencer and this setting will be black out and take effect immediately.</p> <p>When the RF Output is ON, an "RF" annunciator is displayed in the system settings panel. When the RF Output is turned Off, the RF annunciator is cleared. If the <a href="#">"Sequencer" on page 1449</a> is set to ON, the "RF" annunciator will be replaced by "SEQ" in the system settings panel, indicating that the output is controlled by the list sequencer.</p>
<b>Preset</b>	Off
<b>Range</b>	On   Off
<b>Initial S/W Revision</b>	A.05.00

## Amplitude

Allows you to access the Amplitude sub-menu.

Key Path	Source
<b>Notes</b>	<p>The sub-menu under this button is for independent mode and has no effect on <a href="#">"List Sequencer" on page 1449</a>. If the <a href="#">"Sequencer" on page 1449</a> is set to ON, the list sequencer controls the source output and this key will be grayed-out on front panel to indicate out-of-scope. When you set <a href="#">"Sequencer" on page 1449</a> to Off will make source leave list sequencer and this button will be black out.</p>
<b>Initial S/W Revision</b>	A.05.00

## RF Power

Allows you to adjust the power level of the source using the numeric keypad, step keys, or RPG. Pressing any digit, 0 through 9, on the numeric keypad brings up the unit terminator.

Please refer to the "RF Power Range " on page 1380 table below for the valid ranges.

Key Path	Source, Amplitude
Remote Command	:SOURce:POWer[:LEVel][:IMMediate][:AMPLitude] <ampl> :SOURce:POWer[:LEVel][:IMMediate][:AMPLitude]?
Example	:SOUR:POW -100 dBm
Notes	<p>Amplitude corrections can be specified for use with the source. In the event of amplitude corrections being applied, the valid ranges for the RF power do not change dependant on the current amplitude correction setting. If the combination of RF power + amplitude correction is higher or lower than the source output range, the Source Unleveled bit is set and the "Source Unleveled" indicator will appear on status panel to indicate that the source cannot maintain the output power that has been requested.</p> <p>When signal generator is unable to maintain the requested output level, the "Source Unleveled" indicator will appear on status panel. When the source output setting is restored to the normal range, the "Source Unleveled" is removed from status panel.</p> <p>Internal source has list sequence mode, which comprises of several steps which contain separate output power, frequency and waveform etc. When the source list sequence playing is complete, the last step keeps playing, and user can use this command to change the list sequence last step's output power.</p> <p>The multiport adapter RFIO TX ports and GPS ports cannot ensure power accuracy when power setting is lower than -130dBm, this power setting value is defined by the sum of RF Power setting and related amplitude correction value. But user settable value could be lower than this limit. When application detected there exists power setting lower than -130dBm on MPA RFIO TX ports, then popup warning message . When application detected there exists power setting lower than -130dBm on MPA GPS ports, then popup warning message . This is only warning message, and check is performed when RF is ON.</p>
Notes	The Min and Max value here defined UI settable amplitude range. This range is larger than actual amplitude range with level accuracy defined in spec.
Dependencies	The RF power is dependent on the RF output port and frequency, such that the current frequency and selected output port determine the valid range of power values.
Preset	-100 dBm
Min	The range of values depends on the current frequency and selected RF output port. Please refer to the "RF Power Range " on page 1380 table below for the valid ranges.
Max	The range of values depends on the current frequency and selected RF output port. Please refer to the "RF Power Range " on page 1380 table below for the valid ranges.
Initial S/W Revision	A.05.00

All other models:

### RF Power Range

RF Output Port	Frequency Range	Min Output Power	Max Output Power
High Power RF Out	10 MHz $\leq$ f $\leq$ 6 GHz	-150 dBm	20 dBm
RFIO 1 & RFIO 2	10 MHz $\leq$ f $\leq$ 6 GHz	-150 dBm	0 dBm
GPS (Note2)	10 MHz $\leq$ f $\leq$ 6 GHz	-150 dBm	0 dBm

Note: This is the UI power range, it's larger than actual spec.

Note2: GPS port is on the multiport adapter, or E6607C which has embedded MPA.

M9420A:

### RF Power Range

RF Output Port	Frequency Range	Min Output Power	Max Output Power without Option "1EA"	Max Output Power with Option "1EA"
RF Output	60 MHz $\leq$ f $\leq$ 6 GHz	-150 dBm	10 dBm	18 dBm
RFHD	60 MHz $\leq$ f $\leq$ 6 GHz	-150 dBm	10 dBm	15 dBm
RFFD	60 MHz $\leq$ f $\leq$ 6 GHz	-150 dBm	0 dBm	0 dBm

### Set Reference Power

This key allows you to set the power reference. Pressing this key turns the power reference state to ON, sets the reference power value to the current RF output power, maintains this power at the RF output, and sets the displayed power to 0.00 dB. All subsequent RF power values entered under Source>Amplitude>RF Power are interpreted as being relative to this reference power.

When you use a power reference, the signal generator outputs an RF power that is set relative to the reference power by the value entered under Source>Amplitude>RF Power as follows:

Output power = reference power – entered power

Where:

reference power equals the original RF Power entered under Source>Amplitude>RF Power and set as the reference power

entered power equals a new value entered under Source>Amplitude>Amptd Offset

In addition, the displayed power value is the same as a new value entered under Source>Amplitude>RF Power.

#### NOTE

If Power Ref is set to ON with a reference value set, entering a value under Source>Amplitude>RF Power and pressing Set Reference Power will add that value to the existing Power Ref value.

If you wish to change the reference power value to a new value entered under Source>Amplitude>RF Power, first you must set Power Ref to OFF and then press Set Reference Power.



Key Path	Source, Amplitude
Dependencies	This key is unavailable, and is grayed out when the <a href="#">"List Sequencer" on page 1449</a> is turned ON.
Initial S/W Revision	A.05.00

## Power Ref

This key allows you to toggle the state of the power reference.

When you use a power reference, the signal generator outputs an RF power that is set relative to the reference power by the value entered under Source>Amplitude>RF Power as follows:

Output power = reference power + entered power

Where:

reference power equals the original RF Power entered under Source>Amplitude>RF Power and set as the reference power

entered power equals a new value entered under Source>Amplitude>Amptd Offset

For more information on Reference Frequency refer to ["Set Reference Power " on page 1380](#)

Key Path	Source, Amplitude
<b>Remote Command</b>	:SOURce:POWer:REFeRence <ampl> :SOURce:POWer:REFeRence? :SOURce:POWer:REFeRence:STATe OFF ON 0 1 :SOURce:POWer:REFeRence:STATe?
<b>Example</b>	:SOUR:POW:REF 0.00 dBm :SOUR:POW:REF:STATe ON
Dependencies	This setting is unavailable and is grayed out when the <a href="#">"List Sequencer" on page 1449</a> is turned ON.
Couplings	This value is coupled to the <a href="#">"Set Reference Power " on page 1380</a> key such that pressing the Set Reference Power key updates the reference power with the current output power.
Preset	0.00 dBm OFF
Min	-125.00 dBm
Max	10.00 dBm
Initial S/W Revision	A.05.00

## Amptd Offset

Allows you to specify the RF output power offset value.

When the amplitude offset is set to zero (0) and you set a new offset value (positive or negative), the displayed amplitude value will change as follows and the RF output power will not change:

Displayed value = output power + offset value

Where:

output power equals the original RF Power entered under Source>Amplitude>RF Power

offset value equals the value entered under Source>Amplitude>Amptd Offset

When the amplitude offset is set to a value other than zero (0) and you enter a new RF power value under Source>Amplitude>RF Power, the displayed power will be the same as the value entered and the RF output power will be equal to the value entered minus the offset value as follows:

Output power = entered power – offset power

Displayed Power = output power + offset power

Displayed power = entered power

Where:

entered power equals the amplitude entered under Source>Amplitude>RF Power

offset power equals the value previously entered and set under Source>Amplitude>Amptd Offset

Key Path	Source, Amplitude
Remote Command	:SOURce:POWer[:LEVel][:IMMediate]:OFFSet <rel_ampl> :SOURce:POWer[:LEVel][:IMMediate]:OFFSet?
Example	:SOUR:POW:OFFS 0.00 dB
Dependencies	This setting is unavailable, and is grayed out when the List Sequencer is turned ON.
Preset	0.00 dB
Min	-200.00 dB
Max	200.00 dB
Initial S/W Revision	A.05.00

## Modulation

Allows you to toggle the state of the modulation.

Key Path	Source
Remote Command	:OUTPut:MODulation[:STATe] ON OFF 1 0 :OUTPut:MODulation[:STATe]?
Example	:OUTP:MOD OFF
Notes	This setting is for independent mode and has no effect on <a href="#">"List Sequencer" on page 1449</a> . If the <a href="#">"Sequencer" on page 1449</a> is set to ON, the list sequencer controls the source output and this key will be grayed-out. And this setting will be none-forceful grey out on front panel to indicate out-of-scope. Non-forceful means user still can change this setting by SCPI but cannot change manually on front panel. When set to Off will make source leave list sequencer and this setting will be black out and take effect immediately. When the Modulation is ON, the "MOD" annunciator is displayed in the system settings panel. When the Modulation is turned Off, the "MOD" annunciator is cleared. If the

"Sequencer" on page 1449 is set to ON, the "MOD" annunciator will be replaced by "SEQ" in the system settings panel indicating that the output is controlled by list sequencer.

Preset	Off
Range	On   Off
Initial S/W Revision	A.05.00

## Frequency

Allows you to access the Frequency sub-menu.

Key Path	Source
Notes	The sub-menu under this button is for independent mode and has no effect on "List Sequencer" on page 1449. If the "Sequencer" on page 1449 is set to ON, the list sequencer controls the source output and this key will be grayed-out. And this button will be grey out on front panel to indicate out-of-scope. When set to Off will make source leave list sequencer and this button will be black out.
Initial S/W Revision	A.05.00

## Frequency

Allows you to set the RF Output Frequency. You can adjust the frequency of the source using the numeric keypad, step keys, or RPG. Pressing any digit, 0 through 9, on the numeric keypad brings up the unit terminator.

Key Path	Source, Frequency
<b>Remote Command</b>	:SOURce:FREQuency[:CW] <freq> :SOURce:FREQuency[:CW]?
<b>Example</b>	:SOUR:FREQ 1.00 GHz
Notes	Internal source has list sequence mode, which comprises of several steps which contain separate output power, frequency and waveform etc. When the source list sequence playing is complete, the last step keeps playing, and user can use this command to change the list sequence last step's output frequency.
Couplings	The frequency value is coupled to the current channel band and number, such that updates to the band and number will update the frequency value to the corresponding absolute frequency.
Preset	1.00 GHz If license F1A or 5WC is present, the default Center Frequency should be 2.412GHz.
Min	10.00 MHz
Max	Hardware Dependant: Option 503 = 3.6 GHz Option 504 = 3.8 GHz Option 506 = 6.00 GHz For E6640A, if license 5WC is present, the frequency range should be limited to: 1.1GHz-1.7GHz,

2.4GHz–2.5GHz, 4.8GHz–6.0GHz. If the user-defined frequency is outside of range, UI will report an error message called “Settings conflict; Frequency is outside available range”.

Initial S/W Revision      A.05.00

## Channel

The frequency of the source can be specified by a channel number of a given frequency band. This key allows you to specify the current channel number. For the appropriate range of channel numbers for a given frequency band, refer to the following tables: ["GSM/EDGE Channel Number Ranges" on page 1384](#), ["W-CDMA Channel Number Ranges" on page 1385](#), ["CDMA 2000 / 1xEVDO Channel Number Ranges" on page 1387](#), and ["LTE FDD Channel Number Ranges" on page 1389](#).

Key Path	Source, Frequency
<b>Remote Command</b>	:SOURce:FREQuency:CHANnels:NUMBer <int> :SOURce:FREQuency:CHANnels:NUMBer?
<b>Example</b>	:SOUR:FREQ:CHAN:NUMB 1
Notes	This key is grayed out when the <a href="#">"Radio Standard" on page 1392</a> is set to NONE. This key is grayed out on E6630A.
Dependencies	This key is grayed out when the <a href="#">"Radio Standard" on page 1392</a> is set to NONE. This key is grayed out on E6630A.
Couplings	The channel number is coupled to the frequency value when the <a href="#">"Radio Standard" on page 1392</a> is not set to NONE. When the frequency value is changed, the channel number will increase or decrease to match the new frequency. If the frequency is not at an exact match for a channel number, the nearest channel number is displayed along with a greater than or less than sign to indicate the frequency is above or below the channel number.
Preset	1
Min	Please refer to the tables below for the valid ranges.
Max	Please refer to the tables below for the valid ranges.
Initial S/W Revision	A.05.00

## GSM/EDGE Channel Number Ranges

Band	Link (Device)	Range	Frequency (MHz)
P-GSM	Uplink (MS)	$1 \leq n \leq 124$	$890.0 + 0.2*n$
	Downlink (BS)	$1 \leq n \leq 124$	$935.0 + 0.2*n$
E-GSM	Uplink (MS)	$0 \leq n \leq 124$	$890.0 + 0.2*n$
		$975 \leq n \leq 1023$	$890.0 + 0.2*(n-1024)$
	Downlink (BS)	$0 \leq n \leq 124$	$935.0 + 0.2*n$
		$975 \leq n \leq 1023$	$935.0 + 0.2*(n-1024)$

Band	Link (Device)	Range	Frequency (MHz)
DCS 1800	Uplink (MS)	$512 \leq n \leq 885$	$1710.200 + 0.20*(n-512)$
	Downlink (BS)	$512 \leq n \leq 885$	$1805.200 + 0.20*(n-512)$
PCS 1900	Uplink (MS)	$512 \leq n \leq 810$	$1850.200 + 0.2*(n-512)$
	Downlink (BS)	$512 \leq n \leq 810$	$1930.200 + 0.2*(n-512)$
R-GSM	Uplink (MS)	$0 \leq n \leq 124$	$890.0 + 0.2*n$
		$955 \leq n \leq 1023$	$890.0 + 0.2*(n-1024)$
	Downlink (BS)	$0 \leq n \leq 124$	$935.0 + 0.2*n$
		$955 \leq n \leq 1023$	$935.0 + 0.2*(n-1024)$
GSM 450	Uplink (MS)	$256 \leq n \leq 293$	$450.6 + 0.2*(n-259)$
	Downlink (BS)	$256 \leq n \leq 293$	$460.6 + 0.2*(n-259)$
GSM 480	Uplink (MS)	$306 \leq n \leq 340$	$479.000 + 0.20*(n-306)$
	Downlink (BS)	$306 \leq n \leq 340$	$489.000 + 0.20*(n-306)$
GSM 850	Uplink (MS)	$128 \leq n \leq 251$	$824.200 + 0.20*(n-128)$
	Downlink (BS)	$128 \leq n \leq 251$	$869.200 + 0.20*(n-128)$
GSM 700	Uplink (MS)	$438 \leq n \leq 516$	$777.200 + 0.20*(n-438)$
	Downlink (BS)	$438 \leq n \leq 516$	$747.200 + 0.20*(n-438)$
T-GSM810	Uplink (MS)	$350 \leq n \leq 425$	$806.0 + 0.20*(n-350)$
	Downlink (BS)	$350 \leq n \leq 425$	$851.0 + 0.20*(n-350)$

### W-CDMA Channel Number Ranges

Band	Link (Device)	Range	Frequency (MHz)
Band I	Downlink	$10562 \leq n \leq 10838$	$n \div 5$
	Uplink	$9612 \leq n \leq 9888$	$n \div 5$
Band II	Downlink	$412 \leq n \leq 687$	$n \div 5 + 1850.1$
		$9662 \leq n \leq 9938$	$n \div 5$
	Uplink	$12 \leq n \leq 287$	$n \div 5 + 1850.1$
		$350 \leq n \leq 425$	$n \div 5$
Band III	Downlink	$1162 \leq n \leq 1513$	$n \div 5 + 1575$
	Uplink	$937 \leq n \leq 1288$	$n \div 5 + 1525$
Band IV	Downlink	$537 \leq n \leq 1738$	$n \div 5 + 1805$
		$1887 \leq n \leq 2087$	$n \div 5 + 1735.1$
	Uplink	$1312 \leq n \leq 1513$	$n \div 5 + 1450$
		$1662 \leq n \leq 1862$	$n \div 5 + 1380.1$
Band V	Downlink	$1007 \leq n \leq 1087$	$n \div 5 + 670.1$
		$4357 \leq n \leq 4458$	$n \div 5$

Band	Link (Device)	Range	Frequency (MHz)
	Uplink	$782 \leq n \leq 862$	$n \div 5 + 670.1$
		$4132 \leq n \leq 4233$	$n \div 5$
Band VI	Downlink	$1037 \leq n \leq 1062$	$n \div 5 + 670.1$
		$4387 \leq n \leq 4413$	$n \div 5$
	Uplink	$812 \leq n \leq 837$	$n \div 5 + 670.1$
		$4162 \leq n \leq 4188$	$n \div 5$
Band VII	Downlink	$2237 \leq n \leq 2563$	$n \div 5 + 2175$
		$2587 \leq n \leq 2912$	$n \div 5 + 2105.1$
	Uplink	$2012 \leq n \leq 2338$	$n \div 5 + 2100$
		$2362 \leq n \leq 2687$	$n \div 5 + 2030.1$
Band VIII	Downlink	$2937 \leq n \leq 3088$	$n \div 5 + 340$
	Uplink	$2712 \leq n \leq 2863$	$n \div 5 + 340$
Band IX	Downlink	$9237 \leq n \leq 9387$	$n \div 5$
	Uplink	$8762 \leq n \leq 8912$	$n \div 5$
Band X	Downlink	$3112 \leq n \leq 3388$	$n \div 5 + 1490$
		$3412 \leq n \leq 3687$	$n \div 5 + 1430.1$
	Uplink	$2887 \leq n \leq 3163$	$n \div 5 + 1135$
		$3187 \leq n \leq 3462$	$n \div 5 + 1075.1$
Band XI	Downlink	$3712 \leq n \leq 3812$	$n \div 5 + 736$
	Uplink	$3487 \leq n \leq 3587$	$n \div 5 + 733$
Band XII	Downlink	$3837 \leq n \leq 3903$	$n \div 5 - 37$
		$3927 \leq n \leq 3992$	$n \div 5 - 54.9$
	Uplink	$3612 \leq n \leq 3678$	$n \div 5 - 22$
		$3702 \leq n \leq 3767$	$n \div 5 - 39.9$
Band XIII	Downlink	$4017 \leq n \leq 4043$	$n \div 5 - 55$
		$4067 \leq n \leq 4092$	$n \div 5 - 64.9$
	Uplink	$3792 \leq n \leq 3818$	$n \div 5 + 21$
		$3702 \leq n \leq 3767$	$n \div 5 - 39.9$
Band XIV	Downlink	$4117 \leq n \leq 4143$	$n \div 5 - 63$
		$4167 \leq n \leq 4192$	$n \div 5 - 72.9$
	Uplink	$3892 \leq n \leq 3918$	$n \div 5 + 12$
		$3942 \leq n \leq 3967$	$n \div 5 + 2.1$
Band XIX	Downlink	$712 \leq n \leq 763$	$n \div 5 + 735$
		$787 \leq n \leq 837$	$n \div 5 + 720.1$
	Uplink	$312 \leq n \leq 363$	$n \div 5 + 770$
		$387 \leq n \leq 437$	$n \div 5 + 755.1$

## CDMA 2000 / 1xEVDO Channel Number Ranges

Band	Link (Device)	Range	Frequency (MHz)
US Cellular	Uplink (MS, reverse link)	$1 \leq N \leq 799$	$0.030 \times N + 825.000$
		$991 \leq N \leq 1023$	$0.030 \times (N - 1023) + 825.000$
		$1024 \leq N \leq 1323$	$0.030 \times (N - 1024) + 815.040$
	Downlink (BS, forward link)	$1 \leq N \leq 799$	$0.030 \times N + 870.000$
		$991 \leq N \leq 1023$	$0.030 \times (N - 1023) + 870.000$
		$1024 \leq N \leq 1323$	$0.030 \times (N - 1024) + 860.040$
US PCS	Uplink (MS, reverse link)	$0 \leq N \leq 1199$	$1850.000 + 0.050 \times N$
	Downlink (BS, forward link)	$0 \leq N \leq 1199$	$1930.000 + 0.050 \times N$
Japan Cellular Band	Uplink (MS, reverse link)	$1 \leq N \leq 799$	$0.0125 \times (N + 915.000)$
		$801 \leq N \leq 1039$	$0.0125 \times (N - 800) + 898.000$
		$1041 \leq N \leq 1199$	$0.0125 \times (N - 1040) + 887.000$
		$1201 \leq N \leq 1600$	$0.0125 \times (N - 1200) + 893.000$
	Downlink (BS, forward link)	$1 \leq N \leq 799$	$0.0125 \times (N + 860.000)$
		$801 \leq N \leq 1039$	$0.0125 \times (N - 800) + 843.000$
		$1041 \leq N \leq 1199$	$0.0125 \times (N - 1040) + 832.000$
		$1201 \leq N \leq 1600$	$0.0125 \times (N - 1200) + 838.000$
Korean PCS Band	Uplink (MS, reverse link)	$0 \leq N \leq 599$	$0.050 \times N + 1750.000$
	Downlink (BS, forward link)	$0 \leq N \leq 599$	$0.050 \times N + 1840.000$
NMT-450 Band	Uplink (MS, reverse link)	$1 \leq N \leq 400$	$0.025 \times (N - 1) + 450.000$
		$472 \leq N \leq 871$	$0.025 \times (N - 472) + 410.000$
		$1039 \leq N \leq 1473$	$0.020 \times (N - 1024) + 451.010$
		$1536 \leq N \leq 1715$	$0.025 \times (N - 1536) + 479.000$
		$1792 \leq N \leq 2016$	$0.020 \times (N - 1792) + 479.000$
	Downlink (BS, forward link)	$1 \leq N \leq 400$	$0.025 \times (N - 1) + 460.000$
		$472 \leq N \leq 871$	$0.025 \times (N - 472) + 420.000$
		$1039 \leq N \leq 1473$	$0.020 \times (N - 1024) + 461.010$
IMT-2000 Band	Uplink (MS, reverse link)	$0 \leq N \leq 1199$	$1920.000 + 0.050 \times N$
	Downlink (BS, forward link)	$0 \leq N \leq 1199$	$2100.000 + 0.050 \times N$
Upper 700 MHz Band	Uplink (MS, reverse link)	$0 \leq N \leq 240$	$776.000 + 0.050 \times N$
	Downlink (BS, forward link)	$0 \leq N \leq 240$	$746.000 + 0.050 \times N$

Band	Link (Device)	Range	Frequency (MHz)
	forward link)		
Secondary 800 MHz Band	Uplink (MS, reverse link)	$0 \leq N \leq 719$	$0.025 \times N + 806.000$
		$720 \leq N \leq 919$	$0.025 \times (N - 720) + 896.000$
	Downlink (BS, forward link)	$0 \leq N \leq 719$	$0.025 \times N + 851.000$
		$720 \leq N \leq 919$	$0.025 \times (N - 720) + 935.000$
2.5 GHz IMT Extension	Uplink (MS, reverse link)	$0 \leq N \leq 1399$	$2500.000 + 0.050 \times N$
	Downlink (BS, forward link)	$0 \leq N \leq 1399$	$2620.000 + 0.050 \times N$
US PCS 1.9 GHz	Uplink (MS, reverse link)	$0 \leq N \leq 1299$	$1850.000 + 0.050 \times N$
	Downlink (BS, forward link)	$0 \leq N \leq 1299$	$1930.000 + 0.050 \times N$
AWS	Uplink (MS, reverse link)	$0 \leq N \leq 899$	$1710.000 + 0.050 \times N$
	Downlink (BS, forward link)	$0 \leq N \leq 899$	$2100.000 + 0.050 \times N$
US 2.5 GHz	Uplink (MS, reverse link)	$140 \leq N \leq 1459$	$2495.000 + 0.050 \times N$
	Downlink (BS, forward link)	$140 \leq N \leq 1459$	$2617.000 + 0.050 \times N$
700 Public Safety	Uplink (MS, reverse link)	$0 \leq N \leq 240$	$787.000 + 0.050 \times N$
	Downlink (BS, forward link)	$0 \leq N \leq 240$	$757.000 + 0.050 \times N$
C2K Lower 700	Uplink (MS, reverse link)	$0 \leq N \leq 360$	$698.000 + 0.050 \times N$
	Downlink (BS, forward link)	$0 \leq N \leq 360$	$728.000 + 0.050 \times N$
400 Euro PAMR	Uplink (MS, reverse link)	$1 \leq N \leq 400$	$0.025 \times (N - 1) + 450.000$
		$472 \leq N \leq 871$	$0.025 \times (N - 472) + 410.000$
	Uplink (MS, reverse link)	$1536 \leq N \leq 1715$	$0.025 \times (N - 1536) + 479.000$
	Uplink (MS, reverse link)		
	Downlink (BS, forward link)	$1 \leq N \leq 400$	$0.025 \times (N - 1) + 460.000$
		$472 \leq N \leq 871$	$0.025 \times (N - 472) + 420.000$
	Downlink (BS, forward link)	$1536 \leq N \leq 1715$	$0.025 \times (N - 1536) + 489.000$
Downlink (BS, forward link)			



Band	Link (Device)	Range	Frequency (MHz)
800 PAMR	Uplink (MS, reverse link)	$0 \leq N \leq 239$	$870.0125 + 0.025 \times N$
	Downlink (BS, forward link)	$0 \leq N \leq 239$	$915.0125 + 0.025 \times N$

### LTE FDD Channel Number Ranges

The carrier frequency in the uplink and downlink is designated by the E-UTRA Absolute Radio Frequency Channel Number (EARFCN) in the range 0 – 65535. The relation between EARFCN and the carrier frequency in MHz for the downlink is given by the following equation, where FDL\_low and NOffs-DL are given in table 5.4.4–1 and NDL is the downlink EARFCN.

$$FDL = FDL\_low + 0.1(NDL - NOffs-DL)$$

The relation between EARFCN and the carrier frequency in MHz for the uplink is given by the following equation where FUL\_low and NOffs-UL are given in table 5.4.4–1 and NUL is the uplink EARFCN.

$$FUL = FUL\_low + 0.1(NUL - NOffs-UL)$$

Band	Downlink		Uplink			
	FDL_low (MHz)	NOffs-DL	Range of NDL	FUL_low (MHz)	NOffs-UL	Range of NUL
1		2110	0	0 – 599	1920	18000 – 18599
2		1930	600	600 – 1199	1850	18600 – 19199
3		1805	1200	1200 – 1949	1710	19200 – 19949
4		2110	1950	1950 – 2399	1710	19950 – 20399
5		869	2400	2400 – 2649	824	20400 – 20649
6		875	2650	2650 – 2749	830	20650 – 20749
7		2620	2750	2750 – 3449	2500	20750 – 20449
8		925	3450	3450 – 3799	880	21450 – 21799
9		1844.9	3800	3800 – 4149	1749.9	21800 – 22149
10		2110	4150	4150 – 4749	1710	22150 – 22749
11		1475.9	4750	4750 – 4949	1427.9	22750 – 22949

Band	Downlink	Uplink				
12	729	5010	5010 – 5179	699	23010	23010 – 23179
13	746	5180	5180 – 5279	777	23180	23180 – 23279
14	758	5280	5280 – 5379	788	23280	23280 – 23379
...						
17	734	5730	5730 – 5849	704	23730	23730 – 23849
18	860	5850	5850 – 5999	815	23850	23850 – 23999
19	875	6000	6000 – 6149	830	24000	24000 – 24149
20	791	6150	6150 – 6449	832	24150	24150 – 24449
21	1495.9	6450	6450 – 6599	1447.9	24450	24450 – 24599
...						
24	1525	7700	7700 – 8039	1626.5	25700	25700 – 26039
25	1930	8040	8040 – 8689	1850	26040	26040 – 26689
26	859	8690	8690 – 9039	814	26690	26690 – 27039
...						

Note: The channel numbers that designate carrier frequencies so close to the operating band edges that the carrier extends beyond the operating band edge shall not be used. This implies that the first 7, 15, 25, 50, 75 and 100 channel numbers at the lower operating band edge and the last 6, 14, 24, 49, 74 and 99 channel numbers at the upper operating band edge shall not be used for channel bandwidths of 1.4, 3, 5, 10, 15 and 20 MHz respectively.

### LTE TDD Channel Number Ranges

The carrier frequency in the uplink and downlink is designated by the E-UTRA Absolute Radio Frequency Channel Number (EARFCN) in the range 0 – 65535. The relation between EARFCN and the carrier frequency in MHz for the downlink is given by the following equation, where FDL\_low and NOffs-DL are given in table 5.4.4-1 and NDL is the downlink EARFCN.

$$FDL = FDL\_low + 0.1(NDL - NOffs-DL)$$

The relation between EARFCN and the carrier frequency in MHz for the uplink is given by the following equation where FUL\_low and NOffs-UL are given in table 5.4.4-1 and NUL is the uplink EARFCN.

$$FUL = FUL\_low + 0.1(NUL - NOffs-UL)$$

Band	Downlink		Uplink		
	NOffs-DL	Range of ND	FUL_low (MHz)	NOffs-UL	Range of NUL
33	1900	36000	36000 - 36199	1900	36000 - 36199
34	2010	36200	36200 - 36349	2010	36200 - 36349
35	1850	36350	36350 - 36949	1850	36350 - 36949
36	1930	36950	36950 - 37549	1930	36950 - 37549
37	1910	37550	37550 - 37749	1910	37550 - 37749
38	2570	37750	37750 - 38249	2570	37750 - 38249
39	1880	38250	38250 - 38649	1880	38250 - 38649
40	2300	38650	38650 - 39649	2300	38650 - 39649
41	2496	39650	39650 - 41589	2496	39650 - 41589
42	3400	41590	41590 - 43589	3400	41590 - 43589
43	3600	43590	43590 - 45589	3600	43590 - 45589

Note: The channel numbers that designate carrier frequencies so close to the operating band edges that the carrier extends beyond the operating band edge shall not be used. This implies that the first 7, 15, 25, 50, 75 and 100 channel numbers at the lower operating band edge and the last 6, 14, 24, 49, 74 and 99 channel numbers at the upper operating band edge shall not be used for channel bandwidths of 1.4, 3, 5, 10, 15 and 20 MHz respectively.

## TDSCDMA Channel Number Ranges

### 1.28 Mcps TDD Option

No TX-RX frequency separation is required as Time Division Duplex (TDD) is employed. Each subframe consists of 7 main timeslots where all main timeslots (at least the first one) before the single switching point are allocated DL and all main timeslots (at least the last one) after the single switching point are allocated UL.

The nominal channel spacing is 1.6 MHz, but this can be adjusted to optimise performance in a particular deployment scenario.

The carrier frequency is designated by the UTRA absolute radio frequency channel number (UARFCN). The value of the UARFCN in the IMT2000 band is defined in the general case as follows:

$$N_t = 5 * F \text{ 0.0 MHz } \leq F \leq 3276.6 \text{ MHz}$$

where F is the carrier frequency in MHz

Additional channels applicable to operation in the frequency band defined in sub-clause 5.2(d) are defined via the following UARFCN definition:

$$N_t = 5 * (F - 2150.1 \text{ MHz}) / 2572.5 \text{ MHz} \leq F \leq 2617.5 \text{ MHz}$$

UARFCN

1.28 Mcps TDD Option

The following UARFCN range shall be supported for each band:

**Table: UTRA Absolute Radio  
Frequency Channel Number 1.28  
Mcps TDD Option**

Frequency Band	Frequency Range	UARFCN Uplink and Downlink transmission
For operation in frequency band as defined in subclause 5.2 (a)	1900-1920 MHz	9504 to 9596
	2010-2025 MHz	10054 to 10121
For operation in frequency band as defined in subclause 5.2 (b)	1850-1910 MHz	9254 to 9546
	1930-1990 MHz	9654 to 9946
For operation in frequency band as defined in subclause 5.2 (c)	1910-1930 MHz	9554 to 9646
For operation in frequency band as defined in subclause 5.2 (d)	2570-2620 MHz	12854 to 13096
For operation in frequency band as defined in subclause 5.2 (e)	2300-2400 MHz	11504 to 11996
For operation in frequency band as defined in subclause 5.2 (f)	1880-1920 MHz	9404 to 9596

## Radio Setup

Allows access to the sub-menus for selecting the radio standard and associated radio band. You can also set a frequency reference and offset.

This menu is greyed out when on E6630A. Radio band settings for GSM, cdma2000, and so on -- most of which are not actually supported in E6630A, which has three narrow frequency bands. So band settings are grayed out.

Key Path	Source, Frequency
Initial S/W Revision	A.05.00

## Radio Standard

Allows access to the channel band sub-menus to select the desired radio standard. When you have selected the radio standard, you can then set an active channel band. The radio standard and the active

channel band allow you to use channel numbers to set frequency automatically.

Key Path	Source, Frequency, Radio Setup
<b>Remote Command</b>	:SOURce:FREQuency:CHANnels:BAND NONE   PGSM   EGSM   RGSM   DCS1800   PCS1900   TGSM810   GSM450   GSM480   GSM700   GSM850   BANDI   BANDII   BANDIII   BANDIV   BANDV   BANDVI   BANDVII   BANDVIII   BANDIX   BANDX   BANDXI   BANDXII   BANDXIII   BANDXIV   BANDXIX   USCELL   USPCS   JAPAN   KOREAN   NMT   IMT2K   UPPER   SECOND   PAMR400   PAMR800   IMTEXT   PCS1DOT9G   AWS   US2DOT5G   PUBLIC   LOWER   BAND1   BAND2   BAND3   BAND4   BAND5   BAND6   BAND7   BAND8   BAND10   BAND11   BAND12   BAND13   BAND14   BAND17   BAND18   BAND19   BAND20   BAND21   BAND24   BAND25   BAND26   BAND27   BAND28   BAND29   BAND30   BAND31   BAND33   BAND34   BAND35   BAND36   BAND37   BAND38   BAND39   BAND40   BAND41   BAND42   BAND43   BAND44   BANDA   BANDB   BANDC   BANDD   BANDE   BANDF  :SOURce:FREQuency:CHANnels:BAND?
<b>Example</b>	:SOUR:FREQ:CHAN:BAND PGSM
Notes	Set this setting to "NONE" will grey out "Channel" on page 1384 Channel
Initial S/W Revision	A.05.00

#### None

Selects no radio standard for use. When you have selected the radio standard to NONE, you cannot use channel numbers to set frequency automatically. You will need to set the frequency manually.

Key Path	Source, Frequency, Radio Setup, Radio Standard
Initial S/W Revision	A.05.00

#### GSM/EDGE

Sets GSM/EDGE as the radio standard for use and accesses the GSM/EDGE specific channel band sub-menus.

Key Path	Source, Frequency, Radio Setup, Radio Standard
Initial S/W Revision	A.05.00

#### P-GSM

Selects P-GSM as the active channel band.

Key Path	Source, Frequency, Radio Setup, Radio Standard, GSM/EDGE
<b>Example</b>	:SOUR:FREQ:CHAN:BAND PGSM
Initial S/W Revision	A.05.00

### E-GSM

Selects E-GSM as the active channel band.

Key Path	Source, Frequency, Radio Setup, Radio Standard, GSM/EDGE
<b>Example</b>	:SOUR:FREQ:CHAN:BAND EGSM
Initial S/W Revision	A.05.00

### R-GSM

Selects R-GSM as the active channel band.

Key Path	Source, Frequency, Radio Setup, Radio Standard, GSM/EDGE
<b>Example</b>	:SOUR:FREQ:CHAN:BAND RGSM
Initial S/W Revision	A.05.00

### DCS 1800

Selects DCS 1800 as the active channel band.

Key Path	Source, Frequency, Radio Setup, Radio Standard, GSM/EDGE
<b>Example</b>	:SOUR:FREQ:CHAN:BAND DCS1800
Initial S/W Revision	A.05.00

### PCS 1900

Selects PCS 1900 as the active channel band.

Key Path	Source, Frequency, Radio Setup, Radio Standard, GSM/EDGE
<b>Example</b>	:SOUR:FREQ:CHAN:BAND PCS1900
Initial S/W Revision	A.05.00

### GSM 450

Selects GSM 450 as the active channel band.

Key Path	Source, Frequency, Radio Setup, Radio Standard, GSM/EDGE
<b>Example</b>	:SOUR:FREQ:CHAN:BAND GSM450
Initial S/W Revision	A.05.00

**GSM 480**

Selects GSM 480 as the active channel band.

Key Path	Source, Frequency, Radio Setup, Radio Standard, GSM/EDGE
<b>Example</b>	:SOUR:FREQ:CHAN:BAND GSM480
Initial S/W Revision	A.05.00

**GSM 850**

Selects GSM 850 as the active channel band.

Key Path	Source, Frequency, Radio Setup, Radio Standard, GSM/EDGE
<b>Example</b>	:SOUR:FREQ:CHAN:BAND GSM850
Initial S/W Revision	A.05.00

**GSM 700**

Selects GSM 700 as the active channel band.

Key Path	Source, Frequency, Radio Setup, Radio Standard, GSM/EDGE
<b>Example</b>	:SOUR:FREQ:CHAN:BAND GSM700
Initial S/W Revision	A.05.00

**T-GSM 810**

Selects T-GSM 810 as the active channel band.

Key Path	Source, Frequency, Radio Setup, Radio Standard, GSM/EDGE
<b>Example</b>	:SOUR:FREQ:CHAN:BAND T-GSM810
Initial S/W Revision	A.05.00

**WCDMA**

Sets WCDMA as the radio standard for use and accesses the W-CDMA specific channel band sub-menus.

Key Path	Source, Frequency, Radio Setup, Radio Standard
Initial S/W Revision	A.05.00

**Band I**

Selects Band I as the active channel band.

---

Key Path	Source, Frequency, Radio Setup, Radio Standard, WCDMA
<b>Example</b>	:SOUR:FREQ:CHAN:BAND BANDI
Initial S/W Revision	A.05.00

---

#### Band II

Selects Band II as the active channel band.

---

Key Path	Source, Frequency, Radio Setup, Radio Standard, WCDMA
<b>Example</b>	:SOUR:FREQ:CHAN:BAND BANDII
Initial S/W Revision	A.05.00

---

#### Band III

Selects Band III as the active channel band.

---

Key Path	Source, Frequency, Radio Setup, Radio Standard, WCDMA
<b>Example</b>	:SOUR:FREQ:CHAN:BAND BANDIII
Initial S/W Revision	A.05.00

---

#### Band IV

Selects Band IV as the active channel band.

---

Key Path	Source, Frequency, Radio Setup, Radio Standard, WCDMA
<b>Example</b>	:SOUR:FREQ:CHAN:BAND BANDIV
Initial S/W Revision	A.05.00

---

#### Band V

Selects Band V as the active channel band.

---

Key Path	Source, Frequency, Radio Setup, Radio Standard, WCDMA
<b>Example</b>	:SOUR:FREQ:CHAN:BAND BANDV
Initial S/W Revision	A.05.00

---

#### Band VI

Selects Band VI as the active channel band.



Key Path	Source, Frequency, Radio Setup, Radio Standard, WCDMA
<b>Example</b>	:SOUR:FREQ:CHAN:BAND BANDVI
Initial S/W Revision	A.05.00

**Band VII**

Selects Band VII as the active channel band.

Key Path	Source, Frequency, Radio Setup, Radio Standard, WCDMA
<b>Example</b>	:SOUR:FREQ:CHAN:BAND BANDVII
Initial S/W Revision	A.05.00

**Band VIII**

Selects Band VIII as the active channel band.

Key Path	Source, Frequency, Radio Setup, Radio Standard, WCDMA
<b>Example</b>	:SOUR:FREQ:CHAN:BAND BANDVIII
Initial S/W Revision	A.05.00

**Band IX**

Selects Band IX as the active channel band.

Key Path	Source, Frequency, Radio Setup, Radio Standard, WCDMA
<b>Example</b>	:SOUR:FREQ:CHAN:BAND BANDIX
Initial S/W Revision	A.05.00

**Band X**

Selects Band X as the active channel band.

Key Path	Source, Frequency, Radio Setup, Radio Standard, WCDMA
<b>Example</b>	:SOUR:FREQ:CHAN:BAND BANDX
Initial S/W Revision	A.05.00

**Band XI**

Selects Band XI as the active channel band.

---

Key Path	Source, Frequency, Radio Setup, Radio Standard, WCDMA
<b>Example</b>	:SOUR:FREQ:CHAN:BAND BANDXI
Initial S/W Revision	A.05.00

---

#### Band XII

Selects Band XII as the active channel band.

---

Key Path	Source, Frequency, Radio Setup, Radio Standard, WCDMA
<b>Example</b>	:SOUR:FREQ:CHAN:BAND BANDXII
Initial S/W Revision	A.05.00

---

#### Band XIII

Selects band XIII as the active channel band.

---

Key Path	Source, Frequency, Radio Setup, Radio Standard, WCDMA
<b>Example</b>	:SOUR:FREQ:CHAN:BAND BANDXIII
Initial S/W Revision	A.05.00

---

#### Band XIV

Selects Band XIV as the active channel band.

---

Key Path	Source, Frequency, Radio Setup, Radio Standard, WCDMA
<b>Example</b>	:SOUR:FREQ:CHAN:BAND BANDXIV
Initial S/W Revision	A.05.00

---

#### LTE

Sets LTE FDD as the radio standard for use and accesses the LTE FDD specific channel band sub-menus..

---

Key Path	Source, Frequency, Radio Setup, Radio Standard
Initial S/W Revision	A.09.50

---

#### BAND 1

Selects BAND 1 as the band for the current step.

---

Key Path	Source, Frequency, Radio Setup, Radio Standard, LTE
----------	-----------------------------------------------------

---

<b>Example</b>	:SOUR:FREQ:CHAN:BAND BAND1
Initial S/W Revision	A.09.50

**BAND 2**

Selects BAND 2 as the band for the current step.

Key Path	Source, Frequency, Radio Setup, Radio Standard, LTE
<b>Example</b>	:SOUR:FREQ:CHAN:BAND BAND2
Initial S/W Revision	A.09.50

**BAND 3**

Selects BAND 3 as the band for the current step.

Key Path	Source, Frequency, Radio Setup, Radio Standard, LTE
<b>Example</b>	:SOUR:FREQ:CHAN:BAND BAND3
Initial S/W Revision	A.09.50

**BAND 4**

Selects BAND 4 as the band for the current step.

Key Path	Source, Frequency, Radio Setup, Radio Standard, LTE
<b>Example</b>	:SOUR:FREQ:CHAN:BAND BAND4
Initial S/W Revision	A.09.50

**BAND 5**

Selects BAND 5 as the band for the current step.

Key Path	Source, Frequency, Radio Setup, Radio Standard, LTE
<b>Example</b>	:SOUR:FREQ:CHAN:BAND BAND5
Initial S/W Revision	A.09.50

**BAND 6**

Selects BAND 6 as the band for the current step.

Key Path	Source, Frequency, Radio Setup, Radio Standard, LTE
----------	-----------------------------------------------------

---

<b>Example</b>	:SOUR:FREQ:CHAN:BAND BAND6
Initial S/W Revision	A.09.50

---

#### BAND 7

Selects BAND 7 as the band for the current step.

---

Key Path	Source, Frequency, Radio Setup, Radio Standard, LTE
<b>Example</b>	:SOUR:FREQ:CHAN:BAND BAND7
Initial S/W Revision	A.09.50

---

#### BAND 8

Selects BAND 8 as the band for the current step.

---

Key Path	Source, Frequency, Radio Setup, Radio Standard, LTE
<b>Example</b>	:SOUR:FREQ:CHAN:BAND BAND8
Initial S/W Revision	A.09.50

---

#### BAND 9

Selects BAND 9 as the band for the current step.

---

Key Path	Source, Frequency, Radio Setup, Radio Standard, LTE
<b>Example</b>	:SOUR:FREQ:CHAN:BAND BAND9
Initial S/W Revision	A.09.50

---

#### BAND 10

Selects BAND 10 as the band for the current step.

---

Key Path	Source, Frequency, Radio Setup, Radio Standard, LTE
<b>Example</b>	:SOUR:FREQ:CHAN:BAND BAND10
Initial S/W Revision	A.09.50

---

#### BAND 11

Selects BAND 11 as the band for the current step.

---

Key Path	Source, Frequency, Radio Setup, Radio Standard, LTE
----------	-----------------------------------------------------

---

<b>Example</b>	:SOUR:FREQ:CHAN:BAND BAND11
Initial S/W Revision	A.09.50

**BAND 12**

Selects BAND 12 as the band for the current step.

Key Path	Source, Frequency, Radio Setup, Radio Standard, LTE
<b>Example</b>	:SOUR:FREQ:CHAN:BAND BAND12
Initial S/W Revision	A.09.50

**BAND 13**

Selects BAND 13 as the band for the current step.

Key Path	Source, Frequency, Radio Setup, Radio Standard, LTE
<b>Example</b>	:SOUR:FREQ:CHAN:BAND BAND13
Initial S/W Revision	A.09.50

**BAND 14**

Selects BAND 14 as the band for the current step.

Key Path	Source, Frequency, Radio Setup, Radio Standard, LTE
<b>Example</b>	:SOUR:FREQ:CHAN:BAND BAND14
Initial S/W Revision	A.09.50

**BAND 17**

Selects BAND 17 as the band for the current step.

Key Path	Source, Frequency, Radio Setup, Radio Standard, LTE
<b>Example</b>	:SOUR:FREQ:CHAN:BAND BAND17
Initial S/W Revision	A.09.50

**BAND 18**

Selects BAND 18 as the band for the current step.

Key Path	Source, Frequency, Radio Setup, Radio Standard, LTE
----------	-----------------------------------------------------

---

<b>Example</b>	:SOUR:FREQ:CHAN:BAND BAND18
Initial S/W Revision	A.09.50

---

#### BAND 19

Selects BAND 19 as the band for the current step.

---

Key Path	Source, Frequency, Radio Setup, Radio Standard, LTE
<b>Example</b>	:SOUR:FREQ:CHAN:BAND BAND19
Initial S/W Revision	A.09.50

---

#### BAND 20

Selects BAND 20 as the band for the current step.

---

Key Path	Source, Frequency, Radio Setup, Radio Standard, LTE
<b>Example</b>	:SOUR:FREQ:CHAN:BAND BAND20
Initial S/W Revision	A.09.50

---

#### BAND 21

Selects BAND 21 as the band for the current step.

---

Key Path	Source, Frequency, Radio Setup, Radio Standard, LTE
<b>Example</b>	:SOUR:FREQ:CHAN:BAND BAND21
Initial S/W Revision	A.09.50

---

#### BAND 24

Selects BAND 24 as the band for the current step.

---

Key Path	Source, Frequency, Radio Setup, Radio Standard, LTE
<b>Example</b>	:SOUR:FREQ:CHAN:BAND BAND24
Initial S/W Revision	A.09.50

---

#### BAND 25

Selects BAND 25 as the band for the current step.

---

Key Path	Source, Frequency, Radio Setup, Radio Standard, LTE
----------	-----------------------------------------------------

---

<b>Example</b>	:SOUR:FREQ:CHAN:BAND BAND25
Initial S/W Revision	A.09.50

**BAND 26**

Selects BAND 26 as the band for the current step.

Key Path	Source, Frequency, Radio Setup, Radio Standard, LTE
<b>Example</b>	:SOUR:FREQ:CHAN:BAND BAND26
Initial S/W Revision	A.12.53

**BAND 27**

Selects BAND 27 as the band for the current step.

Key Path	Source, Frequency, Radio Setup, Radio Standard, LTE
<b>Example</b>	:SOUR:FREQ:CHAN:BAND BAND27
Initial S/W Revision	A.14.00

**BAND 28**

Selects BAND 28 as the band for the current step.

Key Path	Source, Frequency, Radio Setup, Radio Standard, LTE
<b>Example</b>	:SOUR:FREQ:CHAN:BAND BAND28
Initial S/W Revision	A.14.00

**BAND 31**

Selects BAND 31 as the band for the current step.

Key Path	Source, Frequency, Radio Setup, Radio Standard, LTE
<b>Example</b>	:SOUR:FREQ:CHAN:BAND BAND31
Initial S/W Revision	A.14.00

**LTE TDD**

Sets LTE TDD as the radio standard for use and accesses the LTE TDD specific channel band sub-menus..

Key Path	Source, Frequency, Radio Setup, Radio Standard
Initial S/W Revision	A.11.50

### BAND 33

Selects BAND 33 as the band for the current step.

Key Path	Source, Frequency, Radio Setup, Radio Standard, LTE TDD
<b>Example</b>	:SOUR:FREQ:CHAN:BAND BAND33
Initial S/W Revision	A.11.50

### BAND 34

Selects BAND 34 as the band for the current step.

Key Path	Source, Frequency, Radio Setup, Radio Standard, LTE TDD
<b>Example</b>	:SOUR:FREQ:CHAN:BAND BAND34
Initial S/W Revision	A.11.50

### BAND 35

Selects BAND 35 as the band for the current step.

Key Path	Source, Frequency, Radio Setup, Radio Standard, LTE TDD
<b>Example</b>	:SOUR:FREQ:CHAN:BAND BAND35
Initial S/W Revision	A.11.50

### BAND 36

Selects BAND 36 as the band for the current step.

Key Path	Source, Frequency, Radio Setup, Radio Standard, LTE TDD
<b>Example</b>	:SOUR:FREQ:CHAN:BAND BAND36
Initial S/W Revision	A.11.50

### BAND 37

Selects BAND 37 as the band for the current step.

Key Path	Source, Frequency, Radio Setup, Radio Standard, LTE TDD
<b>Example</b>	:SOUR:FREQ:CHAN:BAND BAND37
Initial S/W Revision	A.11.50



**BAND 38**

Selects BAND 38 as the band for the current step.

Key Path	Source, Frequency, Radio Setup, Radio Standard, LTE TDD
<b>Example</b>	:SOUR:FREQ:CHAN:BAND BAND38
Initial S/W Revision	A.11.50

**BAND 39**

Selects BAND 39 as the band for the current step.

Key Path	Source, Frequency, Radio Setup, Radio Standard, LTE TDD
<b>Example</b>	:SOUR:FREQ:CHAN:BAND BAND39
Initial S/W Revision	A.11.50

**BAND 40**

Selects BAND 40 as the band for the current step.

Key Path	Source, Frequency, Radio Setup, Radio Standard, LTE TDD
<b>Example</b>	:SOUR:FREQ:CHAN:BAND BAND40
Initial S/W Revision	A.11.50

**BAND 41**

Selects BAND 41 as the band for the current step.

Key Path	Source, Frequency, Radio Setup, Radio Standard, LTE TDD
<b>Example</b>	:SOUR:FREQ:CHAN:BAND BAND41
Initial S/W Revision	A.11.50

**BAND 42**

Selects BAND 42 as the band for the current step.

Key Path	Source, Frequency, Radio Setup, Radio Standard, LTE TDD
<b>Example</b>	:SOUR:FREQ:CHAN:BAND BAND42
Initial S/W Revision	A.11.50

### BAND 43

Selects BAND 43 as the band for the current step.

Key Path	Source, Frequency, Radio Setup, Radio Standard, LTE TDD
<b>Example</b>	:SOUR:FREQ:CHAN:BAND BAND43
Initial S/W Revision	A.11.50

### BAND 44

Selects BAND 44 as the band for the current step.

Key Path	Source, Frequency, Radio Setup, Radio Standard, LTE TDD
<b>Example</b>	:SOUR:FREQ:CHAN:BAND BAND44
Initial S/W Revision	A.14.00

### TDSCDMA

Sets TDSCDMA as the radio standard for use and accesses the TDSCDMA specific channel band sub-menus..

Key Path	Source, Frequency, Radio Setup, Radio Standard
Initial S/W Revision	A.11.50

### BAND A

Selects BAND A as the band for the current step.

Key Path	Source, Frequency, Radio Setup, Radio Standard, TDSCDMA
<b>Example</b>	:SOUR:FREQ:CHAN:BAND BANDA
Initial S/W Revision	A.11.50

### BAND B

Selects BAND B as the band for the current step.

Key Path	Source, Frequency, Radio Setup, Radio Standard, TDSCDMA
<b>Example</b>	:SOUR:FREQ:CHAN:BAND BANDB
Initial S/W Revision	A.11.50

### BAND C

Selects BAND C as the band for the current step.

Key Path	Source, Frequency, Radio Setup, Radio Standard, TDSCDMA
<b>Example</b>	:SOUR:FREQ:CHAN:BAND BANDC
Initial S/W Revision	A.11.50

#### BAND D

Selects BAND D as the band for the current step.

Key Path	Source, Frequency, Radio Setup, Radio Standard, TDSCDMA
<b>Example</b>	:SOUR:FREQ:CHAN:BAND BANDD
Initial S/W Revision	A.11.50

#### BAND E

Selects BAND E as the band for the current step.

Key Path	Source, Frequency, Radio Setup, Radio Standard, TDSCDMA
<b>Example</b>	:SOUR:FREQ:CHAN:BAND BANDE
Initial S/W Revision	A.11.50

#### BAND F

Selects BAND F as the band for the current step.

Key Path	Source, Frequency, Radio Setup, Radio Standard, TDSCDMA
<b>Example</b>	:SOUR:FREQ:CHAN:BAND BANDF
Initial S/W Revision	A.11.50

#### Radio Band Link

Allows you to specify the channel band type as either uplink or downlink link direction. This value is used in conjunction with the channel band and channel number to determine the absolute frequency output by the source. When set to “Uplink”, the source will calculate the uplink frequency using an uplink formula together with the selected channel band and channel number . When set to “Downlink”, the source will calculate the downlink frequency using a downlink formula together with the selected channel band and channel number.

Key Path	Source, Frequency, Radio Setup
<b>Remote Command</b>	:SOURce:RADio:BAND:LINK DOWN UP :SOURce:RADio:BAND:LINK?

<b>Example</b>	:SOUR:RAD:BAND:LINK UP
<b>Preset</b>	DOWN
<b>Range</b>	DOWN   UP
<b>Backwards Compatibility SCPI</b>	:SOURce:RADio:DEVIce BTS MS :SOURce:RADio:DEVIce?
<b>Backwards Compatibility Notes</b>	BTS maps to the Downlink frequency MS maps to the Uplink frequency
<b>Initial S/W Revision</b>	A.05.00

### Set Reference Frequency

This key allows you to set the frequency reference. Pressing this key turns the frequency reference state to ON, sets the reference frequency value to the current frequency, maintains this frequency at the RF output, and sets the displayed frequency to 0.00 Hz. All subsequent frequencies entered under Source>Frequency>Frequency are interpreted as being relative to this reference frequency.

When you use a frequency reference, the signal generator outputs a frequency that is set relative to the reference frequency by the value entered under Source>Frequency>Frequency as follows:

Output frequency = reference frequency - entered frequency

Where:

reference frequency equals the original RF frequency entered under Source>Frequency>Frequency and set as the reference frequency

entered frequency equals a new value entered under Source>Frequency>Frequency

In addition, the displayed frequency value will be the same as the value entered under Source>Frequency>Frequency.

**NOTE**

If Freq Reference is set to ON with a reference value set, entering a value under Source>Frequency>Frequency and pressing Set Frequency Reference will add that value to the existing Freq Reference value.

If you wish to change the reference frequency value to the new value entered under Source>Frequency>Frequency, first you must set Freq Reference to OFF and then press Set Frequency Reference.

<b>Key Path</b>	Source, Frequency
<b>Remote Command</b>	:SOURce:FREQuency:REFerence:SET
<b>Example</b>	:SOUR:FREQ:REF:SET
<b>Dependencies</b>	This setting is unavailable, and is grayed out when the List Sequencer is turned ON.
<b>Initial S/W Revision</b>	A.05.00

## Freq Reference

This key allows you to toggle the state of the frequency reference. When the frequency reference state is ON, an annunciator is displayed on the main source view to indicate this state to the user.

When you use a frequency reference, the signal generator outputs a frequency that is set relative to the reference frequency by the value entered under Source>Frequency>Frequency as follows:

Output frequency = reference frequency + entered frequency

Where:

reference frequency equals the original RF frequency entered under Source>Frequency>Frequency and set as the reference frequency

entered frequency equals a new value entered under Source>Frequency>Frequency

For more information on Reference Frequency refer to ["Set Reference Frequency" on page 1408](#)

Key Path	Source, Frequency
<b>Remote Command</b>	:SOURce:FREQuency:REFerence <freq> :SOURce:FREQuency:REFerence? :SOURce:FREQuency:REFerence:STATe OFF ON 0 1 :SOURce:FREQuency:REFerence:STATe?
<b>Example</b>	:SOUR:FREQ:REF 0.00 Hz :SOUR:FREQ:REF:STATe ON
Dependencies	This setting is unavailable, and is grayed out when the List Sequencer is turned ON.
Couplings	The frequency reference state is coupled to the frequency reference set immediate action. When the reference set immediate action key is pressed, or the SCPI command issued, it turns the frequency reference state ON.
Preset	0.00 Hz OFF
Min	0.00 Hz
Max	Hardware Dependant: Option 503 = 3.6 GHz Option 504 = 3.8 GHz Option 506 = 6.00 GHz
Initial S/W Revision	A.05.00

## Freq Offset

Allows you to specify the frequency offset value. When the frequency offset state is ON, an annunciator is displayed on the main source view to indicate this state to the user.

When the frequency offset is set to zero (0) and you set a new offset value, the displayed frequency value will change as follows and the RF output frequency will not change:

Displayed value = output frequency + offset value

Where:

output frequency equals the original frequency entered under Source>Frequency>Frequency

offset value equals the value entered under Source>Frequency>Freq Offset

When the frequency offset is set to a value other than zero (0) and you enter a new frequency value under Source>Frequency>Frequency, the displayed frequency will be the same as the value entered and the RF output frequency will be equal to the value entered minus the offset value as follows:

Output frequency = entered frequency – offset frequency

Displayed frequency = output frequency + offset frequency

Displayed frequency = entered frequency

Where:

entered frequency equals the frequency entered under Source>Frequency>Frequency

offset frequency equals the value previously entered and set under Source>Frequency>Freq Offset

Key Path	Source, Frequency
Remote Command	:SOURce:FREQuency:OFFSet <freq> :SOURce:FREQuency:OFFSet?
Example	:SOUR:FREQ:OFFS 0 Hz
Dependencies	This setting is unavailable, and is grayed out when the List Sequencer is turned ON.
Preset	0 Hz
Min	-100.00 GHz
Max	100.00 GHz
Initial S/W Revision	A.05.00

## Modulation Setup

Allows access to the menus for setting up the available modulation types: "ARB" on page 1424, "AM" on page 1445, "FM" on page 1446, and "PM" on page 1448.

Key Path	Source
Initial S/W Revision	A.05.00

## ARB

Allows you access to the ARB sub-menus.

Key Path	Source, Modulation Setup
Initial S/W Revision	A.05.00

## ARB

Allows you to toggle the state of the ARB function. When the ARB is On, a “MOD” annunciator is displayed in the system settings panel. When the ARB is turned Off, the MOD annunciator is cleared

Key Path	Source, Modulation Setup, ARB
Remote Command	:SOURce:RADio:ARB[:STATe] ON OFF 1 0 :SOURce:RADio:ARB[:STATe]?
Example	:SOUR:RAD:ARB OFF :SOUR:RAD:ARB?
Notes	If the ARB is ON, a user then loads or deletes another file to ARB memory, the playing waveform segment may not keep phase continuity during the ARB memory operation. The waveform will be replayed after the ARB operation is finished.
Dependencies	This setting is for independent mode and has no effect on 3.3.8 list sequencer mode. Setting <b>"Sequencer" on page 1449</b> Sequencer to On will put source enter list sequencer mode, and even if ARB state is On, the ARB file will not be played. Setting <b>"Sequencer" on page 1449</b> Sequencer to Off will make source leave list sequencer mode, and this setting will take effect immediately. The ARB can only be turned on when there is a waveform file selected for playback. On the GUI If no waveform is selected, this key is grayed out. If you send the SCPI command to turn the ARB on with no waveform selected for playback, the ARB state remains OFF and an error is generated. "- When you try to recall a certain set of states in which the selected waveform is not in ARB memory and the ARB state is On, errors are reported
Preset	Off
Range	On   Off
Initial S/W Revision	A.05.00

## Select Waveform

Allows you to access to the waveform selection sub-menus.

Pressing this key changes the central view area to show the Waveform File Selection view.

Key Path	Source, Modulation Setup, ARB
Initial S/W Revision	A.05.00

## Select Waveform

Allows you to select a waveform sequence or segment for the dual ARB to play.

NOTE: Selecting a waveform file does not result in automatic adjustments to burst timing (to compensate for the presence or absence of a Multiport Adapter); that adjustment occurs only when a waveform is loaded to ARB memory. See "Load Segment to ARB Memory" for more information about this adjustment.

<b>Key Path</b>	Source, Modulation Setup, ARB, Select Waveform
<b>Remote Command</b>	:SOURCE:RADio:ARB:WAVEform <string> :SOURCE:RADio:ARB:WAVEform?
<b>Example</b>	:SOUR:RAD:ARB:WAV "test_waveform.bin"
<b>Notes</b>	<p>If intended waveform is not in the memory yet, then issuing this command by SCPI will invoke ARB loading operation first, which involves a delay of unpredictable length. So this command should be followed by the query *OPC?, which holds off subsequent commands until the loading operation is complete.</p> <p>&lt;string&gt; - specifies the name of the waveform segment or waveform sequence to be played by the ARB.</p> <p>When in Sequence Analyzer mode, and Include Source is Yes, if the you attempt to play a waveform sequence but not all the required waveform segments are in the ARB playback memory, the application will reject the loading operation with an error is generated .</p> <p>When Include Source is No, if you attempt to play a waveform sequence but not all the required waveform segments are contained in the ARB playback memory, the application will attempt to load the required segments from either the default directory of the current directory. If the ARB memory does not have enough space for all the waveform segments to be loaded, an error is generated and none of the waveform segments is loaded.</p> <p>If the ARB is ON, and you attempt to play a waveform sequence but not all the waveform segments within the sequence could be found to be loaded into ARB memory, an error is generated. The selected waveform keeps the previous value and ARB state remains On.</p> <p>If you specify a waveform segment over SCPI but the waveform segment is not present within ARB playback memory and cannot be found for auto loading within the current directory or the default directory, an error is generated and the file selection remains unchanged.</p> <p>If you select a waveform for playback and the waveform requires a license that is not installed on the instrument, an error is generated. error is generated.</p> <p>If the ARB is ON and you load a file to ARB memory or delete a file from ARB memory, the playing waveform segment may not keep phase continuity during the ARB memory operation. The waveform will be replayed after the ARB operation is finished.</p>
<b>Initial S/W Revision</b>	A.05.00

### Segments on Hard Disk

Allows you access to the sub-menus for loading waveform segments from the hard disk into ARB memory. The default directory is: D: varb.

Pressing this key changes the current view to the Waveform Management View.

<b>Key Path</b>	Source, Modulation Setup, ARB, Select Waveform
<b>Initial S/W Revision</b>	A.05.00

### Load Segment To ARB Memory

Allows you to load the selected file into ARB memory. On the front panel you select the file for loading to the ARB memory by highlighting the desired file in the list. Using the SCPI command, you specify the file



name on the HDD.

“NVWFM” (none-volatile storage) MSUS (Mass Storage Unit Specifier) is supported in the memory subsystem because the ARB memory cannot be accessed directly. Therefore, files must be downloaded to the instrument hard disk and then loaded into the ARB memory. “NVWFM” MSUS will be mapped to the default directory D: VARB. The SCPI command supports using either “NVWFM” MSUS or specifying a full path. For more information, see Memory Subsystem (Remote Command Only).

If a file of the same name already exists within ARB memory, it is overwritten. If you wish to load two segments of the same name, you must rename one of the segments before loading it into ARB memory. To rename a segment, you can either use Windows File Explorer, or the :MMEMory:COPI command.

NOTE: When a waveform file is loaded to ARB memory, burst timing adjustments are made automatically, based on whether or not a Multiport Adapter is connected to the test set and powered on. If the connection/power status of the Multiport Adapter is changed after a waveform file has been loaded, it needs to be loaded again.

<b>Key Path</b>	Source, Modulation Setup, ARB, Select Waveform, Segments on Hard Disk
<b>Remote Command</b>	:SOURce:RADio:ARB:LOAD <string>
<b>Example</b>	:SOUR:RAD:ARB:LOAD "D: VARB\testwaveform.bin" or :SOUR:RAD:ARB:LOAD "NVWFM:testwaveform.bin"
<b>Notes</b>	<p>Because loading the file involves a delay of unpredictable length, this command should be followed by the query *OPC?, which holds off subsequent commands until the loading operating is complete.</p> <p>&lt;string&gt; – specifies the path name of the file to load from the HDD into ARB memory. It could be a &lt;full path + filename&gt;, or &lt;“NVWFM” MSUS + colon + filename&gt;.</p> <p>When in Sequence Analyzer mode, and Include Source is Yes, an attempt to load a file to ARB memory will be rejected with an error.</p> <p>When Include Source is No and if there is insufficient free ARB memory to load the selected waveform, an error is generated. .</p> <p>If you specify a file over SCPI, but the file is not at the specified location, an error is generated.</p> <p>If you try to load a waveform file but the file contains less than 500 IQ samples, an error is generated.</p> <p>If you try to load a Signal Studio waveform “*.wfm” which contains invalid waveform header, an error is generated.</p> <p>If the ARB is ON when you load a file to ARB memory or delete a file from ARB memory, the playing waveform segment may not keep phase continuity during the ARB memory operation. The waveform will be replayed after the ARB operation is finished.</p> <p>ARB can be loaded into ARB memory even required licenses do not present on the instrument. In this case, a GUI only warning message -800, “Operation complete; Loaded &lt;filename&gt; successfully, but no license &lt;required licenses&gt; installed”. User can install required licenses according to &lt;required licenses&gt; string to license it, or multi-pack license it.</p>
<b>Initial S/W Revision</b>	A.05.00

### Load All To ARB Memory

Allows you to load all the segment files within the currently selected directory into ARB memory. If a file of the same name already exists within ARB memory, it is overwritten. If you wish to load two segments of the

same name, you must rename one of the segments before loading it into ARB memory. To rename a segment, you can either use Windows File Explorer, or the :MEMory:COpy command.

NOTE: When a waveform file is loaded to ARB memory, burst timing adjustments are made automatically, based on whether or not a Multiport Adapter is connected to the test set and powered on. If the connection/power status of the Multiport Adapter is changed after a waveform file has been loaded, it needs to be loaded again.

<b>Key Path</b>	Source, Modulation Setup, ARB, Select Waveform, Segments on Hard Disk
<b>Remote Command</b>	:SOURce:RADio:ARB:LOAD:ALL <string>
<b>Example</b>	:SOUR:RAD:ARB:LOAD:ALL "D: varb"
<b>Notes</b>	<p>&lt;string&gt; - specifies the directory on the HDD to load the files into ARB memory from.</p> <p>When in Sequence Analyzer mode, and Include Source is Yes, an attempt to load all files from a directory to ARB memory is rejected with an error.</p> <p>When Include Source is No and there is insufficient free ARB memory to load all the waveforms, when the ARB memory is full, the copy ceases, and an error is generated.</p> <p>If you specify a directory over SCPI, but the directory does not exist, an error is generated.</p> <p>If the ARB is ON, a user then loads or deletes file to ARB memory, the playing waveform segment may not keep phase continuity during the ARB memory operation. The waveform will be replayed after the ARB operation is finished.</p>
<b>Initial S/W Revision</b>	A.05.00

#### Change Directory...

Allows you to change the currently selected directory on the hard disk. Pressing this key opens a standard windows change directory dialog allowing you to select the new directory of interest.

The current directory is used for manually loading waveform segments into ARB memory for playback, and as a search location for waveform segments that are required to be loaded into ARB memory for playback of a waveform sequence or a list sequence.

<b>Key Path</b>	Source, Modulation Setup, ARB, Select Waveform, Segments on Hard Disk
<b>Notes</b>	No remote command, SCPIfront panel only.
<b>Initial S/W Revision</b>	A.05.00

#### Default Directory...

Allows you to change the default directory. It is used as a search location for waveform segments that are required to be loaded into ARB memory for playback of a waveform sequence, and as a search location for selecting waveforms using SCPI.

<b>Key Path</b>	Source, Modulation Setup, ARB, Select Waveform, Segments on Hard Disk
<b>Remote Command</b>	:SOURce:RADio:ARB:DEFault:DIRectory <string> :SOURce:RADio:ARB: DEFault:DIRectory?
<b>Example</b>	:SOUR:RAD:ARB:DEF:DIR "D:\ArbFiles"

	:SOUR:RAD:ARB:DEF:DIR?
State Saved	Persistent, survives a power cycle and a preset but not saved in the instrument state
Initial S/W Revision	A.05.00

### Segments in ARB Memory

Allows you access to the sub-menus for managing the files within ARB memory.

Key Path	Source, Modulation Setup, ARB, Select Waveform
Initial S/W Revision	A.05.00

### Delete Segment From ARB Mem

Allows you to remove a segment from ARB playback memory.

Key Path	Source, Modulation Setup, ARB, Select Waveform, Segments in ARB Memory
<b>Remote Command</b>	:SOURce:RADio:ARB:DELeTe <string>
<b>Example</b>	:SOUR:RAD:ARB:DEL "testwaveform.bin"
Notes	<p>&lt;string&gt; - specifies the waveform to be deleted from the ARB playback memory.</p> <p>When in Sequence Analyzer mode and Include Source is Yes, an attempt to delete a file from ARB memory is rejected with an error.</p> <p>When Include Source is No and you specify a file that does not exist within ARB memory, an error is generated.</p> <p>It is possible to delete files from within the ARB memory when the ARB is ON. However, if you attempt to delete the file that is currently playing an error is generated.</p> <p>It is possible to delete a file from within the ARB memory when the sequencer state is ON and the file is not being used by the List Sequencer. If you attempt to delete a file which is being used by the list sequencer, an error is generated.</p> <p>When sequencer state is On, even if ARB state is On, the selected waveform will not be played. In this case, if the selected waveform is not used in List Sequence, it can be deleted and the ARB state is turned Off.</p> <p>If the ARB is ON and you load a file to ARB memory or delete a file from ARB memory, the playing waveform segment may not keep phase continuity during the ARB memory operation. The waveform will be replayed after the ARB operation is finished.</p>
Initial S/W Revision	A.05.00

### Delete All From ARB Memory

Allows you to remove all segments from ARB playback memory.

Key Path	Source, Modulation Setup, ARB, Select Waveform, Segments in ARB Memory
----------	------------------------------------------------------------------------

<b>Remote Command</b>	:SOURce:RADio:ARB:DELeTe:ALL
<b>Example</b>	:SOUR:RAD:ARB:DELeTe:ALL
<b>Notes</b>	<p>When in Sequence Analyzer mode and Include Source is Yes, an attempt to delete all files from ARB memory is rejected with an error.</p> <p>When Include Source is No and you attempt to delete all files from ARB memory when the ARB is currently playing a file, all files except the one playing are deleted and an error is generated.</p> <p>If you attempt to delete all files from ARB memory when there are waveform files used in "List Sequencer" on page 1449 and "Sequencer" on page 1449 state is ON, all files except the files currently being used in list sequencer are deleted, and an error is generated.</p> <p>If the ARB is ON and you load a file to ARB memory or delete a file from ARB memory, the playing waveform segment may not keep phase continuity during the ARB memory operation. The waveform will be replayed after the ARB operation is finished.</p>
<b>Initial S/W Revision</b>	A.05.00

### ARB Setup

Allows access to the ARB setup sub-menus.

<b>Key Path</b>	Source, Modulation Setup, ARB
<b>Initial S/W Revision</b>	A.05.00

### Sample Rate

Allows you to set the ARB waveform playback sample rate.

<b>Key Path</b>	Source, Modulation Setup, ARB, ARB Setup
<b>Remote Command</b>	:SOURce:RADio:ARB:SCLock:RATE <freq> :SOURce:RADio:ARB:SCLock:RATE?
<b>Example</b>	:SOUR:RAD:ARB:SCL:RATE 48.00 MHz
<b>Notes</b>	If there is a sample rate specified in the header of the waveform file, changing that sample rate is not recommended, as it may cause problems with burst timing.
<b>Dependencies</b>	When a new waveform is selected for playback the settings contained within the associated waveform header file are applied to the ARB. The sample rate is one of the values stored within the header file. If the newly selected waveform file has an associated header file, the sample rate is updated with the value from the header file. The sample rate will remain unchanged if the newly selected waveform does not have an associated header file.
<b>Preset</b>	125.00 MHz
<b>Min</b>	1.00 kHz
<b>Max</b>	125.00 MHz
<b>Initial S/W Revision</b>	A.05.00

### Run-Time Scaling

Allows you to adjust the run-time scaling value. The run-time scaling value is applied in real-time while the waveform is playing.

<b>Key Path</b>	Source, Modulation Setup, ARB, ARB Setup
<b>Remote Command</b>	:SOURce:RADio:ARB:RSCaling <real> :SOURce:RADio:ARB:RSCaling?
<b>Example</b>	:SOUR:RAD:ARB:RSC 100.00
<b>Notes</b>	This setting cannot be set in E6640A/M9420A. Grey out on menu and the value is fixed at 70.00%.
<b>Dependencies</b>	When a new waveform is selected for playback the settings contained within the associated waveform header file are applied to the ARB. The run-time scaling is one of the values stored within the header file. If the newly selected waveform file has an associated header file, the run-time scaling is updated with the value from the header file. The run-time scaling will remain unchanged if the newly selected waveform does not have an associated header file.
<b>Preset</b>	70.00 %
<b>Min</b>	1.00 %
<b>Max</b>	100.00 %
<b>Initial S/W Revision</b>	A.05.00

### Baseband Freq Offset

Allows you to adjust the value by which the baseband frequency is offset relative to the carrier.

<b>Key Path</b>	Source, Modulation Setup, ARB, ARB Setup
<b>Remote Command</b>	:SOURce:RADio:ARB:BASEband:FREQuency:OFFSet <freq> :SOURce:RADio:ARB:BASEband:FREQuency:OFFSet?
<b>Example</b>	:SOUR:RAD:ARB:BAS:FREQ:OFFS 0.00 Hz
<b>Dependencies</b>	When a new waveform is selected for playback the settings contained within the associated waveform header file are applied to the ARB. The baseband frequency offset is one of the values stored within the header file. If the newly selected waveform file has an associated header file, the baseband frequency offset is updated with the value from the header file. The baseband frequency offset will remain unchanged if the newly selected waveform does not have an associated header file.
<b>Preset</b>	0.00 Hz
<b>Min</b>	-50.00 MHz
<b>Max</b>	50.00 MHz
<b>Initial S/W Revision</b>	A.05.00

### Edit RMS

Allows you to edit or calculate current RMS of selected waveform.

Key Path	Source, Modulation Setup, ARB, ARB Setup
Initial S/W Revision	A.14.50

### Current RMS

Allows you to directly specify current RMS value used to playback currently selected waveform. Please note incorrect RMS value may cause inaccurate power output in E6640A/M9420A that is sensitive to RMS value.

This setting is also updated by RMS in waveform header or updated when invoking RMS calculation operation.

This setting can be saved to the header of currently selected waveform by invoking ["Save Setup To Header" on page 1445](#) "Save Setup To Header".

Key Path	Source, Modulation Setup, ARB, ARB Setup, Edit RMS
Remote Command	:SOURce:RADio:ARB:RMS <float> :SOURce:RADio:ARB:RMS?
Example	:SOUR:RAD:ARB:HEAD:RMS 0.7 :SOUR:RAD:ARB:HEAD:RMS?
Notes	Valid range is 0 to 1.414, values outside the range will be clipped to the closest boundary. Note this value does not affect <a href="#">"List Sequencer" on page 1449</a> Source List Sequencer that always uses RMS value resides in each ARB header. If want this value to take effect in list sequencer, use <a href="#">"Save Setup To Header" on page 1445</a> "Save Setup to Header" to save current RMS value to header first, then play the ARB in source list sequencer.
Dependencies	When a new waveform is selected for playback, this setting is updated by the RMS value defined in associated waveform header file. If selected waveform has no associated header file or header file does not specify RMS value, then instrument will try to calculate out one automatically. Calculating RMS can also update this setting.
Preset	0
Range	0 ~ 1.414
Initial S/W Revision	A.14.50

### RMS Calculation Mode

Allows you to specify the mode to calculate the current RMS.

Key Path	Source, Modulation Setup, ARB, ARB Setup, Edit RMS
Remote Command	:SOURce:RADio:ARB:RMS:CALCulation:MODE AUTO   M1   M2   M3   M4 :SOURce:RADio:ARB:RMS:CALCulation:MODE?
Example	:SOUR:RAD:ARB:RMS:CALC:MODE AUTO
Notes	If no waveform is selected, or selected waveform is waveform sequence, the key will grey out.

Preset	AUTO
Range	AUTO   M1   M2   M3   M4
Initial S/W Revision	A.14.50

### Auto

RMS will be calculated based on the whole sample range of current selected waveform.

Key Path	Source, Modulation Setup, ARB, ARB Setup, Edit RMS, Calculate RMS, RMS Calculation Mode
<b>Example</b>	:SOUR:RAD:ARB:RMS:CALC:MODE AUTO
Initial S/W Revision	A.14.50

### Marker 1

Selects marker 1 to designate sample range used for RMS calculation.

Key Path	Source, Modulation Setup, ARB, ARB Setup, Edit RMS, Calculate RMS, RMS Calculation Mode , Marker
<b>Example</b>	:SOUR:RAD:ARB:RMS:CALC:MODE M1
Initial S/W Revision	A.14.50

### Marker 2

Selects marker 2 to designate sample range used for RMS calculation.

Key Path	Source, Modulation Setup, ARB, ARB Setup, Edit RMS, Calculate RMS, RMS Calculation Mode , Marker
<b>Example</b>	:SOUR:RAD:ARB:RMS:CALC:MODE M2
Initial S/W Revision	A.14.50

### Marker 3

Selects marker 3 to designate sample range used for RMS calculation.

Key Path	Source, Modulation Setup, ARB, ARB Setup, Edit RMS, Calculate RMS, RMS Calculation Mode , Marker
<b>Example</b>	:SOUR:RAD:ARB:RMS:CALC:MODE M3
Initial S/W Revision	A.14.50

#### Marker 4

Selects marker 4 to designate sample range used for RMS calculation.

Key Path	Source, Modulation Setup, ARB, ARB Setup, Edit RMS, Calculate RMS, RMS Calculation Mode , Marker
<b>Example</b>	:SOUR:RAD:ARB:RMS:CALC:MODE M4
Initial S/W Revision	A.14.50

#### Calculate RMS

Allows you to calculate current RMS based on mode selected. This will update "[Current RMS](#)" on page 1418 Current RMS setting.

Key Path	Source, Modulation Setup, ARB, ARB Setup, Edit RMS, Calculate RMS
<b>Remote Command</b>	:SOURce:RADio:ARB:RMS:CALCulate
<b>Example</b>	:SOUR:RAD:ARB:RMS:CALC
Notes	<p>If no waveform is selected, invoking this operation will get error “-221 Setting conflict; No waveform is selected for RMS operation”.</p> <p>If no waveform is selected, or selected waveform is waveform sequence, the key will grey out.</p> <p>If selected waveform does not contain marker data, but "<a href="#">RMS Calculation Mode</a>" on page 1418 “RMS Calculation Mode” is set to marker, under this circumstance, invoking calculation operation will get error “-221 Setting conflict; There is no marker for currently selected waveform, auto RMS calculation mode is used instead”, and "<a href="#">RMS Calculation Mode</a>" on page 1418 “RMS Calculation Mode” will be coupled to “Auto” mode automatically.</p> <p>RMS calculation does not suit for waveform sequence. If selected waveform is waveform sequence file, invoking this operation will get error “-221 Setting conflict; RMS calculation does not apply to waveform sequence”. But users can still edit current RMS as play parameter, and can save current RMS to waveform sequence header for later use.</p>
Initial S/W Revision	A.14.50

#### Use Header RMS

Allows you to quickly set RMS in ARB header to "[Current RMS](#)" on page 1418 Current RMS setting.

Key Path	Source, Modulation Setup, ARB, ARB Setup, Edit RMS,
Notes	<p>No remote command, front panel only.</p> <p>If no waveform is selected, the key will grey out.</p> <p>If no waveform is selected, invoking this operation will get error “-221 Setting conflict; No waveform is selected for RMS operation”.</p>
Initial S/W Revision	A.14.50



## Trigger Type

Allows access to the trigger type sub-menus. The setting for trigger type determines the behavior of the waveform when it plays.

Key Path	Source, Modulation Setup, ARB
Remote Command	:SOURce:RADio:ARB:TRIGger:TYPE CONTinuous   SINGLE   SADVance :SOURce:RADio:ARB:TRIGger:TYPE?
Example	:SOUR:RAD:ARB:TRIG:TYPE CONT :SOUR:RAD:ARB:TRIG:TYPE?
Notes	Gated trigger type will be implemented at a later release
Preset	CONTinuous
Range	Continuous   Single   Seg Adv
Initial S/W Revision	A.05.00

### Continuous

Sets the active trigger type to Continuous. If Continuous is already selected as the active trigger type, pressing this key allows access to the continuous trigger type setup menu. In Continuous trigger mode, the waveform repeats continuously.

Key Path	Source, Modulation Setup, ARB, Trigger Type
Remote Command	:SOURce:RADio:ARB:TRIGger:TYPE:CONTinuous[:TYPE] FREE   TRIGger   RESet :SOURce:RADio:ARB:TRIGger:TYPE:CONTinuous[:TYPE]?
Example	:SOUR:RAD:ARB:TRIG:TYPE:CONT FREE
Preset	FREE
Range	Free Run   Trigger + Run   Reset + Run
Initial S/W Revision	A.05.00

### Free Run

Selects Free Run as the trigger response for the continuous trigger type. Free Run sets the waveform generator to play a waveform sequence or segment continuously, without waiting for a trigger. In this mode, the waveform generator does not respond to triggers.

Key Path	Source, Modulation Setup, ARB, Trigger Type, Continuous
Example	:SOUR:RAD:ARB:TRIG:TYPE:CONT FREE
Initial S/W Revision	A.05.00

### Trigger + Run

Sets Trigger and Run as the trigger response for the continuous trigger type. Trigger and Run sets the waveform generator to play a waveform sequence or segment continuously when the first trigger is received, and to ignore any subsequent triggers.

Key Path	Source, Modulation Setup, ARB, Trigger Type, Continuous
<b>Example</b>	:SOUR:RAD:ARB:TRIG:TYPE:CONT TRIG
Initial S/W Revision	A.05.00

### Reset + Run

Sets Reset and Run as the trigger response for the continuous trigger type. Reset and Run sets the waveform generator to play a waveform sequence or segment continuously when the first trigger is received. Subsequent triggers reset the waveform sequence or segment to the start, and then play it continuously.

Key Path	Source, Modulation Setup, ARB, Trigger Type, Continuous
<b>Example</b>	:SOUR:RAD:ARB:TRIG:TYPE:CONT RES
Initial S/W Revision	A.05.00

### Single

Sets the active trigger type to Single. If Single is already selected as the active trigger type, pressing this key allows access to the single trigger type setup menu. In Single trigger mode, the waveform plays once.

Key Path	Source, Modulation Setup, ARB, Trigger Type
<b>Remote Command</b>	:SOURce:RADio:ARB:RETRigger ON OFF IMMediate :SOURce:RADio:ARB:RETRigger?
<b>Example</b>	:SOUR:RAD:ARB:RETR OFF
Notes	ON: Buffered Trigger OFF: No Retrigger Immediate: Restart on Trigger This is defined as an enumerated SCPI command, with ON OFF being considered as enumerated types rather than Boolean. This means the query will return OFF instead of 0, and ON instead of 1.
Preset	ON
Range	No Retrigger   Buffered Trigger   Restart on Trigger
Initial S/W Revision	A.05.00

### No Retrigger

Selects No Retrigger as the trigger response for single trigger type. No Retrigger sets the waveform generator to play a waveform sequence or segment once when a trigger is received. Any triggers then

received during playback are ignored.

<b>Key Path</b>	Source, Modulation Setup, ARB, Trigger Type, Single
<b>Example</b>	:SOUR:RAD:ARB:RETR OFF
<b>Initial S/W Revision</b>	A.05.00

### Buffered Trigger

Selects Buffered Trigger as the trigger response for single trigger type. Buffered Trigger sets the waveform generator to play a waveform sequence or segment once when a trigger is received. If a trigger is received during playback, the waveform generator plays the sequence or segment to the end, then plays the sequence or segment once more.

<b>Key Path</b>	Source, Modulation Setup, ARB, Trigger Type, Single
<b>Example</b>	:SOUR:RAD:ARB:RETR ON
<b>Initial S/W Revision</b>	A.05.00

### Restart on Trigger

Selects Restart on Trigger as the trigger response for single trigger type. Restart on Trigger sets the waveform generator to play a waveform sequence or segment once when a trigger is received. If a trigger is received during playback, the waveform generator resets and plays the sequence or segment from the start.

<b>Key Path</b>	Source, Modulation Setup, ARB, Trigger Type, Single
<b>Example</b>	:SOUR:RAD:ARB:RETR IMM
<b>Initial S/W Revision</b>	A.05.00

### Segment Advance

Sets the active trigger type to Segment Advance. If Segment Advance is already selected as the active trigger type, pressing this key allows access to the segment advance trigger type setup menu.

Segment Advance triggering allows you to control the playback of waveform segments within a waveform sequence. When a trigger is received the ARB advances to the next waveform segment within the waveform sequence. This type of triggering ignores the repetition count for the waveform segment within the waveform sequence. For example, if a waveform segment has a repetition count of 10 and you select single segment advance triggering mode, the waveform segment will only play once.

Segment Advance triggering can also be used for waveform segments only. In this situation the same waveform segment is played again when a trigger is received.

<b>Key Path</b>	Source, Modulation Setup, ARB, Trigger Type
<b>Remote Command</b>	:SOURce:RADio:ARB:TRIGger:TYPE:SADvance[:TYPE] SINGLE   CONTinuous

	:SOURce:RADio:ARB:TRIGger:TYPE:SADVance[:TYPE]?
<b>Example</b>	:SOUR:RAD:ARB:TRIG:TYPE:SADV SING
Preset	CONTInuous
Range	Single   Continuous
Initial S/W Revision	A.05.00

### Single

Selects Single as the trigger response for Segment Advance trigger type. With single selected, once a trigger is received a segment is played once. If a trigger is received during playback of a segment, the segment plays to completion and the next segment is played once.

Key Path	Source, Modulation Setup, ARB, Trigger Type, Segment Advance
<b>Example</b>	:SOUR:RAD:ARB:TRIG:TYPE:SADV SING
Initial S/W Revision	A.05.00

### Continuous

Selects Continuous as the trigger response for Segment Advance trigger type. With continuous selected, once a trigger is received a segment is played continuously. When subsequent triggers are received, the currently playing segment plays to completion and then the next segment is played continuously.

Key Path	Source, Modulation Setup, ARB, Trigger Type, Segment Advance
<b>Example</b>	:SOUR:RAD:ARB:TRIG:TYPE:SADV CONT
Initial S/W Revision	A.05.00

### ARB

Allows you access to the ARB sub-menus.

Key Path	Source, Modulation Setup
Initial S/W Revision	A.05.00

### Trigger Source

The trigger source setting determines how the source receives the trigger that starts the waveform playing. Therefore, this key is grayed out if the trigger type is free run, since free run triggers immediately with no trigger source required.

Key Path	Source, Modulation Setup, ARB
<b>Remote Command</b>	:SOURce:RADio:ARB:TRIGger[:SOURce] KEY BUS EXTernal2

	:SOURce:RADio:ARB:TRIGger[:SOURce]?
<b>Example</b>	:SOUR:RAD:ARB:TRIGger KEY
Dependencies	This key is grayed out if the current trigger type is Continuous, Free Run.
Preset	EXTernal2
Range	Trigger Key   Bus   External 2
Initial S/W Revision	A.05.00

### Trigger Key

Sets the current trigger source to the front panel Trigger key. When Trigger Key is selected, the waveform is triggered when you press the front panel Trigger key.

Key Path	Source, Modulation Setup, ARB, Trigger Source
<b>Example</b>	:SOUR:RAD:ARB:TRIGger KEY
Initial S/W Revision	A.05.00

### Bus

Sets the current trigger source to Bus. Selecting Bus trigger source enables triggering over GPIB, LAN, or USB using the :SOURce:RADio:ARB:TRIGger:INITiate command.

Key Path	Source, Modulation Setup, ARB, Trigger Source
<b>Example</b>	:SOUR:RAD:ARB:TRIGger BUS
Initial S/W Revision	A.05.00

### External 2

Sets the current trigger source to External 2. Selecting External 2 enables triggering a waveform by an externally applied signal.

Key Path	Source, Modulation Setup, ARB, Trigger Source
<b>Example</b>	:SOUR:RAD:ARB:TRIGger EXT2
Notes	Note: When on E6640A, trigger 2 is a bi-directional trigger port. So when trigger 2 has been configured as OUTPUT type, choosing External 2 as the input trigger for the current step will generate error.
Initial S/W Revision	A.05.00

### External Trigger Delay

This key allows you to toggle the state and value of external trigger delay. The value you enter sets a delay time between when an external trigger is received and when it is applied to the waveform. This is key is

active only if you select external trigger as trigger source.

<b>Key Path</b>	Source, Modulation Setup, ARB, Trigger Source
<b>Remote Command</b>	:SOURce:RADio:ARB:TRIGger[:SOURce]:EXTErnal:DELay <time> :SOURce:RADio:ARB:TRIGger[:SOURce]:EXTErnal:DELay? SOURce:RADio:ARB:TRIGger[:SOURce]:EXTErnal:DELay:STATe OFF   ON   0   1 :SOURce:RADio:ARB:TRIGger[:SOURce]:EXTErnal:DELay:STATe?
<b>Example</b>	:SOUR:RAD:ARB:TRIG:EXT:DEL 100ns :SOUR:RAD:ARB:TRIG:EXT:DEL? :SOUR:RAD:ARB:TRIG:EXT:DEL:STAT ON :SOUR:RAD:ARB:TRIG:EXT:DEL:STAT?
<b>Notes</b>	External trigger delay time set by users will be rounded to the nearest integer multiple of the resolution.
<b>Dependencies</b>	This setting is unavailable and is grayed out when the Trigger Source is not set to external trigger.
<b>Preset</b>	1 ms OFF
<b>Min</b>	0 s
<b>Max</b>	8.589934588 s (Note: This value comes from $4\text{ns} * (2^{31} - 1) = 8589934588\text{ ns}$ )
<b>Initial S/W Revision</b>	A.14.50

### Trigger Initiate

Used to initiate an immediate trigger event if the trigger source is set to Trigger Key.

<b>Key Path</b>	Source, Modulation Setup, ARB
<b>Notes</b>	No remote command, SCPI front panel only.
<b>Initial S/W Revision</b>	A.05.00

### Waveform Sequences

Allows access to the waveform sequence sub-menus. Pressing this key changes the central view area to display the Waveform Sequence List view.

<b>Key Path</b>	Source, Modulation Setup, ARB
<b>Notes</b>	No remote command, SCPI front panel only.
<b>Initial S/W Revision</b>	A.05.00

### Build New Sequence

Allows access to the sub-menus for creating a new waveform sequence. Pressing this key changes the central view area to display the Waveform Sequence Creation and Editing view.

Key Path	Source, Modulation Setup, ARB, Waveform Sequences
Notes	No remote command, SCPI front panel only.
Initial S/W Revision	A.05.00

### Current Segment

Specifies the selected sequence segment that will be affected by the menu functions.

Key Path	Source, Modulation Setup , ARB, Waveform Sequences, Build New Sequence
Notes	No remote command, SCPI front panel only. This key is grayed out and unavailable if the sequence is currently empty.
Initial S/W Revision	A.05.00

### Insert New Waveform

Allows you access to the sub-menu for inserting a new waveform segment or sequence. Pressing this key also changes the central display to show the Waveform File Selection View.

Key Path	Source, Modulation Setup, ARB, Waveform Sequences, Build New Sequence
Notes	No remote command, SCPI front panel only. Waveform segment name string length upper limit is 128 chars. Please do NOT insert waveform which name string exceeds 128 chars.
Initial S/W Revision	A.05.00

### Insert Waveform

Inserts the currently highlighted waveform to the end of the waveform sequence. Pressing this key also returns you to the menus for creating or editing a sequence, and returns the central view to the sequence creation view.

Key Path	Source, Modulation Setup, ARB, Waveform Sequences, Build New Sequence, Insert New Waveform
Notes	No remote command, SCPI front panel only. Waveform segment name string length upper limit is 128 chars. Please do NOT insert waveform which name string exceeds 128 chars.
Initial S/W Revision	A.05.00

### Segments on Hard Disk

Allows you access to the sub-menus for loading waveform segments from the hard disk into ARB memory. The default directory is: D: varb.

Pressing this key changes the current view to the Waveform Management View.

Key Path	Source, Modulation Setup, ARB, Select Waveform
Initial S/W Revision	A.05.00

### Load Segment To ARB Memory

Allows you to load the selected file into ARB memory. On the front panel you select the file for loading to the ARB memory by highlighting the desired file in the list. Using the SCPI command, you specify the file name on the HDD.

“NVWFM” (none-volatile storage) MSUS (Mass Storage Unit Specifier) is supported in the memory subsystem because the ARB memory cannot be accessed directly. Therefore, files must be downloaded to the instrument hard disk and then loaded into the ARB memory. “NVWFM” MSUS will be mapped to the default directory D: VARB. The SCPI command supports using either “NVWFM” MSUS or specifying a full path. For more information, see Memory Subsystem (Remote Command Only).

If a file of the same name already exists within ARB memory, it is overwritten. If you wish to load two segments of the same name, you must rename one of the segments before loading it into ARB memory. To rename a segment, you can either use Windows File Explorer, or the :MMEMory:COPI command.

NOTE: When a waveform file is loaded to ARB memory, burst timing adjustments are made automatically, based on whether or not a Multiport Adapter is connected to the test set and powered on. If the connection/power status of the Multiport Adapter is changed after a waveform file has been loaded, it needs to be loaded again.

Key Path	Source, Modulation Setup, ARB, Select Waveform, Segments on Hard Disk
Remote Command	:SOURce:RADio:ARB:LOAD <string>
Example	:SOUR:RAD:ARB:LOAD "D: VARB\testwaveform.bin" or :SOUR:RAD:ARB:LOAD "NVWFM:testwaveform.bin"
Notes	<p>Because loading the file involves a delay of unpredictable length, this command should be followed by the query *OPC?, which holds off subsequent commands until the loading operating is complete.</p> <p>&lt;string&gt; – specifies the path name of the file to load from the HDD into ARB memory. It could be a &lt;full path + filename&gt;, or &lt;"NVWFM" MSUS + colon + filename&gt;.</p> <p>When in Sequence Analyzer mode, and Include Source is Yes, an attempt to load a file to ARB memory will be rejected with an error.</p> <p>When Include Source is No and if there is insufficient free ARB memory to load the selected waveform, an error is generated. .</p> <p>If you specify a file over SCPI, but the file is not at the specified location, an error is generated.</p> <p>If you try to load a waveform file but the file contains less than 500 IQ samples, an error is generated.</p> <p>If you try to load a Signal Studio waveform "*.wfm" which contains invalid waveform header, an error is generated.</p>



If the ARB is ON when you load a file to ARB memory or delete a file from ARB memory, the playing waveform segment may not keep phase continuity during the ARB memory operation. The waveform will be replayed after the ARB operation is finished.

ARB can be loaded into ARB memory even if required licenses do not present on the instrument. In this case, a GUI only warning message -800, "Operation complete; Loaded <filename> successfully, but no license <required licenses> installed". User can install required licenses according to <required licenses> string to license it, or multi-pack license it.

Initial S/W Revision	A.05.00
----------------------	---------

### Load All To ARB Memory

Allows you to load all the segment files within the currently selected directory into ARB memory. If a file of the same name already exists within ARB memory, it is overwritten. If you wish to load two segments of the same name, you must rename one of the segments before loading it into ARB memory. To rename a segment, you can either use Windows File Explorer, or the :MEMORY:COPY command.

NOTE: When a waveform file is loaded to ARB memory, burst timing adjustments are made automatically, based on whether or not a Multiport Adapter is connected to the test set and powered on. If the connection/power status of the Multiport Adapter is changed after a waveform file has been loaded, it needs to be loaded again.

<b>Key Path</b>	Source, Modulation Setup, ARB, Select Waveform, Segments on Hard Disk
<b>Remote Command</b>	:SOURce:RADio:ARB:LOAD:ALL <string>
<b>Example</b>	:SOUR:RAD:ARB:LOAD:ALL "D: varb"
<b>Notes</b>	<p>&lt;string&gt; - specifies the directory on the HDD to load the files into ARB memory from.</p> <p>When in Sequence Analyzer mode, and Include Source is Yes, an attempt to load all files from a directory to ARB memory is rejected with an error.</p> <p>When Include Source is No and there is insufficient free ARB memory to load all the waveforms, when the ARB memory is full, the copy ceases, and an error is generated.</p> <p>If you specify a directory over SCPI, but the directory does not exist, an error is generated.</p> <p>If the ARB is ON, a user then loads or deletes file to ARB memory, the playing waveform segment may not keep phase continuity during the ARB memory operation. The waveform will be replayed after the ARB operation is finished.</p>
Initial S/W Revision	A.05.00

### Change Directory...

Allows you to change the currently selected directory on the hard disk. Pressing this key opens a standard windows change directory dialog allowing you to select the new directory of interest.

The current directory is used for manually loading waveform segments into ARB memory for playback, and as a search location for waveform segments that are required to be loaded into ARB memory for playback of a waveform sequence or a list sequence.

Key Path	Source, Modulation Setup, ARB, Select Waveform, Segments on Hard Disk
Notes	No remote command, SCPI front panel only.
Initial S/W Revision	A.05.00

#### Default Directory...

Allows you to change the default directory. It is used as a search location for waveform segments that are required to be loaded into ARB memory for playback of a waveform sequence, and as a search location for selecting waveforms using SCPI.

Key Path	Source, Modulation Setup, ARB, Select Waveform, Segments on Hard Disk
<b>Remote Command</b>	:SOURce:RADio:ARB:DEFault:DIRectory <string> :SOURce:RADio:ARB: DEFault:DIRectory?
<b>Example</b>	:SOUR:RAD:ARB:DEF:DIR "D:\ArbFiles" :SOUR:RAD:ARB:DEF:DIR?
State Saved	Persistent, survives a power cycle and a preset but not saved in the instrument state
Initial S/W Revision	A.05.00

#### Segments in ARB Memory

Allows you access to the sub-menus for managing the files within ARB memory.

Key Path	Source, Modulation Setup, ARB, Select Waveform
Initial S/W Revision	A.05.00

#### Delete Segment From ARB Mem

Allows you to remove a segment from ARB playback memory.

Key Path	Source, Modulation Setup, ARB, Select Waveform, Segments in ARB Memory
<b>Remote Command</b>	:SOURce:RADio:ARB:DELete <string>
<b>Example</b>	:SOUR:RAD:ARB:DEL "testwaveform.bin"
Notes	<string> - specifies the waveform to be deleted from the ARB playback memory. When in Sequence Analyzer mode and Include Source is Yes, an attempt to delete a file from ARB memory is rejected with an error. When Include Source is No and you specify a file that does not exist within ARB memory, an error is generated. It is possible to delete files from within the ARB memory when the ARB is ON. However, if you attempt to delete the file that is currently playing an error is generated. It is possible to delete a file from within the ARB memory when the sequencer state is ON and the file is not being used by the List Sequencer. If you attempt to delete a file which is being used by the list

sequencer, an error is generated.

When sequencer state is On, even if ARB state is On, the selected waveform will not be played. In this case, if the selected waveform is not used in List Sequence, it can be deleted and the ARB state is turned Off.

If the ARB is ON and you load a file to ARB memory or delete a file from ARB memory, the playing waveform segment may not keep phase continuity during the ARB memory operation. The waveform will be replayed after the ARB operation is finished.

---

Initial S/W Revision      A.05.00

---

### Delete All From ARB Memory

Allows you to remove all segments from ARB playback memory.

---

<b>Key Path</b>	Source, Modulation Setup, ARB, Select Waveform, Segments in ARB Memory
<b>Remote Command</b>	:SOURce:RADio:ARB:DELeTe:ALL
<b>Example</b>	:SOUR:RAD:ARB:DELeTe:ALL
<b>Notes</b>	<p>When in Sequence Analyzer mode and Include Source is Yes, an attempt to delete all files from ARB memory is rejected with an error.</p> <p>When Include Source is No and you attempt to delete all files from ARB memory when the ARB is currently playing a file, all files except the one playing are deleted and an error is generated.</p> <p>If you attempt to delete all files from ARB memory when there are waveform files used in "<a href="#">List Sequencer</a>" on page 1449 and "<a href="#">Sequencer</a>" on page 1449 state is ON, all files except the files currently being used in list sequencer are deleted, and an error is generated.</p> <p>If the ARB is ON and you load a file to ARB memory or delete a file from ARB memory, the playing waveform segment may not keep phase continuity during the ARB memory operation. The waveform will be replayed after the ARB operation is finished.</p>

---

Initial S/W Revision      A.05.00

---

### Edit Selected Waveform

Allows access to the sub-menus for editing the details of the currently selected waveform segment.

---

<b>Key Path</b>	Source, Modulation Setup, ARB, Waveform Sequences, Build New Sequence
<b>Notes</b>	No remote command, front panel only.
<b>Initial S/W Revision</b>	A.05.00

---

### Repetitions

Allows you to specify the number of times the currently selected waveform is played within the sequence.

---

<b>Key Path</b>	Source, Modulation Setup, ARB, Waveform Sequences, Build New Sequence, Edit Selected Waveform
-----------------	-----------------------------------------------------------------------------------------------

---

---

Notes	No remote command, SCPI front panel only.
Preset	1
Min	1
Max	65535
Initial S/W Revision	A.05.00

---

### Marker 1

Allows you to enable or disable marker 1 for the currently selected waveform. For a waveform sequence, you can enable and disable markers on a per-segment basis, allowing you to output markers from some waveform segments within the sequence, but not for others.

---

Key Path	Source, Modulation Setup, ARB, Waveform Sequences, Build New Sequence, Edit Selected Waveform
Notes	No remote command, front panel only.
Preset	Enabled
Range	Enabled Disabled
Initial S/W Revision	A.05.00

---

### Marker 2

Allows you to enable or disable marker 2 for the currently selected waveform. For a waveform sequence, you can enable and disable markers on a per-segment basis, allowing you to output markers from some waveform segments within the sequence, but not for others.

---

Key Path	Source, Modulation Setup, ARB, Waveform Sequences, Build New Sequence, Edit Selected Waveform
Notes	No remote command, front panel only.
Preset	Enabled
Range	Enabled Disabled
Initial S/W Revision	A.05.00

---

### Marker 3

Allows you to enable or disable marker 3 for the currently selected waveform. For a waveform sequence, you can enable and disable markers on a per-segment basis, allowing you to output markers from some waveform segments within the sequence, but not for others.

---

Key Path	Source, Modulation Setup, ARB, Waveform Sequences, Build New Sequence, Edit Selected Waveform
----------	-----------------------------------------------------------------------------------------------

---

Notes	No remote command, front panel only.
Preset	Enabled
Range	Enabled Disabled
Initial S/W Revision	A.05.00

**Marker 4**

Allows you to enable or disable marker 4 for the currently selected waveform. For a waveform sequence, you can enable and disable markers on a per-segment basis, allowing you to output markers from some waveform segments within the sequence, but not for others.

Key Path	Source, Modulation Setup, ARB, Waveform Sequences, Build New Sequence, Edit Selected Waveform
Notes	No remote command, front panel only.
Preset	Enabled
Range	Enabled Disabled
Initial S/W Revision	A.05.00

**Delete Segment**

Allows you to delete the selected segment from the waveform sequence.

Key Path	Source, Modulation Setup, ARB, Waveform Sequences, Build New Sequence
Notes	No remote command, front panel only.
Initial S/W Revision	A.05.00

**Save Sequence...**

Pressing this key displays the “Save As” dialog. The sequence name is passed to the save as dialog to use as the filename for saving, and the directory the save as dialog will open into is the default waveform directory.

Key Path	Source, Modulation Setup, ARB, Waveform Sequences, Build New Sequence
Initial S/W Revision	A.05.00

**Edit Selected Sequence**

Allows access to the sub-menus for editing the sequence currently selected within the Waveform Sequence List view. Pressing this key changes the central view area to display the Waveform Sequence Creation and Editing view.

---

Key Path	Source, Modulation Setup, ARB, Waveform Sequences
Notes	No remote command, front panel only.
Initial S/W Revision	A.05.00

---

#### Current Directory...

Allows you to change the currently selected directory on the hard disk. Pressing this key opens a standard windows change directory dialog and allows you to select the new directory of interest.

---

Key Path	Source, Modulation Setup, ARB, Waveform Sequences
Notes	No remote command, front panel only.
Initial S/W Revision	A.05.00

---

#### Waveform Utilities

Allows you access to the waveform utilities sub-menus.

---

Key Path	Source, Modulation Setup, ARB
Initial S/W Revision	A.05.00

---

#### Multi-Pack Licenses

Allows you access to the Multi - Pack License sub-menus. Pressing this key also changes the central view area to display the Multi -Pack License Management view.

On modular instrument like E6630A or E6640A, multi-pack license operations are only allowed on the default module, i.e. "Left" module for E6630A or "TRX1" module for E6640A.

---

Key Path	Source, Modulation Setup, ARB, Waveform Utilities
Dependencies	This key is only available if there is at least one Multi-pack license installed on the instrument.
Initial S/W Revision	A.05.00

---

#### Add Waveform

Pressing this key accesses the Add Waveform sub-menu. It also changes the central display area to display the Multi-Pack License Waveform Add view.

---

Key Path	Source, Modulation Setup, ARB, Waveform Utilities, Multi-Pack Licenses
Dependencies	This key is only available if there is at least one slot available within at least one multi-pack license.
Initial S/W Revision	A.05.00

---

### Add Waveform

Allows you to add the currently selected waveform segment to a multi-pack license. The new waveform is added to the next available slot regardless of which slot was selected on the Multi-Pack License Management view.

<b>Key Path</b>	Source, Modulation Setup, ARB, Waveform Utilities, Multi-Pack Licenses, Add Waveform
<b>Remote Command</b>	:SYSTem:LKEY:WAVeform:ADD <string> or :SYSTem:LIcense[:FPACK]:WAVeform:ADD <string>
<b>Example</b>	SYST:LKEY:WAV:ADD "mywaveform.wfm" or SYST:LIC:WAV:ADD "mywaveform.wfm"
<b>Notes</b>	The second SCPI :SYSTem:LIcense[:FPACK]:WAVeform:ADD is provided to be consistent with the style of Keysight signal sources. You can use either one of them. Since adding a waveform segment to a Multi-Pack license causes the license slot to enter the trial period of only 48 hours, pressing this key causes a confirmation dialog to be displayed to ensure you do want to add the waveform segment to the Multi-Pack. If you attempt to license a waveform that is already licensed using another slot an error is generated. .
<b>Dependencies</b>	This key is only available if the currently selected file is a secure waveform requiring a license, and there is at least one slot available within at least one multi-pack license. If the waveform highlighted is a secure waveform, but is already licensed, this key will be unavailable.
<b>Initial S/W Revision</b>	A.05.00

### Segments on Hard Disk

Allows you access to the sub-menus for loading waveform segments from the hard disk into ARB memory. The default directory is: D: varb.

Pressing this key changes the current view to the Waveform Management View.

<b>Key Path</b>	Source, Modulation Setup, ARB, Select Waveform
<b>Initial S/W Revision</b>	A.05.00

### Load Segment To ARB Memory

Allows you to load the selected file into ARB memory. On the front panel you select the file for loading to the ARB memory by highlighting the desired file in the list. Using the SCPI command, you specify the file name on the HDD.

"NVWFM" (none-volatile storage) MSUS (Mass Storage Unit Specifier) is supported in the memory subsystem because the ARB memory cannot be accessed directly. Therefore, files must be downloaded to the instrument hard disk and then loaded into the ARB memory. "NVWFM" MSUS will be mapped to the

default directory D: VARB. The SCPI command supports using either “NVWFM” MSUS or specifying a full path. For more information, see Memory Subsystem (Remote Command Only).

If a file of the same name already exists within ARB memory, it is overwritten. If you wish to load two segments of the same name, you must rename one of the segments before loading it into ARB memory. To rename a segment, you can either use Windows File Explorer, or the :MMEMory:COPI command.

NOTE: When a waveform file is loaded to ARB memory, burst timing adjustments are made automatically, based on whether or not a Multiport Adapter is connected to the test set and powered on. If the connection/power status of the Multiport Adapter is changed after a waveform file has been loaded, it needs to be loaded again.

<b>Key Path</b>	Source, Modulation Setup, ARB, Select Waveform, Segments on Hard Disk
<b>Remote Command</b>	:SOURce:RADio:ARB:LOAD <string>
<b>Example</b>	:SOUR:RAD:ARB:LOAD "D: VARB\testwaveform.bin" or :SOUR:RAD:ARB:LOAD "NVWFM:testwaveform.bin"
<b>Notes</b>	<p>Because loading the file involves a delay of unpredictable length, this command should be followed by the query *OPC?, which holds off subsequent commands until the loading operating is complete.</p> <p>&lt;string&gt; – specifies the path name of the file to load from the HDD into ARB memory. It could be a &lt;full path + filename&gt;, or &lt;“NVWFM” MSUS + colon + filename&gt;.</p> <p>When in Sequence Analyzer mode, and Include Source is Yes, an attempt to load a file to ARB memory will be rejected with an error.</p> <p>When Include Source is No and if there is insufficient free ARB memory to load the selected waveform, an error is generated. .</p> <p>If you specify a file over SCPI, but the file is not at the specified location, an error is generated.</p> <p>If you try to load a waveform file but the file contains less than 500 IQ samples, an error is generated.</p> <p>If you try to load a Signal Studio waveform “*.wfm” which contains invalid waveform header, an error is generated.</p> <p>If the ARB is ON when you load a file to ARB memory or delete a file from ARB memory, the playing waveform segment may not keep phase continuity during the ARB memory operation. The waveform will be replayed after the ARB operation is finished.</p> <p>ARB can be loaded into ARB memory even required licenses do not present on the instrument. In this case, a GUI only warning message –800, “Operation complete; Loaded &lt;filename&gt; successfully, but no license &lt;required licenses&gt; installed”. User can install required licenses according to &lt;required licenses&gt; string to license it, or multi-pack license it.</p>
<b>Initial S/W Revision</b>	A.05.00

### Load All To ARB Memory

Allows you to load all the segment files within the currently selected directory into ARB memory. If a file of the same name already exists within ARB memory, it is overwritten. If you wish to load two segments of the same name, you must rename one of the segments before loading it into ARB memory. To rename a segment, you can either use Windows File Explorer, or the :MEMory:COPI command.

NOTE: When a waveform file is loaded to ARB memory, burst timing adjustments are made automatically, based on whether or not a Multiport Adapter is connected to the test set and powered on. If the



connection/power status of the Multiport Adapter is changed after a waveform file has been loaded, it needs to be loaded again.

Key Path	Source, Modulation Setup, ARB, Select Waveform, Segments on Hard Disk
Remote Command	:SOURce:RADio:ARB:LOAD:ALL <string>
Example	:SOUR:RAD:ARB:LOAD:ALL "D: varb"
Notes	<p>&lt;string&gt; - specifies the directory on the HDD to load the files into ARB memory from.</p> <p>When in Sequence Analyzer mode, and Include Source is Yes, an attempt to load all files from a directory to ARB memory is rejected with an error.</p> <p>When Include Source is No and there is insufficient free ARB memory to load all the waveforms, when the ARB memory is full, the copy ceases, and an error is generated.</p> <p>If you specify a directory over SCPI, but the directory does not exist, an error is generated.</p> <p>If the ARB is ON, a user then loads or deletes file to ARB memory, the playing waveform segment may not keep phase continuity during the ARB memory operation. The waveform will be replayed after the ARB operation is finished.</p>
Initial S/W Revision	A.05.00

#### Change Directory...

Allows you to change the currently selected directory on the hard disk. Pressing this key opens a standard windows change directory dialog allowing you to select the new directory of interest.

The current directory is used for manually loading waveform segments into ARB memory for playback, and as a search location for waveform segments that are required to be loaded into ARB memory for playback of a waveform sequence or a list sequence.

Key Path	Source, Modulation Setup, ARB, Select Waveform, Segments on Hard Disk
Notes	No remote command, SCPIfront panel only.
Initial S/W Revision	A.05.00

#### Default Directory...

Allows you to change the default directory. It is used as a search location for waveform segments that are required to be loaded into ARB memory for playback of a waveform sequence, and as a search location for selecting waveforms using SCPI.

Key Path	Source, Modulation Setup, ARB, Select Waveform, Segments on Hard Disk
Remote Command	:SOURce:RADio:ARB:DEFault:DIRectory <string> :SOURce:RADio:ARB: DEFault:DIRectory?
Example	:SOUR:RAD:ARB:DEF:DIR "D:\ArbFiles" :SOUR:RAD:ARB:DEF:DIR?
State Saved	Persistent, survives a power cycle and a preset but not saved in the instrument state
Initial S/W Revision	A.05.00

### Replace Waveform

Pressing this key accesses the Replace Waveform submenu. It also changes the central display area to display the Multi-Pack License Waveform Add view.

Key Path	Source, Modulation Setup, ARB, Waveform Utilities, Multi-Pack Licenses
Dependencies	This key is only available if the currently selected slot is in the trial state.
Initial S/W Revision	A.05.00

### Replace Waveform

Allows you to replace the waveform in the currently selected slot with the waveform currently selected in the Multi-Pack License Waveform Add view.

Key Path	Source, Modulation Setup, ARB, Waveform Utilities, Multi-Pack Licenses, Replace Waveform
Remote Command	:SYSTem:LKEY:WAVeform:REPLace <int>, <string> or :SYSTem:LICense[:FPACK]:WAVeform:REPLace <int>, <string>
Example	SYST:LKEY:WAV:REPL 1, "myotherwaveform.wfm" or :SYST:LIC:WAV:REPL 1, "myotherwaveform.wfm"
Notes	The second SCPI :SYSTem:LICense[:FPACK]:WAVeform:REPLace is provided to be consistent with the style of Keysight signal sources. You can use either one of them. If you attempt to license a waveform that is already licensed using another slot an error is generated. Waveform slot number <int> is positive. If you attempt to input a slot number less than or equals 0, an error is generated.
Initial S/W Revision	A.05.00

### Clear Waveform from Slot

Allows you to clear the waveform from the selected slot.

Key Path	Source, Modulation Setup, ARB, Waveform Utilities, Multi-Pack Licenses
Remote Command	:SYSTem:LKEY:WAVeform:CLEar <int> or :SYSTem:LICense[:FPACK]:WAVeform:CLEar <int>
Example	SYST:LKEY:WAV:CLE 1 or :SYST:LIC:WAV:CLE 1
Notes	The second SCPI :SYSTem:LICense[:FPACK]:WAVeform:CLEar is provided to be consistent with the style of Keysight signal sources. You can use either one of them. Waveform slot number <int> is positive. If you attempt to input a slot number less than or equals 0, an error is generated.

---

error is generated.

---

Dependencies	This key is only available if the currently selected slot is in the trial state.
Initial S/W Revision	A.05.00

---

### Lock Waveform in Slot

If the selected slot is in the trial state or the lock required state, the waveform that occupies the slot is locked and permanently licensed.

---

Key Path	Source, Modulation Setup, ARB, Waveform Utilities, Multi-Pack Licenses
<b>Remote Command</b>	:SYSTem:LKEY:WAVeform:LOCK <int> or :SYSTem:LICense[:FPACK]:WAVeform:LOCK <int>
<b>Example</b>	SYST:LKEY:WAV:LOCK 1 or SYST:LIC:WAV:LOCK 1
Notes	The second SCPI :SYSTem:LICense[:FPACK]:WAVeform:LOCK is provided to be consistent with the style of Keysight signal sources. You can use either one of them. Waveform slot number <int> is positive. If you attempt to input a slot number less than or equals 0, an error is generated.
Dependencies	This key is only available if the currently selected slot is in the trial state or the lock required state.
Initial S/W Revision	A.05.00

---

### Marker Utilities

Allows access to the marker utilities sub-menus.

---

Key Path	Source, Modulation Setup, ARB
Initial S/W Revision	A.05.00

---

### Marker Polarity

Allows access to the marker polarity sub-menu, which allows you to specify the polarity for the four markers. For a positive polarity, the marker signal is high during the marker points. For a negative marker polarity, the marker signal is high during the period of no marker points.

---

Key Path	Source, Modulation Setup, ARB, Marker Utilities
Initial S/W Revision	A.05.00

---

### Mkr 1 Polarity

Allows you to set the polarity of marker 1.

<b>Key Path</b>	Source, Modulation Setup, ARB, Marker Utilities, Marker Polarity
<b>Remote Command</b>	:SOURce:RADio:ARB:MPOLarity:MARKer1 POSitive NEGative :SOURce:RADio:ARB:MPOLarity:MARKer1?
<b>Example</b>	:SOUR:RAD:ARB:MPOL:MARK1 NEG
<b>Dependencies</b>	When a new waveform is selected for playback the settings contained within the associated waveform header file are applied to the ARB. The marker polarity is one of the values stored within the header file. If the newly selected waveform file has an associated header file, the marker polarity is updated with the value from the header file. The marker polarity will remain unchanged if the newly selected waveform does not have an associated header file.
<b>Preset</b>	Pos
<b>Range</b>	Neg   Pos
<b>Initial S/W Revision</b>	A.05.00

### Mkr 2 Polarity

Allows you to set the polarity of marker 2.

<b>Key Path</b>	Source, Modulation Setup, ARB, Marker Utilities, Marker Polarity
<b>Remote Command</b>	:SOURce:RADio:ARB:MPOLarity:MARKer2 POSitive NEGative :SOURce:RADio:ARB:MPOLarity:MARKer2?
<b>Example</b>	:SOUR:RAD:ARB:MPOL:MARK2 NEG
<b>Dependencies</b>	When a new waveform is selected for playback the settings contained within the associated waveform header file are applied to the ARB. The marker polarity is one of the values stored within the header file. If the newly selected waveform file has an associated header file, the marker polarity is updated with the value from the header file. The marker polarity will remain unchanged if the newly selected waveform does not have an associated header file.
<b>Preset</b>	Pos
<b>Range</b>	Neg   Pos
<b>Initial S/W Revision</b>	A.05.00

### Mkr 3 Polarity

Allows you to set the polarity of marker 3.

<b>Key Path</b>	Source, Modulation Setup, ARB, Marker Utilities, Marker Polarity
<b>Remote Command</b>	:SOURce:RADio:ARB:MPOLarity:MARKer3 POSitive NEGative :SOURce:RADio:ARB:MPOLarity:MARKer3?
<b>Example</b>	:SOUR:RAD:ARB:MPOL:MARK3 NEG
<b>Dependencies</b>	When a new waveform is selected for playback the settings contained within the associated

	waveform header file are applied to the ARB. The marker polarity is one of the values stored within the header file. If the newly selected waveform file has an associated header file, the marker polarity is updated with the value from the header file. The marker polarity will remain unchanged if the newly selected waveform does not have an associated header file.
Preset	Pos
Range	Neg   Pos
Initial S/W Revision	A.05.00

### Mkr 4 Polarity

Allows you to set the polarity of marker 4.

Key Path	Source, Modulation Setup, ARB, Marker Utilities, Marker Polarity
Remote Command	:SOURce:RADio:ARB:MPOLarity:MARKer4 POSitive NEGative :SOURce:RADio:ARB:MPOLarity:MARKer4?
Example	:SOUR:RAD:ARB:MPOL:MARK4 NEG
Dependencies	When a new waveform is selected for playback the settings contained within the associated waveform header file are applied to the ARB. The marker polarity is one of the values stored within the header file. If the newly selected waveform file has an associated header file, the marker polarity is updated with the value from the header file. The marker polarity will remain unchanged if the newly selected waveform does not have an associated header file.
Preset	Pos
Range	Neg   Pos
Initial S/W Revision	A.05.00

### Marker Routing

Allows access to the marker routing sub-menus, which allow you to specify where the marker events are routed. It should be noted that the markers can also be routed to Trigger 1 Out and Trigger 2 Out, however this must be set up using the menus accessed by pressing the “Trigger” hard key.

Key Path	Source, Modulation Setup, ARB, Marker Utilities
Initial S/W Revision	A.05.00

### Pulse/RF Blank

Allows you to select which marker is used for the pulse/RF blanking function. The pulse/RF blanking function blanks the RF when the marker signal goes low. The marker polarity determines when the marker signal is high. For a positive polarity, this is during the marker points. For a negative polarity, this is when there are no marker points.

Marker points should be set before using this function. Enabling this function without setting maker points may create a continuous low or high signal, dependant on the marker polarity. This causes either no RF output, or a continuous RF output.

<b>Key Path</b>	Source, Modulation Setup, ARB, Marker Utilities, Marker Routing
<b>Remote Command</b>	:SOURce:RADio:ARB:MDEStination:PULSe NONE   M1   M2   M3   M4 :SOURce:RADio:ARB:MDEStination:PULSe?
<b>Example</b>	:SOUR:RAD:ARB:MDES:PULS NONE
<b>Dependencies</b>	When a new waveform is selected for playback the settings contained within the associated waveform header file are applied to the ARB. The pulse/RF blanking setting is one of the values stored within the header file. If the newly selected waveform file has an associated header file, the pulse/RF blanking setting is updated with the value from the header file. The pulse/RF blanking setting will remain unchanged if the newly selected waveform does not have an associated header file.
<b>Range</b>	None   M1   M2   M3   M4
<b>Initial S/W Revision</b>	A.05.00

#### None

Sets no marker to be used for the pulse/RF blanking function, essentially turning the RF blanking function off.

<b>Key Path</b>	Source, Modulation Setup, ARB, Marker Utilities, Marker Routing, Pulse/RF Blank
<b>Example</b>	:SOUR:RAD:ARB:MDES:PULS NONE
<b>Initial S/W Revision</b>	A.05.00

#### Marker 1

Sets marker 1 to be used for the pulse/RF blanking function.

<b>Key Path</b>	Source, Modulation Setup, ARB, Marker Utilities, Marker Routing, Pulse/RF Blank
<b>Example</b>	:SOUR:RAD:ARB:MDES:PULS M1
<b>Initial S/W Revision</b>	A.05.00

#### Marker 2

Sets marker 2 to be used for the pulse/RF blanking function.

<b>Key Path</b>	Source, Modulation Setup, ARB, Marker Utilities, Marker Routing, Pulse/RF Blank
<b>Example</b>	:SOUR:RAD:ARB:MDES:PULS M2
<b>Initial S/W Revision</b>	A.05.00

### Marker 3

Sets marker 3 to be used for the pulse/RF blanking function.

Key Path	Source, Modulation Setup, ARB, Marker Utilities, Marker Routing, Pulse/RF Blank
<b>Example</b>	:SOUR:RAD:ARB:MDES:PULS M3
Initial S/W Revision	A.05.00

### Marker 4

Sets marker 4 to be used for the pulse/RF blanking function.

Key Path	Source, Modulation Setup, ARB, Marker Utilities, Marker Routing, Pulse/RF Blank
<b>Example</b>	:SOUR:RAD:ARB:MDES:PULS M4
Initial S/W Revision	A.05.00

### ALC Hold

Allows you to specify which marker is routed for use within the ALC hold function. The ALC hold marker function holds the ALC circuitry at the average value of the sample points set by the marker.

The ALC hold function operates during the low periods of the marker signal. The marker polarity determines when the marker signal is high. For positive polarity, this is during the marker points. For a negative polarity, this is when there are no marker points.

Key Path	Source, Modulation Setup, ARB, Marker Utilities, Marker Routing
<b>Remote Command</b>	:SOURce:RADio:ARB:MDEStination:ALCHold NONE M1 M2 M3 M4 :SOURce:RADio:ARB:MDEStination:ALCHold?
<b>Example</b>	:SOUR:RAD:ARB:MDES:ALCH NONE
Dependencies	When a new waveform is selected for playback the settings contained within the associated waveform header file are applied to the ARB. The ALC hold setting is one of the values stored within the header file. If the newly selected waveform file has an associated header file, the ALC hold setting is updated with the value from the header file. The ALC hold setting will remain unchanged if the newly selected waveform does not have an associated header file.
Range	None   M1   M2   M3   M4
Initial S/W Revision	A.05.00

### None

Sets no marker to be used for the ALC hold function, essentially turning the ALC hold function off.

Key Path	Source, Modulation Setup, ARB, Marker Utilities, Marker Routing, ALC Hold
<b>Example</b>	:SOUR:RAD:ARB:MDES:PULS NONE
Initial S/W Revision	A.05.00

### Marker 1

Sets marker 1 to be used for the ALC hold function.

Key Path	Source, Modulation Setup, ARB, Marker Utilities, Marker Routing, ALC Hold
<b>Example</b>	:SOUR:RAD:ARB:MDES:PULS M1
Initial S/W Revision	A.05.00

### Marker 2

Sets marker 2 to be used for the ALC hold function.

Key Path	Source, Modulation Setup, ARB, Marker Utilities, Marker Routing, ALC Hold
<b>Example</b>	:SOUR:RAD:ARB:MDES:PULS M2
Initial S/W Revision	A.05.00

### Marker 3

Sets marker 3 to be used for the ALC hold function.

Key Path	Source, Modulation Setup, ARB, Marker Utilities, Marker Routing, ALC Hold
<b>Example</b>	:SOUR:RAD:ARB:MDES:PULS M3
Initial S/W Revision	A.05.00

### Marker 4

Sets marker 4 to be used for the ALC hold function.

Key Path	Source, Modulation Setup, ARB, Marker Utilities, Marker Routing, ALC Hold
<b>Example</b>	:SOUR:RAD:ARB:MDES:PULS M4
Initial S/W Revision	A.05.00

### Header Utilities

Allows access to the header utilities sub-menu. Pressing this key also causes the central display area to change to display the File Header Information view.

Key Path	Source, Modulation Setup, ARB
Dependencies	This key is only available if there is currently a waveform selected for playback. If no waveform is selected, the key is grayed out.
Initial S/W Revision	A.05.00



### Clear Header

Allows you to clear the header information from the file header associated with the currently selected waveform.

<b>Key Path</b>	Source, Modulation Setup, ARB, Header Utilities
<b>Remote Command</b>	:SOURce:RADio:ARB:HEADer:CLEar
<b>Example</b>	:SOUR:RAD:ARB:HEAD:CLE
<b>Notes</b>	Attempting to clear the header details via SCPI when no waveform was selected for playback will generate an error.
<b>Initial S/W Revision</b>	A.05.00

### Save Setup To Header

Allows you to save new file header information details to the file.

<b>Key Path</b>	Source, Modulation Setup, ARB, Header Utilities
<b>Remote Command</b>	:SOURce:RADio:ARB:HEADer:SAVE
<b>Example</b>	:SOUR:RAD:ARB:HEAD:SAVE
<b>Notes</b>	Attempting to save the header details via SCPI when no waveform was selected for playback will generate an error.
<b>Initial S/W Revision</b>	A.05.00

### AM

Allows access to the menu for configuring the Amplitude Modulation.

<b>Key Path</b>	Source, Modulation Setup
<b>Initial S/W Revision</b>	A.05.00

### AM

Enables or disables the amplitude modulation.

Turning AM on when another modulation format is already on results in the previous modulation format being turned off and the generation of an error.

<b>Key Path</b>	Source, Modulation Setup, AM
<b>Remote Command</b>	:SOURce:AM:STATe :SOURce:AM:STATe?
<b>Example</b>	:SOUR:AM:STAT OFF

Preset	Off
Range	On   Off
Initial S/W Revision	A.05.00

### AM Depth

Allows you to set the amplitude modulation depth in percent.

Key Path	Source, Modulation Setup, AM
<b>Remote Command</b>	:SOURce:AM[:DEPTh] [:LINear] :SOURce:AM[:DEPTh] [:LINear]?
<b>Example</b>	:SOUR:AM 0.1
Preset	0.1 %
Min	0.1 %
Max	95.0 %
Initial S/W Revision	A.05.00

### AM Rate

Allows you to set the internal amplitude modulation rate.

Key Path	Source, Modulation Setup, AM
<b>Remote Command</b>	:SOURce:AM:INTernal:FREQuency :SOURce:AM:INTernal:FREQuency?
<b>Example</b>	:SOUR:AM:INT:FREQ 40.0 Hz
Preset	400.0 Hz
Min	10 Hz
Max	40 kHz
Initial S/W Revision	A.05.00

### FM

Allows access to the menu for configuring the frequency modulation.

Key Path	Source, Modulation Setup
Initial S/W Revision	A.05.00

## FM

Enables or disables the frequency modulation.

Turning FM on when another modulation format is already on results in the previous modulation format being turned off and the generation of an error.

Key Path	Source, Modulation Setup, FM
<b>Remote Command</b>	:SOURce:FM:STATe :SOURce:FM:STATe?
<b>Example</b>	:SOUR:FM:STAT OFF
Preset	Off
Range	On   Off
Initial S/W Revision	A.05.00

## FM Deviation

Allows you to set the frequency modulation deviation.

Key Path	Source, Modulation Setup, FM
<b>Remote Command</b>	:SOURce:FM[:DEVIation] :SOURce:FM[:DEVIation]?
<b>Example</b>	:SOUR:FM 1.00 kHz
Preset	1.00 Hz
Min	1.00 Hz
Max	100.00 kHz
Initial S/W Revision	A.05.00

## FM Rate

Allows you to set the internal frequency modulation rate.

Key Path	Source, Modulation Setup, FM
<b>Remote Command</b>	:SOURce:FM:INTernal:FREQuency :SOURce:FM:INTernal:FREQuency?
<b>Example</b>	:SOUR:FM:INT:FREQ 40.0 Hz
Preset	400.0 Hz
Min	10 Hz
Max	40 kHz
Initial S/W Revision	A.05.00

## PM

Allows access to the menu for configuring the phase modulation.

Key Path	Source, Modulation Setup
Initial S/W Revision	A.05.00

## PM

Enables or disables the phase modulation.

Turning PM on when another modulation format is already on results in the previous modulation format being turned off and the generation of an error.

Key Path	Source, Modulation Setup, PM
<b>Remote Command</b>	:SOURce:PM:STATe :SOURce:PM:STATe?
<b>Example</b>	:SOUR:PM:STAT OFF
Preset	Off
Range	On   Off
Initial S/W Revision	A.05.00

## PM Deviation

Allows you to set the phase modulation deviation.

Key Path	Source, Modulation Setup, PM
<b>Remote Command</b>	:SOURce:PM[:DEViation] :SOURce:PM[:DEViation]?
<b>Example</b>	:SOUR:PM 1.00 rad
Preset	0.1 rad
Min	0.1 rad
Max	20.0 rad
Initial S/W Revision	A.05.00

## PM Rate

Allows you to set the internal phase modulation rate.

Key Path	Source, Modulation Setup, PM
<b>Remote Command</b>	:SOURce:PM:INTernal:FREQuency :SOURce:PM:INTernal:FREQuency?

<b>Example</b>	:SOUR:PM:INT:FREQ 40.0 Hz
Preset	400.0 Hz
Min	10 Hz
Max	40 kHz
Initial S/W Revision	A.05.00

## List Sequencer

Allows you access to the sub-menus for configuring the list sequencer.

List sequences allows you to enter frequencies and amplitudes at unequal intervals in nonlinear ascending, descending or random order. Each step within the list can also include its own waveform file for playback, step duration, trigger event and trigger output.

The complexities involved in configuring the list sequencer do not lend itself to manual configuration; hence the manual configuration for this feature is limited. For easier configuration of the list sequencer, it is recommended that you use either SCPI or load a tab delimited file containing the setup parameters in a tabular form. The details of the SCPI for configuring the list sequencer can be found in Step Configuration (Remote Command Only).

Once the List Sequencer has been configured using the front panel, SCPI, or loading in a tab delimited file, the sequence must be initiated using the front panel Initiate Sequence key or the corresponding SCPI command.

<b>Key Path</b>	<b>Source</b>
Initial S/W Revision	A.05.00

## Sequencer

Allows you to set the state of the list sequencer. When the list sequencer is on, the source is outputting the sequence defined by the sequencer. When the list sequencer is off, the source outputs a single waveform segment or sequence (independent mode) at a single frequency and amplitude.

<b>Key Path</b>	<b>Source, List Sequencer</b>
<b>Remote Command</b>	:SOURce:LIST[:STATe] ON OFF 1 0 :SOURce:LIST[:STATe]?
<b>Example</b>	:SOUR:LIST OFF
<b>Notes</b>	When the sequencer is set to ON, the list sequencer controls the output of the source.
<b>Couplings</b>	When in Sequence Analyzer mode and the list sequencer state is Off, Include Source is forced to No, and the Include Source key is grayed out. When in Sequence Analyzer mode and the list sequencer state is On, Include Source is available to set. And, an ARB memory related operation, like load or delete will be rejected.

Preset	Off
Range	On   Off
Initial S/W Revision	A.05.00

## Initiate Sequence

Pressing this key arms the sequence for single execution. Once the sequence is armed the source begins the sequence as soon as the trigger is received. If the trigger is set to Free Run, the sequence starts immediately.

Key Path	Source, List Sequencer
Remote Command	:SOURce:LIST:TRIGger [:IMMediate]
Example	:SOUR:LIST:TRIG
Notes	<p>When in Sequence Analyzer mode and Include Source is Yes, the Initiate list sequencer operation is rejected, and the key is grayed out, since source list sequence request is sent to physics via Parallel batch by sequence analyzer.</p> <p>If the file needed by the sequencer is not already in ARB memory, the sequence cannot be initiated and an error will be generated.</p> <p>There is a blocking SCPI query which can be used to query if source list sequence being initiated successfully or not. (see Query List Sequence Initiation Armed Status (Remote Command Only) Query Source List Sequence Armed Status)</p>
Dependencies	Under the Sequence Analyzer Mode, if Meas Setup->Include Source is set to YES, Source->List Sequencer->Initiate Sequence is disabled.
Initial S/W Revision	A.05.00

## List Sequencer Setup

Allows you access to the list sequencer setup menus.

Key Path	Source, List Sequencer
----------	------------------------

### Number of Steps

Allows you to specify the number of steps within the list sequence.

Key Path	Source, List Sequencer, List Sequencer Setup
Remote Command	:SOURce:LIST:NUMBer:STEPs <integer> :SOURce:LIST:NUMBer:STEPs?
Example	:SOUR:LIST:NUMB:STEP 1
Notes	Increasing the number of steps creates additional steps at the end of the list, with all the settings

	within the steps set to their default values. Decreasing the number of steps removes steps from the end of the list. The settings within the removed steps are not reset. This means that increasing the number of steps again would allow you to retrieve these steps.
Dependencies	The Step Count parameter is increased or decreased when you insert or delete a point from within the GUI interface to the sequencer.
Preset	1
Min	1
Max	1000
Initial S/W Revision	A.05.00

### Current Step

Allows you to select the step number you wish to view or edit.

Key Path	Source, List Sequencer, List Sequencer Setup
Notes	No remote command, front panel only.
Preset	1
Min	1
Max	Step Count
Initial S/W Revision	A.05.00

### Insert Step Before

Allows you to insert a new step, containing default values, before the currently selected step. Inserting a step will automatically increase the Step Count parameter by 1. If sequence already reaches upper limit of 1000 steps, then insert more step will be rejected and popup error -221, "Setting Conflict; Cannot insert more steps, maximum number of steps reached"

Key Path	Source, List Sequencer, List Sequencer Setup
Notes	No remote command, front panel only. If the list already contains the maximum limit of 1000 steps, no operation will be made after pressing this key.
Initial S/W Revision	A.05.00

### Delete Step

Allows you to delete the current step. Deleting a step will automatically decrease the Step Count parameter by 1. If sequence only has one step left, delete step will be rejected and popup error -221, "Setting conflict; Cannot delete current step, minimum number of steps reached"

Key Path	Source, List Sequencer, List Sequencer Setup
Notes	No remote command, Front Panel key only. If the list already contains the minimum limit of 1 step, no operation will be made after pressing this key
Initial S/W Revision	A.05.00

### Clear List

Allows you to clear the list. Clearing the list sets the number of steps to the default value of 1 and sets the parameters for the only step to their default values.

Key Path	Source, List Sequencer, List Sequencer Setup
Initial S/W Revision	A.05.00

### Step Trigger

Allows access to the sub-menu for selecting the trigger input for the current step.

Key Path	Source, List Sequencer, List Sequencer Setup
Remote Command	:SOURCE:LIST:STEP[1] 2 3...1000:SETup:INPut:TRIGger IMMEDIATE   INTERNAL   EXTERNAL2   KEY   BUS   EXTERNAL4  :SOURCE:LIST:STEP[1] 2 3...1000:SETup:INPut:TRIGger?
Example	:SOUR:LIST:STEP2:SET:INP:TRIG BUS :SOUR:LIST:STEP2:SET:INP:TRIG?
Notes	SCPI is supported after A.09.40
Preset	Free Run
Range	Free Run   Internal   Manual (Trigger Key)   Bus   External 2   EXTERNAL4
Initial S/W Revision	A.05.00

### Free Run

Sets the trigger input for the current step to Free Run.

Key Path	Source, List Sequencer, List Sequencer Setup, Step Trigger
Example	:SOUR:LIST:STEP2:SET:INP:TRIG IMM
Notes	SCPI is supported after A.09.40
Initial S/W Revision	A.05.00

### Internal

Sets the trigger input for the current step to Internal.



Key Path	Source, List Sequencer, List Sequencer Setup, Step Trigger
<b>Example</b>	:SOUR:LIST:STEP2:SET:INP:TRIG INT
Notes	SCPI is supported after A.09.40
Initial S/W Revision	A.05.00

### Manual (Trigger Key)

Sets the trigger input for the current step to Manual (Trigger Key). Any step in the sequence set to Manual will cause the sequence execution to stop until the manual trigger key is pressed. Sending the Bus Trigger SCPI command will have no effect. At any point in the sequence where the list sequencer is paused waiting for a software trigger, a pop up dialog is displayed until the trigger event occurs.

Key Path	Source, List Sequencer, List Sequencer Setup, Step Trigger
<b>Example</b>	:SOUR:LIST:STEP2:SET:INP:TRIG KEY
Notes	SCPI is supported after A.09.40
Initial S/W Revision	A.05.00

### Bus

Sets the trigger input for the current step to Bus. Any step in the sequence set to Bus will cause the sequence execution to stop until the Bus Trigger SCPI command is sent. Pressing the manual trigger key has no effect. At any point in the sequence where the list sequencer is paused waiting for a software trigger, a pop up dialog is displayed until the trigger event occurs.

Key Path	Source, List Sequencer, List Sequencer Setup, Step Trigger
<b>Example</b>	:SOUR:LIST:STEP2:SET:INP:TRIG BUS
Notes	SCPI is supported after A.09.40
Initial S/W Revision	A.05.00

### External 2

Sets the trigger input for the current step to External 2.

Key Path	Source, List Sequencer, List Sequencer Setup, Step Trigger
<b>Example</b>	:SOUR:LIST:STEP2:SET:INP:TRIG EXT2
Notes	SCPI is supported after A.09.40
Notes	Note: When on E6640A, trigger 2 is a bi-directional trigger port. So when trigger 2 has been configured as OUTPUT type, choosing External 2 as the input trigger for the current step will generate error.
Initial S/W Revision	A.05.00

## Transition Time

Allows you to specify the transition time for the current step.

The transition time is the amount of time allowed for the source to settle at the current frequency or amplitude value.

Transition Time should not be taken as additional time before or inside the Step Duration. You can set a value for the settling time to allow the source output frequency or amplitude to become stable. Make sure that during this period of time, you do not use the source output signal.

The following table lists recommended values for appropriate settling times to allow for changes within the source.

Value Changed	Recommended Transition Time
Frequency	500 $\mu$ s
Amplitude	100 $\mu$ s to within 0.1 dB 20 $\mu$ s to within 1.0 dB

If the Transition Time value is shorter than the time necessary for the hardware to settle and a List Sequence is initiated, a **warning** is generated.

If the Transition Time value is longer than the Step Duration, an error is generated when initiating a source list sequence. For source list sequence, transition time is included in the step duration length. If the Transition Time value is longer than the Step Duration Time, the real step duration length is extended to equal the transition time and cause a timing shift.

Key Path	Source, List Sequencer, List Sequencer Setup
Remote Command	:SOURce:LIST:STEP[1] 2 3...1000:SETup:TRANSition:TIME <time> :SOURce:LIST:STEP[1] 2 3...1000:SETup:TRANSition:TIME?
Example	:SOUR:LIST:STEP2:SET:TRAN:TIME 1ms :SOUR:LIST:STEP2:SET:TRAN:TIME?
Notes	SCPI is supported after A.09.40
Preset	1.0 ms
Min	0.0 ms
Max	4.0 ks
Initial S/W Revision	A.05.00

## Radio Setup

Allows you access to the sub-menus for setting up the radio standard, band, and radio band link direction for the current step.

Key Path	Source, List Sequencer, List Sequencer Setup
Notes	No remote command, front panel only.

---

Initial S/W Revision	A.05.00
----------------------	---------

---

### Radio Standard

Allows access to the sub-menus for selecting the radio standard and the associated radio band for use in the current step.

<b>Key Path</b>	Source, List Sequencer, List Sequencer Setup, Radio Setup
<b>Remote Command</b>	:SOURce:LIST:STEP[1] 2 3...1000:SETup:RADio:BAND NONE   PGSM   EGSM   RGSM   DCS1800   PCS1900   TGSM810   GSM450   GSM480   GSM700   GSM850   BANDI   BANDII   BANDIII   BANDIV   BANDV   BANDVI   BANDVII   BANDVIII   BANDIX   BANDX   BANDXI   BANDXII   BANDXIII   BANDXIV   BANDXIX   USCELL   USPCS   JAPAN   KOREAN   NMT   IMT2K   UPPER   SECOND   PAMR400   PAMR800   IMTEXT   PCS1DOT9G   AWS   US2DOT5G   PUBLIC   LOWER   NONE   BAND1   BAND2   BAND3   BAND4   BAND5   BAND6   BAND7   BAND8   BAND10   BAND11   BAND12   BAND13   BAND14   BAND17   BAND18   BAND19   BAND20   BAND21   BAND24   BAND25   BAND26   BAND27   BAND28   BAND29   BAND30   BAND31   BAND33   BAND34   BAND35   BAND36   BAND37   BAND38   BAND39   BAND40   BAND41   BAND42   BAND43   BAND44   BANDA   BANDB   BANDC   BANDD   BANDE   BANDF  :SOURce:LIST:STEP[1] 2 3...1000:SETup: RADio:BAND?
<b>Example</b>	:SOUR:LIST:STEP2:SET:RAD:BAND PGSM :SOUR:LIST:STEP2:SET:RAD:BAND?
<b>Notes</b>	SCPI is supported after A.09.40
Initial S/W Revision	A.05.00

### None

Selects no radio standard for use on the current step.

<b>Key Path</b>	Source, List Sequencer, List Sequencer Setup, Radio Setup, Radio Standard
<b>Example</b>	:SOUR:LIST:STEP2:SET:RAD:BAND NONE
<b>Notes</b>	SCPI is supported after A.09.40
Initial S/W Revision	A.05.00

### GSM/EDGE

Pressing this key once selects GSM/EDGE as the radio standard and the current GSM/EDGE band as the active channel band. Pressing this key again allows access to the sub-menus for selecting a different GSM/EDGE band.

<b>Key Path</b>	Source, List Sequencer, List Sequencer Setup, Radio Setup, Radio Standard
Initial S/W Revision	A.05.00

### P-GSM

Selects P-GSM as the band for the current step.

Key Path	Source, List Sequencer, List Sequencer Setup, Radio Setup, Radio Standard, GSM/EDGE
Initial S/W Revision	A.05.00

### E-GSM

Selects E-GSM as the band for the current step.

Key Path	Source, List Sequencer, List Sequencer Setup, Radio Setup, Radio Standard, GSM/EDGE
Initial S/W Revision	A.05.00

### R-GSM

Selects R-GSM as the band for the current step.

Key Path	Source, List Sequencer, List Sequencer Setup, Radio Setup, Radio Standard, GSM/EDGE
Initial S/W Revision	A.05.00

### DCS 1800

Selects DCS 1800 as the band for the current step.

Key Path	Source, List Sequencer, List Sequencer Setup, Radio Setup, Radio Standard, GSM/EDGE
Initial S/W Revision	A.05.00

### PCS 1900

Selects PCS 1900 as the band for the current step.

Key Path	Source, List Sequencer, List Sequencer Setup, Radio Setup, Radio Standard, GSM/EDGE
Initial S/W Revision	A.05.00

### GSM 450

Selects GSM 450 as the band for the current step.

Key Path	Source, List Sequencer, List Sequencer Setup, Radio Setup, Radio Standard, GSM/EDGE
Initial S/W Revision	A.05.00

**GSM 480**

Selects GSM 480 as the band for the current step.

Key Path	Source, List Sequencer, List Sequencer Setup, Radio Setup, Radio Standard, GSM/EDGE
Initial S/W Revision	A.05.00

**GSM 850**

Selects GSM 850 as the band for the current step.

Key Path	Source, List Sequencer, List Sequencer Setup, Radio Setup, Radio Standard, GSM/EDGE
Initial S/W Revision	A.05.00

**GSM 700**

Selects GSM 700 as the band for the current step.

Key Path	Source, List Sequencer, List Sequencer Setup, Radio Setup, Radio Standard, GSM/EDGE
Initial S/W Revision	A.05.00

**T-GSM 810**

Selects T-GSM 810 as the band for the current step.

Key Path	Source, List Sequencer, List Sequencer Setup, Radio Setup, Radio Standard, GSM/EDGE
Initial S/W Revision	A.05.00

**WCDMA**

Pressing this key once selects WCDMA as the radio standard and the current WCDMA band as the active channel band. Pressing this key again allows access to the sub-menus for selecting a different WCDMA band.

Key Path	Source, List Sequencer, List Sequencer Setup, Radio Setup, Radio Standard
Initial S/W Revision	A.05.00

**Band I**

Selects Band I as the band for the current step.

---

Key Path	Source, List Sequencer, List Sequencer Setup, Radio Setup, Radio Standard, WCDMA
Initial S/W Revision	A.05.00

---

#### Band II

Selects Band II as the band for the current step.

---

Key Path	Source, List Sequencer, List Sequencer Setup, Radio Setup, Radio Standard, WCDMA
Initial S/W Revision	A.05.00

---

#### Band III

Selects Band III as the band for the current step.

---

Key Path	Source, List Sequencer, List Sequencer Setup, Radio Setup, Radio Standard, WCDMA
Initial S/W Revision	A.05.00

---

#### Band IV

Selects Band IV as the band for the current step.

---

Key Path	Source, List Sequencer, List Sequencer Setup, Radio Setup, Radio Standard, WCDMA
Initial S/W Revision	A.05.00

---

#### Band V

Selects Band V as the band for the current step.

---

Key Path	Source, List Sequencer, List Sequencer Setup, Radio Setup, Radio Standard, WCDMA
Initial S/W Revision	A.05.00

---

#### Band VI

Selects Band VI as the band for the current step.

---

Key Path	Source, List Sequencer, List Sequencer Setup, Radio Setup, Radio Standard, WCDMA
Initial S/W Revision	A.05.00

---

#### Band VII

Selects Band VII as the band for the current step.

---

Key Path	Source, List Sequencer, List Sequencer Setup, Radio Setup, Radio Standard, WCDMA
Initial S/W Revision	A.05.00

---

**Band VIII**

Selects Band VIII as the band for the current step.

---

Key Path	Source, List Sequencer, List Sequencer Setup, Radio Setup, Radio Standard, WCDMA
Initial S/W Revision	A.05.00

---

**Band IX**

Selects Band IX as the band for the current step.

---

Key Path	Source, List Sequencer, List Sequencer Setup, Radio Setup, Radio Standard, WCDMA
Initial S/W Revision	A.05.00

---

**Band X**

Selects Band X as the band for the current step.

---

Key Path	Source, List Sequencer, List Sequencer Setup, Radio Setup, Radio Standard, WCDMA
Initial S/W Revision	A.05.00

---

**Band XI**

Selects Band XI as the band for the current step.

---

Key Path	Source, List Sequencer, List Sequencer Setup, Radio Setup, Radio Standard, WCDMA
Initial S/W Revision	A.05.00

---

**Band XII**

Selects Band XII as the band for the current step.

---

Key Path	Source, List Sequencer, List Sequencer Setup, Radio Setup, Radio Standard, WCDMA
Initial S/W Revision	A.05.00

---

**Band XIII**

Selects Band XIII as the band for the current step.

---

Key Path	Source, List Sequencer, List Sequencer Setup, Radio Setup, Radio Standard, WCDMA
Initial S/W Revision	A.05.00

---

#### Band XIV

Selects Band XIV as the band for the current step.

---

Key Path	Source, List Sequencer, List Sequencer Setup, Radio Setup, Radio Standard, WCDMA
Initial S/W Revision	A.05.00

---

#### LTE

Pressing this key once selects LTE FDD as the radio standard and the current LTE FDD band as the active channel band. Pressing this key again allows access to the sub-menus for selecting a different LTE FDD band.

---

Key Path	Source, List Sequencer, List Sequencer Setup, Radio Setup, Radio Standard
Initial S/W Revision	A.09.50

---

#### BAND 1

Selects BAND 1 as the band for the current step.

---

Key Path	Source, List Sequencer, List Sequencer Setup, Radio Setup, Radio Standard, LTE
Initial S/W Revision	A.09.50

---

#### BAND 2

Selects BAND 2 as the band for the current step.

---

Key Path	Source, List Sequencer, List Sequencer Setup, Radio Setup, Radio Standard, LTE
Initial S/W Revision	A.09.50

---

#### BAND 3

Selects BAND 3 as the band for the current step.

---

Key Path	Source, List Sequencer, List Sequencer Setup, Radio Setup, Radio Standard, LTE
Initial S/W Revision	A.09.50

---



**BAND 4**

Selects BAND 4 as the band for the current step.

Key Path	Source, List Sequencer, List Sequencer Setup, Radio Setup, Radio Standard, LTE
Initial S/W Revision	A.09.50

**BAND 5**

Selects BAND 5 as the band for the current step.

Key Path	Source, List Sequencer, List Sequencer Setup, Radio Setup, Radio Standard, LTE
Initial S/W Revision	A.09.50

**BAND 6**

Selects BAND 6 as the band for the current step.

Key Path	Source, List Sequencer, List Sequencer Setup, Radio Setup, Radio Standard, LTE
Initial S/W Revision	A.09.50

**BAND 7**

Selects BAND 7 as the band for the current step.

Key Path	Source, List Sequencer, List Sequencer Setup, Radio Setup, Radio Standard, LTE
Initial S/W Revision	A.09.50

**BAND 8**

Selects BAND 8 as the band for the current step.

Key Path	Source, List Sequencer, List Sequencer Setup, Radio Setup, Radio Standard, LTE
Initial S/W Revision	A.09.50

**BAND 9**

Selects BAND 9 as the band for the current step.

Key Path	Source, List Sequencer, List Sequencer Setup, Radio Setup, Radio Standard, LTE
Initial S/W Revision	A.09.50

#### BAND 10

Selects BAND 10 as the band for the current step.

Key Path	Source, List Sequencer, List Sequencer Setup, Radio Setup, Radio Standard, LTE
Initial S/W Revision	A.09.50

#### BAND 11

Selects BAND 11 as the band for the current step.

Key Path	Source, List Sequencer, List Sequencer Setup, Radio Setup, Radio Standard, LTE
Initial S/W Revision	A.09.50

#### BAND 12

Selects BAND 12 as the band for the current step.

Key Path	Source, List Sequencer, List Sequencer Setup, Radio Setup, Radio Standard, LTE
Initial S/W Revision	A.09.50

#### BAND 13

Selects BAND 13 as the band for the current step.

Key Path	Source, List Sequencer, List Sequencer Setup, Radio Setup, Radio Standard, LTE
Initial S/W Revision	A.09.50

#### BAND 14

Selects BAND 14 as the band for the current step.

Key Path	Source, List Sequencer, List Sequencer Setup, Radio Setup, Radio Standard, LTE
Initial S/W Revision	A.09.50

#### BAND 17

Selects BAND 17 as the band for the current step.

Key Path	Source, List Sequencer, List Sequencer Setup, Radio Setup, Radio Standard, LTE
Initial S/W Revision	A.09.50

**BAND 18**

Selects BAND 18 as the band for the current step.

Key Path	Source, List Sequencer, List Sequencer Setup, Radio Setup, Radio Standard, LTE
Initial S/W Revision	A.09.50

**BAND 19**

Selects BAND 19 as the band for the current step.

Key Path	Source, List Sequencer, List Sequencer Setup, Radio Setup, Radio Standard, LTE
Initial S/W Revision	A.09.50

**BAND 20**

Selects BAND 20 as the band for the current step.

Key Path	Source, List Sequencer, List Sequencer Setup, Radio Setup, Radio Standard, LTE
Initial S/W Revision	A.09.50

**BAND 21**

Selects BAND 21 as the band for the current step.

Key Path	Source, List Sequencer, List Sequencer Setup, Radio Setup, Radio Standard, LTE
Initial S/W Revision	A.09.50

**BAND 24**

Selects BAND 24 as the band for the current step.

Key Path	Source, List Sequencer, List Sequencer Setup, Radio Setup, Radio Standard, LTE
Initial S/W Revision	A.09.50

**BAND 25**

Selects BAND 25 as the band for the current step.

Key Path	Source, List Sequencer, List Sequencer Setup, Radio Setup, Radio Standard, LTE
Initial S/W Revision	A.09.50

#### BAND 26

Selects BAND 26 as the band for the current step.

Key Path	Source, List Sequencer, List Sequencer Setup, Radio Setup, Radio Standard, LTE
Initial S/W Revision	A.12.53

#### BAND 27

Selects BAND 27 as the band for the current step.

Key Path	Source, List Sequencer, List Sequencer Setup, Radio Setup, Radio Standard, LTE
Initial S/W Revision	A.14.00

#### BAND 28

Selects BAND 28 as the band for the current step.

Key Path	Source, List Sequencer, List Sequencer Setup, Radio Setup, Radio Standard, LTE
Initial S/W Revision	A.14.00

#### BAND 31

Selects BAND 31 as the band for the current step.

Key Path	Source, List Sequencer, List Sequencer Setup, Radio Setup, Radio Standard, LTE
Initial S/W Revision	A.14.00

#### LTE TDD

Sets LTE TDD as the radio standard for use and accesses the LTE TDD specific channel band sub-menus..

Key Path	Source, Frequency, Radio Setup, Radio Standard
Initial S/W Revision	A.11.50

#### BAND 33

Selects BAND 33 as the band for the current step.

Key Path	Source, Frequency, Radio Setup, Radio Standard, LTE TDD
<b>Example</b>	:SOUR:FREQ:CHAN:BAND BAND33
Initial S/W Revision	A.11.50

**BAND 34**

Selects BAND 34 as the band for the current step.

Key Path	Source, Frequency, Radio Setup, Radio Standard, LTE TDD
<b>Example</b>	:SOUR:FREQ:CHAN:BAND BAND34
Initial S/W Revision	A.11.50

**BAND 35**

Selects BAND 35 as the band for the current step.

Key Path	Source, Frequency, Radio Setup, Radio Standard, LTE TDD
<b>Example</b>	:SOUR:FREQ:CHAN:BAND BAND35
Initial S/W Revision	A.11.50

**BAND 36**

Selects BAND 36 as the band for the current step.

Key Path	Source, Frequency, Radio Setup, Radio Standard, LTE TDD
<b>Example</b>	:SOUR:FREQ:CHAN:BAND BAND36
Initial S/W Revision	A.11.50

**BAND 37**

Selects BAND 37 as the band for the current step.

Key Path	Source, Frequency, Radio Setup, Radio Standard, LTE TDD
<b>Example</b>	:SOUR:FREQ:CHAN:BAND BAND37
Initial S/W Revision	A.11.50

**BAND 38**

Selects BAND 38 as the band for the current step.

Key Path	Source, Frequency, Radio Setup, Radio Standard, LTE TDD
<b>Example</b>	:SOUR:FREQ:CHAN:BAND BAND38
Initial S/W Revision	A.11.50

### BAND 39

Selects BAND 39 as the band for the current step.

Key Path	Source, Frequency, Radio Setup, Radio Standard, LTE TDD
<b>Example</b>	:SOUR:FREQ:CHAN:BAND BAND39
Initial S/W Revision	A.11.50

### BAND 40

Selects BAND 40 as the band for the current step.

Key Path	Source, Frequency, Radio Setup, Radio Standard, LTE TDD
<b>Example</b>	:SOUR:FREQ:CHAN:BAND BAND40
Initial S/W Revision	A.11.50

### BAND 41

Selects BAND 41 as the band for the current step.

Key Path	Source, Frequency, Radio Setup, Radio Standard, LTE TDD
<b>Example</b>	:SOUR:FREQ:CHAN:BAND BAND41
Initial S/W Revision	A.11.50

### BAND 42

Selects BAND 42 as the band for the current step.

Key Path	Source, Frequency, Radio Setup, Radio Standard, LTE TDD
<b>Example</b>	:SOUR:FREQ:CHAN:BAND BAND42
Initial S/W Revision	A.11.50

### BAND 43

Selects BAND 43 as the band for the current step.

Key Path	Source, Frequency, Radio Setup, Radio Standard, LTE TDD
<b>Example</b>	:SOUR:FREQ:CHAN:BAND BAND43
Initial S/W Revision	A.11.50

**BAND 44**

Selects BAND 44 as the band for the current step.

Key Path	Source, List Sequencer, List Sequencer Setup, Radio Setup, Radio Standard, LTE TDD
Initial S/W Revision	A.14.00

**TDSCDMA**

Sets TDSCDMA as the radio standard for use and accesses the TDSCDMA specific channel band sub-menus..

Key Path	Source, Frequency, Radio Setup, Radio Standard
Initial S/W Revision	A.11.50

**BAND A**

Selects BAND A as the band for the current step.

Key Path	Source, Frequency, Radio Setup, Radio Standard, TDSCDMA
<b>Example</b>	:SOUR:FREQ:CHAN:BAND BANDA
Initial S/W Revision	A.11.50

**BAND B**

Selects BAND B as the band for the current step.

Key Path	Source, Frequency, Radio Setup, Radio Standard, TDSCDMA
<b>Example</b>	:SOUR:FREQ:CHAN:BAND BANDB
Initial S/W Revision	A.11.50

**BAND C**

Selects BAND C as the band for the current step.

Key Path	Source, Frequency, Radio Setup, Radio Standard, TDSCDMA
<b>Example</b>	:SOUR:FREQ:CHAN:BAND BANDC
Initial S/W Revision	A.11.50

**BAND D**

Selects BAND D as the band for the current step.

Key Path	Source, Frequency, Radio Setup, Radio Standard, TDSCDMA
<b>Example</b>	:SOUR:FREQ:CHAN:BAND BANDD
Initial S/W Revision	A.11.50

#### BAND E

Selects BAND E as the band for the current step.

Key Path	Source, Frequency, Radio Setup, Radio Standard, TDSCDMA
<b>Example</b>	:SOUR:FREQ:CHAN:BAND BANDE
Initial S/W Revision	A.11.50

#### BAND F

Selects BAND F as the band for the current step.

Key Path	Source, Frequency, Radio Setup, Radio Standard, TDSCDMA
<b>Example</b>	:SOUR:FREQ:CHAN:BAND BANDF
Initial S/W Revision	A.11.50

#### Radio Band Link

Allows you to specify the radio band link direction for the steps within the list sequence. The link is used in conjunction with the channel band and channel number to determine the output frequency.

When set to “Uplink”, the source will calculate the uplink frequency according to an uplink formula together with selected channel band and channel number. When set to “Downlink”, the source will calculate the downlink frequency according to a downlink formula together with selected channel band and channel number.

Key Path	Source, List Sequencer, List Sequencer Setup, Radio Setup
<b>Remote Command</b>	:SOURce:LIST:STEP[1] 2 3...1000:SETup:RADio:BAND:LINK DOWN UP :SOURce:LIST:STEP[1] 2 3...1000:SETup:RADio:BAND:LINK?
<b>Example</b>	:SOUR:LIST:STEP2:SET:RAD:BAND:LINK UP :SOUR:LIST:STEP2:SET:RAD:BAND:LINK?
Notes	SCPI is supported after A.09.40
Preset	DOWN
Range	DOWN   UP
Initial S/W Revision	A.05.00



## Channel

Allows you to specify the frequency of the current step via a channel number.

<b>Key Path</b>	Source, List Sequencer, List Sequencer Setup
<b>Remote Command</b>	:SOURce:LIST:STEP[1] 2 3...1000:SETup:CNFRfrequency <double> :SOURce:LIST:STEP[1] 2 3...1000:SETup:CNFRfrequency?
<b>Example</b>	:SOUR:LIST:STEP2:SET:CNFR 124 :SOUR:LIST:STEP2:SET:CNFR?
<b>Notes</b>	SCPI is supported after A.09.40. This SCPI is used to setup channel number or frequency setting, according to current Radio Band setting. If Radio Band is "NONE", then it's frequency. If Radio Band is not "NONE", then it's channel number.
<b>Couplings</b>	The channel number is coupled to the step frequency value. When the step frequency value is changed, the channel number will increase or decrease to match the new step frequency. If the step frequency is not at an exact match for a channel number, the nearest channel number is displayed, along with a greater than, or less than sign to indicate the frequency is above or below the channel number.
<b>Preset</b>	1
<b>Min</b>	0 (Please refer to for valid ranges.)
<b>Max</b>	10838 (Please refer to for valid ranges.)
<b>Initial S/W Revision</b>	A.05.00

## Frequency

Allows you to specify a frequency value for the current step.

<b>Key Path</b>	Source, List Sequencer, List Sequencer Setup
<b>Remote Command</b>	:SOURce:LIST:STEP[1] 2 3...1000:SETup:CNFRfrequency <double> :SOURce:LIST:STEP[1] 2 3...1000:SETup:CNFRfrequency?
<b>Example</b>	:SOUR:LIST:STEP2:SET:CNFR 1GHz :SOUR:LIST:STEP2:SET:CNFR?
<b>Notes</b>	SCPI is supported after A.09.40. This SCPI is used to setup channel number or frequency setting, according to current Radio Band setting. If Radio Band is "NONE", then it's frequency. If Radio Band is not "NONE", then it's channel number.
<b>Couplings</b>	The frequency value is coupled to the channel band and number for the step, such that updates to the radio band and channel number will update the frequency value to the corresponding absolute frequency. The reverse is also true, changing the frequency value causes the value of the channel number to be updated.
<b>Preset</b>	1.00 GHz
<b>Min</b>	10.00 MHz
<b>Max</b>	Hardware Dependant:

	Option 503 = 3.6 GHz Option 504 = 3.9 GHz Option 506 = 6.00 GHz
Initial S/W Revision	A.05.00

## Power

Allows you to specify a power value for the current step.

Key Path	Source, List Sequencer, List Sequencer Setup
Remote Command	:SOURce:LIST:STEP[1] 2 3...1000:SETup:AMPLitude <double> :SOURce:LIST:STEP[1] 2 3...1000:SETup:AMPLitude?
Example	:SOUR:LIST:STEP2:SET:AMPL -50dBm :SOUR:LIST:STEP2:SET:AMPL?
Notes	SCPI is supported after A.09.40
Notes	Amplitude corrections can be specified for use with the source. In the event of amplitude corrections being applied, the valid ranges for the RF power do not change dependant on the current amplitude correction setting. Instead, if the combination of RF power + amplitude correction is higher or lower than the source output range, the Source Unleveled bit is set and the "Source Unleveled" indicator will appear on status panel to indicate that the source cannot maintain the output power that has been requested.  The multiport adapter RFIO TX ports and GPS ports cannot ensure power accuracy when power setting is lower than -130dBm, this power setting value is defined by the sum of RF Power setting and related amplitude correction value. But user settable value could be lower than this limit. When application detected there exists power setting lower than -130dBm on MPA RFIO TX ports, then popup warning message . When application detected there exists power setting lower than -130dBm on MPA GPS ports, then popup warning message . These are only warning messages, and check is performed when RF is ON.
Notes	The Min and Max value here defined UI settable amplitude range. This range is larger than actual amplitude range with level accuracy defined in spec.
Dependencies	The RF power is dependent on the RF output port and frequency, such that the current frequency and selected output port determine the valid range of power values.
Preset	-100 dBm
Min	The range of values depends on the current frequency and selected RF output port. Please refer to "RF Power" on page 1379 and the table RF Power Range for the valid ranges.
Max	The range of values depends on the current frequency and selected RF output port. Please refer to "RF Power" on page 1379 and the table RF Power Range for the valid ranges.
Initial S/W Revision	A.05.00

## Waveform

Allows you access to the sub-menus for selecting the waveform to be played back during the current step. Pressing this key also changes the central display area to show the Waveform File Selection view.

Key Path	Source, List Sequencer, List Sequencer Setup
Remote Command	:SOURce:LIST:STEP[1]   2   3...1000:SETup:WAVeform <string> :SOURce:LIST:STEP[1]   2   3...1000:SETup:WAVeform?
Example	:SOUR:LIST:STEP2:SET:WAV "CW" :SOUR:LIST:STEP2:SET:WAV?
Notes	SCPI is supported after A.09.40
Remote Command Notes	String type, takes "Off"   "CW"   "Cont"   "waveform name"
Preset	CW
Range	Waveform   Continue Previous   CW   Off
Initial S/W Revision	A.05.00

### CW

Sets the current step to output a CW tone.

Key Path	Source, List Sequencer, List Sequencer Setup, Waveform
Example	:SOUR:LIST:STEP2:SET:WAV "CW"
Notes	SCPI is supported after A.09.40
Initial S/W Revision	A.05.00

### Selected Waveform

Inserts the currently selected waveform in the waveform selection view as the waveform for playback during the current step.

Key Path	Source, List Sequencer, List Sequencer Setup, Waveform
Example	:SOUR:LIST:STEP2:SET:WAV "waveform name"
Notes	SCPI is supported after A.09.40 If the selected waveform contains header (which contains ARB play parameters), source list sequence will automatically apply header settings of the selected waveform in that step.
Initial S/W Revision	A.05.00

### Continue Previous

Sets the current step to continue with playback of the waveform from the previous step. When continuing the previous waveform, the ARB playback will not pause while the source retunes to the new frequency or amplitude that may be defined for the new step.

Key Path	Source, List Sequencer, List Sequencer Setup, Waveform
----------	--------------------------------------------------------

<b>Example</b>	:SOUR:LIST:STEP2:SET:WAV "Cont"
<b>Notes</b>	SCPI is supported after A.09.40
<b>Initial S/W Revision</b>	A.05.00

### Off

Disable RF output of the current step.

<b>Key Path</b>	Source, List Sequencer, List Sequencer Setup, Waveform
<b>Example</b>	:SOUR:LIST:STEP2:SET:WAV "Off"
<b>Notes</b>	SCPI is supported after A.09.40
<b>Initial S/W Revision</b>	A.05.00

### Segments on Hard Disk

Allows you access to the sub-menus for loading waveform segments from the hard disk into ARB memory. The default directory is: D: varb.

Pressing this key changes the current view to the Waveform Management View.

<b>Key Path</b>	Source, Modulation Setup, ARB, Select Waveform
<b>Initial S/W Revision</b>	A.05.00

### Load Segment To ARB Memory

Allows you to load the selected file into ARB memory. On the front panel you select the file for loading to the ARB memory by highlighting the desired file in the list. Using the SCPI command, you specify the file name on the HDD.

"NVWFM" (none-volatile storage) MSUS (Mass Storage Unit Specifier) is supported in the memory subsystem because the ARB memory cannot be accessed directly. Therefore, files must be downloaded to the instrument hard disk and then loaded into the ARB memory. "NVWFM" MSUS will be mapped to the default directory D: VARB. The SCPI command supports using either "NVWFM" MSUS or specifying a full path. For more information, see Memory Subsystem (Remote Command Only).

If a file of the same name already exists within ARB memory, it is overwritten. If you wish to load two segments of the same name, you must rename one of the segments before loading it into ARB memory. To rename a segment, you can either use Windows File Explorer, or the :MMEMORY:COPY command.

NOTE: When a waveform file is loaded to ARB memory, burst timing adjustments are made automatically, based on whether or not a Multiport Adapter is connected to the test set and powered on. If the connection/power status of the Multiport Adapter is changed after a waveform file has been loaded, it needs to be loaded again.

Key Path	Source, Modulation Setup, ARB, Select Waveform, Segments on Hard Disk
Remote Command	:SOURce:RADio:ARB:LOAD <string>
Example	:SOUR:RAD:ARB:LOAD "D: VARB\testwaveform.bin" or :SOUR:RAD:ARB:LOAD "NVWFM:testwaveform.bin"
Notes	<p>Because loading the file involves a delay of unpredictable length, this command should be followed by the query *OPC?, which holds off subsequent commands until the loading operation is complete.</p> <p>&lt;string&gt; – specifies the path name of the file to load from the HDD into ARB memory. It could be a &lt;full path + filename&gt;, or &lt;"NVWFM" MSUS + colon + filename&gt;.</p> <p>When in Sequence Analyzer mode, and Include Source is Yes, an attempt to load a file to ARB memory will be rejected with an error.</p> <p>When Include Source is No and if there is insufficient free ARB memory to load the selected waveform, an error is generated. .</p> <p>If you specify a file over SCPI, but the file is not at the specified location, an error is generated.</p> <p>If you try to load a waveform file but the file contains less than 500 IQ samples, an error is generated.</p> <p>If you try to load a Signal Studio waveform "*.wfm" which contains invalid waveform header, an error is generated.</p> <p>If the ARB is ON when you load a file to ARB memory or delete a file from ARB memory, the playing waveform segment may not keep phase continuity during the ARB memory operation. The waveform will be replayed after the ARB operation is finished.</p> <p>ARB can be loaded into ARB memory even if required licenses do not present on the instrument. In this case, a GUI only warning message –800, "Operation complete; Loaded &lt;filename&gt; successfully, but no license &lt;required licenses&gt; installed". User can install required licenses according to &lt;required licenses&gt; string to license it, or multi-pack license it.</p>
Initial S/W Revision	A.05.00

### Load All To ARB Memory

Allows you to load all the segment files within the currently selected directory into ARB memory. If a file of the same name already exists within ARB memory, it is overwritten. If you wish to load two segments of the same name, you must rename one of the segments before loading it into ARB memory. To rename a segment, you can either use Windows File Explorer, or the :MEMory:COPY command.

NOTE: When a waveform file is loaded to ARB memory, burst timing adjustments are made automatically, based on whether or not a Multiport Adapter is connected to the test set and powered on. If the connection/power status of the Multiport Adapter is changed after a waveform file has been loaded, it needs to be loaded again.

Key Path	Source, Modulation Setup, ARB, Select Waveform, Segments on Hard Disk
Remote Command	:SOURce:RADio:ARB:LOAD:ALL <string>
Example	:SOUR:RAD:ARB:LOAD:ALL "D: varb"
Notes	<p>&lt;string&gt; - specifies the directory on the HDD to load the files into ARB memory from.</p> <p>When in Sequence Analyzer mode, and Include Source is Yes, an attempt to load all files from a directory to ARB memory is rejected with an error.</p>

When Include Source is No and there is insufficient free ARB memory to load all the waveforms, when the ARB memory is full, the copy ceases, and an error is generated.  
If you specify a directory over SCPI, but the directory does not exist, an error is generated.  
If the ARB is ON, a user then loads or deletes file to ARB memory, the playing waveform segment may not keep phase continuity during the ARB memory operation. The waveform will be replayed after the ARB operation is finished.

Initial S/W Revision	A.05.00
----------------------	---------

### Change Directory...

Allows you to change the currently selected directory on the hard disk. Pressing this key opens a standard windows change directory dialog allowing you to select the new directory of interest.

The current directory is used for manually loading waveform segments into ARB memory for playback, and as a search location for waveform segments that are required to be loaded into ARB memory for playback of a waveform sequence or a list sequence.

Key Path	Source, Modulation Setup, ARB, Select Waveform, Segments on Hard Disk
Notes	No remote command, SCPI front panel only.
Initial S/W Revision	A.05.00

### Default Directory...

Allows you to change the default directory. It is used as a search location for waveform segments that are required to be loaded into ARB memory for playback of a waveform sequence, and as a search location for selecting waveforms using SCPI.

Key Path	Source, Modulation Setup, ARB, Select Waveform, Segments on Hard Disk
<b>Remote Command</b>	:SOURce:RADio:ARB:DEFault:DIRectory <string> :SOURce:RADio:ARB: DEFault:DIRectory?
<b>Example</b>	:SOUR:RAD:ARB:DEF:DIR "D:\ArbFiles" :SOUR:RAD:ARB:DEF:DIR?
State Saved	Persistent, survives a power cycle and a preset but not saved in the instrument state
Initial S/W Revision	A.05.00

### Segments in ARB Memory

Allows you access to the sub-menus for managing the files within ARB memory.

Key Path	Source, Modulation Setup, ARB, Select Waveform
Initial S/W Revision	A.05.00

## Delete Segment From ARB Mem

Allows you to remove a segment from ARB playback memory.

Key Path	Source, Modulation Setup, ARB, Select Waveform, Segments in ARB Memory
Remote Command	:SOURce:RADio:ARB:DELeTe <string>
Example	:SOUR:RAD:ARB:DEL "testwaveform.bin"
Notes	<p>&lt;string&gt; - specifies the waveform to be deleted from the ARB playback memory.</p> <p>When in Sequence Analyzer mode and Include Source is Yes, an attempt to delete a file from ARB memory is rejected with an error.</p> <p>When Include Source is No and you specify a file that does not exist within ARB memory, an error is generated.</p> <p>It is possible to delete files from within the ARB memory when the ARB is ON. However, if you attempt to delete the file that is currently playing an error is generated.</p> <p>It is possible to delete a file from within the ARB memory when the sequencer state is ON and the file is not being used by the List Sequencer. If you attempt to delete a file which is being used by the list sequencer, an error is generated.</p> <p>When sequencer state is On, even if ARB state is On, the selected waveform will not be played. In this case, if the selected waveform is not used in List Sequence, it can be deleted and the ARB state is turned Off.</p> <p>If the ARB is ON and you load a file to ARB memory or delete a file from ARB memory, the playing waveform segment may not keep phase continuity during the ARB memory operation. The waveform will be replayed after the ARB operation is finished.</p>
Initial S/W Revision	A.05.00

## Delete All From ARB Memory

Allows you to remove all segments from ARB playback memory.

Key Path	Source, Modulation Setup, ARB, Select Waveform, Segments in ARB Memory
Remote Command	:SOURce:RADio:ARB:DELeTe:ALL
Example	:SOUR:RAD:ARB:DELeTe:ALL
Notes	<p>When in Sequence Analyzer mode and Include Source is Yes, an attempt to delete all files from ARB memory is rejected with an error.</p> <p>When Include Source is No and you attempt to delete all files from ARB memory when the ARB is currently playing a file, all files except the one playing are deleted and an error is generated.</p> <p>If you attempt to delete all files from ARB memory when there are waveform files used in "<a href="#">List Sequencer</a>" on page 1449 and "<a href="#">Sequencer</a>" on page 1449 state is ON, all files except the files currently being used in list sequencer are deleted, and an error is generated.</p> <p>If the ARB is ON and you load a file to ARB memory or delete a file from ARB memory, the playing waveform segment may not keep phase continuity during the ARB memory operation. The waveform will be replayed after the ARB operation is finished.</p>
Initial S/W Revision	A.05.00

## Step Duration

Allows access to the sub-menus for setting up the duration of play for the current step.

The duration can be set to be either the number of times for the ARB file associated with the sequence to play, or a specific time value, or continuous. If the step is set to play a CW tone, the step duration cannot be set to a play count.

<b>Key Path</b>	Source, List Sequencer, List Sequencer Setup
<b>Remote Command</b>	:SOURce:LIST:STEP[1] 2 3...1000:SETup:DURation:TYPE TIME   COUNT   CONTinuous   CABort  :SOURce:LIST:STEP[1] 2 3...1000:SETup:DURation:TYPE?
<b>Example</b>	:SOUR:LIST:STEP2:SET:DUR:TYPE TIME :SOUR:LIST:STEP2:SET:DUR:TYPE?
<b>Notes</b>	SCPI is supported after A.09.40
<b>Notes</b>	If “Step Duration” is set to “Time” or “Play Count” for the last step, the last step of ARB keeps playing as if set to “Continuous”, until the set “Time” has expired or until the “Play Count” setting is reached. However, you can query <b>Error! Reference source not found.</b> Source Sweeping Condition Message to find out if the current list sequence is complete or not.
<b>Range</b>	Time   Play Count   Continuous   Continuous Abort
<b>Initial S/W Revision</b>	A.05.00

## Time

Sets the duration of the current step to be a time value for the length of time the step will play. Pressing this key again opens another menu which allows you to set the time value for the step duration.

<b>Key Path</b>	Source, List Sequencer, List Sequencer Setup, Step Duration
<b>Example</b>	:SOUR:LIST:STEP2:SET:DUR:TYPE TIME
<b>Notes</b>	SCPI is supported after A.09.40
<b>Initial S/W Revision</b>	A.05.00

## Duration Time

Allows you to specify the length of time the current step will play.

If the Transition Time value is longer than the Step Duration Time, an error is generated when initiating a source list sequence. For source list sequence, transition time is included in the step duration length (not occupy additional time). If the Transition Time value is longer than the Step Duration Time, the real step duration length is extended to equal the transition time and cause a timing shift. This check is also described in section **Error! Reference source not found.** List Sequence Step Validation.

<b>Key Path</b>	Source, List Sequencer, List Sequencer Setup, Step Duration, Time
<b>Remote Command</b>	:SOURce:LIST:STEP[1] 2 3...1000:SETup:DURation:TCOUNT <double> :SOURce:LIST:STEP[1] 2 3...1000:SETup:DURation:TCOUNT?



<b>Example</b>	:SOUR:LIST:STEP2:SET:DUR:TCO 1s :SOUR:LIST:STEP2:SET:DUR:TCO?
Notes	SCPI is supported after A.09.40 This SCPI is reused by "Play Count", "Duration Time" and "Continuous Abort" according to current Duration Type setting is "Play Count" or "Duration Time" or "Continuous Abort". If current "Duration Type" is "Continuous", then popup error -221, "Settings conflict;Cannot accept time or count input when step duration type is Continuous on step #"
Notes	If "Duration Time" is set for the last step, the last step of ARB keeps playing as if set to "Continuous" after set time expires. However, you can query Source Sweeping Condition Message (:STAT:OPER:COND?) to find out if the current list sequence is complete or not.
Preset	1.00 ms
Min	100 $\mu$ s
Max	1800 s
Initial S/W Revision	A.05.00

### Play Count

Sets the duration of the current step to be an integer value for the number of times (play count) the ARB file is selected for playback during this step. For example, a 5 second ARB will be set to play 5 times during the step.

<b>Key Path</b>	Source, List Sequencer, List Sequencer Setup, Step Duration
<b>Example</b>	:SOUR:LIST:STEP2:SET:DUR:TYPE COUN
Notes	SCPI is supported after A.09.40 This key is unavailable and is grayed out if the current step is configured to CW tone rather than an ARB waveform.
Initial S/W Revision	A.05.00

### Header Utilities

Allows access to the header utilities sub-menu. Pressing this key also causes the central display area to change to display the File Header Information view.

<b>Key Path</b>	Source, Modulation Setup, ARB
Dependencies	This key is only available if there is currently a waveform selected for playback. If no waveform is selected, the key is grayed out.
Initial S/W Revision	A.05.00

### Continuous

Sets the current step to be played continuously until the next step starts. The waveform will always play completely before transitioning to the next step.

Key Path	Source, List Sequencer, List Sequencer Setup, Step Duration
<b>Example</b>	:SOUR:LIST:STEP2:SET:DUR:TYPE CONT
Notes	SCPI is supported after A.09.40
Initial S/W Revision	A.05.00

### Output Trigger

Allows you to specify the trigger output for the current step. The trigger output signal is sent at the start of the step.

When select “On”, trigger event will occur on both Internal and External2 paths. Select “Off” will turn off trigger output.

Key Path	Source, List Sequencer, List Sequencer Setup
<b>Remote Command</b>	:SOURce:LIST:STEP [1]   2   3...1000:SETup:OUTPut:TRIGger ON   OFF   1   0 :SOURce:LIST:STEP [1]   2   3...1000:SETup:OUTPut:TRIGger
<b>Example</b>	:SOUR:LIST:STEP2:SET:OUTP:TRIG ON :SOUR:LIST:STEP2:SET:OUTP:TRIG?
Notes	SCPI is supported after A.09.40
Preset	Off
Range	On Off
Initial S/W Revision	A.05.00

### Repetition

Allows access to the sub-menu for selecting the repetition type for the list sequencer globally. It cannot be changed between different sequence steps.

Key Path	Source, List Sequencer
<b>Remote Command</b>	:SOURce:LIST:REPetition:TYPE SINGLE CONTInuous
<b>Example</b>	:SOUR:LIST:REP:TYPE SING :SOUR:LIST:REP:TYPE?
Preset	SINGLE
Range	SINGLE CONTInuous
Initial S/W Revision	A.14.50

### Single

Sets the repetition type as single for the whole source sequence. Source list will play one time after initiation.

Key Path	Source, List Sequencer, Repetition
<b>Example</b>	:SOUR:LIST:REP:TYPE SINGLE
Initial S/W Revision	A.14.50

### Continuous

Sets the repetition type as continuous for the whole source sequence. Source list will play continuously after initiation.

Key Path	Source, List Sequencer, Repetition
<b>Example</b>	:SOUR:LIST:REP:TYPE CONTInuous
Initial S/W Revision	A.14.50

### Trigger Type

Allows access to the sub-menu for selecting the output trigger type for the list sequencer globally. It cannot be changed between different sequence steps.

Key Path	Source, List Sequencer
<b>Remote Command</b>	:SOURce:LIST:TRIGgerout:TYPe BEGInningofstep DATamarker
<b>Example</b>	:SOUR:LIST:TRIG:TYP BEG :SOUR:LIST:TRIG:TYP?
Notes	SCPI is supported after A.14.00
Preset	BEGInningofstep
Range	BEGInningofstep DATamarker
Initial S/W Revision	A.14.00

### BeginningOfStep

Sets the output trigger type as BeginningOfStep for the whole source sequence.

Key Path	Source, List Sequencer, Trigger Type
<b>Example</b>	:SOUR:LIST:TRIG:TYP BEG
Notes	SCPI is supported after A.14.00
Initial S/W Revision	A.14.00

### DataMarker

Sets the output trigger type as DataMarker for the whole source sequence. When DataMarker is selected, which marker to route is also needed to be set.

Key Path	Source, List Sequencer, Trigger Type
<b>Example</b>	:SOUR:LIST:TRIG:TYP DAT
Notes	SCPI is supported after A.14.00
Initial S/W Revision	A.14.00

### Marker 1

Sets the output trigger maker routing to Marker 1 for DataMarker in the whole source sequence.

Key Path	Source, List Sequencer, Trigger Type, DataMarker
<b>Example</b>	:SOUR:LIST:TRIG:TYPE:MARK M1
Notes	SCPI is supported after A.14.00
Initial S/W Revision	A.14.00

### Marker 2

Sets the output trigger maker routing to Marker 2 for DataMarker in the whole source sequence.

Key Path	Source, List Sequencer, Trigger Type, DataMarker
<b>Example</b>	:SOUR:LIST:TRIG:TYPE:MARK M2
Notes	SCPI is supported after A.14.00
Initial S/W Revision	A.14.00

### Marker 3

Sets the output trigger maker routing to Marker 3 for DataMarker in the whole source sequence.

Key Path	Source, List Sequencer, Trigger Type, DataMarker
<b>Example</b>	:SOUR:LIST:TRIG:TYPE:MARK M3
Notes	SCPI is supported after A.14.00
Initial S/W Revision	A.14.00

### Marker 4

Sets the output trigger maker routing to Marker 4 for DataMarker in the whole source sequence.

Key Path	Source, List Sequencer, Trigger Type, DataMarker
<b>Example</b>	:SOUR:LIST:TRIG:TYPE:MARK M4
Notes	SCPI is supported after A.14.00
Initial S/W Revision	A.14.00

### Manual Trigger Now

Pressing this key provides a software trigger event to the list sequencer. During execution of sequence, if the sequencer is halted on any step that has been configured with a “Manual” step trigger, then this key press will cause the sequencer to continue and execute the step.

Key Path	Source, List Sequencer
<b>Remote Command</b>	No remote command, front panel only.
Initial S/W Revision	A.05.00

### Source Preset

Allows you to preset the source settings to their default values.

Key Path	Source
<b>Remote Command</b>	:SOURce:PRESet
<b>Example</b>	:SOUR:PRES

## SPAN X Scale

The SPAN/X Scale key accesses the menu that enables you to set the desired horizontal scale and associated settings. The settings available vary depending on the active window focus. For certain active window types, the menu is blank.

Key Path	Front-Panel
Initial S/W Revision	Prior to A.02.00

### Ref Value

Sets the reference value for the x-axis of the windows listed below, which are explained in greater detail in the following sections.

**NOTE** The settings available vary depending on the active window displayed.

Key Path	SPAN X Scale
Initial S/W Revision	Prior to A.02.00

### Ref Value (Error vs. Subcarrier Window)

Ref Value sets the reference value for the x-axis in the Symbol Error vs. Subcarrier window of the Symbol Error view.

Key Path	SPAN/X Scale
Mode	WiMAXOFDMA
<b>Remote Command</b>	:DISPlay:EVM:VIEW3:WINDow[1]:TRACe:X[:SCALE]:RLEVel <real> :DISPlay:EVM:VIEW3:WINDow[1]:TRACe:X[:SCALE]:RLEVel?
<b>Example</b>	DISP:EVM:VIEW3:WIND:TRAC:X:RLEV 0 DISP:EVM:VIEW3:WIND:TRAC:X:RLEV?
Notes	When Auto Scaling is On, this value is automatically determined by the measurement result. The value is switched depending on Scale Type.
Couplings	When this value is set manually, Auto Scaling is set to Off.
Preset	0.0
State Saved	Saved in instrument state.
Min	-5000.0
Max	5000.0
Initial S/W Revision	Prior to A.02.00

### Ref Value (Symbol Power vs. Subcarrier Window)

Ref Value sets the reference value for the x-axis in the Symbol Power vs. Subcarrier window of the Symbol Power view.

Key Path	SPAN/X Scale
Mode	WiMAXOFDMA
<b>Remote Command</b>	:DISPlay:EVM:VIEW4:WINDow[1]:TRACe:X[:SCALe]:RLEVel <real> :DISPlay:EVM:VIEW4:WINDow[1]:TRACe:X[:SCALe]:RLEVel?
<b>Example</b>	DISP:EVM:VIEW4:WIND:TRAC:X:RLEV 0 DISP:EVM:VIEW4:WIND:TRAC:X:RLEV?
Notes	When Auto Scaling is On, this value is automatically determined by the measurement result. The value is switched depending on Scale Type.
Couplings	When this value is set manually, Auto Scaling is set to Off.
Preset	0.0
State Saved	Saved in instrument state.
Min	-5000.0
Max	5000.0
Initial S/W Revision	Prior to A.02.00

### Ref Value (Absolute Flatness Window/Differential Flatness Window)

Ref Value sets the reference value for the x-axis in the Absolute Flatness and Differential Flatness windows of the Spectral Flatness view.

Key Path	SPAN/X Scale
Mode	WiMAXOFDMA
<b>Remote Command</b>	:DISPlay:EVM:VIEW6:WINDow[1] 2:TRACe:X[:SCALe]:RLEVel <real> :DISPlay:EVM:VIEW6:WINDow[1] 2:TRACe:X[:SCALe]:RLEVel?
<b>Example</b>	DISP:EVM:VIEW6:WIND:TRAC:X:RLEV 0 DISP:EVM:VIEW6:WIND:TRAC:X:RLEV?
Notes	When Auto Scaling is On, this value is automatically determined by the measurement result. The value is switched depending on Scale Type.
Couplings	When this value is set manually, Auto Scaling is set to Off. Values of WIND[1] and WIND2 are ALWAYS coupled with each other.
Preset	0.0
State Saved	Saved in instrument state.
Min	-5000.0
Max	5000.0
Initial S/W Revision	Prior to A.02.00

### Ref Value (Power vs Time Window)

Ref Value sets the reference value for the x-axis in the Power vs. Time window of the Power vs. Time & Spectrum view.

Key Path	SPAN X Scale
Mode	WIMAXOFDMA
Remote Command	:DISPlay:EVM:VIEW7:WINDow[1]:TRACe:X[:SCALE]:RLEVel <time> :DISPlay:EVM:VIEW7:WINDow[1]:TRACe:X[:SCALE]:RLEVel?
Example	DISP:EVM:VIEW7:WIND:TRAC:X:RLEV 1 DISP:EVM:VIEW7:WIND:TRAC:X:RLEV?
Notes	When Auto Scaling is On, this value is automatically determined by the measurement result. The value is switched depending on Scale Type. You must be in the WIMAXOFDMA mode to use this command. Use INSTRument:SELEct to set the mode.
Couplings	When this value is set manually, Auto Scaling is set to Off.
Preset	0 s
State Saved	Saved in instrument state.
Min	-20 s
Max	20 s
Initial S/W Revision	Prior to A.02.00

### Ref Value (Symbol Error vs. Symbol Window)

Ref Value sets the reference value for the x-axis in the Symbol Error vs. Symbol window of the Symbol Error view.

Key Path	SPAN/X Scale
Mode	WiMAXOFDMA
Remote Command	:DISPlay:EVM:VIEW3:WINDow2:TRACe:X[:SCALE]:RLEVel <real> :DISPlay:EVM:VIEW3:WINDow2:TRACe:X[:SCALE]:RLEVel?
Example	DISP:EVM:VIEW3:WIND2:TRAC:X:RLEV 0 DISP:EVM:VIEW3:WIND2:TRAC:X:RLEV?
Notes	When Auto Scaling is On, this value is automatically determined by the measurement result. The value is switched depending on Scale Type.
Couplings	When this value is set manually, Auto Scaling is set to Off.
Preset	0.0
State Saved	Saved in instrument state.
Min	-5000
Max	5000
Initial S/W Revision	Prior to A.02.00



### Ref Value (Symbol Power vs. Symbol Window)

Ref Value sets the reference value for the x-axis in the Symbol Power vs. Symbol window of the Symbol Power view.

Key Path	SPAN/X Scale
Mode	WiMAXOFDMA
<b>Remote Command</b>	:DISPlay:EVM:VIEW4:WINDow2:TRACe:X[:SCALE]:RLEVel <real> :DISPlay:EVM:VIEW4:WINDow2:TRACe:X[:SCALE]:RLEVel?
<b>Example</b>	DISP:EVM:VIEW4:WIND2:TRAC:X:RLEV 0 DISP:EVM:VIEW4:WIND2:TRAC:X:RLEV?
Notes	When Auto Scaling is On, this value is automatically determined by the measurement result. The value is switched depending on Scale Type.
Couplings	When this value is set manually, Auto Scaling is set to Off.
Preset	0.0
State Saved	Saved in instrument state.
Min	-5000
Max	5000
Initial S/W Revision	Prior to A.02.00

### Scale/Div

Sets the horizontal scale by changing a value per division of the windows listed below, which are explained in greater detail in the following sections. NOTE: The settings available vary depending on the active window displayed.

Key Path	SPAN X Scale
Initial S/W Revision	Prior to A.02.00

### Scale/Div (Symbol Error vs. Subcarrier Window)

Scale/Div sets the horizontal scale by changing a value per division in the Symbol Error vs. Subcarrier window of the Symbol Error view.

Key Path	SPAN/X Scale
Mode	WiMAXOFDMA
<b>Remote Command</b>	:DISPlay:EVM:VIEW3:WINDow[1]:TRACe:X[:SCALE]:PDIVision <real> :DISPlay:EVM:VIEW3:WINDow[1]:TRACe:X[:SCALE]:PDIVision?
<b>Example</b>	DISP:EVM:VIEW3:WIND:TRAC:X:PDIV 84 DISP:EVM:VIEW3:WIND:TRAC:X:PDIV?

Notes	When Auto Scaling is On, this value is automatically determined by the measurement result. The value is switched depending on Scale Type.
Couplings	When this value is set manually, Auto Scaling is set to Off.
Preset	84
State Saved	Saved in instrument state.
Min	1.0
Max	500.0
Initial S/W Revision	Prior to A.02.00

### Scale/Div (Symbol Power vs. Subcarrier Window)

Scale/Div sets the horizontal scale by changing a value per division in the Symbol Power vs. Subcarrier window of the Symbol Power view.

Key Path	SPAN/X Scale
Mode	WiMAXOFDMA
<b>Remote Command</b>	:DISPlay:EVM:VIEW4:WINDow[1]:TRACe:X[:SCALE]:PDIVision <real> :DISPlay:EVM:VIEW4:WINDow[1]:TRACe:X[:SCALE]:PDIVision?
<b>Example</b>	DISP:EVM:VIEW4:WIND:TRAC:X:PDIV 84 DISP:EVM:VIEW4:WIND:TRAC:X:PDIV?
Notes	When Auto Scaling is On, this value is automatically determined by the measurement result. The value is switched depending on Scale Type.
Couplings	When this value is set manually, Auto Scaling is set to Off.
Preset	84
State Saved	Saved in instrument state.
Min	1.0
Max	500.0
Initial S/W Revision	Prior to A.02.00

### Scale/Div (Absolute Flatness/Differential Flatness Window)

Scale/Div sets the horizontal scale by changing a value per division in the Absolute Flatness and Differential Flatness windows of the Spectral Flatness view.

Key Path	SPAN/X Scale
Mode	WiMAXOFDMA
<b>Remote Command</b>	:DISPlay:EVM:VIEW6:WINDow[1] 2:TRACe:X[:SCALE]:PDIVision <real> :DISPlay:EVM:VIEW6:WINDow[1] 2:TRACe:X[:SCALE]:PDIVision?
<b>Example</b>	DISP:EVM:VIEW6:WIND:TRAC:X:PDIV 10

	DISP:EVM:VIEW6:WIND:TRAC:X:PDIV?
Notes	When Auto Scaling is On, this value is automatically determined by the measurement result. The value is switched depending on Scale Type.
Couplings	When this value is set manually, Auto Scaling is set to Off. Values of WIND[1] and WIND2 are ALWAYS coupled with each other.
Preset	84
State Saved	Saved in instrument state.
Min	1
Max	500
Initial S/W Revision	Prior to A.02.00

### Scale/Div (Power vs Time Window)

Scale/Div sets the horizontal scale by changing a value per division in the Power vs. Time window of the Power vs. Time & Spectrum view.

Key Path	SPAN X Scale
Mode	WIMAXOFDMA
<b>Remote Command</b>	:DISPlay:EVM:VIEW7:WINDow[1]:TRACe:X[:SCALe]:PDIVision <time> :DISPlay:EVM:VIEW7:WINDow[1]:TRACe:X[:SCALe]:PDIVision?
<b>Example</b>	DISP:EVM:VIEW7:WIND:TRAC:X:PDIV 1e-3 DISP:EVM:VIEW7:WIND:TRAC:X:PDIV?
Notes	If the Error! Hyperlink reference not valid. is On, this value is automatically determined by the measurement result.
Couplings	When you set a value manually, Error! Hyperlink reference not valid. automatically changes to Off.
Preset	84.0 us
State Saved	Saved in instrument state.
Min	1.00 ns
Max	1.00 s
Initial S/W Revision	Prior to A.02.00

### Scale/Div (Symbol Error vs. Symbol Window)

Scale/Div sets the horizontal scale by changing a value per division in the Symbol Error vs. Symbol window of the Symbol Error view.

Key Path	SPAN/X Scale
Mode	WiMAXOFDMA
<b>Remote Command</b>	:DISPlay:EVM:VIEW3:WINDow2:TRACe:X[:SCALe]:PDIVision <real>

	:DISPlay:EVM:VIEW3:WINDow2:TRACe:X[:SCALe]:PDIVision?
<b>Example</b>	DISP:EVM:VIEW3:WIND2:TRAC:X:PDIV 1 DISP:EVM:VIEW3:WIND2:TRAC:X:PDIV?
<b>Notes</b>	When Auto Scaling is On, this value is automatically determined by the measurement result. The value is switched depending on Scale Type.
<b>Couplings</b>	When this value is set manually, Auto Scaling is set to Off.
<b>Preset</b>	2
<b>State Saved</b>	Saved in instrument state.
<b>Min</b>	1
<b>Max</b>	10
<b>Initial S/W Revision</b>	Prior to A.02.00

### Scale/Div (Symbol Power vs. Symbol Window)

Scale/Div sets the horizontal scale by changing a value per division in the Symbol Power vs. Symbol window of the Symbol Power view.

<b>Key Path</b>	SPAN/X Scale
<b>Mode</b>	WiMAXOFDMA
<b>Remote Command</b>	:DISPlay:EVM:VIEW4:WINDow2:TRACe:X[:SCALe]:PDIVision <real> :DISPlay:EVM:VIEW4:WINDow2:TRACe:X[:SCALe]:PDIVision?
<b>Example</b>	DISP:EVM:VIEW4:WIND2:TRAC:X:PDIV 1 DISP:EVM:VIEW4:WIND2:TRAC:X:PDIV?
<b>Notes</b>	When Auto Scaling is On, this value is automatically determined by the measurement result. The value is switched depending on Scale Type.
<b>Couplings</b>	When this value is set manually, Auto Scaling is set to Off.
<b>Preset</b>	2
<b>State Saved</b>	Saved in instrument state.
<b>Min</b>	1
<b>Max</b>	10
<b>Initial S/W Revision</b>	Prior to A.02.00

### Ref Position

Sets the reference position for the x-axis to the left, center, or right in the display of the windows listed below, which are explained in greater detail in the following sections:

<b>Key Path</b>	SPAN X Scale
<b>Initial S/W Revision</b>	Prior to A.02.00

### Ref Position (Symbol Error vs. Subcarrier Window)

Ref Position sets the reference position for the x-axis to the left, center, or right in the display of the Symbol Error vs. Subcarrier window of the Symbol Error view.

Key Path	SPAN X Scale
Mode	WIMAXOFDMA
Remote Command	:DISPlay:EVM:VIEW3:WINDow[1]:TRACe:X[:SCALe]:RPOSition LEFT   CENTER   RIGHT :DISPlay:EVM:VIEW3:WINDow[1]:TRACe:X[:SCALe]:RPOSition?
Example	DISP:EVM:VIEW3:WIND:TRAC:X:RPOS LEFT DISP:EVM:VIEW3:WIND:TRAC:X:RPOS?
Preset	CENTER
State Saved	Saved in instrument state.
Range	Left Ctr Right
Initial S/W Revision	Prior to A.02.00

### Ref Position (Symbol Power vs. Subcarrier Window)

Ref Position sets the reference position for the x-axis to the left, center, or right in the display of the Symbol Power vs. Subcarrier window of the Symbol Power view.

Key Path	SPAN X Scale
Mode	WIMAXOFDMA
Remote Command	:DISPlay:EVM:VIEW4:WINDow[1]:TRACe:X[:SCALe]:RPOSition LEFT   CENTER   RIGHT :DISPlay:EVM:VIEW4:WINDow[1]:TRACe:X[:SCALe]:RPOSition?
Example	DISP:EVM:VIEW4:WIND:TRAC:X:RPOS LEFT DISP:EVM:VIEW4:WIND:TRAC:X:RPOS?
Preset	CENTER
State Saved	Saved in instrument state.
Range	Left Ctr Right
Initial S/W Revision	Prior to A.02.00

### Ref Position (Absolute Flatness/Differential Flatness Window)

Ref Position sets the reference position for the x-axis to the left, center, or right in the display of the Absolute Flatness and Differential Flatness windows of the Spectral Flatness view.

Key Path	SPAN X Scale
----------	--------------

Mode	WIMAXOFDMA
Remote Command	:DISPlay:EVM:VIEW6:WINDow[1] 2:TRACe:X[:SCALe]:RPOSition LEFT   CENTer   RIGHT  :DISPlay:EVM:VIEW6:WINDow[1] 2:TRACe:X[:SCALe]:RPOSition?
Example	DISP:EVM:VIEW6:WIND2:TRAC:X:RPOS LEFT DISP:EVM:VIEW6:WIND2:TRAC:X:RPOS?
Couplings	Values of WIND[1] and WIND2 are ALWAYS coupled with each other.
Preset	CENTER
State Saved	Saved in instrument state.
Range	Left Ctr Right
Initial S/W Revision	Prior to A.02.00

### Ref Position (Power vs Time Window)

Ref Position sets the reference position for the x-axis to the left, center, or right in the display of the Symbol Error vs. Subcarrier window of the Symbol Error view.

Key Path	SPAN X Scale
Mode	WIMAXOFDMA
Remote Command	:DISPlay:EVM:VIEW7:WINDow[1]:TRACe:X[:SCALe]:RPOSition LEFT   CENTer   RIGHT  :DISPlay:EVM:VIEW7:WINDow[1]:TRACe:X[:SCALe]:RPOSition?
Example	DISP:EVM:VIEW7:WIND:TRAC:X:RPOS LEFT DISP:EVM:VIEW7:WIND:TRAC:X:RPOS?
Preset	LEFT
State Saved	Saved in instrument state.
Range	Left Ctr Right
Initial S/W Revision	Prior to A.02.00

### Ref Position (Symbol Error vs Symbol Window)

Ref Position sets the reference position for the x-axis to the left, center, or right in the display of the Symbol Error vs. Symbol window of the Symbol Error view.

Key Path	SPAN X Scale
Mode	WIMAXOFDMA
Remote Command	:DISPlay:EVM:VIEW3:WINDow2:TRACe:X[:SCALe]:RPOSition LEFT   CENTer   RIGHT  :DISPlay:EVM:VIEW3:WINDow2:TRACe:X[:SCALe]:RPOSition?
Example	DISP:EVM:VIEW3:WIND2:TRAC:X:RPOS LEFT

	DISP:EVM:VIEW3:WIND2:TRAC:X:RPOS?
Preset	LEFT
State Saved	Saved in instrument state.
Range	Left Ctr Right
Initial S/W Revision	Prior to A.02.00

### Ref Position (Symbol Power vs Symbol Window)

Ref Position sets the reference position for the x-axis to the left, center, or right in the display of the Symbol Power vs. Symbol window of the Symbol Power view.

Key Path	SPAN X Scale
Mode	WIMAXOFDMA
<b>Remote Command</b>	:DISPlay:EVM:VIEW4:WINDow2:TRACe:X[:SCALe]:RPOSition LEFT   CENTer   RIGHT :DISPlay:EVM:VIEW4:WINDow2:TRACe:X[:SCALe]:RPOSition?
<b>Example</b>	DISP:EVM:VIEW4:WIND2:TRAC:X:RPOS LEFT DISP:EVM:VIEW4:WIND2:TRAC:X:RPOS?
Preset	LEFT
State Saved	Saved in instrument state.
Range	Left Ctr Right
Initial S/W Revision	Prior to A.02.00

### Auto Scaling

Toggles the Auto Scaling function between On and Off in the windows listed below, which are explained in greater detail in the following sections:

Key Path	SPAN X Scale
Initial S/W Revision	Prior to A.02.00

### AutoScaling (Symbol Error vs. Subcarrier Window)

Toggles the Auto Scaling function between On and Off in the Symbol Error vs. Subcarrier window of the Symbol Error view.

Key Path	SPAN X Scale
Mode	WIMAXOFDMA
<b>Remote Command</b>	:DISPlay:EVM:VIEW3:WINDow[1]:TRACe:X[:SCALe]:COUPle 0   1   OFF   ON :DISPlay:EVM:VIEW3:WINDow[1]:TRACe:X[:SCALe]:COUPle?

<b>Example</b>	DISP:EVM:VIEW3:WIND:TRAC:X:COUP OFF DISP:EVM:VIEW3:WIND:TRAC:X:COUP?
Couplings	When this parameter is set to On, pressing the front-panel Restart key activates the scale coupling function, that automatically determines scale per division and reference values based on the measurement results. When you set a value to either Error! Hyperlink reference not valid. or Error! Hyperlink reference not valid. manually, X Auto Scaling automatically changes to Off.
Preset	ON
State Saved	Saved in instrument state.
Range	On Off
Initial S/W Revision	Prior to A.02.00

### AutoScaling (Symbol Power vs. Subcarrier Window)

Toggles the Auto Scaling function between On and Off in the Symbol Power vs. Subcarrier window of the Symbol Power view.

<b>Key Path</b>	SPAN X Scale
<b>Mode</b>	WIMAXOFDMA
<b>Remote Command</b>	:DISPlay:EVM:VIEW4:WINDow[1]:TRACe:X[:SCALE]:COUPle 0   1   OFF   ON :DISPlay:EVM:VIEW4:WINDow[1]:TRACe:X[:SCALE]:COUPle?
<b>Example</b>	DISP:EVM:VIEW4:WIND:TRAC:X:COUP OFF DISP:EVM:VIEW4:WIND:TRAC:X:COUP?
Couplings	When this parameter is set to On, pressing the front-panel Restart key activates the scale coupling function, that automatically determines scale per division and reference values based on the measurement results. When you set a value to either Error! Hyperlink reference not valid. or Error! Hyperlink reference not valid. manually, X Auto Scaling automatically changes to Off.
Preset	ON
State Saved	Saved in instrument state.
Range	On Off
Initial S/W Revision	Prior to A.02.00

### AutoScaling (Absolute Flatness/Differential Flatness Window)

Toggles the Auto Scaling function between On and Off in the Absolute Flatness and Differential Flatness windows of the Spectral Flatness view.

<b>Key Path</b>	SPAN X Scale
<b>Mode</b>	WIMAXOFDMA
<b>Remote Command</b>	:DISPlay:EVM:VIEW6:WINDow[1] 2:TRACe:X[:SCALE]:COUPle 0   1   OFF   ON :DISPlay:EVM:VIEW6:WINDow[1] 2:TRACe:X[:SCALE]:COUPle?



<b>Example</b>	DISP:EVM:VIEW6:WIND:TRAC:X:COUP OFF DISP:EVM:VIEW6:WIND:TRAC:X:COUP?
Couplings	When this parameter is set to On, pressing the front-panel Restart key activates the scale coupling function, that automatically determines scale per division and reference values based on the measurement results. When you set a value to either Error! Hyperlink reference not valid. or Error! Hyperlink reference not valid. manually, X Auto Scaling automatically changes to Off. Values of WIND[1] and WIND2 are ALWAYS coupled with each other.
Preset	ON
State Saved	Saved in instrument state.
Range	On Off
Initial S/W Revision	Prior to A.02.00

### AutoScaling (Power vs Time Window)

Toggles the Auto Scaling function between On and Off in the Power vs. Time window of the Power vs. Time & Spectrum view.

Key Path	SPAN X Scale
Mode	WIMAXOFDMA
<b>Remote Command</b>	:DISPlay:EVM:VIEW7:WINDow[1]:TRACe:X[:SCALe]:COUPle 0   1   OFF   ON :DISPlay:EVM:VIEW7:WINDow[1]:TRACe:X[:SCALe]:COUPle?
<b>Example</b>	DISP:EVM:VIEW7:WIND:TRAC:X:COUP OFF DISP:EVM:VIEW7:WIND:TRAC:X:COUP?
Couplings	When this parameter is set to On, pressing the front-panel Restart key activates the scale coupling function, that automatically determines scale per division and reference values based on the measurement results. When you set a value to either Error! Hyperlink reference not valid. or Error! Hyperlink reference not valid. manually, X Auto Scaling automatically changes to Off.
Preset	ON
State Saved	Saved in instrument state.
Range	On Off
Initial S/W Revision	Prior to A.02.00

### AutoScaling (Symbol Error vs Symbol Window)

Toggles the Auto Scaling function between On and Off in the Symbol Error vs. Symbol window of the Symbol Error view.

Key Path	SPAN X Scale
Mode	WIMAXOFDMA
<b>Remote Command</b>	:DISPlay:EVM:VIEW3:WINDow2:TRACe:X[:SCALe]:COUPle 0 1 OFF ON

	:DISPlay:EVM:VIEW3:WINDow2:TRACe:X[:SCALe]:COUPle?
<b>Example</b>	DISP:EVM:VIEW3:WIND2:TRAC:X:COUP OFF DISP:EVM:VIEW3:WIND2:TRAC:X:COUP?
Couplings	When this parameter is set to On, pressing the front-panel Restart key activates the scale coupling function, that automatically determines scale per division and reference values based on the measurement results. When you set a value to either Error! Hyperlink reference not valid. or Error! Hyperlink reference not valid. manually, X Auto Scaling automatically changes to Off.
Preset	ON
State Saved	Saved in instrument state.
Range	On Off
Initial S/W Revision	Prior to A.02.00

### AutoScaling (Symbol Power vs Symbol Window)

Toggles the Auto Scaling function between On and Off in the Symbol Power vs. Symbol window of the Symbol Power view.

Key Path	SPAN X Scale
Mode	WIMAXOFDMA
<b>Remote Command</b>	:DISPlay:EVM:VIEW4:WINDow2:TRACe:X[:SCALe]:COUPle 0 1 OFF ON :DISPlay:EVM:VIEW4:WINDow2:TRACe:X[:SCALe]:COUPle?
<b>Example</b>	DISP:EVM:VIEW4:WIND2:TRAC:X:COUP OFF DISP:EVM:VIEW4:WIND2:TRAC:X:COUP?
Couplings	When this parameter is set to On, pressing the front-panel Restart key activates the scale coupling function, that automatically determines scale per division and reference values based on the measurement results. When you set a value to either Error! Hyperlink reference not valid. or Error! Hyperlink reference not valid. manually, X Auto Scaling automatically changes to Off.
Preset	ON
State Saved	Saved in instrument state.
Range	On Off
Initial S/W Revision	Prior to A.02.00

## Sweep/Control

Accesses settings that affect the sweep viewed in the display.

Key Path	Sweep/Control
Initial S/W Revision	Prior to A.02.00

## Pause/Resume

Pauses a measurement after the current data acquisition is complete.

When Paused, the label on the key changes to Resume. Pressing Resume un-pauses the measurement.

See Pause/Resume for more information.

Key Path	Sweep/Control
Initial S/W Revision	Prior to A.02.00

## System

See "[System](#)" on page 184

## Trace/Detector

There is no 'Trace/Detector' functionality supported in Modulation Analysis so this front-panel key will display a blank softkey when pressed.

---

Key Path	Trace Detector
Initial S/W Revision	Prior to A.02.00

---

## Trigger

See ["Trigger" on page 244](#)

### Free Run

See ["Free Run " on page 251](#)

### Video

See ["Video \(IF Envelope\) " on page 1160](#)

### Trigger Level

See ["Trigger Level " on page 1161](#)

### Trig Slope

See ["Trig Slope " on page 1162](#)

### Trig Delay

See ["Trig Delay " on page 254](#)

### External 1

See ["External 1 " on page 1175](#)

### Trigger Level

See ["Trigger Level " on page 1175](#)

### Trig Slope

See ["Trig Slope " on page 1176](#)

### Trig Delay

See ["Trig Delay " on page 257](#)

### Zero Span Delay Comp

See ["Zero Span Delay Comp On/Off " on page 1164](#)

### External 2

See ["External 2 " on page 1177](#)

### Trigger Level

See ["Trigger Level " on page 1177](#)

### Trig Slope

See ["Trig Slope " on page 1178](#)

## Trig Delay

See ["Trig Delay "](#) on page 260

## Zero Span Delay Comp

See ["Zero Span Delay Comp On/Off"](#) on page 1166

## RF Burst

See ["RF Burst "](#) on page 1178

## Absolute Trigger

See ["Absolute Trigger Level"](#) on page 1179

## Relative Trigger

See ["Relative Trigger Level"](#) on page 1168

## Trig Slope

See ["Trigger Slope "](#) on page 1180

## Trig Delay

See ["Trig Delay "](#) on page 264

## Periodic Timer

See ["Periodic Timer \(Frame Trigger\) "](#) on page 1170

## Period

See ["Period "](#) on page 1171

## Offset

See ["Offset "](#) on page 1172

## Offset Adjust (Remote Command Only)

See ["Offset Adjust \(Remote Command Only\)"](#) on page 1173

## Reset Offset Display

See ["Reset Offset Display "](#) on page 1174

## Sync Source

See ["Sync Source "](#) on page 1174

## Off

See ["Off "](#) on page 1175

### **External 1**

See ["External 1 "](#) on page 1175

#### **Trigger Level**

See ["Trigger Level "](#) on page 1175

#### **Trig Slope**

See ["Trig Slope "](#) on page 1176

### **External 2**

See ["External 2 "](#) on page 1177

#### **Trigger Level**

See ["Trigger Level "](#) on page 1177

#### **Trig Slope**

See ["Trig Slope "](#) on page 1178

### **RF Burst**

See ["RF Burst "](#) on page 1178

### **Absolute Trigger**

See ["Absolute Trigger Level"](#) on page 1179

#### **Trig Slope**

See ["Trigger Slope "](#) on page 1180

### **Trig Delay**

See ["Trig Delay"](#) on page 275

### **Auto/Holdoff**

See ["Auto/Holdoff "](#) on page 1181

### **Auto Trig**

See ["Auto Trig "](#) on page 1181

### **Trig Holdoff**

See ["Trig Holdoff "](#) on page 1182

### **Internal**

See ["Internal"](#) on page 277



## User Preset

Accesses a menu that gives you the following three choices:

- User Preset – recalls a state previously saved using the Save User Preset function.
- User Preset All Modes – presets all of the modes in the analyzer
- Save User Preset– saves the current state for the current mode

### NOTE

In products that run multiple instances of the X-Series Application, all instances use the same location to save User Preset state. So Save User Preset of one instance will overwrite the Save User Preset of another instance.

Key Path	Front-panel key
Backwards Compatibility Notes	<p>User Preset is actually loading a state, and in legacy analyzers, it was possible to load a state without affecting the trace data, limit lines or correction data. Similarly it was possible to do a User Preset without affecting the trace data, limit lines or correction data.</p> <p>In the X-Series, “state” always includes all of this data; so whenever state is loaded, or User Preset is executed, all of the traces, limit lines and corrections are affected. Although this differs from previous behavior, it is desirable behavior, and should not cause adverse issues for users.</p> <p>On ESA and PSA, User Preset affected the entire instrument’s state. In the X-Series, User Preset only recalls the state for the active mode. There is a User Preset file for each mode. User Preset can never cause a mode switch as it can in legacy analyzers. If you want to recall all modes to their user preset file state, you will need to do a User Preset after mode switching into each mode.</p> <p>User Preset recalls mode state which can now include data like traces; whereas on ESA and PSA, User Preset did not affect data.</p>
Initial S/W Revision	Prior to A.02.00

## User Preset

User Preset sets the state of the currently active mode back to the state that was previously saved for this mode using the Save User Preset menu key or the SCPI command, SYST:PRES:USER:SAV. It not only recalls the Mode Preset settings, but it also recalls all of the mode persistent settings, and the Input/Output system setting that existed at the time Save User Preset was executed.

If a Save User Preset has not been done at any time, User Preset recalls the default user preset file for the currently active mode. The default user preset files are created if, at power-on, a mode detects there is no user preset file. There will never be a scenario when there is no user preset file to restore. For each mode, the default user preset state is the same state that would be saved if a Save User Preset is performed in each mode right after doing a Restore Mode Default and after a Restore Input/Output Defaults.

The User Preset function does the following:

- Aborts the currently running measurement.
- Sets the mode State to the values defined by Save User Preset.
- Makes the saved measurement for the currently running mode the active measurement.
- Brings up the saved menu for the power-on mode.

- Clears the input and output buffers.
- Sets the Status Byte to 0.

Key Path	User Preset
Remote Command	:SYSTem:PRESet:USER
Example	:SYST:PRES:USER:SAVE:SYST:PRES:USER
Notes	:SYST:PRES:USER:SAVE is used to save the current state as the user preset state. Clears all pending OPC bits. The Status Byte is set to 0. Pressing the User Preset front-panel key while already in the User Preset menu will cause the User Preset to get executed
Couplings	A user preset will cause the currently running measurement to be aborted and cause the saved measurement to be active. Recalling a User Preset file has the same issues that recalling a Save State file has. Some settings may need to be limited and therefore re-coupled, since the capabilities of the mode may have changes when the User Preset file was last saved.
Initial S/W Revision	Prior to A.02.00

## User Preset All Modes

Recalls all of the User Preset files for each mode, switches to the power-on mode, and activates the saved measurement from the power-on mode User Preset file.

**NOTE**

When the instrument is secured, all of the user preset files are converted back to their default user preset files.

The User Preset function does the following:

- Aborts the currently running measurement.
- Switches the Mode to the power-on mode.
- Restores the User Preset files for each mode.
- Makes the saved measurement for the power-on mode the active measurement.
- Brings up the saved menu for the power-on mode.
- Clears the input and output buffers.
- Sets the Status Byte to 0.

Key Path	User Preset
Remote Command	:SYSTem:PRESet:USER:ALL
Example	:SYST:PRES:USER:SAVE:SYST:PRES:USER:ALL
Notes	Clears all pending OPC bits. The Status Byte is set to 0. :SYST:PRES:USER:SAVE is used to save the current state as the user preset state.
Couplings	A user preset will cause the currently running measurement to be aborted, cause a mode switch to the power-on mode, and cause the saved measurement to be active in the power-on mode.

---

Recalling a User Preset file has the same issues that recalling a Save State file has. Some settings may need to be limited and therefore re-coupled, since the capabilities of the mode may have changes when the User Preset file was last saved.

---

Initial S/W Revision      Prior to A.02.00

---

## Save User Preset

Saves the currently active mode and its State. You can recall this User Preset file by pressing the User Preset menu key or sending the SYST:PRES:USER remote command. This same state is also saved by the Save State function.

Key Path	User Preset
<b>Remote Command</b>	:SYSTem:PRESet:USER:SAVE
<b>Example</b>	:SYST:PRES:USER:SAVE
Notes	:SYST:PRES:SAVE creates the same file as if the user requested a *SAV or a MMEM: STOR:STAT, except User Preset Save does not allow the user to specify the filename or the location of the file.
Initial S/W Revision	Prior to A.02.00

## View/Display

Accesses a menu that enables you to select from the following measurement view and display settings, shown below.

This topic contains the following sections:

["Understanding Front Panel Results to Use Remote Commands" on page 1504](#)

["Front Panel Results" on page 1504](#)

["View Selection by name \(SCPI Only\)" on page 1505](#)

["View Selection by number \(SCPI Only\)" on page 1505](#)

NOTE: the view setting options depend on the measurement view that is active.

### Understanding Front Panel Results to Use Remote Commands

WiMAX Modulation Analysis measurement has 7 views. They can be selected both by the front-panel and remotely (SCPI commands). View # and Window # in the table below are also used as subsets of :DISPlay subsets, for example:

:DISPlay:EVM:VIEW4:WINDow2:TRACe:X:SCALE:PDIVision?

Denotes X Scale/Div value query of Symbol Power vs Symbol trace (View # = 4, Window # = 2).

### Front Panel Results

View #	View	Number of Windows	Window #	Window
[1]	I/Q Symbol Constellation	2	[1]	Results Summary
			2	I/Q Symbol Constellation
2	Zone & Data Burst Info	3	[1]	Zone List
			2	Zone Definition
			3	Data Burst List
3	Symbol Error (Quad View)	4	[1]	Symbol Error vs Subcarriers
			2	Symbol Error vs Symbol
			3	I/Q Symbol Constellation
			4	Zone Definition
4	Symbol Power (Quad View)	4	[1]	Symbol Power vs Subcarriers
			2	Symbol Power vs Symbol
			3	I/Q Symbol Constellation
			4	Zone Definition
5	Peak/Average Metrics	1	[1]	Result Summary

6	Spectral Flatness	3	[1]	Absolute Flatness
			2	Differential Flatness
			3	Result Summary
7	Power vs Time & Spectrum	2	[1]	Power vs Time

### View Selection by name (SCPI Only)

The following remote command enables you to select the desired measurement view by Enum .

Key Path	View/Display
Mode	WIMAXOFDMA
<b>Remote Command</b>	:DISPlay:EVM:VIEW[:SELEct] POLar   ZMAP   SERRor   SPOWer   SUMMary   FLATness   PVT  :DISPlay:EVM:VIEW[:SELEct]?
<b>Example</b>	DISP:EVM:VIEW:SEL PVT DISP:EVM:VIEW:SEL?
Couplings	:DISP:EVM:VIEW[:SEL] and :DISP:EVM:VIEW:NSEL shall be synchronized with each other.
Preset	POLar
State Saved	Saved in instrument state.
Range	I/Q Measured Polar Constln Zone/Data Burst Info Symbol Error (Quad View) Symbol Power(Quad View) Peak/Average Metrics Spectrum Flatness Power vs Time & Spectrum
Initial S/W Revision	Prior to A.02.00

### View Selection by number (SCPI Only)

The following remote command enables you to select the desired measurement view by number.

Mode	WIMAXOFDMA
<b>Remote Command</b>	:DISPlay:EVM:VIEW:NSELEct <integer>  :DISPlay:EVM:VIEW:NSELEct?
<b>Example</b>	DISP:EVM:VIEW:NSEL 1 DISP:EVM:VIEW:NSEL?
Couplings	:DISP:EVM:VIEW[:SEL] and :DISP:EVM:VIEW:NSEL shall be synchronized with each other.
Preset	1
State Saved	Saved in instrument state.
Min	1
Max	7
Initial S/W Revision	Prior to A.02.00

---

Key Path	Front-Panel
Initial S/W Revision	Prior to A.02.00

---

## Display

The Display menu is common to most measurements, and is used for configuring items on the display. Some Display menu settings apply to all the measurements in a mode, and some only to the current measurement. Those under the System Display Settings key apply to all measurements in all modes.

---

Key Path	Display
Key Path	View/Display
Initial S/W Revision	Prior to A.02.00

---

## Annotation

Turns on and off various parts of the display annotation. The annotation is divided up into four categories:

1. Meas Bar: This is the measurement bar at the top of the screen. It does not include the settings panel or the Active Function. Turning off the Meas Bar turns off the settings panel and the Active Function. When the Meas Bar is off, the graticule area expands to fill the area formerly occupied by the Meas Bar.
2. Screen Annotation: this is the annotation and annunciation around the graticule, including any annotation on lines (such as the display line, the threshold line, etc.) This does NOT include the marker number or the N dB result. When off, the graticule expands to fill the entire graticule area.
3. Trace annotation: these are the labels on the traces, showing their detector (or their math mode).
4. Active Function annotation: this is the active function display in the meas bar, and all of the active function values displayed on softkeys.

See the figure below. Each type of annotation can be turned on and off individually.

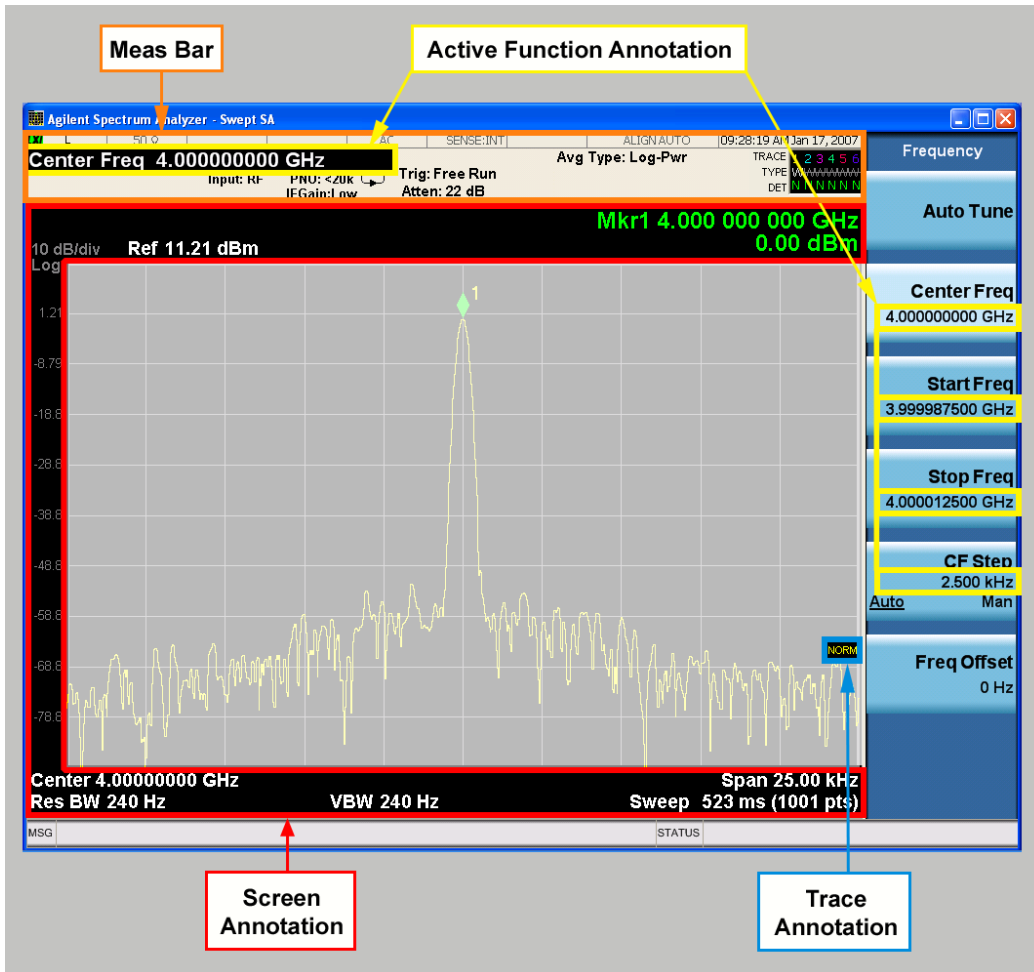

Key Path	View/Display, Display
Initial S/W Revision	Prior to A.02.00

### Meas Bar On/Off

This function turns the Measurement Bar on and off, including the settings panel. When off, the graticule area expands to fill the area formerly occupied by the Measurement Bar.

Key Path	View/Display, Display, Annotation
Remote Command	:DISPlay:ANNotation:MBAR[:STATE] OFF ON 0 1 :DISPlay:ANNotation:MBAR[:STATE]?
Example	DISP:ANN:MBAR OFF
Dependencies	Grayed out and forced to OFF when System Display Settings, Annotation is set to Off.
Preset	On This should remain Off through a Preset when System DisplaySettings, Annotation is set to Off.

State Saved	Saved in instrument state.
Initial S/W Revision	Prior to A.02.00

## Screen

This controls the display of the annunciation and annotation around the graticule, including any annotation on lines (such as the display line, the threshold line, etc.) and the y-axis annotation. This does NOT include marker annotation (or the N dB result). When off, the graticule expands to fill the entire graticule area, leaving only the 1.5% gap above the graticule as described in the Trace/Detector chapter.

Key Path	View/Display, Display, Annotation
Remote Command	:DISPlay:ANNotation:SCReen[:STATe] OFF ON 0 1 :DISPlay:ANNotation:SCReen[:STATe]?
Example	DISP:ANN:SCR OFF
Dependencies	Grayed-out and forced to OFF when System Display Settings, Annotation is set to Off.
Preset	On This should remain Off through a Preset when System DisplaySettings, Annotation is set to Off
State Saved	Saved in instrument state.
Initial S/W Revision	Prior to A.02.00

## Active Function Values On/Off

Turns on and off the active function display in the Meas Bar, and all of the active function values displayed on the softkeys.

Note that all of the softkeys that have active functions have these numeric values blanked when this function is on. This is a security feature..



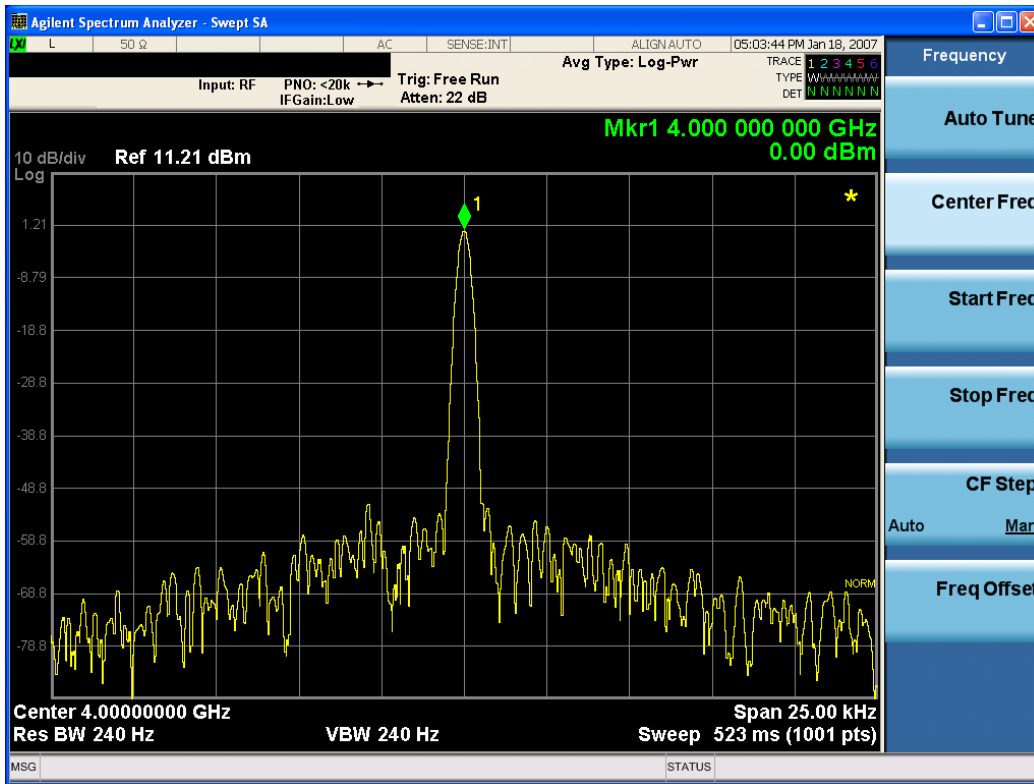

Key Path	View/Display, Display, Annotation
Remote Command	:DISPlay:ACTivefunc[:STATE] ON OFF 1 0 :DISPlay:ACTivefunc[:STATE]?
Example	DISP:ACT OFF
Dependencies	Grayed out and forced to OFF when System Display Settings, Annotation is set to Off.
Preset	On This should remain Off through a Preset when System DisplaySettings, Annotation is set to Off
State Saved	Saved in instrument state.
Initial S/W Revision	Prior to A.02.00

### Title

Displays menu keys that enable you to change or clear a title on your display.

Key Path	View/Display, Display
Initial S/W Revision	Prior to A.02.00

### Change Title

Writes a title into the "measurement name" field in the banner, for example, "Swept SA".

Press Change Title to enter a new title through the alpha editor. Press Enter or Return to complete the entry. Press ESC to cancel the entry and preserve your existing title.

The display title will replace the measurement name. It remains for this measurement until you press Change Title again, or you recall a state, or a Preset is performed. A title can also be cleared by pressing Title, Clear Title.

**NOTE**

Notice the inclusion of the <measurement> parameter in the command below. Because each measurement remembers the Display Title, the command must be qualified with the measurement name. For the Swept SA measurement this is not the case; no <measurement> parameter is used when changing the Display Title for the Swept SA measurement.

Key Path	View/Display, Display, Title
Mode	All
Remote Command	:DISPlay:<measurement>:ANNotation:TITLe:DATA <string> :DISPlay:<measurement>:ANNotation:TITLe:DATA?
Example	DISP:ANN:TITL:DATA "This Is My Title" This example is for the Swept SA measurement in the Spectrum Analyzer mode. The SANalyzer <measurement> name is not used. DISP:ACP:ANN:TITL:DATA "This Is My Title" This example is for Measurements other than Swept SA. Both set the title to: This Is My Title
Notes	Pressing this key cancels any active function. When a title is edited the previous title remains intact (it is not cleared) and the cursor goes at the end so that characters can be added or BKSP can be used to go back over previous characters.
Preset	No title (measurement name instead)
State Saved	Saved in instrument state.
Initial S/W Revision	Prior to A.02.00

**Clear Title**

Clears a title from the front-panel display. Once cleared, the title cannot be retrieved. After the title is cleared, the current Measurement Name replaces it in the title bar.

Key Path	View/Display, Display, Title
Example	The following commands clear the title and restore the measurement's original title: DISP:ANN:TITL:DATA "" This example is for the Swept SA measurement in the Spectrum Analyzer mode. The SANalyzer <measurement> name is not used. DISP:ACP:ANN:TITL:DATA "" This example is for ACP; in measurements other than Swept SA the measurement name is required.
Notes	Uses the :DISPlay:<measurement>:ANNotation:TITLe:DATA <string> command with an empty string (in the Swept SA, the <measurement> is omitted).

Preset	Performed on Preset.
Initial S/W Revision	Prior to A.02.00

## Graticule

Pressing Graticule turns the display graticule On or Off. It also turns the graticule y-axis annotation on and off.

Key Path	View/Display, Display
<b>Remote Command</b>	:DISPlay:WINDow[1]:TRACe:GRATicule:GRID[:STATe] OFF ON 0 1 :DISPlay:WINDow[1]:TRACe:GRATicule:GRID[:STATe]?
<b>Example</b>	DISP:WIND:TRAC:GRAT:GRID OFF
Notes	The graticule is the set of horizontal and vertical lines that make up the grid/divisions for the x-axis and y-axis.
Preset	On
State Saved	Saved in instrument state
Initial S/W Revision	Prior to A.02.00

## System Display Settings

These settings are "Mode Global" – they affect all modes and measurements and are reset only by Restore Misc Defaults or Restore System Defaults under System.

Key Path	View/Display, Display
Initial S/W Revision	Prior to A.02.00

## Annotation Local Settings

This is a Mode Global override of the meas local annotation settings. When it is All Off, it forces ScreenAnnotation, Meas Bar, Trace, and Active Function Values settings to be OFF for all measurements in all modes. This provides the security based "annotation off" function of previous analyzers; hence it uses the legacy SCPI command.

When it is All Off, the Screen, Meas Bar, Trace, and Active Function Values keys under the Display, Annotation menu are grayed out and forced to Off. When Local Settings is selected, you are able to set the local annotation settings on a measurement by measurement basis.

Key Path	View/Display, Display, System Display Settings
<b>Remote Command</b>	:DISPlay:WINDow[1]:ANNOtation[:ALL] OFF ON 0 1 :DISPlay:WINDow[1]:ANNOtation[:ALL]?
<b>Example</b>	:DISP:WIND:ANN OFF

Preset	On (Set by Restore Misc Defaults)
State Saved	Not saved in instrument state.
Backwards Compatibility Notes	The WINDow parameter and optional subopcode is included for backwards compatibility but ignored – all windows are equally affected.
Initial S/W Revision	Prior to A.02.00

## Themes

Accesses a menu of functions that enable you to choose the theme to be used when saving the screen image.

The **Themes** option is the same as the **Themes** option under the **Display** and **Page Setup** dialogs. It allows you to choose between themes to be used when saving the screen image.

Key Path	Save, Screen Image
<b>Remote Command</b>	:MMEMory:STORe:SCReen:THEMe TDColor   TDMonochrome   FCOLor   FMONochrome  :MMEMory:STORe:SCReen:THEMe?
<b>Example</b>	:MMEM:STOR:SCR:THEM TDM
Preset	3D Color; Is not part of Preset, but is reset by Restore Misc Defaults or Restore System Defaults All and survives subsequent running of the modes.
Readback	3D Color   3D Mono   Flat Color   Flat Mono
Backwards Compatibility Notes	In ESA and PSA we offer the choice of "Reverse Bitmap" or "Reverse Metafile" when saving screen images. This is much like the "Flat Color" theme available in X-Series. Also, if you selected Reverse Bitmap AND a black & white screen image, that would be much like "Flat Monochrome". In other words, each of the X-Series themes has a similar screen image type in ESA/PSA. But they are not identical.
Initial S/W Revision	Prior to A.02.00

## 3D Color

Selects a standard color theme with each object filled, shaded and colored as designed.

Key Path	Save, Screen Image, Themes
<b>Example</b>	MMEM:STOR:SCR:THEM TDC
Readback	3D Color
Initial S/W Revision	Prior to A.02.00

## 3D Monochrome

Selects a format that is like 3D color but shades of gray are used instead of colors.

Key Path	Save, Screen Image, Themes
<b>Example</b>	MMEM:STOR:SCR:THEM TDM
Readback	3D Mono
Initial S/W Revision	Prior to A.02.00

#### Flat Color

Selects a format that is best when the screen is to be printed on an ink printer.

Key Path	Save, Screen Image, Themes
<b>Example</b>	MMEM:STOR:SCR:THEM FCOL
Readback	Flat Color
Initial S/W Revision	Prior to A.02.00

#### Flat Monochrome

Selects a format that is like Flat Color. But only black is used (no colors, not even gray), and no fill.

Key Path	Save, Screen Image, Themes
<b>Example</b>	MMEM:STOR:SCR:THEM FMON
Readback	Flat Mono
Initial S/W Revision	Prior to A.02.00

#### IQ Symbol Measured Constin

The following figure shows I/Q Symbol Constellation view image. The window 1 (left window) shows metrics summary and the window 2 (right) shows I/Q Symbol constellation. The I/Q Symbol constellation is updated by each zone.

The view consists of the following windows:

"I/Q Symbol Constellation Window" on page 1514

"Numeric Results Window" on page 1514

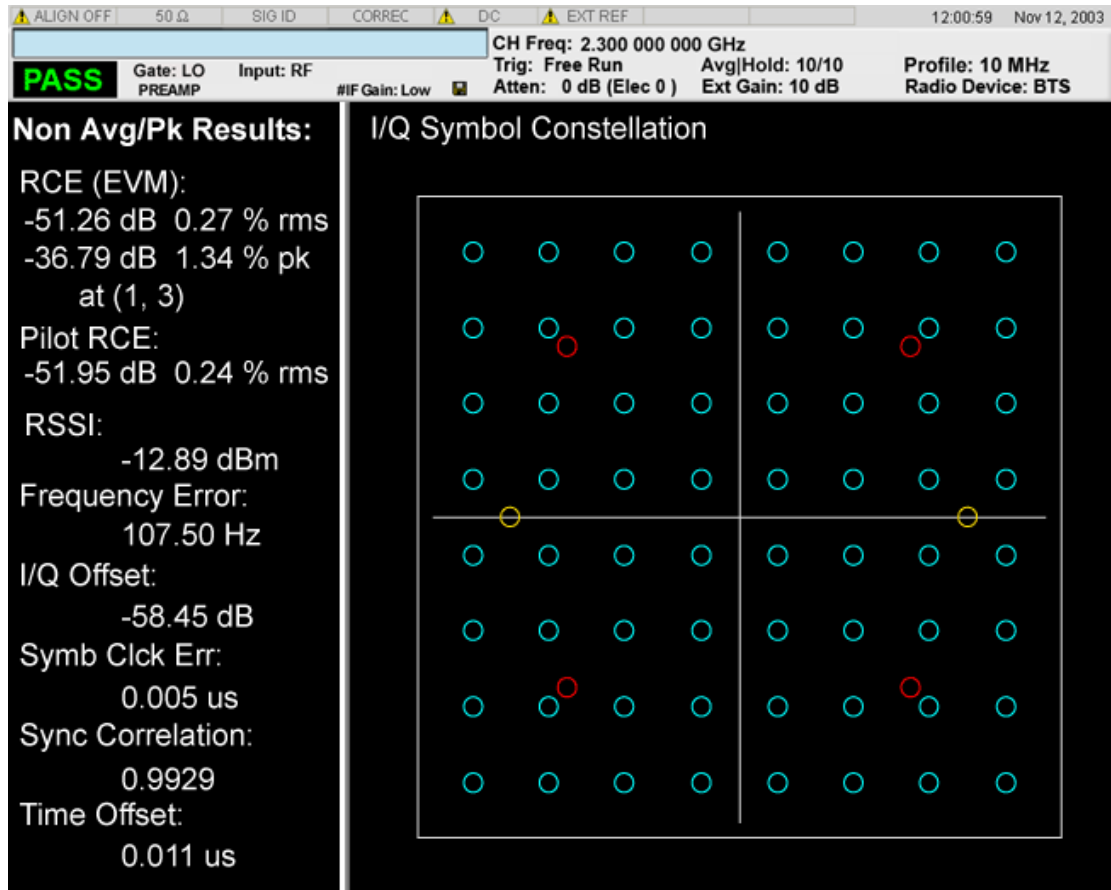

### I/Q Symbol Constellation Window

Marker Operation	Yes {{Symbol, Subcarrier}} - {X,Y}
Corresponding Trace	Corrected measured trace (n=8) The color of symbols is aligned to data burst definition of Zone Definition. White is reserved for pilot subcarrier. This trace is affected by I/Q Meas Polar view setting parameters.

### Numeric Results Window

Name	Corresponding Results	Display Format
RMS RCE (EVM)	n=1-1, Total RMS RCE (EVM) in dB n=1-0, Total RMS RCE (EVM) in %	XX.XX dB XX.XX % rms
Peak RCE (EVM)	n=1-0, Total Peak RMS RCE (EVM) in dB n=1-0, Total Peak RMS RCE (EVM) in %	XX.XX dB XX.XX % pk
Peak RCE Location	n=1-0, Peak RCE (EVM) Symbol Number n=1-0, Peak RCE (EVM) Subcarrier Number	at (XX, XX)

RMS Pilot RCE	n=1-17, Pilot RCE in dB n=1-17, Pilot RCE in %	XX.XX dB XX.XX %
RSSI	n=1-0, RSSI	XX.XX dBm
Freq Err	n=1-0, Frequency Error	XX.XX Hz
I/Q Offset	n=1-0, I/Q Offset	XX.XX dB
Symbol Clk Error	n=1-17, Symb Clk Err	XX.XX s
Sync Correlation	n=1-0, Sync Correlation	
Time Offset	n=1-0, Time Offset	XX.XX s

Key Path	View/Display
Initial S/W Revision	Prior to A.02.00

### Inactive Subchannels

Include or excludes the inactive subchannels in the EVM traces (this only applies to Data Burst Analysis mode). This parameter does not affect the EVM calculation. If this parameter is set to "Include", the EVM results will include the EVM value of the Unmodulated subchannels, and I/Q Meas will include the Unmodulated subcarriers' constellation.

Key Path	View/Display, I/Q Measured Polar Constln
Mode	WIMAXOFDMA
<b>Remote Command</b>	:DISPlay:EVM:SUBChannel:INActive INCLude EXCLude :DISPlay:EVM:SUBChannel:INActive?
<b>Example</b>	DISP:EVM:SUBC:INAC INCL DISP:EVM:SUBC:INAC?
Preset	EXCLude
State Saved	Saved in instrument state.
Range	INCLude EXCLude
Initial S/W Revision	Prior to A.02.00

### Zone Data Burst Info

Provides a combination view of a Zone list table, the selected map graph, and the Data Burst list table.

Zone & Burst Data Info view consists of 3 windows.

"Zone List Window" on page 1516

"Zone Definition Window" on page 1516

"Data Burst List Window" on page 1517

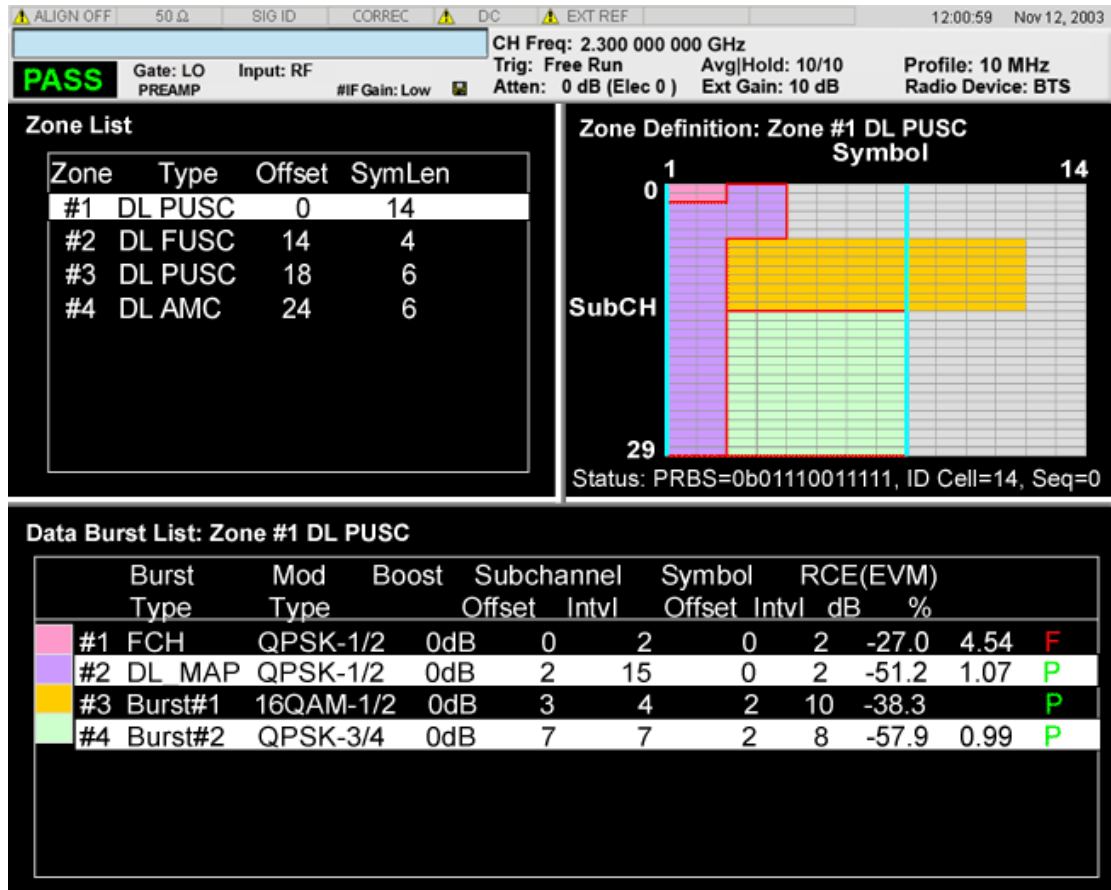

### Zone List Window

Name	Corresponding Results	Display Format
Zone Name	None, exported into *.omf file.	String
Zone Type	None, exported into *.omf file.	String
Symbol Offset	None, exported into *.omf file.	XX
Symbol Length	None, exported into *.omf file.	XX

### Zone Definition Window

Marker Operation	No
Corresponding Trace	None. Data Burst Info is returned by n=13 with a Data Burst Number (:CALCulate:EVM:INformation:BURSt

Name	Corresponding Results	Display Format
Status	n=1-43, PRBS n=1-44, IDCell	0bXXXXXXXXXX XX X



n=1-45, Segment

### Data Burst List Window

Name	Corresponding Results	Display Format
Burst Name	None	String
Burst Type	None, but the value of specified burst is returned in n=13-1.	String
Mod Type	None, but the value of specified burst is returned in n=13-2.	String (Enum)
Boost Level	None, but the value of specified burst is returned in n=13-3.	XX.XX dB
Subchannel Offset	None, but the value of specified burst is returned in n=13-4.	XX
Subchannel Interval	None, but the value of specified burst is returned in n=13-5.	XX
Symbol Offset	None, but the value of specified burst is returned in n=13-6.	XX
Symbol Interval	None, but the value of specified burst is returned in n=13-7.	XX
RCE (EVM) in dB	None, but the value of specified burst is returned in n=13-9.	XX.XX dB
RCE (EVM) in %	None, but the value of specified burst is returned in n=13-10.	XX.XX dB

Key Path	View/Display
Initial S/W Revision	Prior to A.02.00

### Symbol Error (Quad View)

The Symbol Error (Quad View) view consists of 4 windows. Both the Symbol Error vs Subcarrier and the Symbol Error vs Symbol use the same trace by 2-D shuffling. I/Q Symbol Constellation window shows the same trace as one in the Symbol Power view. Zone Definition window shows graphic which depicts the current zone definition.

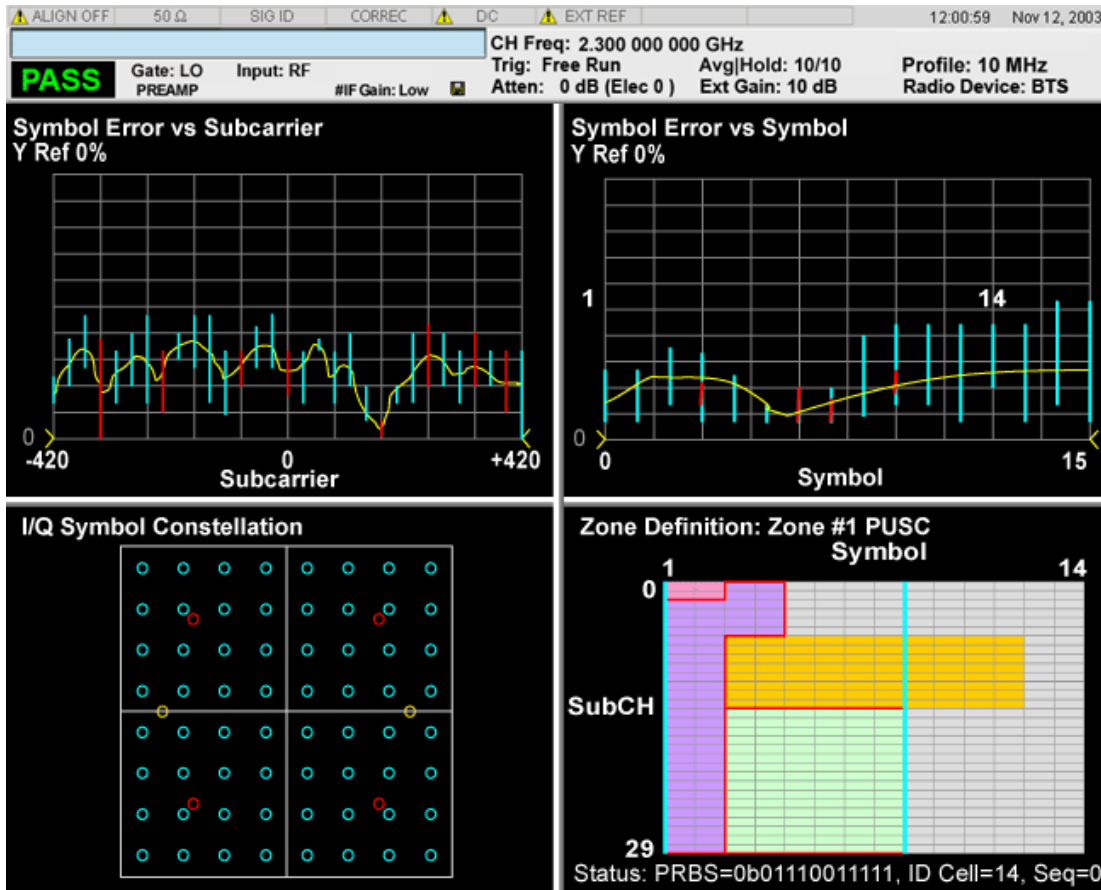

"Symbol Error vs Subcarrier Window" on page 1518

"Symbol Error vs Symbol Window" on page 1518

"I/Q Symbol Constellation Window" on page 1518

"Zone Definition Window" on page 1519

### Symbol Error vs Subcarrier Window

Corresponding Trace	n=2 Symbol Error Trace	Light blue bar, colored dot
	n=3 RMS Symbol Error vs Subcarrier	Yellow

### Symbol Error vs Symbol Window

Corresponding Trace	n=2 Symbol Error Trace	Light blue bar, colored dot
	n=4 RMS Symbol Error vs Symbol	Yellow

### I/Q Symbol Constellation Window

The same as I/Q Symbol Constellation Window in "I/Q Symbol Measured Constin" on page 1513.

Marker Operation	Yes ({Symbol, Subcarrier} – {X,Y})
Corresponding Trace	Corrected measured trace (n=8) The color of symbols is aligned to data burst definition of Zone Definition. White is reserved for pilot subcarrier.

### Zone Definition Window

Marker Operation	No
Corresponding Trace	None. Data Burst Info is returned by n=17 with a Data Burst Number :(CALCulate:EVM:INformation:BURSt)

Name	Corresponding Results	Display Format
Status	n=1–43, PRBS n=1–44, IDCell n=1–45, Segment	0bXXXXXXXXXX XX X

Key Path	View/Display
Initial S/W Revision	Prior to A.02.00

### Inactive Subchannels

Include or excludes the inactive subchannels in the EVM traces (this only applies to Data Burst Analysis mode). This parameter does not affect the EVM calculation. If this parameter is set to “Include”, the EVM results will include the EVM value of the Unmodulated subchannels, and I/Q Meas will include the Unmodulated subcarriers’ constellation.

Key Path	View/Display, I/Q Measured Polar Constln
Mode	WIMAXOFDMA
<b>Remote Command</b>	:DISPlay:EVM:SUBChannel:INActive INCLude EXCLude :DISPlay:EVM:SUBChannel:INActive?
<b>Example</b>	DISP:EVM:SUBC:INAC INCL DISP:EVM:SUBC:INAC?
Preset	EXCLude
State Saved	Saved in instrument state.
Range	INCLude EXCLude
Initial S/W Revision	Prior to A.02.00

### Symbol Power (Quad View)

The Symbol Power (Quad View) view consists of 4 windows. Both the Symbol Power vs Subcarrier and the Symbol Power vs Symbol use the same trace by 2-D shuffling. I/Q Symbol Constellation window shows the same trace as one in the Symbol Error view. Zone Definition window shows graphic which depicts the current zone definition.

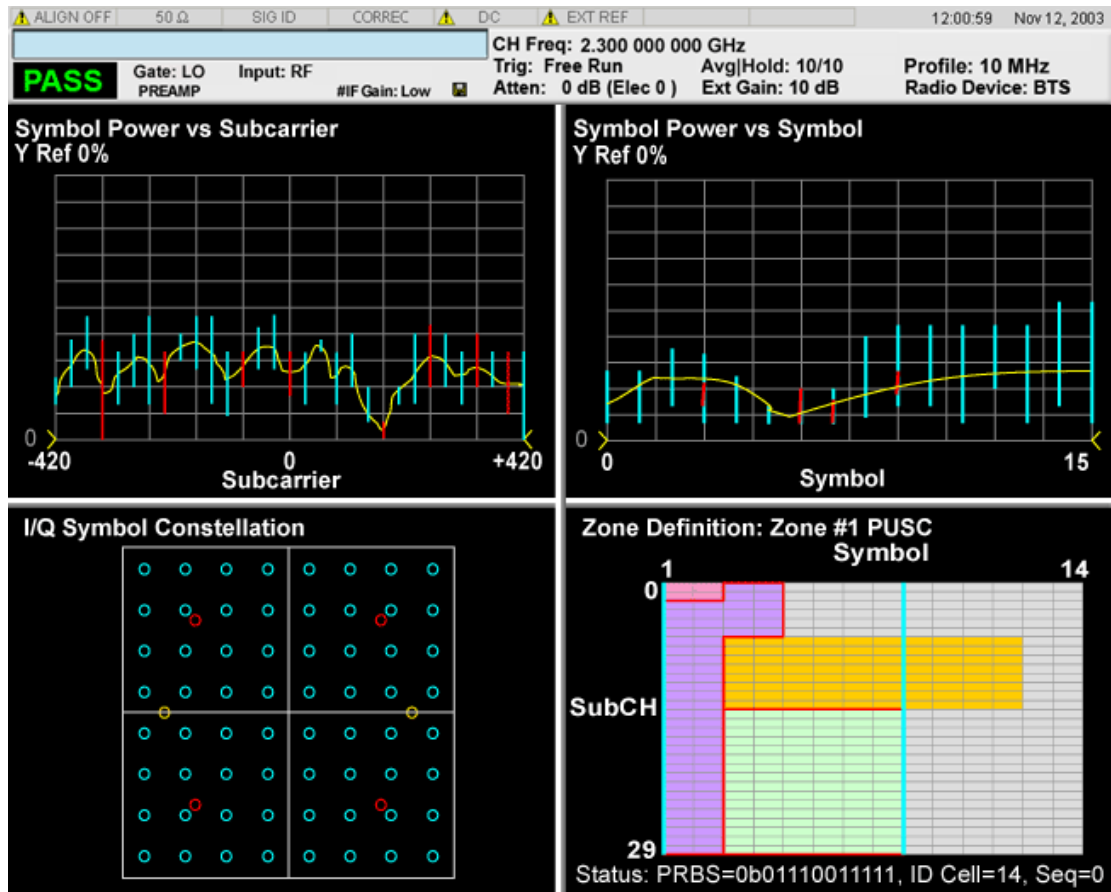

"Symbol Power Vector vs Subcarrier Window" on page 1520

"Symbol Power Vector vs Symbol" on page 1521

"I/Q Symbol Constellation" on page 1521

"Zone Definition" on page 1521

### Symbol Power Vector vs Subcarrier Window

Corresponding Trace	n=5 Symbol Power Trace	Light blue bar, colored dot
	n=6 RMS Symbol Power vs Subcarrier	Yellow

## Symbol Power Vector vs Symbol

Corresponding Trace	n=5 Symbol Power Trace	Light blue bar, colored dot
	n=7 RMS Symbol Power vs Symbol	Yellow

## I/Q Symbol Constellation

The same as I/Q Symbol Constellation Window in "I/Q Symbol Measured Constn" on page 1513.

Marker Operation	Yes {{Symbol, Subcarrier} - {X,Y}}
Corresponding Trace	Corrected measured trace (n=8) The color of symbols is aligned to data burst definition of Zone Definition. White is reserved for pilot subcarrier.

## Zone Definition

Marker Operation	No
Corresponding Trace	None. Data Burst Info is returned by n=17 with a Data Burst Number (:CALCulate:EVM:INFormation:BURSt)

Name	Corresponding Results	Display Format
Status	n=1-43, PRBS n=1-44, IDCell n=1-45, Segment	0bXXXXXXXXXX XX X

Key Path	View/Display
Initial S/W Revision	Prior to A.02.00

## Inactive Subchannels

Include or excludes the inactive subchannels in the EVM traces (this only applies to Data Burst Analysis mode). This parameter does not affect the EVM calculation. If this parameter is set to "Include", the EVM results will include the EVM value of the Unmodulated subchannels, and I/Q Meas will include the Unmodulated subcarriers' constellation.

Key Path	View/Display, I/Q Measured Polar Constn
Mode	WIMAXOFDMA
<b>Remote Command</b>	:DISPlay:EVM:SUBChannel:INActive INCLude EXCLude :DISPlay:EVM:SUBChannel:INActive?

<b>Example</b>	DISP:EVM:SUBC:INAC INCL DISP:EVM:SUBC:INAC?
Preset	EXCLude
State Saved	Saved in instrument state.
Range	INCLude EXCLude
Initial S/W Revision	Prior to A.02.00

### Peak/Avg Metrics

Provides a table of the summary for the measurement result and information at the selected burst.

	Average		Peak Hold		Std Dev
RMS RCE (EVM):	-51.26 dB	0.27 % P	-49.33 dB	0.31 %	
Peak RCE (EVM): (Pilot Included)	-36.79 dB	1.34 % P	-34.77 dB	1.56 %	
RCE - Pilot:	-51.95 dB	0.24 % P	-51.95 dB	0.25 %	
RCE - Unmod:	-65.33 dB	0.08 %	-64.11 dB	0.09 %	
RCE - Preamble:	-48.22 dB	0.39 %	-48.22 dB	0.39 %	
Freq Error:	103.34 Hz		105.68 Hz	P	
Preamble Pwr (RSSI):	12.80 dBm		12.80 dBm		-52.55 dBm
Preamble PCINR R1:	41.397 dB		41.397 dB		16.741 dB
R3:	41.251 dB		41.251 dB		20.879 dB
FFT Total Power:	-20.11 dBm		-20.11 dBm		
Symbol Clock Err:	-0.112 ppm		-0.112 ppm		
Sync Correlation:	0.9948		0.9948		
Time Offset:	100.39 usec	P	100.39 usec		
I/Q (DC) Offset:	-50.99 dB	P	-50.99 dB		
Abs Flatness (Max):	-3.14 dBm	0.97 dBc	@Subcarrier : 15	P	
(Min):	-5.25 dBm	-1.14 dBc	@Subcarrier : -209	F	
Diff Flatness (Max):		0.04 dB	@Subcarrier : -122	F	
(Min):		-0.40 dB	@Subcarrier : -404	F	

Name	Corresponding Results	Display Format
Averaged Total RMS RCE (EVM)	n=1-0, Total RMS RCE (EVM) in dB n=1-0, Total RMS RCE (EVM) in %	XX.XX dB XX.XX %
Max Total RMS RCE (EVM)	n=1-0, Total RMS RCE (EVM) in dB n=1-0, Total RMS RCE (EVM) in %	XX.XX dB XX.XX %
SD of Total RMS RCE	n=1-0, Total RMS RCE (EVM) in dB	XX.XX dB XX.XX %

(EVM)	n=1-0, Total RMS RCE (EVM) in %	
Averaged Peak RCE (EVM)	n=1-0, Peak RMS RCE (EVM) in dB n=1-0, Peak RMS RCE (EVM) in %	XX.XX dB XX.XX %
Max Peak RCE (EVM)	n=1-0, Peak RMS RCE (EVM) in dB n=1-0, Peak RMS RCE (EVM) in %	XX.XX dB XX.XX %
Max Peak RCE symbol & subcarrier	n=1-0, Peak RCE (EVM) Subcarrier index n=1-0, Peak RCE (EVM) Symbol Number	at Subcarrier XXX Symbol XX
SD of Peak RCE (EVM)	n=1-0, Peak RMS RCE (EVM) in dB n=1-0, Peak RMS RCE (EVM) in %	XX.XX dB XX.XX %
Averaged Pilot RMS RCE (EVM)	n=1-0, Pilot RMS RCE (EVM) in dB n=1-0, Pilot RMS RCE (EVM) in %	XX.XX dB XX.XX %
Max Pilot RMS RCE (EVM)	n=1-0, Pilot RMS RCE (EVM) in dB n=1-0, Pilot RMS RCE (EVM) in %	XX.XX dB XX.XX %
SD of Pilot RMS RCE (EVM)	n=1-0, Pilot RMS RCE (EVM) in dB n=1-0, Pilot RMS RCE (EVM) in %	XX.XX dB XX.XX %
Averaged Unmod RMS RCE (EVM)	n=1-0, Unmod RMS RCE (EVM) in dB n=1-0, Unmod RMS RCE (EVM) in %	XX.XX dB XX.XX %
Max Unmod RMS RCE (EVM)	n=1-0, Unmod RMS RCE (EVM) in dB n=1-0, Unmod RMS RCE (EVM) in %	XX.XX dB XX.XX %
SD of Unmod RMS RCE (EVM)	n=1-0, Unmod RMS RCE (EVM) in dB n=1-0, Unmod RMS RCE (EVM) in %	XX.XX dB XX.XX %
Freq Err	n=1-0, Averaged Frequency Error in Hz n=1-0, Max Frequency Error in Hz n=1-0, SD of Frequency Error in Hz	XX.XX Hz XX.XX Hz
I/Q Offset	n=1-0, Averaged I/Q Origin Offset in dB n=1-0, Max I/Q Origin Offset in dB n=1-0, SD of I/Q Origin Offset in dB	XX.XX dB XX.XX dB
Symbol Clk Err	n=1-0, Averaged Symbol Clock Error in ppm n=1-0, Max Symbol Clock Error in ppm n=1-0, Averaged Symbol Clock Error in ppm	XX.XXX ppm XX.XXX ppm
Sync Corr (UL Only)	n=1-0, Averaged Sync Correlation n=1-0, Max Sync Correlation n=1-0, SD of Sync Correlation	X.XXXX X.XXXX
Time Offset	n=1-0, Averaged Time Offset in sec n=1-0, Max Time Offset in sec n=1-0, SD of Time Offset in sec	XX.XXX sec XX.XXX sec
RSSI	n=1-0, Averaged RSSI in dBm n=1-0, Max RSSI in dBm n=1-0, Averaged RSSI in dBm	XX.XX dBm XX.XX dBm

Total Power (FFT)	n=1-0, Averaged Total Power n=1-0, Max Total Power n=1-0, SD of Total Power	XX.XX dBm XX.XX dBm
Abs Max Subcarrier Power	n=1-48, Max Power in dBm n=1-49, Max Power in dBc n=1-51, Max Subcarrier Index	XX.XX dBm XX.XX dBc XXX
Abs Min Subcarrier Power	n=1-52, Min Power in dBm n=1-53, Min Power in dBc n=1-55, Min Subcarrier Index	XX.XX dBm XX.XX dBc XXX
Differential Max Subcarrier Power	n=1-56, Max Power in dB n=1-58, Max Subcarrier Index	XX.XX dB XXX
Differential Min Subcarrier Power	n=1-59, Min Power in dB n=1-61, Min Subcarrier Index	XX.XX dB XXX

Key Path	View/Display
Initial S/W Revision	Prior to A.02.00

### Zoomed Result Metrics

When Result Metrics Window is focused and the user zooms the window, spectral flatness result for each offset is shown. These results are identical to n=21 of SCPI results.



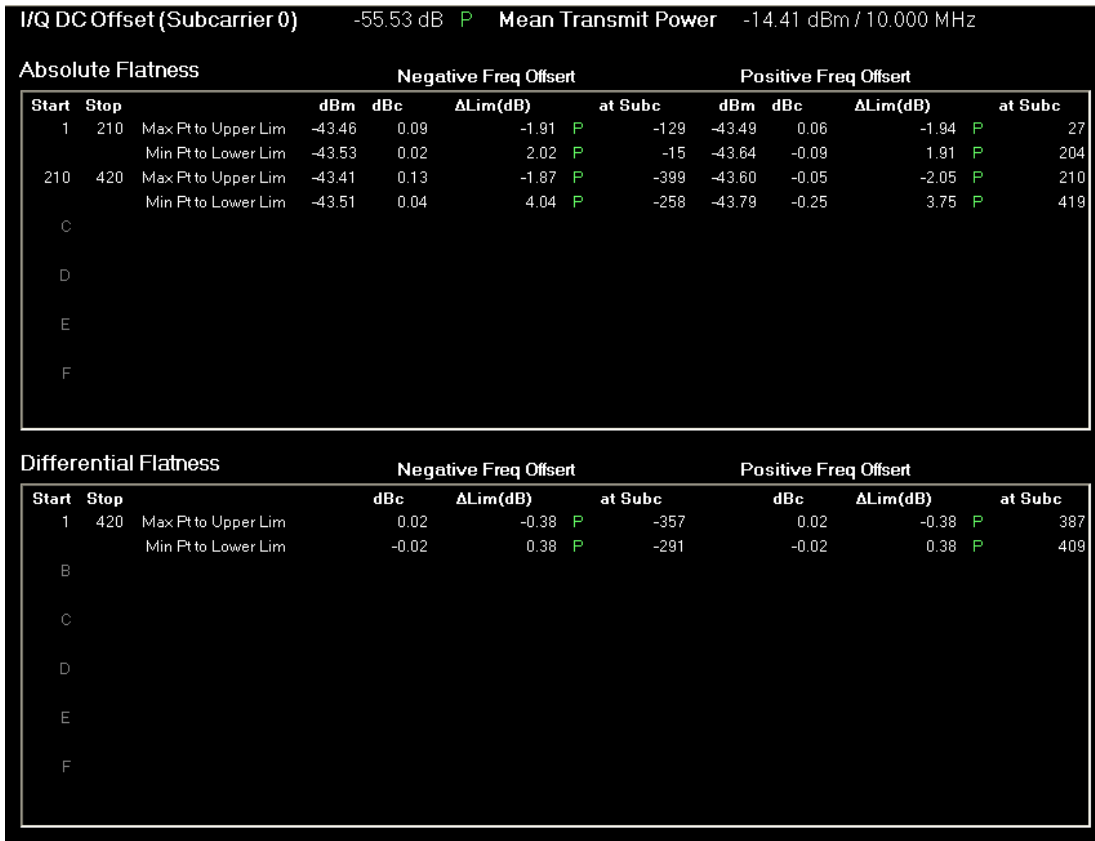

Figure 1 Zoomed Spectral Flatness Result Metrics Window

Name	Corresponding Results	Display Format
Transmit Power	n=1-46, Mean Transit Power in dBm n=1-47, Nominal BW in Hz	XX.XX dBm XX.XX Hz
<b>Absolute Flatness</b>		
Abs Max Subcarrier Power of Offset A, Lower Frequency Offset	n=21-1, Max Power in dBm n=21-2, Max Power in dBc n=21-3, Max Power to Upper Limit in dB n=21-4, Max Subcarrier Index	XX.XX XX.XX XX.XX XXX
Abs Min Subcarrier Power of Offset A, Lower Frequency Offset	n=21-5, Min Power in dBm n=21-6, Min Power in dBc n=21-7, Min Power to Lower Limit in dB n=21-8, Min Subcarrier Index	XX.XX XX.XX XX.XX XXX
Abs Max Subcarrier Power of Offset A, Upper Frequency Offset	n=21-9, Max Power in dBm n=21-10, Max Power in dBc n=21-11, Max Power to Upper Limit in dB n=21-12, Max Subcarrier Index	XX.XX XX.XX XX.XX XXX

Abs Min Subcarrier Power of Offset A, Upper Frequency Offset	n=21-13, Min Power in dBm n=21-14, Min Power in dBc n=21-15, Min Power to Lower Limit in dB n=21-16, Min Subcarrier Index	XX.XX XX.XX XX.XX XXX
Abs Max Subcarrier Power of Offset B, Lower Frequency Offset	n=21-17, Max Power in dBm n=21-18, Max Power in dBc n=21-19, Max Power to Upper Limit in dB n=21-20, Max Subcarrier Index	XX.XX XX.XX XX.XX XXX
Abs Min Subcarrier Power of Offset B, Lower Frequency Offset	n=21-21, Min Power in dBm n=21-22, Min Power in dBc n=21-23, Min Power to Lower Limit in dB n=21-24, Min Subcarrier Index	XX.XX XX.XX XX.XX XXX
Abs Max Subcarrier Power of Offset B, Upper Frequency Offset	n=21-25, Max Power in dBm n=21-26, Max Power in dBc n=21-27, Max Power to Upper Limit in dB n=21-28, Max Subcarrier Index	XX.XX XX.XX XX.XX XXX
Abs Min Subcarrier Power of Offset B, Upper Frequency Offset	n=21-29, Min Power in dBm n=21-30, Min Power in dBc n=21-31, Min Power to Lower Limit in dB n=21-32, Min Subcarrier Index	XX.XX XX.XX XX.XX XXX
Abs Max Subcarrier Power of Offset C, Lower Frequency Offset	n=21-33, Max Power in dBm n=21-34, Max Power in dBc n=21-35, Max Power to Upper Limit in dB n=21-36, Max Subcarrier Index	XX.XX XX.XX XX.XX XXX
Abs Min Subcarrier Power of Offset C, Lower Frequency Offset	n=21-37, Min Power in dBm n=21-38, Min Power in dBc n=21-39, Min Power to Lower Limit in dB n=21-40, Min Subcarrier Index	XX.XX XX.XX XX.XX XXX
Abs Max Subcarrier Power of Offset C, Upper Frequency Offset	n=21-41, Max Power in dBm n=21-42, Max Power in dBc n=21-43, Max Power to Upper Limit in dB n=21-44, Max Subcarrier Index	XX.XX XX.XX XX.XX XXX
Abs Min Subcarrier Power of Offset C,	n=21-45, Min Power in dBm	XX.XX XX.XX XX.XX XXX

Upper Frequency Offset	n=21–46, Min Power in dBc n=21–47, Min Power to Lower Limit in dB n=21–48, Min Subcarrier Index	
Abs Max Subcarrier Power of Offset D, Lower Frequency Offset	n=21–49, Max Power in dBm n=21–50, Max Power in dBc n=21–51, Max Power to Upper Limit in dB n=21–52, Max Subcarrier Index	XX.XX XX.XX XX.XX XXX
Abs Min Subcarrier Power of Offset D, Lower Frequency Offset	n=21–53, Min Power in dBm n=21–54, Min Power in dBc n=21–55, Min Power to Lower Limit in dB n=21–56, Min Subcarrier Index	XX.XX XX.XX XX.XX XXX
Abs Max Subcarrier Power of Offset D, Upper Frequency Offset	n=21–57, Max Power in dBm n=21–58, Max Power in dBc n=21–59, Max Power to Upper Limit in dB n=21–60, Max Subcarrier Index	XX.XX XX.XX XX.XX XXX
Abs Min Subcarrier Power of Offset D, Upper Frequency Offset	n=21–61, Min Power in dBm n=21–62, Min Power in dBc n=21–63, Min Power to Lower Limit in dB n=21–64, Min Subcarrier Index	XX.XX XX.XX XX.XX XXX
Abs Max Subcarrier Power of Offset E, Lower Frequency Offset	n=21–65, Max Power in dBm n=21–66, Max Power in dBc n=21–67, Max Power to Upper Limit in dB n=21–68, Max Subcarrier Index	XX.XX XX.XX XX.XX XXX
Abs Min Subcarrier Power of Offset E, Lower Frequency Offset	n=21–69, Min Power in dBm n=21–70, Min Power in dBc n=21–71, Min Power to Lower Limit in dB n=21–72, Min Subcarrier Index	XX.XX XX.XX XX.XX XXX
Abs Max Subcarrier Power of Offset E, Upper Frequency Offset	n=21–73, Max Power in dBm n=21–74, Max Power in dBc n=21–75, Max Power to Upper Limit in dB n=21–76, Max Subcarrier Index	XX.XX XX.XX XX.XX XXX
Abs Min Subcarrier Power of Offset E, Upper Frequency	n=21–77, Min Power in dBm n=21–78, Min Power in dBc	XX.XX XX.XX XX.XX XXX

Offset	n=21-79, Min Power to Lower Limit in dB n=21-80, Min Subcarrier Index	
Abs Max Subcarrier Power of Offset F, Lower Frequency Offset	n=21-81, Max Power in dBm n=21-82, Max Power in dBc n=21-83, Max Power to Upper Limit in dB n=21-84, Max Subcarrier Index	XX.XX XX.XX XX.XX XXX
Abs Min Subcarrier Power of Offset F, Lower Frequency Offset	n=21-85, Min Power in dBm n=21-86, Min Power in dBc n=21-87, Min Power to Lower Limit in dB n=21-88, Min Subcarrier Index	XX.XX XX.XX XX.XX XXX
Abs Max Subcarrier Power of Offset F, Upper Frequency Offset	n=21-89, Max Power in dBm n=21-90, Max Power in dBc n=21-91, Max Power to Upper Limit in dB n=21-92, Max Subcarrier Index	XX.XX XX.XX XX.XX XXX
Abs Min Subcarrier Power of Offset F, Upper Frequency Offset	n=21-93, Min Power in dBm n=21-94, Min Power in dBc n=21-95, Min Power to Lower Limit in dB n=21-96, Min Subcarrier Index	XX.XX XX.XX XX.XX XXX
Differential Flatness		
Differential Max Subcarrier Power of Offset A, Lower Frequency Offset	n=21-97, Max Power in dB n=21-98, Max Power to Upper Limit in dB n=21-99, Max Subcarrier Index	XX.XX XX.XX XXX
Differential Min Subcarrier Power of Offset A, Lower Frequency Offset	n=21-100, Min Power in dB n=21-101, Min Power to Lower Limit in dB n=21-102, Min Subcarrier Index	XX.XX XX.XX XXX
Differential Max Subcarrier Power of Offset A, Upper Frequency Offset	n=21-103, Max Power in dB n=21-104, Max Power to Upper Limit in dB n=21-105, Max Subcarrier Index	XX.XX XX.XX XXX
Differential Min Subcarrier Power of Offset A, Upper Frequency Offset	n=21-106, Min Power in dB n=21-107, Min Power to Lower Limit in dB n=21-108, Min Subcarrier Index	XX.XX XX.XX XXX
Differential Max Subcarrier Power of	n=21-109, Max Power in dB	XX.XX XX.XX XXX

Offset B, Lower Frequency Offset	n=21–110, Max Power to Upper Limit in dB n=21–111, Max Subcarrier Index	
Differential Min Subcarrier Power of Offset B, Lower Frequency Offset	n=21–112, Min Power in dB n=21–113, Min Power to Lower Limit in dB n=21–114, Min Subcarrier Index	XX.XX XX.XX XXX
Differential Max Subcarrier Power of Offset B, Upper Frequency Offset	n=21–115, Max Power in dB n=21–116, Max Power to Upper Limit in dB n=21–117, Max Subcarrier Index	XX.XX XX.XX XXX
Differential Min Subcarrier Power of Offset B, Upper Frequency Offset	n=21–118, Min Power in dB n=21–119, Min Power to Lower Limit in dB n=21–120, Min Subcarrier Index	XX.XX XX.XX XXX
Differential Max Subcarrier Power of Offset C, Lower Frequency Offset	n=21–121, Max Power in dB n=21–122, Max Power to Upper Limit in dB n=21–123, Max Subcarrier Index	XX.XX XX.XX XXX
Differential Min Subcarrier Power of Offset C, Lower Frequency Offset	n=21–124, Min Power in dB n=21–125, Min Power to Lower Limit in dB n=21–126, Min Subcarrier Index	XX.XX XX.XX XXX
Differential Max Subcarrier Power of Offset C, Upper Frequency Offset	n=21–127, Max Power in dB n=21–128, Max Power to Upper Limit in dB n=21–129, Max Subcarrier Index	XX.XX XX.XX XXX
Differential Min Subcarrier Power of Offset C, Upper Frequency Offset	n=21–130, Min Power in dB n=21–131, Min Power to Lower Limit in dB n=21–132, Min Subcarrier Index	XX.XX XX.XX XXX
Differential Max Subcarrier Power of Offset D, Lower Frequency Offset	n=21–133, Max Power in dB n=21–134, Max Power to Upper Limit in dB n=21–135, Max Subcarrier Index	XX.XX XX.XX XXX
Differential Min Subcarrier Power of Offset D, Lower Frequency Offset	n=21–136, Min Power in dB n=21–137, Min Power to Lower Limit in dB n=21–138, Min Subcarrier Index	XX.XX XX.XX XXX
Differential Max Subcarrier Power of Offset D, Upper	n=21–139, Max Power in dB n=21–140, Max Power to Upper Limit in dB	XX.XX XX.XX XXX

Frequency Offset	n=21-141, Max Subcarrier Index	
Differential Min Subcarrier Power of Offset D, Upper Frequency Offset	n=21-142, Min Power in dB n=21-143, Min Power to Lower Limit in dB n=21-144, Min Subcarrier Index	XX.XX XX.XX XXX
Differential Max Subcarrier Power of Offset E, Lower Frequency Offset	n=21-145, Max Power in dB n=21-146, Max Power to Upper Limit in dB n=21-147, Max Subcarrier Index	XX.XX XX.XX XXX
Differential Min Subcarrier Power of Offset E, Lower Frequency Offset	n=21-148, Min Power in dB n=21-149, Min Power to Lower Limit in dB n=21-150, Min Subcarrier Index	XX.XX XX.XX XXX
Differential Max Subcarrier Power of Offset E, Upper Frequency Offset	n=21-151, Max Power in dB n=21-152, Max Power to Upper Limit in dB n=21-153, Max Subcarrier Index	XX.XX XX.XX XXX
Differential Min Subcarrier Power of Offset E, Upper Frequency Offset	n=21-154, Min Power in dB n=21-155, Min Power to Lower Limit in dB n=21-156, Min Subcarrier Index	XX.XX XX.XX XXX
Differential Max Subcarrier Power of Offset F, Lower Frequency Offset	n=21-157, Max Power in dB n=21-158, Max Power to Upper Limit in dB n=21-159, Max Subcarrier Index	XX.XX XX.XX XXX
Differential Min Subcarrier Power of Offset F, Lower Frequency Offset	n=21-160, Min Power in dB n=21-161, Min Power to Lower Limit in dB n=21-162, Min Subcarrier Index	XX.XX XX.XX XXX
Differential Max Subcarrier Power of Offset F, Upper Frequency Offset	n=21-163, Max Power in dB n=21-164, Max Power to Upper Limit in dB n=21-165, Max Subcarrier Index	XX.XX XX.XX XXX
Differential Min Subcarrier Power of Offset F, Upper Frequency Offset	n=21-166, Min Power in dB n=21-167, Min Power to Lower Limit in dB n=21-168, Min Subcarrier Index	XX.XX XX.XX XXX

Key Path View/Display, More

Initial S/W Revision Prior to A.02.00

## Power vs. Time and Spectrum

Provides a combination view of a Power vs Time graph and a Power vs. Spectrum graph.

This view consists of 2 windows.

"Power vs Time Window" on page 1531

"Power vs Spectrum Window" on page 1531

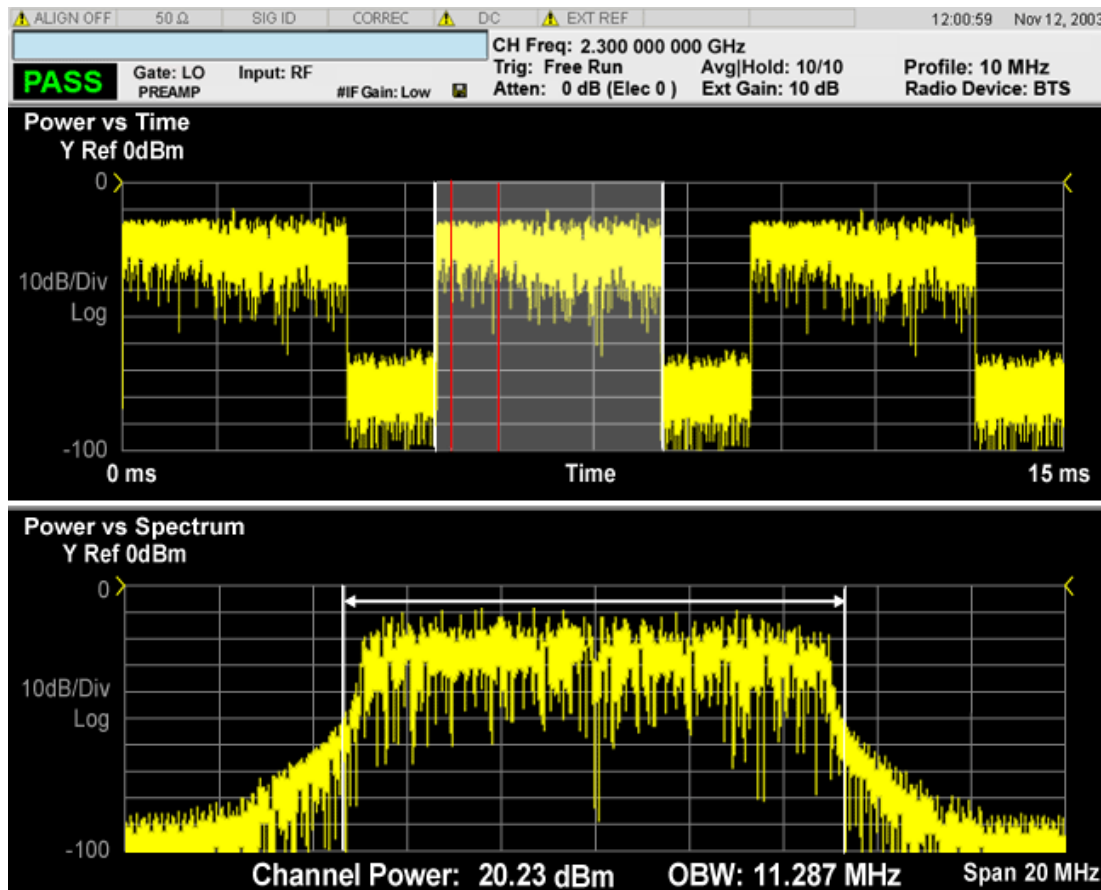

### Power vs Time Window

Marker Operation	Yes (Time – Power, support marker functions)
Corresponding Trace	n=20, Power vs Time

### Power vs Spectrum Window

Marker Operation	Yes (Time – Power, support marker functions)
Corresponding Trace	n=19, Power vs Spectrum
Annotations	When “OBW Line” is on, OBW

Name	Corresponding Results	Display Format
Channel Power, OBW	n=1-41, Channel Power in dBm n=1-42, OBW in Hz	XX.XX dBm XX.XXX Hz

Key Path	View/Display, More
Initial S/W Revision	Prior to A.02.00

## OBW Line

Displays OBW values and range. .

Key Path	View/Display, Power vs Spectrum
Mode	WIMAXOFDMA
<b>Remote Command</b>	:DISPlay:EVM:VIEW4:WINDow2:TRACe:OBW ON OFF 0 1 :DISPlay:EVM:VIEW4:WINDow2:TRACe:OBW?
<b>Example</b>	DISP:EVM:VIEW4:WIND2:TRAC:OBW ON DISP:EVM:VIEW4:WIND2:TRAC:OBW?
Preset	OFF
State Saved	Saved in instrument state.
Initial S/W Revision	Prior to A.02.00





This information is subject to change without notice.

© Keysight Technologies 2015

Edition 1, August 2015

M9420-90012

[www.keysight.com](http://www.keysight.com)